

# KOMFORT EC LB(E)

## Heat recovery air handling units

### Features

- Air handling units for efficient supply and exhaust ventilation in flats, houses, cottages and other buildings.
- Used to create controlled energy-saving ventilation systems.
- The heat recovery technology is used to minimize ventilation heat losses.
- Control of air exchange for creating comfortable indoor microclimate.
- Compatible with round Ø 160, 200 or 250 mm air ducts.



**Air flow:**  
up to 830 m<sup>3</sup>/h  
231 l/s



**Heat recovery efficiency:**  
up to 98 %



### Design

- The casing is made of double-skinned aluzinc panels, internally filled with mineral wool layer 40 mm for heat- and sound-insulation.
- The casing has mounting brackets with anti-vibration rubber mounts for easy installation.
- The unit is equipped with service hatches on the side panels for easy maintenance of filters. This design enables the left-hand and right-hand installation of the unit.
- The spigots are located at the sides of the unit and are equipped with rubber seals for airtight connection to the air ducts.

### Fans

- High-efficient external rotor EC motors and centrifugal impellers are used for air supply and exhaust.
- The forward curved blades in **KOMFORT EC LB(E) 300/LB(E) 400** provide permanent air flow.
- The **KOMFORT EC LB(E) 700** model has impellers with backward curved blades.
- EC motors have the best power consumption to air capacity ratio and meet the latest demands concerning energy saving and high-efficient ventilation.
- EC motors are featured with high performance, low noise level and totally controllable speed range.
- The impellers are dynamically balanced.

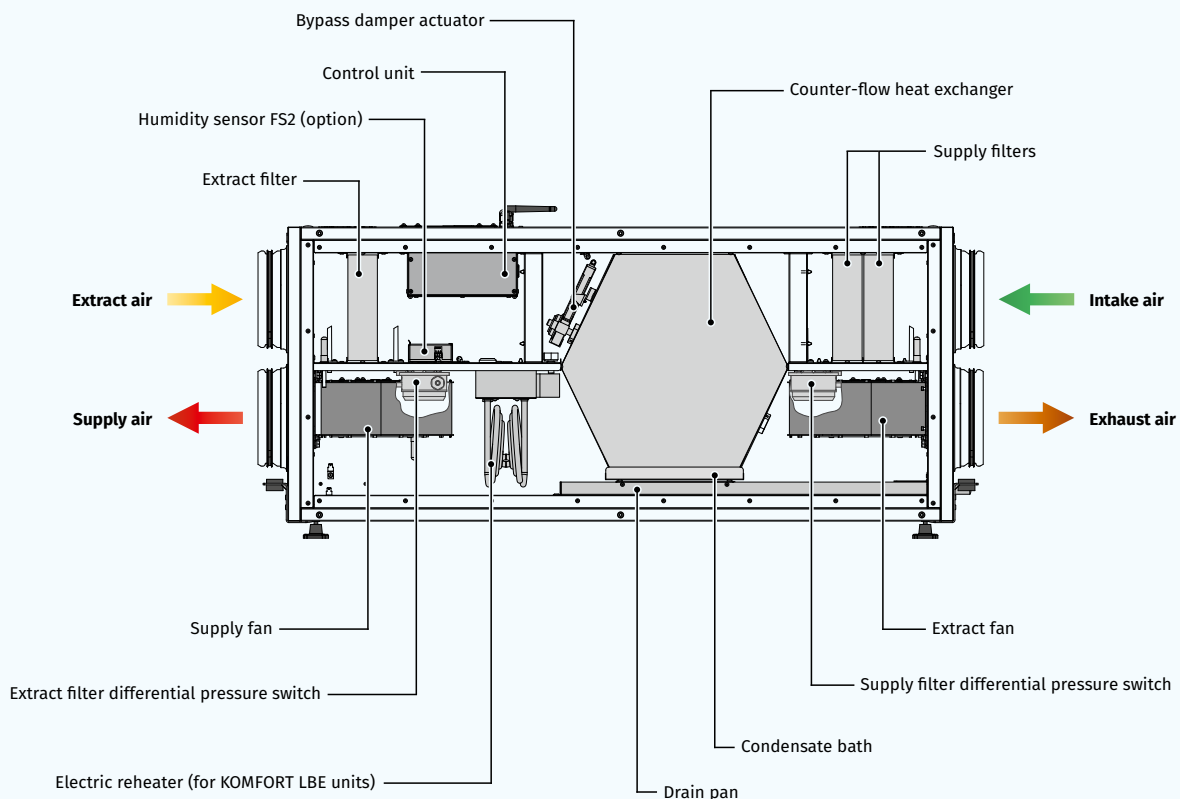

### Heat recovery

- o The **KOMFORT EC LB(E)...** unit is equipped with a plate counter-flow polystyrene heat exchanger for heat recovery. The unit condensate is collected and drained to the drain pan under the heat exchanger.



- o The **KOMFORT EC LB(E)....-E** unit is equipped with an enthalpy plate counter-flow heat exchanger for energy (heat and humidity) recovery. Due to humidity recovery condensate is not generated in the enthalpy heat exchanger.



- o The air flows are completely separated in the heat exchanger. Thus smells and contaminants are not transferred from the extract air to the supply air.
- o Heat recovery is based on heat and/or humidity transfer through the heat exchanger plates. In the cold season supply air is heated in the heat exchanger by transferring the heat energy of warm and humid extract air to the cold fresh air. Heat recovery minimizes ventilation heat losses and heating costs respectively.
- o In the warm season the heat exchanger performs reverse and intake air is cooled in the heat exchanger by the cool extract air. That reduces operation load on air conditioners and saves electricity.

### Air filtration

- o Two built-in G4 and F7 filters provide efficient supply air filtration.
- o The G4 filter is used for extract air filtration.

### Air heater

- o The **KOMFORT EC LBE S21** units are equipped with an electric heater for additional heating of supply air downstream of the heat exchanger.
- o The **KOMFORT EC LB S21** units are not equipped with built-in heaters but both a preheater and a reheater can be purchased separately.

### Bypass

- o The **KOMFORT EC LB(E) S21** model is equipped with a bypass which is automatically opened in summer if there is a need to cool down the ventilated area with cool intake air.
- o If the unit is equipped with an electric heater, the bypass is used for freeze protection of the heat exchanger.

### Mounting

- o Mounting on floor or ceiling with fixing brackets.
- o The correctly mounted unit must provide condensate collecting and drainage as well as access to service mounting and filter replacement.

### Control and automation

- o **KOMFORT EC LB... S21** units are equipped with an integrated automation system. The remote control panel is not included in the delivery set (purchased separately).
- o The S21 controller allows to integrate the unit into the **Smart Home** system or **BMS (Building Management System)**.
- o The unit can be controlled via the **Blauberg AHU** mobile application via Wi-Fi.





Download the **Blauberg AHU** app for Android

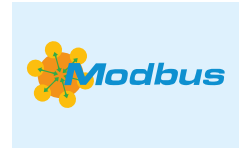

Download the **Blauberg AHU** app for iOS



## Automation functions

Functions	KOMFORT EC LB(E) S21
Unit control via Wi-Fi using a mobile application	+
Unit control via a wired remote control panel	S22 control panel (option) 
Unit control via a wireless remote control panel	S22 Wi-Fi control panel (option) 
Unit control via a wired remote LCD control panel	S25 control panel (option) 
BMS (Building Management System)	RS-485
	Wi-Fi
	Ethernet
	MODBUS (RTU, TCP)
Blauberg Cloud Server service	+
Speed selection	+
Filter replacement indication	by hour meter readings
Alarm indication	by filter clogging differential pressure switch
Week-scheduled operation	full alarm description in the mobile application
By-pass	+
	automatic
	manual
Timer	+
Boost mode	+
Fireplace mode	+
Freeze protection	through cyclic stops of the supply fan
	through preheating (option)
	using a bypass
Reheater connection	option
Preheater connection	option
Minimum supply air temperature control	+
Humidity control	option
CO <sub>2</sub> control	option
VOC control	option
PM2.5 control	option
Fire alarm sensor connection	option

Option: function is available when purchasing the appropriate accessory (see the "Accessories" section).

## Designation key

Series	Motor type	Spigot modification	Bypass	Heater type	Rated air flow, [m <sup>3</sup> /h]	Heat exchanger type	Control
KOMFORT	EC: electronically commutated motor	L: horizontal spigot orientation	B: with a bypass	_: without a heater E: electric heater	300; 400; 700	_: heat recovery -E: energy recovery	S21

## Dimensions [mm]

Model	∅ D	B	B1	H	L	L1
KOMFORT EC LB 300(-E) S21	157	566	480	479	1083	1180
KOMFORT EC LBE 300(-E) S21	157	566	480	479	1083	1180
KOMFORT EC LB 400(-E) S21	197	682	596	504	1094	1191
KOMFORT EC LBE 400(-E) S21	197	682	596	504	1094	1191
KOMFORT EC LB 700(-E) S21	247	866	700	601	1282	1379
KOMFORT EC LBE 700(-E) S21	247	866	700	601	1282	1379

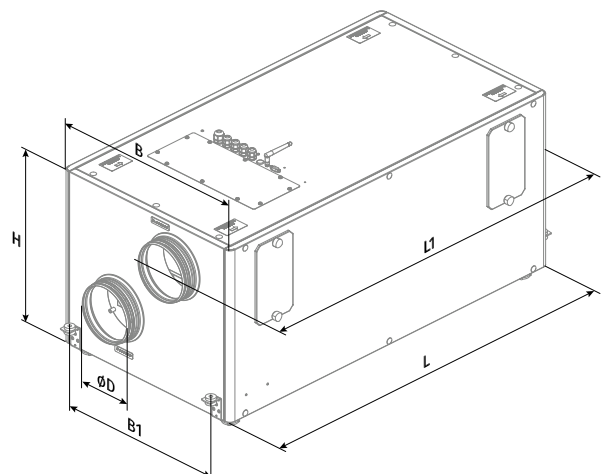

### Technical data

Parameters	KOMFORT EC LB 300 S21	KOMFORT EC LBE 300 S21	KOMFORT EC LB 300-E S21	KOMFORT EC LBE 300-E S21
Voltage [V / 50 (60) Hz]	1~ 230	1~ 230	1~ 230	1~ 230
Power (without a heater) [W]	182	182	182	182
Current (without a heater) [A]	1.4	1.4	1.4	1.4
Electric heater power [W]	-	2800	-	2800
Electric heater current [A]	-	12.2	-	12.2
Power (with a heater) [W]	182	2982	182	2982
Current (with a heater) [A]	1.4	13.6	1.4	13.6
Maximum air flow [m³/h (l/s)]	380 (106)	380 (106)	380 (106)	380 (106)
Sound pressure level at a distance of 3 m [dBA]	24	24	24	24
Transported air temperature [°C]	-25...+40	-25...+40	-25...+40	-25...+40
Casing material	galvanized steel	galvanized steel	galvanized steel	galvanized steel
Insulation	40 mm mineral wool	40 mm mineral wool	40 mm mineral wool	40 mm mineral wool
Extract filter	G4	G4	G4	G4
Supply filter	G4+F7	G4+F7	G4+F7	G4+F7
Connected air duct diameter [mm]	160	160	160	160
Weight [kg]	63.1	64.3	63.1	64.3
Heat recovery efficiency [%]	80–98	80–98	74–89	74–89
Heat exchanger type	counter-flow	counter-flow	counter-flow	counter-flow
Heat exchanger material	polystyrene	polystyrene	enthalpy	enthalpy
SEC class	A+	A+	A	A

Sound power level, A-weighted	Total	Octave band [Hz]								LpA 3 m	LpA 1 m
		63	125	250	500	1000	2000	4000	8000		
L <sub>WA</sub> to supply inlet [dBA]	67	50	55	56	62	60	62	56	50		
L <sub>WA</sub> to supply outlet [dBA]	53	42	47	46	46	44	39	29	21		
L <sub>WA</sub> to exhaust inlet [dBA]	68	56	54	61	62	59	61	56	50		
L <sub>WA</sub> to exhaust outlet [dBA]	55	42	47	51	48	46	43	31	22		
L <sub>WA</sub> to environment [dBA]	45	34	35	40	39	32	36	31	27	24	34

\*Data for point 1 in the performance diagram

Point	Power [W]	Sound pressure level at 3 m distance [dBA]
1	155	24 (34)
2	143	23 (33)
3	119	23 (33)
4	61	20 (30)
5	56	20 (30)
6	46	20 (30)
7	20	13 (23)
8	19	13 (23)
9	18	13 (23)

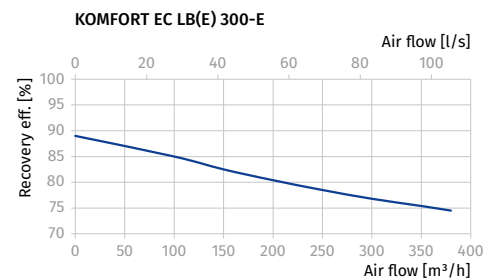
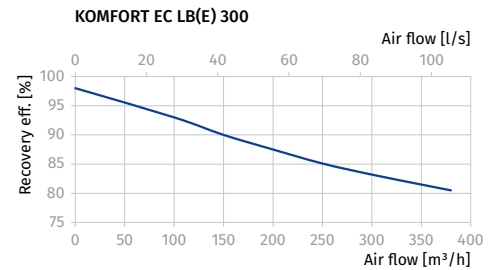
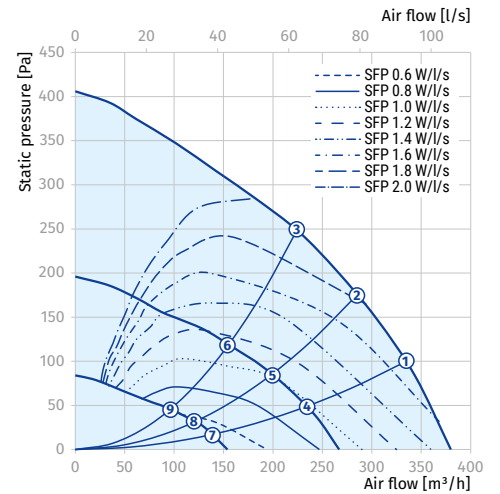

HEAT RECOVERY AIR HANDLING UNITS

Parameters	KOMFORT EC LB 400 S21	KOMFORT EC LBE 400 S21	KOMFORT EC LB 400-E S21	KOMFORT EC LBE 400-E S21
Voltage [V / 50 (60) Hz]	1~ 230	1~ 230	1~ 230	1~ 230
Power (without a heater) [W]	289	289	289	289
Current (without a heater) [A]	2.1	2.1	2.1	2.1
Electric heater power [W]	-	2800	-	2800
Electric heater current [A]	-	12.2	-	12.2
Power (with a heater) [W]	289	3089	289	3089
Current (with a heater) [A]	2.1	14.3	2.1	14.3
Maximum air flow [m <sup>3</sup> /h (l/s)]	540 (150)	540 (150)	540 (150)	540 (150)
Sound pressure level at a distance of 3 m [dBA]	27	27	27	27
Transported air temperature [°C]	-25...+40	-25...+40	-25...+40	-25...+40
Casing material	galvanized steel	galvanized steel	galvanized steel	galvanized steel
Insulation	40 mm mineral wool	40 mm mineral wool	40 mm mineral wool	40 mm mineral wool
Extract filter	G4	G4	G4	G4
Supply filter	G4+F7	G4+F7	G4+F7	G4+F7
Connected air duct diameter [mm]	200	200	200	200
Weight [kg]	74.8	76	74.8	76
Heat recovery efficiency [%]	84-98	84-98	78-89	78-89
Heat exchanger type	counter-flow	counter-flow	counter-flow	counter-flow
Heat exchanger material	polystyrene	polystyrene	enthalpy	enthalpy
SEC class	A+	A+	A	A

Sound power level, A-weighted	Total	Octave band [Hz]								LpA 3 m	LpA 1 m
		63	125	250	500	1000	2000	4000	8000		
L <sub>WA</sub> to supply inlet [dBA]	71	52	57	57	68	64	64	59	53		
L <sub>WA</sub> to supply outlet [dBA]	56	44	49	47	52	47	41	31	24		
L <sub>WA</sub> to exhaust inlet [dBA]	70	52	56	60	66	62	64	60	53		
L <sub>WA</sub> to exhaust outlet [dBA]	58	39	49	52	53	49	46	35	24		
L <sub>WA</sub> to environment [dBA]	48	32	37	40	45	36	38	35	30	27	37

\*Data for point 1 in the performance diagram

Point	Power [W]	Sound pressure level at 3 m distance [dBA]
1	240	27 (37)
2	215	26 (36)
3	196	26 (36)
4	89	21 (31)
5	80	21 (31)
6	72	20 (30)
7	27	19 (29)
8	26	19 (29)
9	24	17 (27)

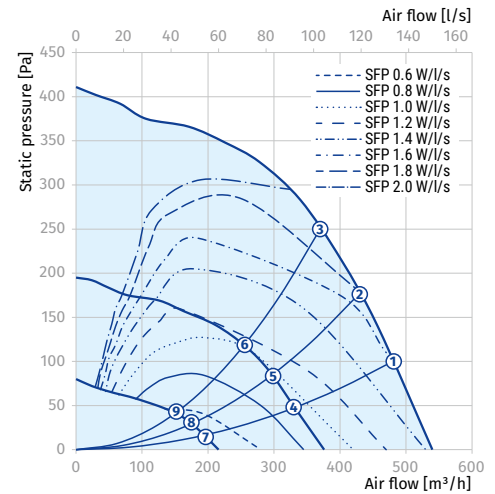

KOMFORT EC LB(E) 400

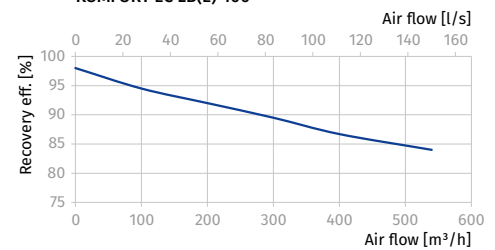

KOMFORT EC LB(E) 400-E

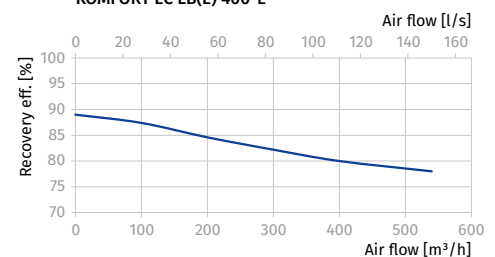

Parameters	KOMFORT EC LB 700 S21	KOMFORT EC LBE 700 S21	KOMFORT EC LB 700-E S21	KOMFORT EC LBE 700-E S21
Voltage [V / 50 (60) Hz]	1~ 230	1~ 230	1~ 230	1~ 230
Power (without a heater) [W]	336	336	336	336
Current (without a heater) [A]	2.4	2.4	2.4	2.4
Electric heater power [W]	-	3600	-	3600
Electric heater current [A]	-	15.6	-	15.6
Power (with a heater) [W]	336	3936	336	3936
Current (with a heater) [A]	2.4	18.0	2.4	18.0
Maximum air flow [m³/h (l/s)]	830 (231)	830 (231)	830 (231)	830 (231)
Sound pressure level at a distance of 3 m [dBA]	31	31	31	31
Transported air temperature [°C]	-25...+40	-25...+40	-25...+40	-25...+40
Casing material	galvanized steel	galvanized steel	galvanized steel	galvanized steel
Insulation	40 mm mineral wool	40 mm mineral wool	40 mm mineral wool	40 mm mineral wool
Extract filter	G4	G4	G4	G4
Supply filter	G4+F7	G4+F7	G4+F7	G4+F7
Connected air duct diameter [mm]	250	250	250	250
Weight [kg]	107	108.4	107	108.4
Heat recovery efficiency [%]	80-98	80-98	74-89	74-89
Heat exchanger type	counter-flow	counter-flow	counter-flow	counter-flow
Heat exchanger material	polystyrene	polystyrene	enthalpy	enthalpy
SEC class	A+	A+	A	A

Sound power level, A-weighted	Total	Octave band [Hz]								LpA 3 m	LpA 1 m
		63	125	250	500	1000	2000	4000	8000		
L <sub>WA</sub> to supply inlet [dBA]	76	56	61	61	73	69	69	64	57		
L <sub>WA</sub> to supply outlet [dBA]	60	49	53	52	56	51	44	34	26		
L <sub>WA</sub> to exhaust inlet [dBA]	74	56	60	65	70	66	68	64	56		
L <sub>WA</sub> to exhaust outlet [dBA]	61	42	53	56	56	52	49	37	25		
L <sub>WA</sub> to environment [dBA]	51	35	40	43	49	39	40	37	32	31	41





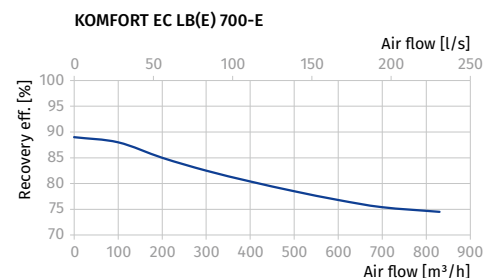
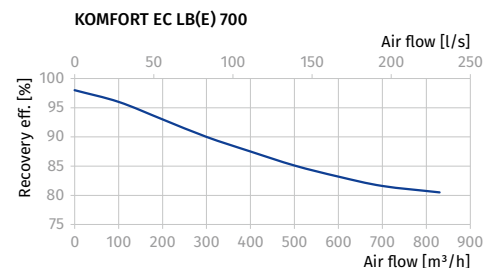
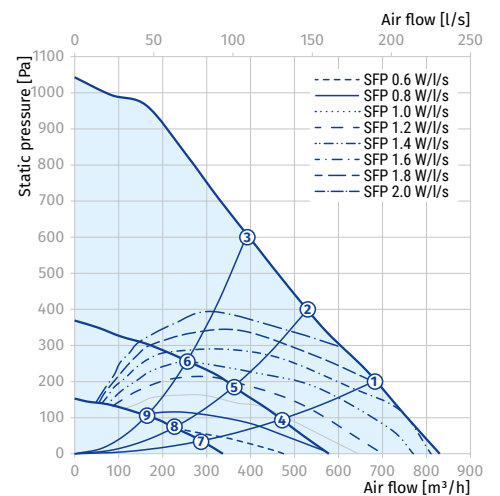











\*Data for point 1 in the performance diagram

















Point	Power [W]	Sound pressure level at 3 m distance [dBA]
1	336	31 (41)
2	336	30 (40)
3	336	29 (39)
4	123	25 (35)
5	115	25 (35)
6	96	24 (34)
7	41	23 (33)
8	38	23 (33)
9	36	20 (30)



HEAT RECOVERY AIR HANDLING UNITS

**Accessories**

		KOMFORT EC LB 300(-E) S21	KOMFORT EC LBE 300(-E) S21	KOMFORT EC LB 400(-E) S21
Panel filter G4		FP 484x178x48 G4	FP 484x178x48 G4	FP 600x205x48 G4
Panel filter F7		FP 484x178x48 F7	FP 484x178x48 F7	FP 600x205x48 F7
Control panel		S22	S22	S22
Wireless control panel		S22 Wi-Fi	S22 Wi-Fi	S22 Wi-Fi
LCD control panel		S25	S25	S25
Indoor humidity sensor		FS2	FS2	FS2
CO <sub>2</sub> sensor with indication		CD-1	CD-1	CD-1
CO <sub>2</sub> sensor		CD-2	CD-2	CD-2
Humidity sensor		HR-S	HR-S	HR-S
Reheater		ENH 160 S21 V.2	-	ENH 200 S21 V.2
Preheater		EVH 160 S21 V.2	EVH 160 S21 V.2	EVH 200 S21 V.2
Silencer		SD 160	SD 160	SD 200
Non-return valve		VRV 160	VRV 160	VRV 200
Air damper		VKA 160	VKA 160	VKA 200
Drain pump		CP-2	CP-2	CP-2
Air damper actuator		TF230	TF230	TF230

		KOMFORT EC LBE 400(-E) S21	KOMFORT EC LB 700(-E) S21	KOMFORT EC LBE 700(-E) S21
Panel filter G4		FP 600x205x48 G4	FP 784x253x48 G4	FP 784x253x48 G4
Panel filter F7		FP 600x205x48 F7	FP 784x253x48 F7	FP 784x253x48 F7
Control panel		S22	S22	S22
Wireless control panel		S22 Wi-Fi	S22 Wi-Fi	S22 Wi-Fi
LCD control panel		S25	S25	S25
Indoor humidity sensor		FS2	FS2	FS2
CO <sub>2</sub> sensor with indication		CD-1	CD-1	CD-1
CO <sub>2</sub> sensor		CD-2	CD-2	CD-2
Humidity sensor		HR-S	HR-S	HR-S
Reheater		-	ENH 250 S21 V.2	-
Preheater		EVH 200 S21 V.2	EVH 250 S21 V.2	EVH 250 S21 V.2
Silencer		SD 200	SD 250	SD 250
Non-return valve		VRV 200	VRV 250	VRV 250
Air damper		VKA 200	VKA 250	VKA 250
Drain pump		CP-2	CP-2	CP-2
Air damper actuator		TF230	TF230	TF230