

Centro-MZ

Inline centrifugal fans

Use

- Supply and extract ventilation systems installed in various premises.
- Direct mounting inside air ductworks.
- Compatible with Ø 100 up to 315 mm round air ducts.



Air flow:
up to 1540 m³/h
428 l/s



Power:
from 60 W



Noise level:
from 35 dBA



Design

- Galvanized steel casing.
- Aerodynamically shaped casing.
- External terminal block for power supply.

Motor

- Single-phase external rotor motor with a centrifugal impeller with backward curved blades.
- Equipped with ball bearings for longer service life.
- Integrated thermal protection.
- Dynamically balanced impeller.
- For ventilation of premises with high requirements to noise level low-noise modifications are available (**Centro-MZ L**).

Speed control

- Smooth speed control with an external thyristor controller or step speed control with an external auto transformer (both available upon separate order).

Mounting

- Any mounting position.
- Wall or ceiling mounting with fixing brackets supplied as a standard.
- Flexible air ducts are fixed on the fan spigots with clamps.

Modifications and options

- max:** high-powered motor.
- L:** low-powered and low-noise motor.
- W1:** power cable with mains plug.

Designation key

Series	Duct diameter [mm]	Motor modifications	Options
Centro-MZ	100; 125; 150; 160; 200; 250; 315	max: high-powered motor L: low-powered motor	W1: power cable with mains plug

Dimensions [mm]

Type	Ø D	Ø D1	B	B1	L	L1	L2	L3
Centro-MZ 100 (L)	99	245	259	299	190	20	20	30
Centro-MZ 125 (L)	124	245	259	299	190	20	20	30
Centro-MZ 150	149	274	290	330	170	20	20	30
Centro-MZ 150 max	149	345	355	395	230	20	20	40
Centro-MZ 160	159	274	290	330	170	20	20	30
Centro-MZ 200 (L)	198	345	355	395	245	25	25	40
CENTRO-MZ 200 MAX	198	345	355	395	245	25	25	40
Centro-MZ 250	248	345	355	395	245	25	25	40
Centro-MZ 315 (L)	313	405	415	455	245	30	25	40

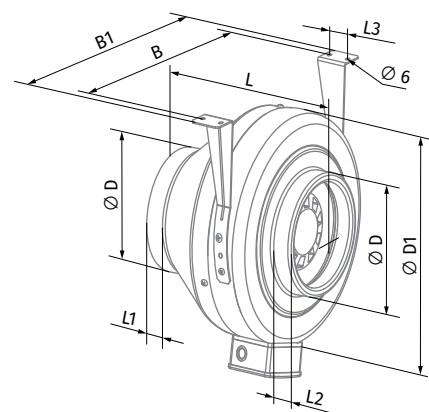

Accessories

Silencers	Filter boxes	Electric heaters	Water heaters	Backdraft air dampers	Air dampers	Clamps	Speed controllers
SD	KFBK	KFBT	EKH	WKH	VRV	VK / VKA	K
							CDT1 E
							CDT E1.8
							CDTE E... TP

Technical data

Parameters	Centro-MZ 100 L		Centro-MZ 100		Centro-MZ 125 L		Centro-MZ 125	
Voltage [V]	1 ~ 220-240		1 ~ 220-240		1 ~ 220-240		1 ~ 220-240	
Frequency [Hz]	50	60	50	60	50	60	50	60
Power [W]	42	51	62	77	40	51	62	77
Current [A]	0.19	0.23	0.28	0.34	0.19	0.23	0.28	0.34
Maximum air flow [m³/h (l/s)]	230 (64)	250 (69)	250 (69)	265 (74)	320 (89)	360 (100)	350 (97)	380 (106)
RPM [min⁻¹]	2732	3258	2812	3294	2762	3220	2752	3194
Sound pressure at 3 m [dBA]	44	45	46	47	43	44	46	46
Transported air temperature [°C]	-25...+55	-25...+50	-25...+55	-25...+50	-25...+55	-25...+50	-25...+55	-25...+50
SEC class	C		C		C		C	
IP rating	IPX4		IPX4		IPX4		IPX4	
Motor IP rating	IP44		IP44		IP44		IP44	
ErP	2018		2018		2018		2018	

To comply with ErP 2018 it is necessary to use a speed controller and local demand control typology (connect the sensor).

CENTRO-MZ 100 L, CENTRO-MZ 100

Sound power level, A-weighted	Total	Octave frequency bands [Hz]							
		63	125	250	500	1000	2000	4000	8000
Centro-MZ 100 L									
LWA to inlet [dBA]	63	51	57	56	57	51	46	40	29
LWA to outlet [dBA]	65	54	62	58	61	57	50	45	33
LWA to environment [dBA]	55	19	14	21	34	42	41	29	17
Centro-MZ 100									
LWA to inlet [dBA]	72	47	67	68	67	60	54	53	42
LWA to outlet [dBA]	73	56	67	72	66	63	58	57	42
LWA to environment [dBA]	64	43	60	57	41	24	6	17	24

CENTRO-MZ 125 L, CENTRO-MZ 125

Sound power level, A-weighted	Total	Octave frequency bands [Hz]							
		63	125	250	500	1000	2000	4000	8000
Centro-MZ 125 L									
LWA to inlet [dBA]	59	31	52	54	53	49	46	35	30
LWA to outlet [dBA]	61	35	53	56	60	51	49	35	34
LWA to environment [dBA]	64	46	60	59	43	33	15	30	28
Centro-MZ 125									
LWA to inlet [dBA]	75	56	63	68	69	64	61	52	41
LWA to outlet [dBA]	75	58	71	74	72	65	65	56	47
LWA to environment [dBA]	64	52	64	59	48	36	23	30	27

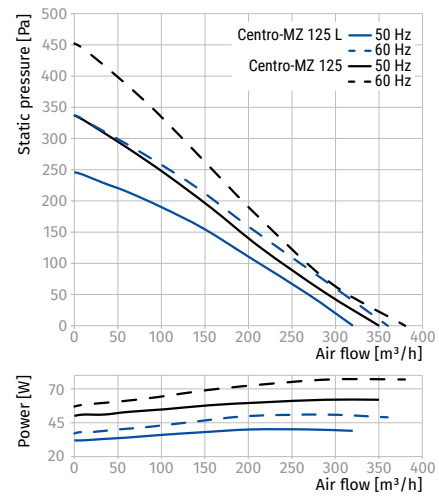
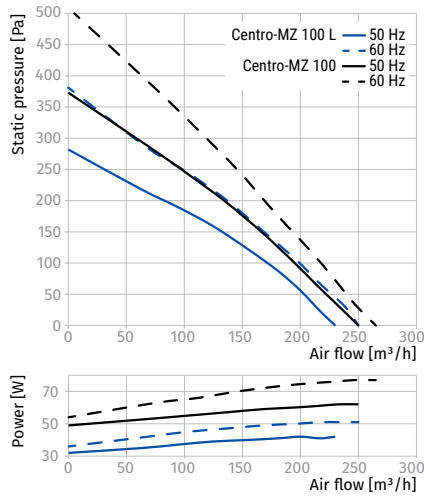

Parameters	Centro-MZ 150		Centro-MZ 150 max		Centro-MZ 160		Centro-MZ 200 L		Centro-MZ 200		Centro-MZ 200 max	
Voltage [V]	1 ~ 220-240		1 ~ 220-240		1 ~ 220-240		1 ~ 220-240		1 ~ 220-240		1 ~ 220-240	
Frequency [Hz]	50	60	50	60	50	60	50	60	50	60	50	60
Power [W]	64	78	127	174	64	78	130	174	144	193	186	240
Current [A]	0.29	0.34	0.56	0.77	0.29	0.35	0.56	0.77	0.63	0.85	0.81	1.05
Maximum air flow [m³/h (l/s)]	455 (125)	475 (132)	710 (197)	750 (208)	450 (125)	485 (135)	900 (250)	970 (269)	1000 (278)	1045 (290)	1110 (308)	1140 (317)
RPM [min ⁻¹]	2780	3216	2760	3144	2750	3186	2814	3558	2824	3164	2810	3222
Sound pressure at 3 m [dBA]	44	45	48	49	46	46	48	49	50	50	50	50
Transported air temperature [°C]	-25...+50		-25...+60		-25...+50		-25...+50		-25...+50		-25...+50	
SEC class	B		B		B		B		B		B	
IP rating	IPX4		IPX4		IPX4		IPX4		IPX4		IPX4	
Motor IP rating	IP44		IP44		IP44		IP 44		IP 44		IP 44	
ErP	2018		2018		2018		2018		2018		2018	

To comply with ErP 2018 it is necessary to use a speed controller and local demand control typology (connect the sensor).

CENTRO-MZ 150, CENTRO-MZ 150 MAX

Sound power level, A-weighted	Total	Octave frequency bands [Hz]							
		63	125	250	500	1000	2000	4000	8000
Centro-MZ 150									
LWA to inlet [dBA]	88	60	76	83	81	83	79	75	63
LWA to outlet [dBA]	87	63	75	72	81	82	81	76	62
LWA to environment [dBA]	65	28	46	55	58	61	57	49	36
Centro-MZ 150 max									
LWA to inlet [dBA]	94	56	91	90	79	78	75	71	57
LWA to outlet [dBA]	94	56	92	89	76	75	69	68	55
LWA to environment [dBA]	68	29	51	61	63	63	63	52	39

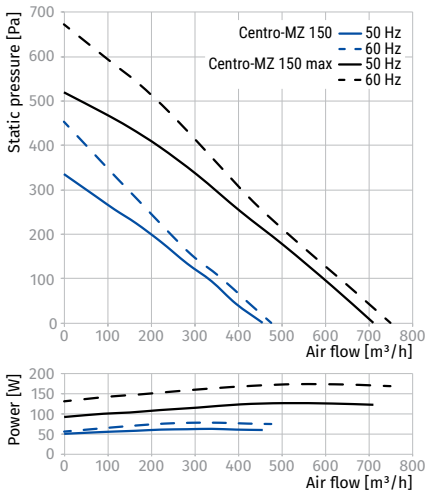

CENTRO-MZ 200 L

Sound power level, A-weighted	Total	Octave frequency bands [Hz]							
		63	125	250	500	1000	2000	4000	8000
LWA to inlet [dBA]	76	47	68	65	70	67	59	58	50
LWA to outlet [dBA]	76	49	71	69	72	63	63	60	53
LWA to environment [dBA]	64	46	61	57	48	32	27	48	42

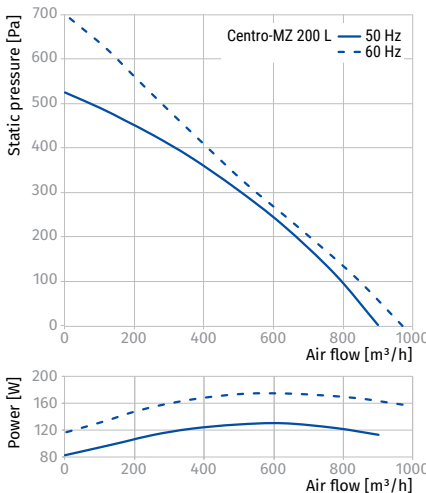

CENTRO-MZ 160

Sound power level, A-weighted	Total	Octave frequency bands [Hz]							
		63	125	250	500	1000	2000	4000	8000
LWA to inlet [dBA]	69	42	67	66	63	61	58	48	35
LWA to outlet [dBA]	72	46	69	65	68	64	63	50	40
LWA to environment [dBA]	60	41	60	53	36	20	18	30	24

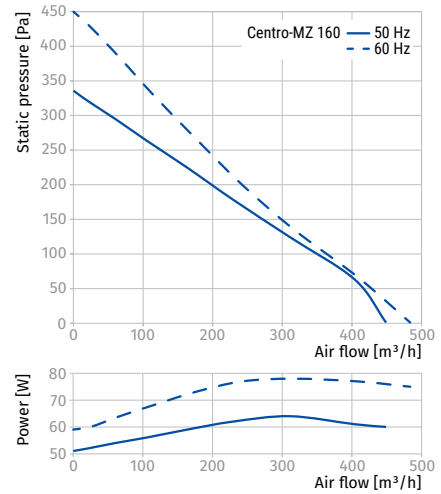

CENTRO-MZ 200, CENTRO-MZ 200 MAX

Sound power level, A-weighted	Total	Octave frequency bands [Hz]							
		63	125	250	500	1000	2000	4000	8000
Centro-MZ 200									
LWA to inlet [dBA]	73	51	66	68	71	67	64	58	52
LWA to outlet [dBA]	79	51	73	69	74	67	65	60	50
LWA to environment [dBA]	68	47	64	64	46	32	30	44	42
Centro-MZ 200 max									
LWA to inlet [dBA]	95	56	92	91	79	78	75	72	57
LWA to outlet [dBA]	94	56	92	89	75	74	69	68	54
LWA to environment [dBA]	70	29	52	62	64	64	64	53	39

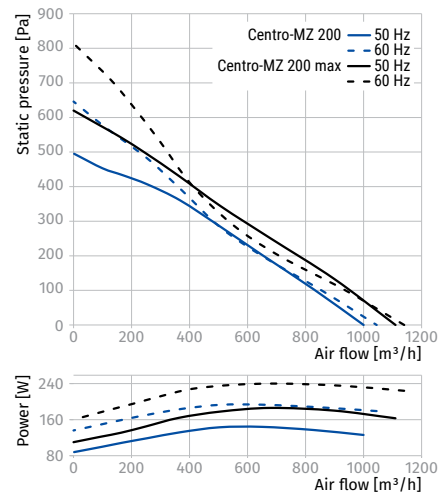

Parameters	Centro-MZ 250		Centro-MZ 315	
Voltage [V]	1 ~ 220-240		1 ~ 220-240	
Frequency [Hz]	50	60	50	60
Power [W]	152	202	185	238
Current [A]	0.66	0.88	0.81	1.04
Maximum air flow [m³/h (l/s)]	1070 (297)	1100 (306)	1540 (428)	1580 (439)
RPM [min⁻¹]	2765	2560	2730	2870
Sound pressure at 3 m [dBA]	52	52	53	54
Transported air temperature [°C]	-25...+50	-25...+50	-25...+45	-25...+45
SEC class	B		-	
IP rating	IPX4		IPX4	
Motor IP rating	IP44		IP44	
ErP	2018		2018	

To comply with ErP 2018 it is necessary to use a speed controller and local demand control typology (connect the sensor).

CENTRO-MZ 250

Sound power level, A-weighted	Total	Octave frequency bands [Hz]							
		63	125	250	500	1000	2000	4000	8000
L _{WA} to inlet [dBA]	75	60	66	67	67	67	63	56	45
L _{WA} to outlet [dBA]	76	60	73	71	69	65	66	59	46
L _{WA} to environment [dBA]	65	58	62	60	47	43	40	47	36

CENTRO-MZ 315

Sound power level, A-weighted	Total	Octave frequency bands [Hz]							
		63	125	250	500	1000	2000	4000	8000
L _{WA} to inlet [dBA]	77	53	66	71	69	68	66	63	60
L _{WA} to outlet [dBA]	78	58	71	74	72	71	71	63	63
L _{WA} to environment [dBA]	70	55	66	61	57	48	54	56	51

