

VENTO EXPERT DUO A30-1 S10 W V.2

HEAT RECOVERY SINGLE-ROOM UNITS

Features

- Arrangement of balanced energy saving, supply and exhaust, single-room ventilation in kitchen, bathroom and utility rooms.
- Reducing heat losses caused by ventilation due to heat recovery.
- Humidity balance and controllable air exchange create individually controlled microclimate.
- Wi-Fi data exchange between several single-room ventilation units for coordinated operation.
- Controlled by Android or iOS smartphone or tablet.



Air flow:
up to 30 m³/h
8 l/s



Heat recovery efficiency:
up to 85 %



Power: from 2.17 W
SFP: from 0.66 W/l/s



Noise level:
from 24 dBA



Dear partners! Please note that as of the end of the third quarter of 2020, in order to increase the efficiency of the Vento Expert Duo, the company manufactures products with regenerators divided into two sections.

Design

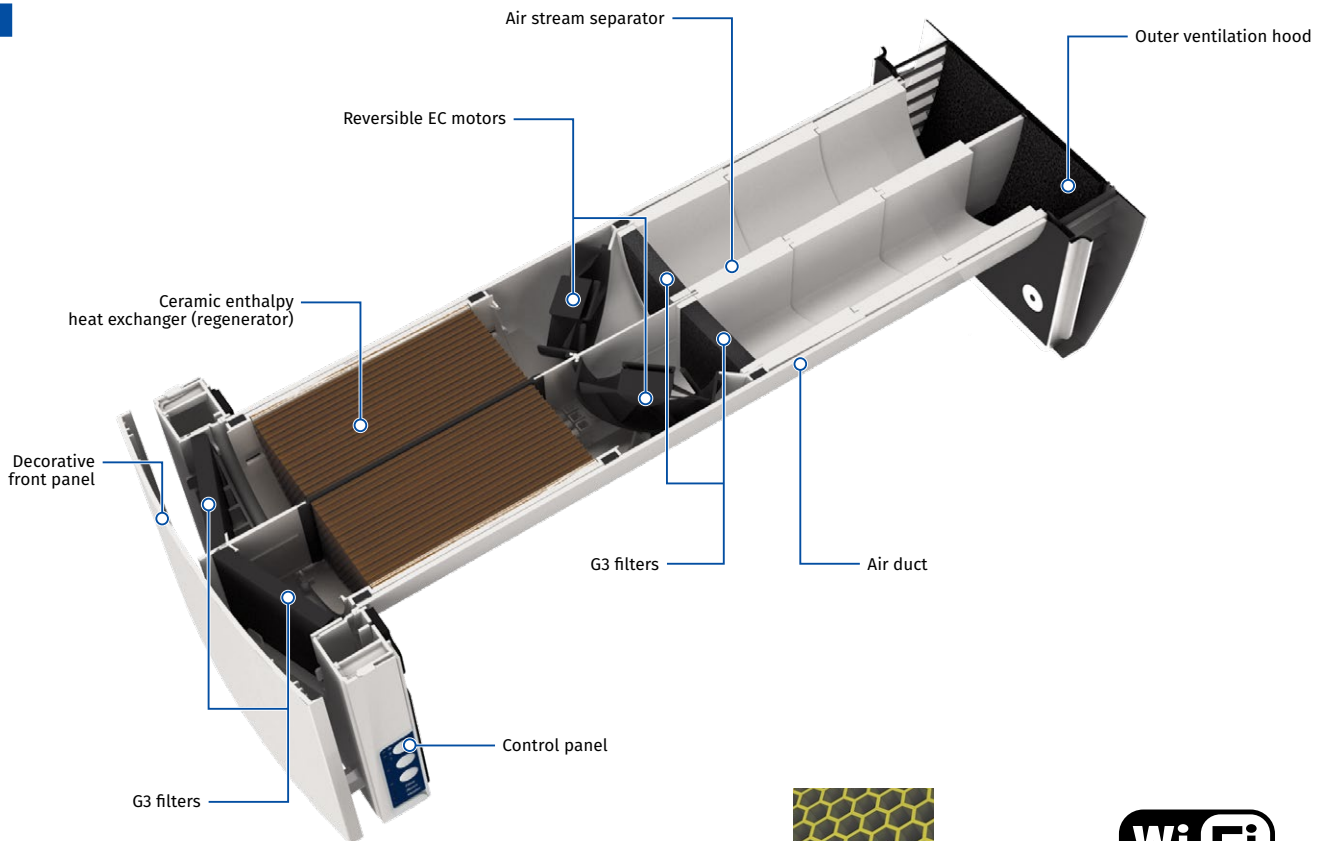

One of the best regeneration efficiency on the market due to innovative hexagonal structure of the heat exchanger cells



Built-in Wi-Fi for wireless communication between units and Android or iOS device control

Designation key

Model	Fans	Air duct	Rated air flow [m ³ /h]	Front panel	Ventilation hood type	Control
Vento Expert	Duo: two fans with different rotation direction	A: round air duct	30	-1: flat front panel	S10: white plastic hood AH-10 white 160 Duo	W V.2: control and setup of the unit with the Wi-Fi mobile application

VENTO EXPERT DUO A30-1 S10 W V.2

HEAT RECOVERY SINGLE-ROOM UNITS

Control

- Unit control via smartphone or tablet application.
- The units can be connected via Wi-Fi for synchronized operation.
- House ventilation control via cloud service from anywhere in the world.
- Connection to smart house or Building Management System (BMS) via Wi-Fi.

Blauberg Vento V.2 app for Android or iOS devices is available at Google Play and App Store.

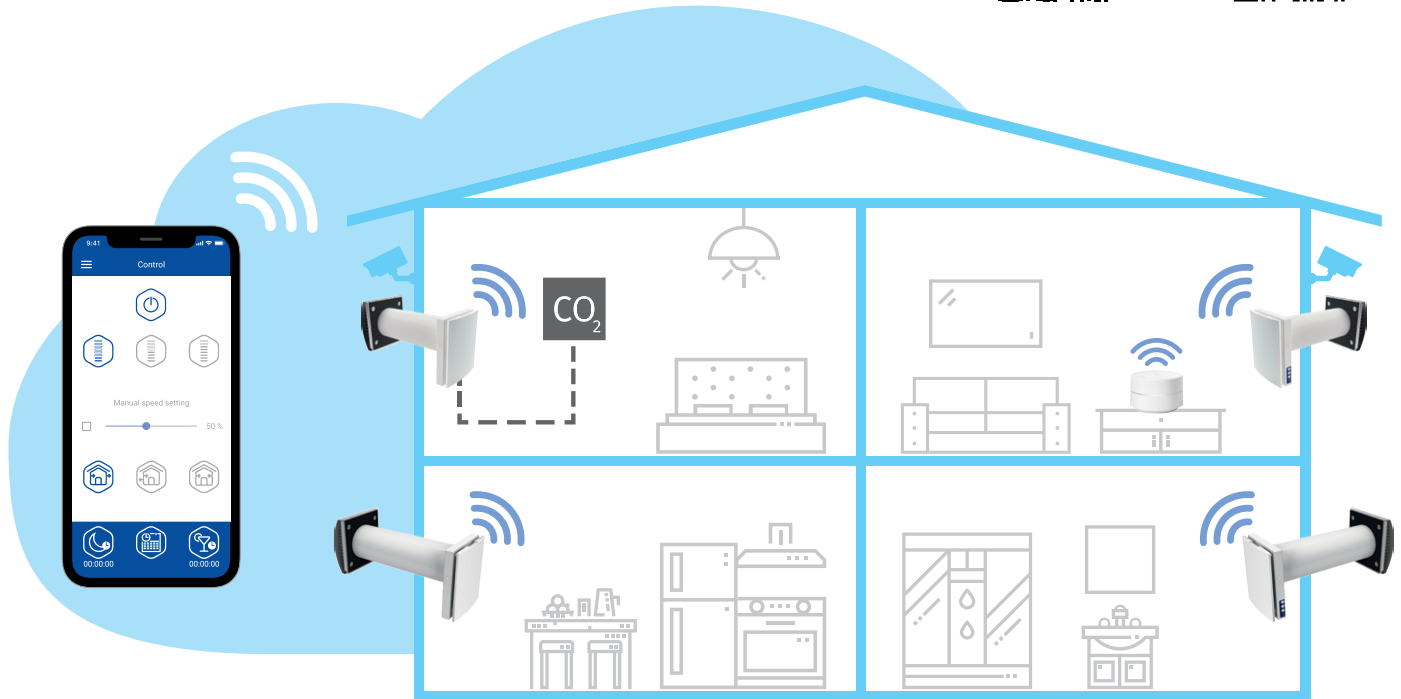

Vento Expert Duo either can operate as independent unit or can be connected with other units in a house and controlled with a master unit. In this case, only the master unit receives a signal from the remote control.

Control of the unit operation mode is also performed by means of the sensor control panel located on the unit casing or the remote control.

FOR LIVING ROOMS AND BEDROOMS



FOR KITCHEN AND BATHROOM

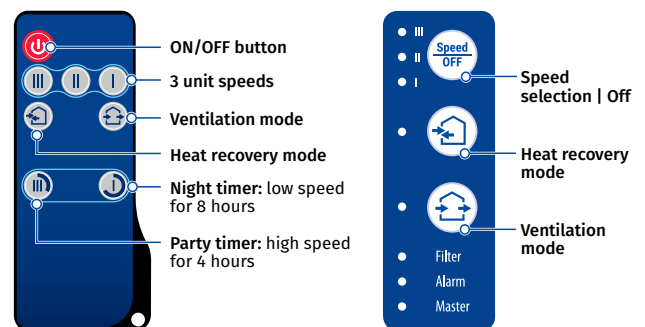

Vento Expert is equipped with a humidity sensor for indoor humidity control. If humidity increases above a set point, the unit boosts to the speed III.

VENTO EXPERT DUO A30-1 S10 W V.2

HEAT RECOVERY SINGLE-ROOM UNITS

Heat and humidity recovery

UNIT OPERATING LOGIC IN WINTER PERIOD

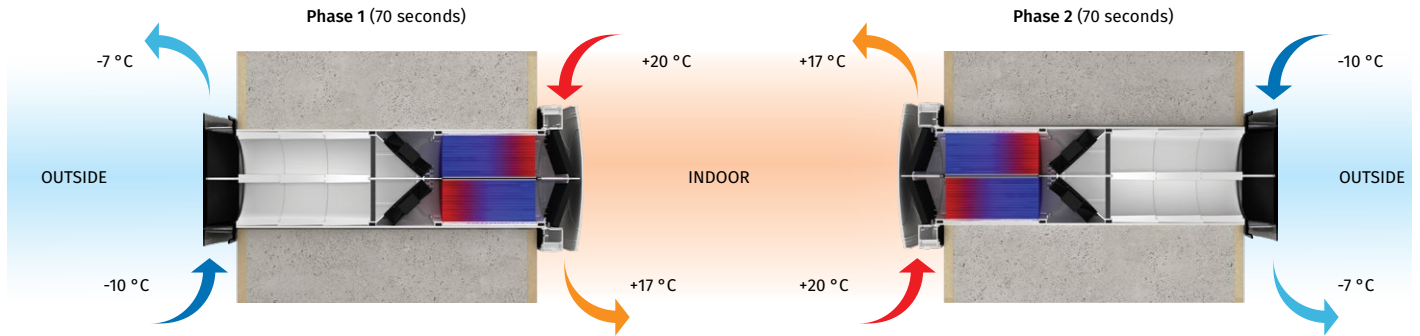

- To increase the efficiency of the Vento Expert Duo, the regenerator is divided into two parts, which are isolated from one another, thus eliminating the transfer of heat and moisture between them.
- One of the fans operates in the supply mode: fresh cold intake air from outside flows through the first regenerator, and absorbs accumulated heat and humidity.
- At the same time, the other fan operates in the exhaust mode: warm stale air is extracted from the room to the outside, and while passing through the other regenerator, gradually heats it up and transfers some of the moisture.
- After 70 seconds operation the fans change the rotation direction and opposite processes start.

Mounting

- **Vento Expert** units should be installed in the living room and bedrooms while **Vento Expert Duo** units should be installed in kitchen, bathrooms and utility rooms.
- The unit is designed for through-the-wall installation inside a prepared hole in an outer wall of the building.

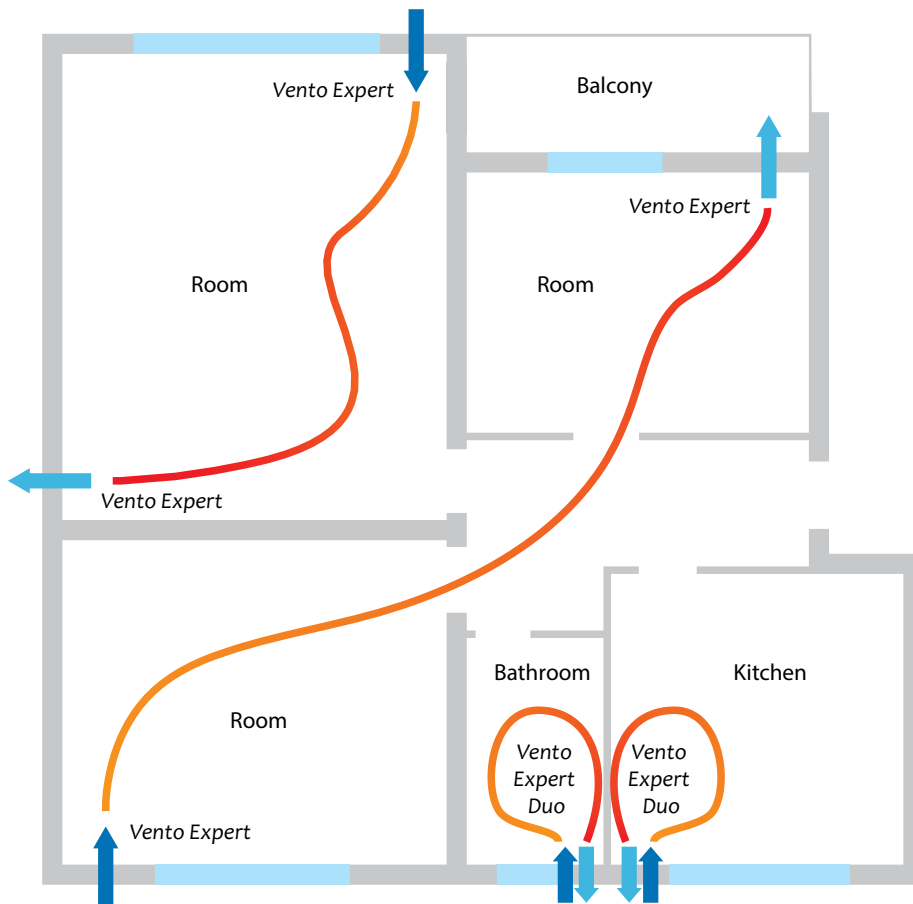

VENTO EXPERT DUO A30-1 S10 W V.2

HEAT RECOVERY SINGLE-ROOM UNITS

Technical data

Parameters	Vento Expert Duo A30-1 S10 W V.2		
	I	II	III
Speed			
Voltage [V / 50 (60) Hz]		100-240	
Power [W]	2.17	3.66	6.62
Current [A]	0.026	0.039	0.066
RPM [min ⁻¹]	1600	2200	2500
Air flow [m ³ /h (l/s)]	10 (3)	20 (6)	30 (8)
Air flow in humidity extract mode [m ³ /h (l/s)]		60 (16)	
SFP [W/l/s]	0.78	0.66	0.79
Filter		G3	
Transported air temperature [°C]		-15...+40	
Sound pressure level at 1 m in accordance with ISO 3741:2004 [dBA]	33	40	43
Sound pressure level at 3 m in accordance with ISO 3741:2004 [dBA]	24	31	34
Outdoor sound pressure attenuation in accordance with DIN EN 20140 [dBA]		42	
Indoor/outdoor airtightness classification of the complete unit in accordance with EN 13141-8		D2	
Heat recovery efficiency in accordance with DIBt LÜ-A 20 [%]		up to 85	
Ingress protection rating		IP24	

ENERG
енергия · ενεργεια
Y IA
IE 1A

BLAUBERG Vento Expert Duo A30-1 S10 W V.2

A+

A

B

C

D

E

F

G

A

51 dB

30 m³/h

ENERGIA · ЕНЕРГИЯ · ΕΝΕΡΓΕΙΑ · ENERGIA · ENERGY · ENERGIE · ENERGI
2020 1254/2014

Overall dimensions [mm]

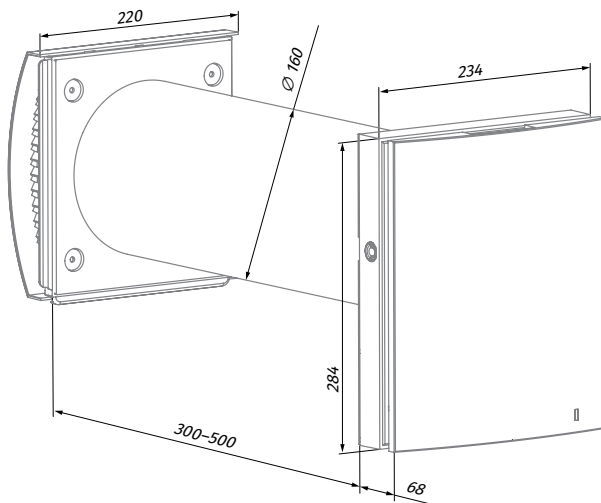











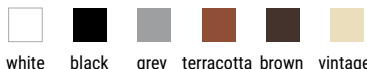

Vento Expert Duo A30-1 S10 W V.2

VENTO EXPERT DUO A30-1 S10 W V.2



HEAT RECOVERY SINGLE-ROOM UNITS

Accessories

Name		Description
FP Vento Expert Duo A30 G3		G3 filter set. Includes: • Rectangular filter G3 (2 pcs.) • Semicircular filter G3 (2 pcs.)
FP1 Vento Expert Duo A30 G3		G3 filter set. Includes: • Rectangular filter G3 (2 pcs.) • Semicircular filter G3 (2 pcs.) • Plastic filter holder (2 pcs.)
AH-10 *colour* 160 Duo		Plastic outer ventilation hood. Available in colours: 
AH-10 chrome 160 Duo		Plastic outer ventilation hood with a plate with brushed stainless steel effect finish
AH-5 white 160 Duo		Stainless steel ventilation hood, painted white
AH-5 chrome 160 Duo		Brushed stainless steel ventilation hood
PP 160/0.5		Outer ventilation hood for mounting from inside
R 160-500		500 mm air duct and polystyrene foam plug
R 160-700		700 mm air duct and polystyrene foam plug
LST Vento Expert Duo		Air stream separator
SE Vento Expert W		Sensor control panel
FB Vento Expert A50		Remote control
CD-1		CO ₂ sensor with LED CO ₂ indication and a sensor button for operation mode selection

VENTO EXPERT DUO A30-1 S10 W V.2

HEAT RECOVERY SINGLE-ROOM UNITS

Name	Description
CD-2	 CO ₂ sensor
S Vento Expert A30	 Cardboard template for indoor installation of the unit