

VENTO EXPERT DUO A30-1 S10 PRO

HEAT RECOVERY SINGLE-ROOM UNITS

Features

- Arrangement of efficient energy-saving supply and exhaust single-room ventilation in flats, houses, cottages, social and commercial premises.
- Reducing heat losses caused by ventilation due to heat recovery.
- Humidity balance and regulated air exchange create individually controlled microclimate.
- Coordinated network based on several integrated single-room ventilation units with central control.



Air flow:
up to 30 m³/h
8 l/s



Heat recovery efficiency:
up to 85 %



Power: from 2.00 W
SFP: from 0.67 W/l/s



Noise level:
from 24 dBA



Dear partners! Please note that as of the end of the third quarter of 2020, in order to increase the efficiency of the Vento Expert Duo, the company manufactures products with regenerators divided into two sections.



Design

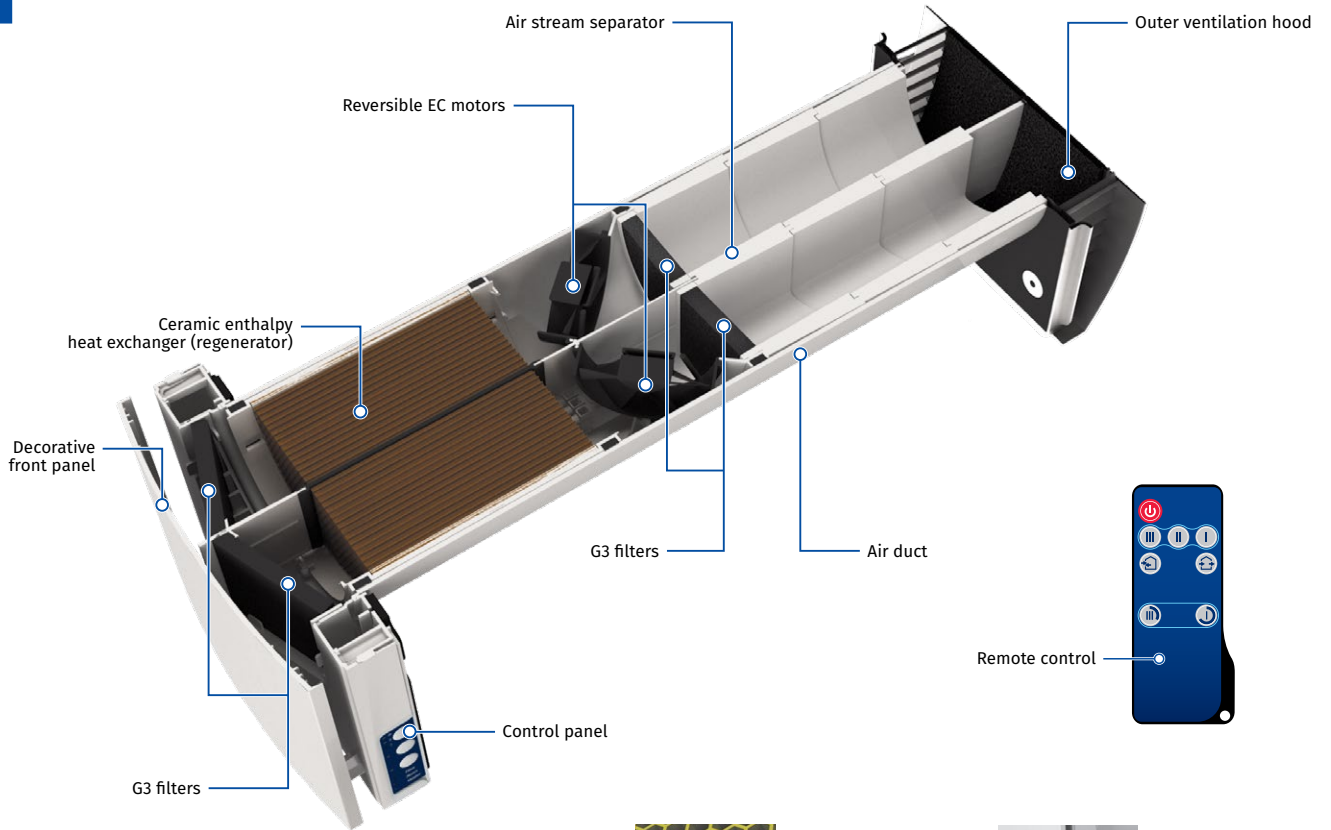

One of the best regeneration efficiency on the market due to innovative hexagonal structure of the heat exchanger cells



Easy maintenance. Indoor unit is opened by pressing the latches on both sides

Designation key

Model	Fans	Air duct	Rated air flow [m ³ /h]	Front panel	Ventilation hood type	Control
Vento Expert	Duo: two fans with different rotation direction	A: round air duct	30	-1: flat front panel	S10: white plastic hood AH-10 white 160 Duo	Pro: control with touch buttons and a remote control

VENTO EXPERT DUO A30-1 S10 PRO

HEAT RECOVERY SINGLE-ROOM UNITS

Heat and humidity regeneration

UNIT OPERATING LOGIC IN WINTER PERIOD

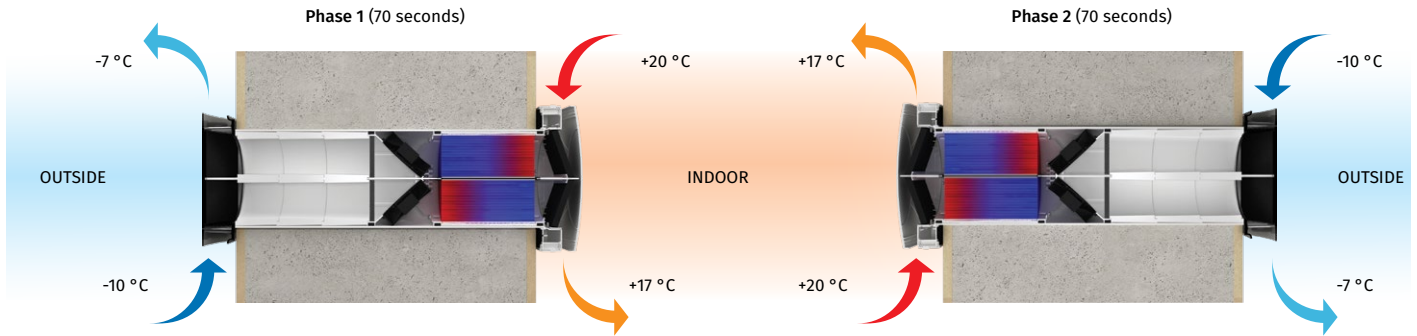

- o To increase the efficiency of the Vento Expert Duo, the regenerator is divided into two parts, which are isolated from one another, thus eliminating the transfer of heat and moisture between them.
- o One of the fans operates in the supply mode: fresh cold intake air from outside flows through the first regenerator, and absorbs accumulated heat and humidity.

- o At the same time, the other fan operates in the exhaust mode: warm stale air is extracted from the room to the outside, and while passing through the other regenerator, gradually heats it up and transfers some of the moisture.
- o After 70 seconds operation the fans change the rotation direction and opposite processes start.

Control

- o Control of the unit operation mode is performed by means of the sensor control panel located on the unit casing or the remote controller.

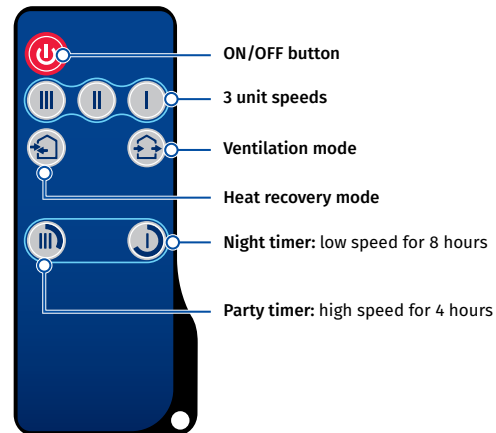
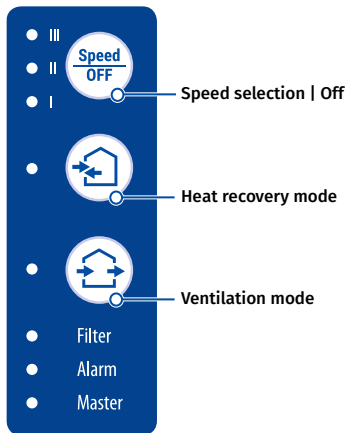

Vento Expert Duo either can operate as independent unit or can be wired with other units in a house and controlled with a master unit. In this case, only the master unit receives a signal from the remote control.

Vento Expert Duo is equipped with a humidity sensor for indoor humidity control. If humidity increases above a set point, the unit boosts to the speed III.

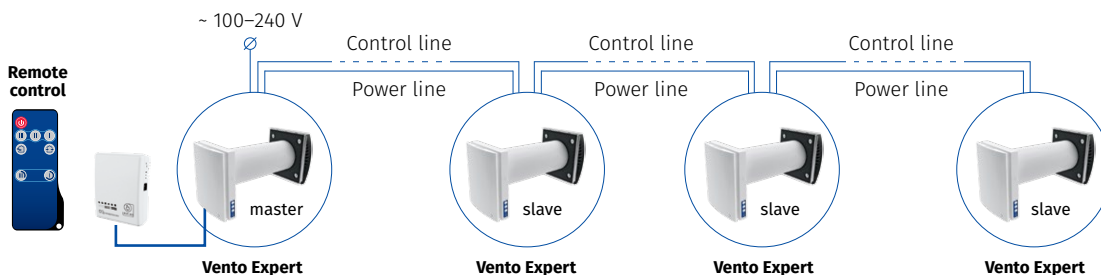

VENTO EXPERT DUO A30-1 S10 PRO

HEAT RECOVERY SINGLE-ROOM UNITS

Mounting

- **Vento Expert Duo** must be installed in each room with high humidity like kitchen, bathroom to be ventilated while Vento Expert must be installed in each living room to be ventilated.
- The unit is designed for through-the-wall installation inside a prepared core hole in an outer wall of the building.

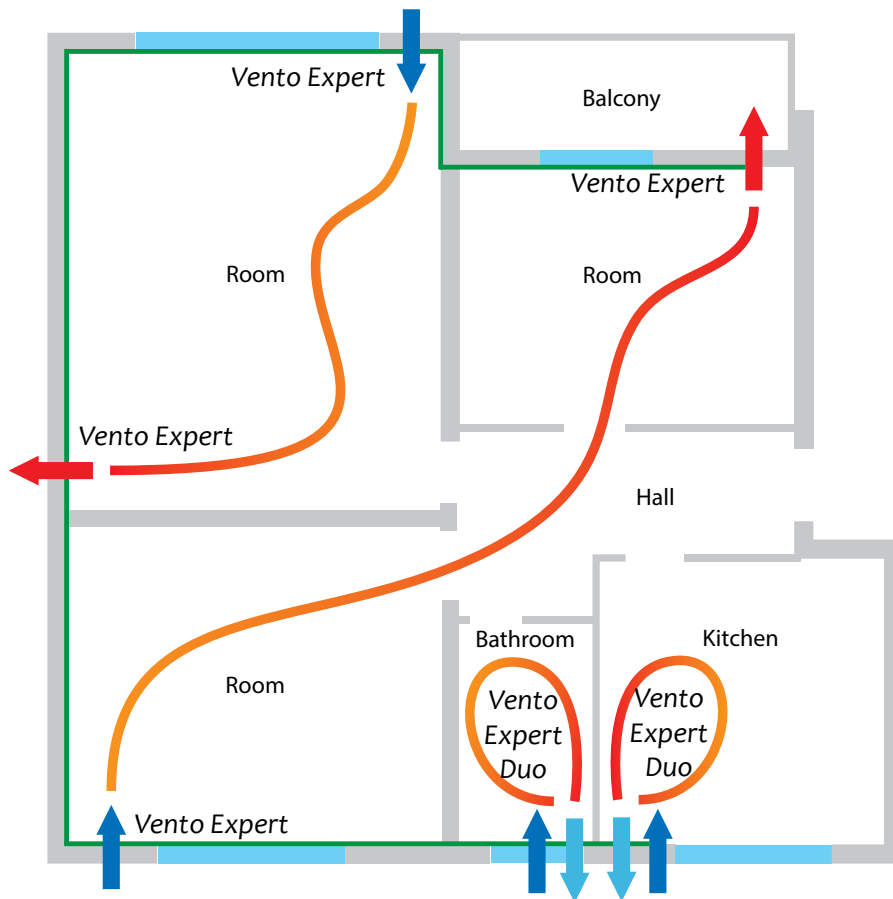

VENTO EXPERT DUO A30-1 S10 PRO

HEAT RECOVERY SINGLE-ROOM UNITS

Technical data

Parameters	Vento Expert Duo A30-1 S10 Pro		
	I	II	III
Speed			
Voltage [V / 50 (60) Hz]		100-240	
Power [W]	2.00	3.70	6.40
Current [A]	0.027	0.043	0.067
RPM [min ⁻¹]	1600	2200	2500
Air flow [m ³ /h (l/s)]	10 (3)	20 (6)	30 (8)
Air flow in humidity extract mode [m ³ /h (l/s)]		60 (16)	
SFP [W/l/s]	0.72	0.67	0.77
Filter		G3	
Transported air temperature [°C]		-15...+40	
Sound pressure level at 1 m [dBA]	33	40	43
Sound pressure level at 3 m [dBA]	24	31	34
Outdoor sound pressure attenuation [dBA] in accordance with DIN EN 20140		42	
Indoor/outdoor airtightness classification of the complete unit in accordance with EN 13141-8		D2	
Heat recovery efficiency according to DIBt LÚ-A 20 [%]		up to 85	
Ingress protection rating		IP24	

ENERG
енергия · ενεργεια
Y IA
IE IA

BLAUBERG Vento Expert Duo A30-1 S10 Pro

A+

A

B

C

D

E

F

G

A

51 dB

30 m³/h

ENERGIA · ЕНЕРГИЯ · ΕΝΕΡΓΕΙΑ · ENERGIA · ENERGY · ENERGIE · ENERGI
2020 1254/2014

Overall dimensions [mm]

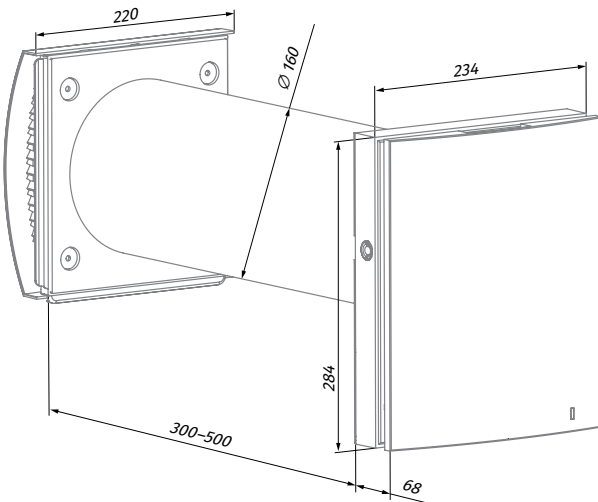















Vento Expert Duo A30-1 S10 Pro

VENTO EXPERT DUO A30-1 S10 PRO

HEAT RECOVERY SINGLE-ROOM UNITS

Accessories

Name		Description
FP Vento Expert Duo A30 G3		G3 filter set. Includes: • Rectangular filter G3 (2 pcs.) • Semicircular filter G3 (2 pcs.)
FP1 Vento Expert Duo A30 G3		G3 filter set. Includes: • Rectangular filter G3 (2 pcs.) • Semicircular filter G3 (2 pcs.) • Plastic filter holder (2 pcs.)
AH-10 *colour* 160 Duo		Plastic outer ventilation hood. Available in colours: 
AH-10 chrome 160 Duo		Plastic outer ventilation hood with a plate with brushed stainless steel effect finish
AH-5 white 160 Duo		Stainless steel outer ventilation hood, painted white
AH-5 chrome 160 Duo		Outer ventilation hood made of brushed stainless steel
PP 160/0.5		Outer ventilation hood for mounting from inside
LST Vento Expert Duo		Air stream separator
R 160-500		500 mm air duct and plastic foam plug
R 160-700		700 mm air duct and plastic foam plug
FB Vento Expert A50		Remote control
CD-1		CO ₂ sensor with LED CO ₂ indication and a sensor button for operation mode selection
CD-2		CO ₂ sensor