

VENTO ECO A50-4 S11 PRO

HEAT RECOVERY SINGLE-ROOM UNITS

Features

- Arrangement of efficient energy-saving supply and exhaust single-room ventilation in flats, houses, cottages, social and commercial premises.
- Air purification with optional F8 filter PM2.5 > 99 %.
- Protection from outdoor noise.
- Reducing heat losses caused by ventilation due to heat recovery.
- Humidity balance and regulated air exchange create individually controlled microclimate.



Air flow:
up to 50 m³/h
14 l/s



Heat recovery efficiency:
up to 92 %



Power: from 1.00 W
SFP: from 0.48 W/l/s



Noise level:
from 12 dBA



Design

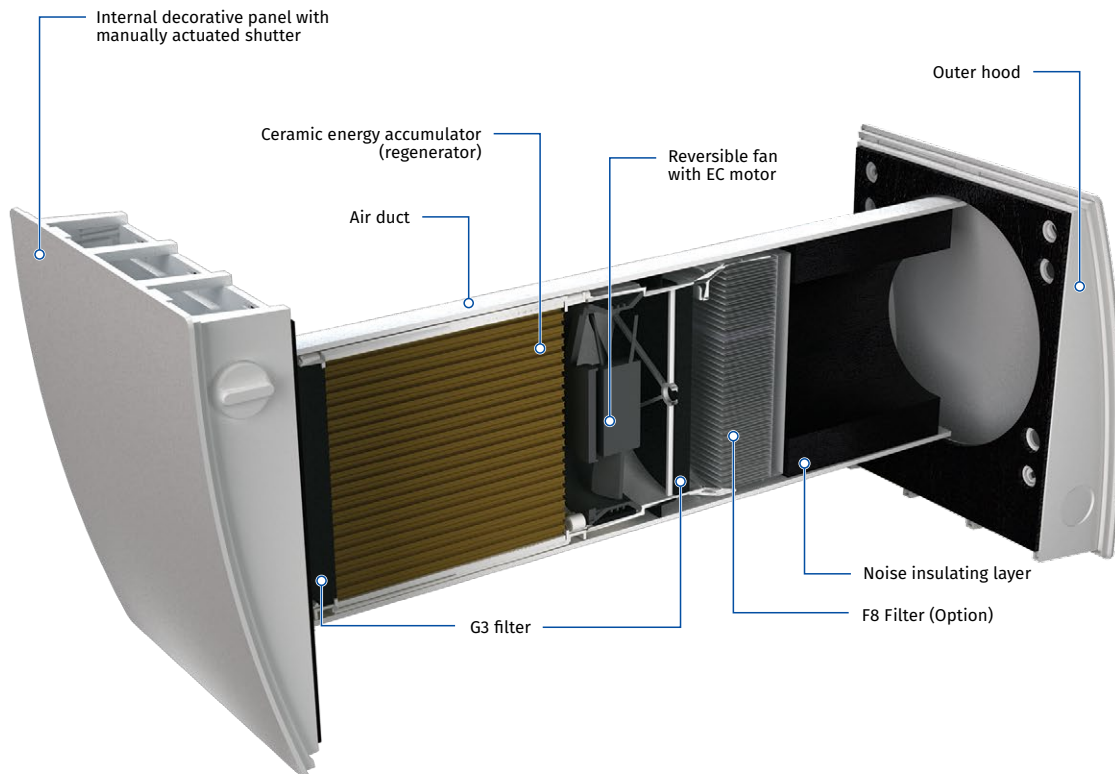

Designation key

Model	Air duct	Rated air flow [m ³ /h]	Internal grille type	Ventilation hood type	Control
Vento Eco	A: round air duct	50	-4	S11: plastic hood for standard walls S: metal hood for thin walls	Pro: sensor control panel

VENTO ECO A50-4 S11 PRO

HEAT RECOVERY SINGLE-ROOM UNITS

Heat and humidity regeneration

UNIT OPERATING LOGIC IN WINTER PERIOD

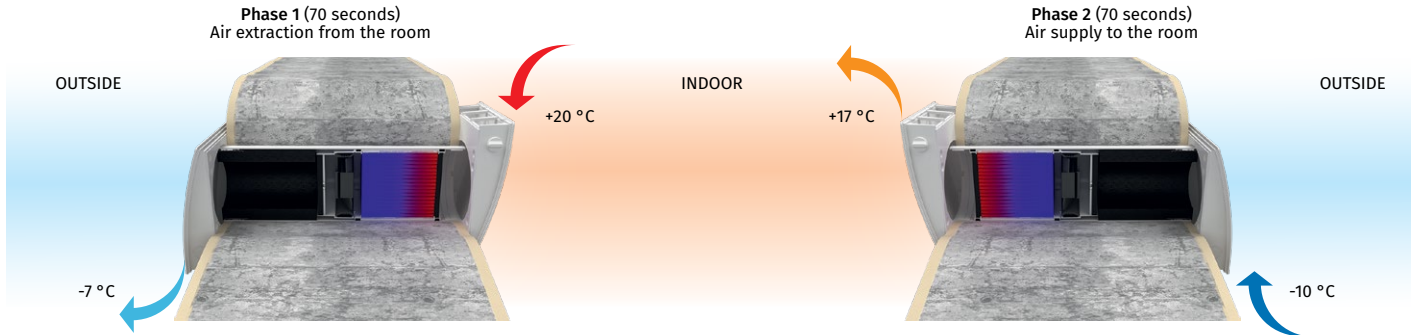

- Warm stale air is extracted from the premise, flows through the ceramic regenerator and transfers its heat energy and moisture to it.
- As the ceramic regenerator gets warmed up, the unit switches to the supply mode.
- Clean cold intake air flows through the regenerator and absorbs accumulated heat and humidity.
- When the ceramic regenerator is cooled down, the unit switches to the extract air mode.

Control

- Control of the unit operation mode is performed by means of the sensor control panel.

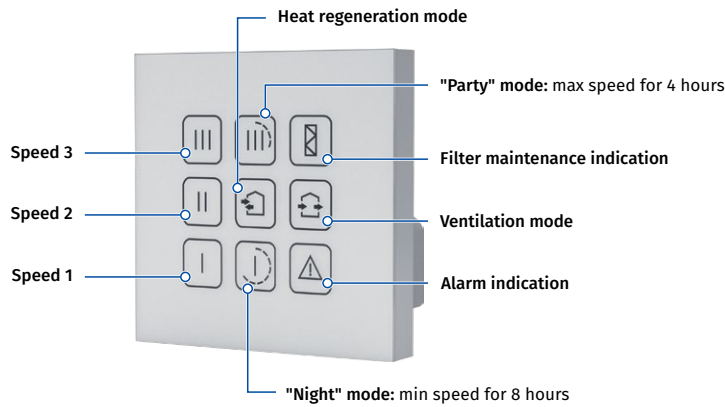

- One control panel with sensor buttons can control up to two units.
- Low voltage (12 V) power supply between control panel and **Vento Eco** units.

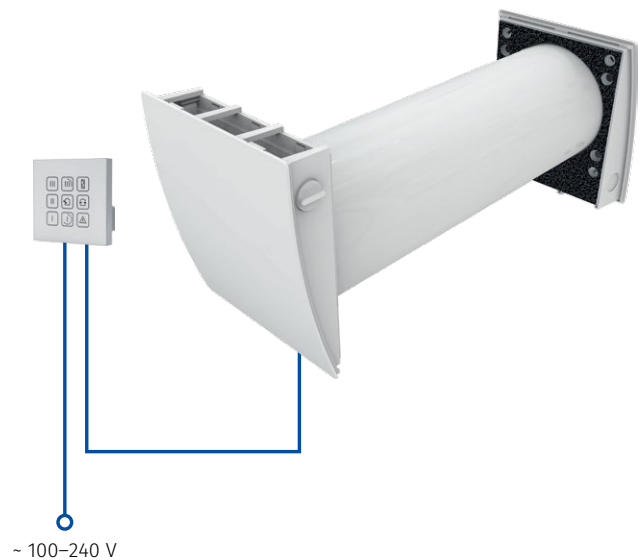

VENTO ECO A50-4 S11 PRO

HEAT RECOVERY SINGLE-ROOM UNITS

Mounting

- The unit is designed for through-the-wall installation inside a prepared hole in an outer wall of the building.
- One unit is able to ventilate a room up to 25 m². For bigger rooms two or more units must be installed.

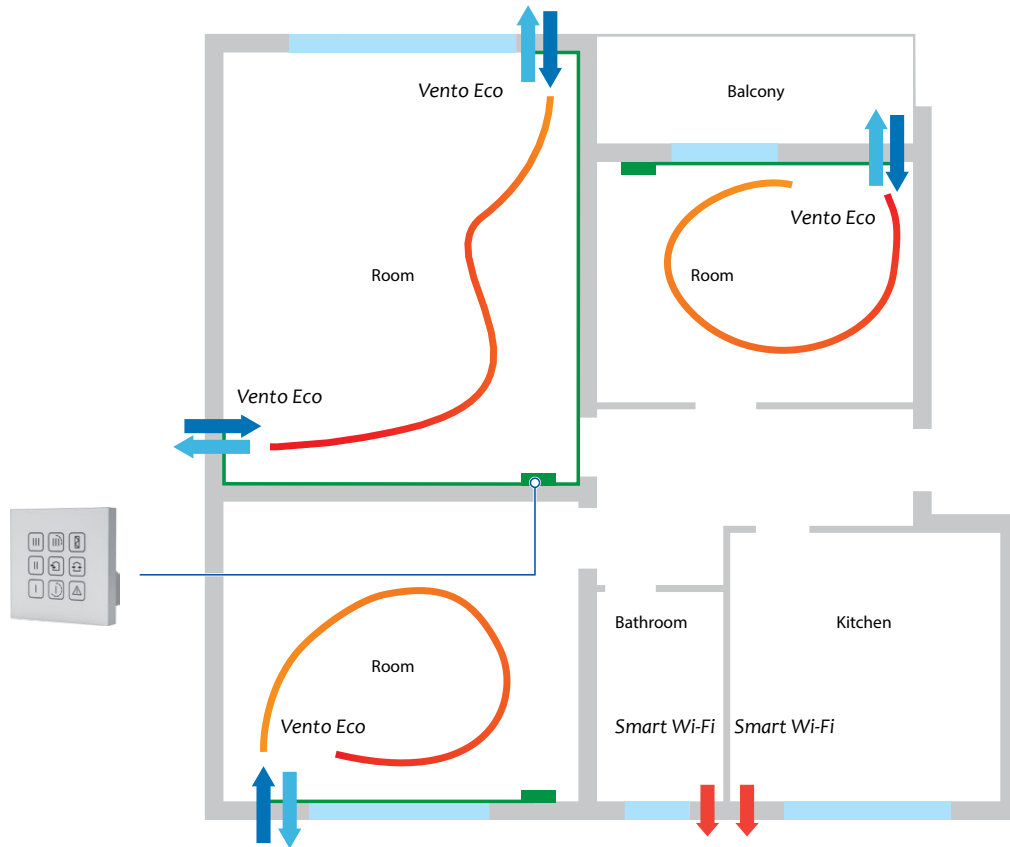

VENTO ECO A50-4 S11 PRO

HEAT RECOVERY SINGLE-ROOM UNITS

Technical data

Parameters	Vento Eco A50-4 S11 Pro Vento Eco A50-4 S Pro		
	I	II	III
Speed			
Voltage [V / 50 (60) Hz]	100-240		
Power [W]	1.00	2.10	4.30
Current [A]	0.017	0.025	0.041
RPM [min ⁻¹]	915	1555	2330
Air flow in ventilation mode [m ³ /h (l/s)]	15 (4)	30 (8)	50 (14)
Air flow in heat recovery mode [m ³ /h (l/s)]	8 (2)	15 (4)	25 (7)
SFP [W/l/s]	0.48	0.50	0.62
Filter	G3 (Option: F8 PM2.5 > 99%*)		
Transported air temperature [°C]	-20(-30**)...+40		
Heat recovery efficiency according to DIBt LÜ-A 20 [%]	up to 92		
Outdoor sound pressure attenuation according to DIN EN 20140 [dBA]	41		
Classification of air flow sensitivity to pressure difference variations in accordance with EN 13141-8	S3***		
Indoor/outdoor airtightness classification of the complete unit in accordance with EN 13141-8	D1		
Sound pressure level at 1 m according to ISO 3741: 2004 [dBA]	21	27	29
Sound pressure level at 3 m according to ISO 3741: 2004 [dBA]	12	18	20
Ingress protection rating	IP24		

* maximum air flow 40 m³/h

** with ZL1 Vento 160/100 cartridge and AH-8 outer hood applied

*** at III speed

ENERGIA - ЕНЕРГИЯ - ЕНЕРГІЯ - ENERGIJA - ENERGI - ENERIE - ENERGI

2020 1254/2014

Overall dimensions [mm]

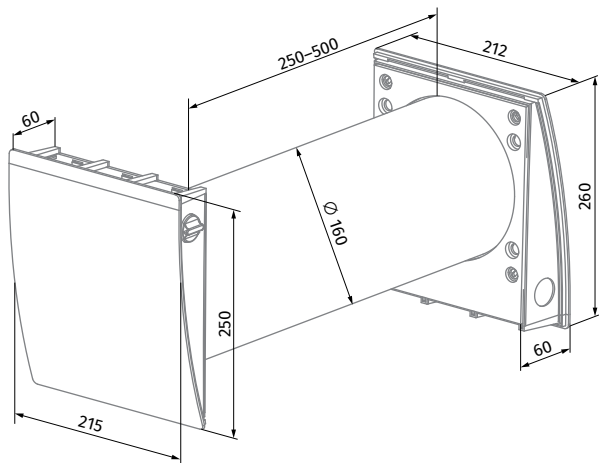

Vento Eco A50-4 S11 Pro

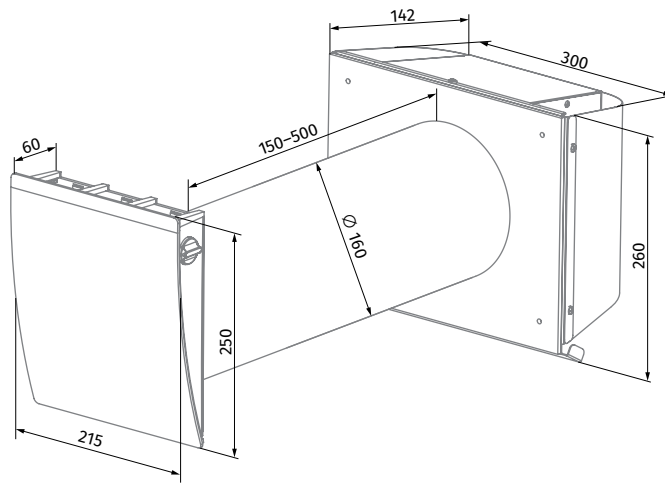









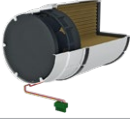















Vento Eco A50-4 S Pro
(for thin walls)

VENTO ECO A50-4 S11 PRO





HEAT RECOVERY SINGLE-ROOM UNITS

Accessories

Name		Description
Completion Kit Vento Eco A50-4		Indoor grille and cartridge with heat regenerator, fan and G3 filters
ZL1 Vento 160/150		Cartridge with heat regenerator for cold climate
FP2 Vento G3		G3 filters (2 pcs.)
FP2 Vento F8		G2 + F8 filters (1 pc.). Filtration rate PM2.5 > 99 %. Combination of G2 + F8 filters reduces air flow down to 40 m³/h
AH-8 white 160		White painted aluminium outer ventilation hood with frost protection for a cold climate
AH-8 chrome 160		Brushed stainless steel outer ventilation hood with frost protection for a cold climate
AH-10 *colour* 160		Plastic outer ventilation hood. Available in colours:  white  black  grey  terracotta  brown  vintage
AH-10 chrome 160		Plastic outer ventilation hood with a plate with brushed stainless steel effect finish
AH-11 *colour* 160		Plastic outer ventilation hood. Available in colours:  white  black  grey  terracotta  brown  vintage
AH-S chrome 160		Outer ventilation hood for thin wall made of brushed stainless steel
AH-S white 160		Outer ventilation hood for thin wall made of stainless steel, painted white
PP 160/0,5		Outer ventilation hood for mounting from inside
KIT BlauPlast white 160		Kit for angular mounting with white colour grille (for walls with standard thickness)

VENTO ECO A50-4 S11 PRO

HEAT RECOVERY SINGLE-ROOM UNITS

Name		Description
KIT BlauPlast chrome 160		Kit for angular mounting with stainless steel outer grille (for walls with standard thickness)
R 160-500		500 mm air duct and plastic foam plug
R 160-700		700 mm air duct and plastic foam plug
SE Vento Eco A50 Pro		Sensor control panel