

VENTO ECO A30-4 S11 PRO

HEAT RECOVERY SINGLE-ROOM UNITS

Features

- Arrangement of efficient energy-saving supply and exhaust single-room ventilation in flats, houses, cottages, social and commercial premises.
- Protection from outdoor noise.
- Reducing heat losses caused by ventilation due to heat recovery.
- Humidity balance and regulated air exchange create individually controlled microclimate.



Air flow:
up to 30 m³/h
8 l/s



Heat recovery efficiency:
up to 81 %



Power: from 1.03 W
SFP: from 0.71 W/l/s



Noise level:
from 21 dBA



Design

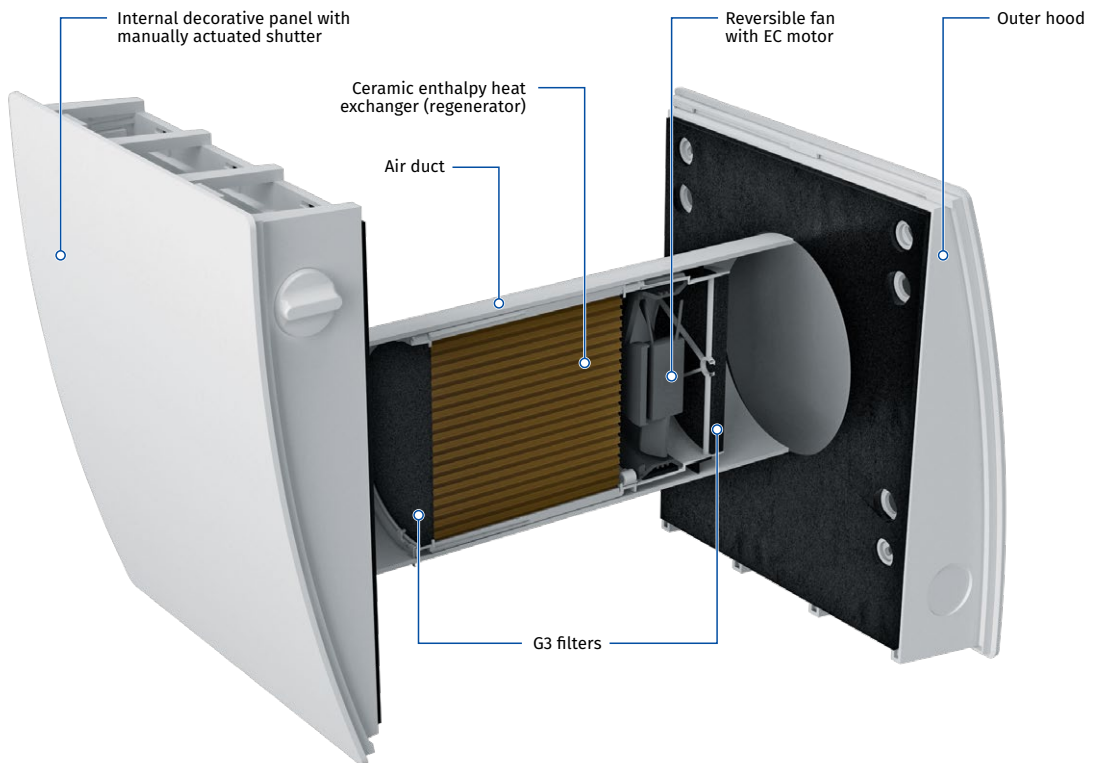

One of the best regeneration efficiency on the market due to innovative hexagonal structure of the heat exchanger cells

Designation key

Model	Air duct	Rated air flow [m ³ /h]	Internal grille type	Ventilation hood type	Control
Vento Eco	A: round air duct	30	4	S11: plastic hood for standard walls S: metal hood for thin walls	Pro: sensor control panel

VENTO ECO A30-4 S11 PRO

HEAT RECOVERY SINGLE-ROOM UNITS

Heat and humidity regeneration

UNIT OPERATING LOGIC IN WINTER PERIOD

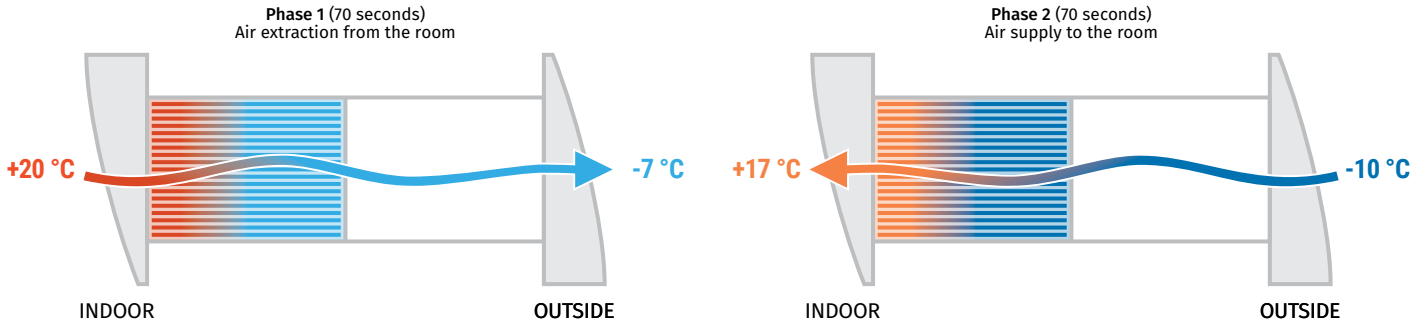

- Warm stale air is extracted from the premise, flows through the ceramic regenerator and transfers its heat energy and moisture to it.
- As the ceramic regenerator gets warmed up, the unit switches to the supply mode.
- Clean cold intake air flows through the regenerator and absorbs accumulated heat and humidity.
- When the ceramic regenerator is cooled down, the unit switches to the extract air mode.

Control

- Control of the unit operation mode is performed by means of the sensor control panel.

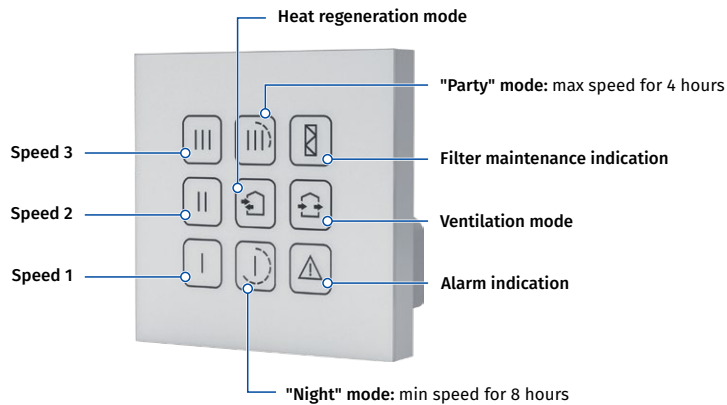

- One control panel with sensor buttons can control up to two units.
- Low voltage (12 V) power supply between control panel and **Vento Eco** units.

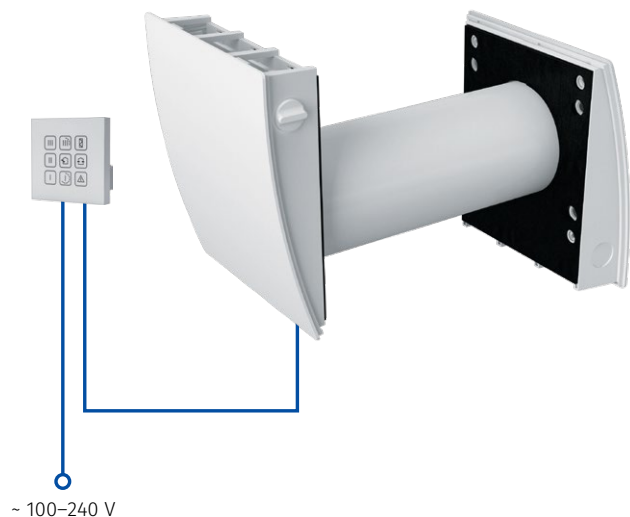

VENTO ECO A30-4 S11 PRO

HEAT RECOVERY SINGLE-ROOM UNITS

Mounting

- The unit is designed for through-the-wall installation inside a prepared hole in an outer wall of the building.
- One unit is able to ventilate a room up to 15 m². For bigger rooms two or more units must be installed.
- The best ventilation solution is pairwise installation of reverse phase synchronized units. One unit ensures supply of fresh air to the room and the other one extracts air from the premise. This way the most efficient balanced ventilation is arranged.

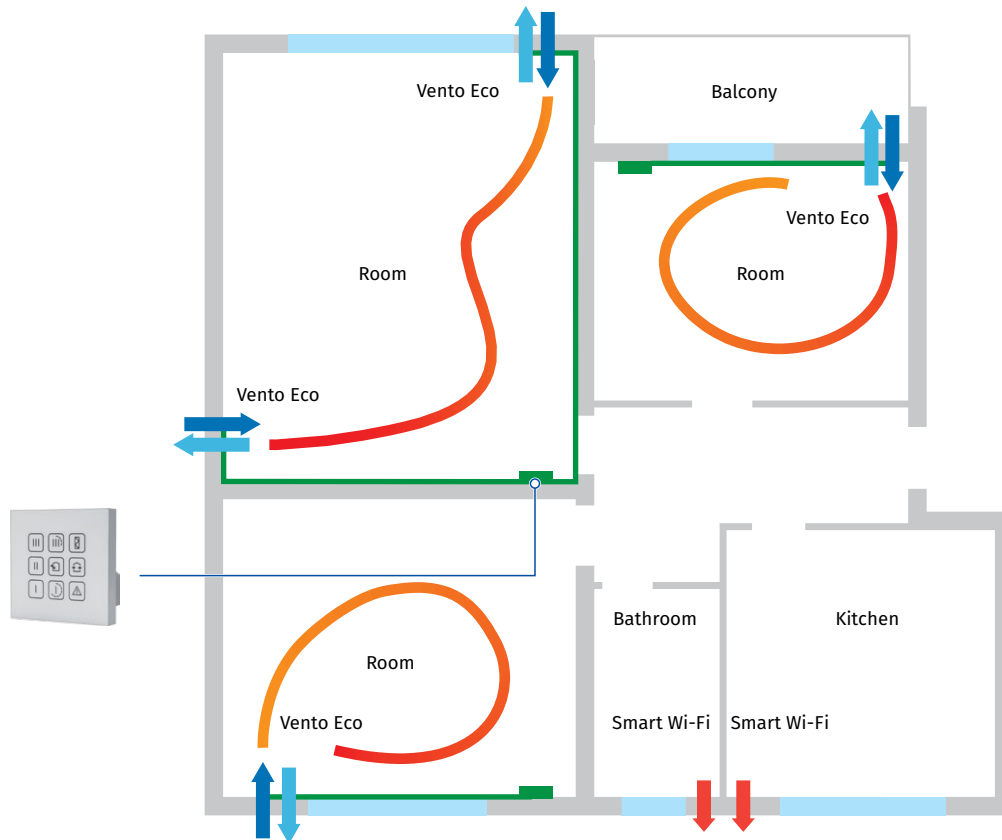

VENTO ECO A30-4 S11 PRO

HEAT RECOVERY SINGLE-ROOM UNITS

Technical data

Parameters	Vento Eco A30-4 S11 Pro Vento Eco A30-4 S Pro		
	I	II	III
Speed			
Voltage [V / 50 (60) Hz]		100-240	
Power [W]	1.03	1.96	3.47
Current [A]	0.021	0.027	0.038
RPM [min ⁻¹]	1600	2200	2500
Air flow in ventilation mode [m ³ /h (l/s)]	10 (3)	20 (6)	30 (8)
Air flow in heat recovery mode [m ³ /h (l/s)]	5 (1)	10 (3)	15 (4)
SFP [W/l/s]	0.74	0.71	0.83
Transported air temperature [°C]		-20...+40	
Heat recovery efficiency [%]		up to 81	
Outdoor sound pressure attenuation according to DIN EN 20140 [dBA]		42	
Indoor/outdoor airtightness classification of the complete unit in accordance with EN 13141-8		D1	
Sound pressure level at 1 m according to ISO 3741: 2004 [dBA]	30	37	40
Sound pressure level at 3 m according to ISO 3741: 2004 [dBA]	21	28	31
Ingress protection rating		IP24	

ENERGIA - ЕНЕРГИЯ - ΕΝΕΡΓΕΙΑ - ENERGIA - ENERGY - ENERGIE - ENERGI

2020 1254/2014



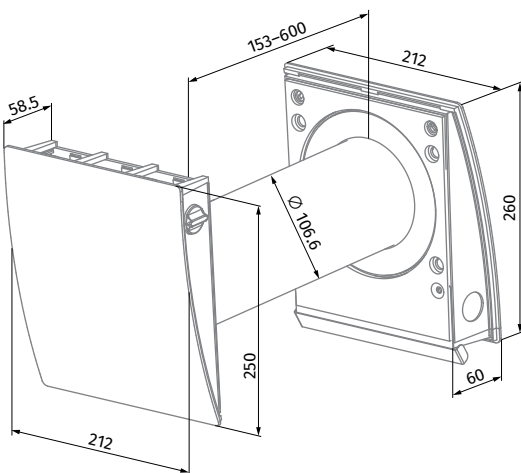







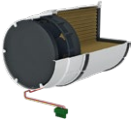

Overall dimensions [mm]



VENTO ECO A30-4 S11 PRO



HEAT RECOVERY SINGLE-ROOM UNITS

Accessories

Name		Description
Completion Kit Vento Eco A30-4		Indoor grille and cartridge with heat regenerator, fan and G3 filters
ZL1 Vento 100		Cartridge with heat regenerator for cold climate
FP2 Vento G3		G3 filters (2 pcs.)
AH-8 white 100		White painted aluminium outer ventilation hood with frost protection for a cold climate
AH-8 chrome 100		Brushed stainless steel outer ventilation hood with frost protection for a cold climate
AH-10 *colour* 100		Plastic outer ventilation hood. Available in colours: 
AH-10 chrome 100		Plastic outer ventilation hood with a plate with brushed stainless steel effect finish
AH-11 *colour* 100		Plastic outer ventilation hood. Available in colours: 
AH-S chrome 100		Outer ventilation hood for thin wall made of brushed stainless steel
AH-S white 100		Outer ventilation hood for thin wall made of stainless steel, painted white
KIT BlauPlast white 100		Kit for angular mounting with white colour grille (for walls with standard thickness)
KIT BlauPlast chrome 100		Kit for angular mounting with stainless steel outer grille (for walls with standard thickness)

VENTO ECO A30-4 S11 PRO

HEAT RECOVERY SINGLE-ROOM UNITS

Name		Description
BlauPlast RTR 100/0.35-0.5		Telescopic air duct with the diameter of 100 mm and adjustable length from 350 to 500 mm
BlauPlast RTR 100/0.5-1		Telescopic air duct with the diameter of 100 mm and adjustable length from 500 to 1000 mm
SE Vento Eco A30 Pro		Sensor control panel