

Valeo-BP

Mono-pipe ventilation exhaust centrifugal fans

Use

- Exhaust ventilation systems installed in high-rise buildings and premises.
- Mono-pipe ventilation systems.
- For mounting in kitchens and bathrooms.
- Flush wall or ceiling mounting.



Air flow:
up to 100 m³/h
28 l/s



Power:
from 15 W



Noise level:
from 27 dBA



Design

- The fan consists of the plastic casing **BP** for flush mounting and exhaust ventilation unit **Valeo** with a flat front panel.
- The casing is made of durable ABS plastic and fitted with a gravity back-draft damper to prevent backdraft.



- The front panel is made of snow white UV-resistant plastic.
- G4 purifying durable filter protects the motor, impeller and ductwork system against soiling.
- The filter is easily accessible for service operations.
- Due to modern design and various colour modifications the front panel matches well with any interior.
- The casing is equipped with oblong slotted joints to facilitate mounting of the casing in true vertical position.
- If the casing is installed with some vertical deviations, the special turnable grille conceals possible mounting inaccuracies.
- Power is supplied to the fan through a sealed electric lead-in on the casing and the ventilation unit is equipped with an airtight terminal block for connection to the wiring system.
- For room-to-room ventilation some ventilation unit modifications are equipped with extra spigots: **Valeo-BPL** – on the left; **Valeo-BPR** – on the right; **Valeo-BPD** – on the bottom.
- Ingress protection rating IP55.

Motor

- Two-speed motor with a centrifugal impeller. Minimum energy demand.
- The impeller has forward curved blades.
- Automatic maintaining of constant air flow depending on variable air resistance of the duct.
- Balanced impeller ensures low noise operation.
- Best aerodynamic characteristics due to a special scroll casing design.
- Ball bearings provide long service life.
- The ventilation unit with the motor is fixed inside the casing with special latches.





Speed control

- Step speed control with an external speed controller, e.g. a **CDP-3/5** model which is available upon order.
- Wide range of intellectual controls programmable by set parameters (timer, adjustable timer, internal switch, photo sensor, humidity sensor).

Designation key

Series	Air capacity according to speed	Option
Valeo-BP	35/60; 75/100	K: fire damper T: timer TR: regulated timer I: interval switch H: humidity sensor

Accessories

Filters	Speed controllers	Flexible ducts	Clamps
 FP-Valeo	 CDP	 BlauFlex AN	 K

Options

o Timer (Valeo-BP...T)

Depending on wiring connection the fan is off or runs permanently at low speed. The fan is turned to higher speed with an external switch 50 s after activation. After turning the switch off the fan continues operating within 6 min at higher speed and then reverts to default operation mode.

o Adjustable timer (Valeo-BP...TR)

Depending on wiring connection the fan is off or runs permanently at low speed. If the fan is turned on with an external switch, it switches to higher speed 0 to 150 s after switch activation. After turning the fan off it continues running at higher speed within 2 to 30 minutes and then reverts to the previous mode. The fan run-out time and delay time for higher speed are regulated with the internal regulator.

o Interval switch (Valeo-BP...I)

Depending on wiring connection the fan is off or runs permanently at low speed. In interval mode regulated from 0.5 to 15 hours the fan switches periodically to higher speed for 10 minutes. The switch interval is adjusted with the internal regulator. If the light in the room is turned with the external switch, the fan switches to higher speed in 50 s. After light is off the fan reverts to the interval mode operation.

o Humidity sensor (Valeo-BP...H)

Depending on wiring connection the fan is off or runs permanently at low speed. The fan switches to higher speed as relative humidity in the room increases from 60 % up to 90 % and switches off as humidity drops by 10 % below the set level. If the light in the room is turned on, the fan switches to higher speed in 50 s. The run-out time is set by the internal regulator from 2 to 30 minutes.

Mounting

- o Installed in a wall or ceiling during general construction works by mounting brackets supplied as a standard.
- o Connection to the main ventilation shaft with flexible air ducts.
- o For exhaust ventilation of a neighbour room remove a plug and install an additional spigot. Available upon separate order.
- o Exhaust spigot diameter 80 mm.
- o Power is supplied to the fan through a sealed electric lead-in on the casing.
- o After installation works cover the unit with a protecting cover to prevent dirt ingress.
- o After finishing works install the ventilation unit inside the casing and connect it to the wiring system.

Mounting example

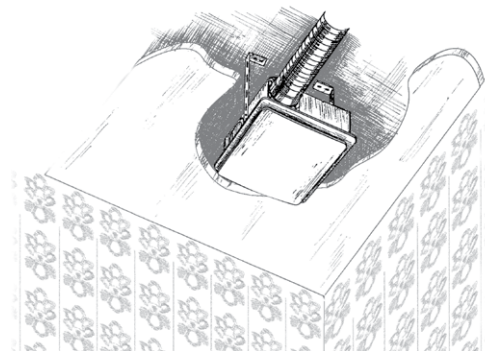

Overall dimensions [mm]

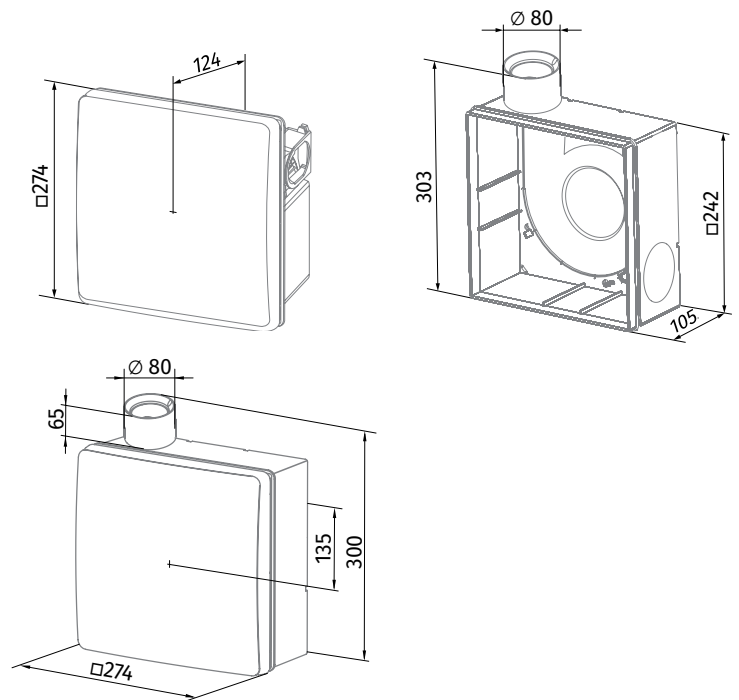

Technical data

Model	Valeo-BP 35/60	Valeo-BP 75/100
Speed	I / II	I / II
Voltage [V/Hz]	220-240/50	220-240/50
Power [W]	15 / 25	24 / 29
Current [A]	0.12 / 0.14	0.11 / 0.13
Cable cross section [mm ²]	3x1.5	3x1.5
Maximum air flow [m ³ /h (l/s)]	35 (10) / 63 (18)	75 (21) / 100 (28)
Sound pressure level [dBA]*	27 / 36	29 / 38
Max. transported air temperature [°C]	+50	+50
IP rating	IP55	IP55

* Sound pressure level measured in free space at a distance of 3 meters from the fan.

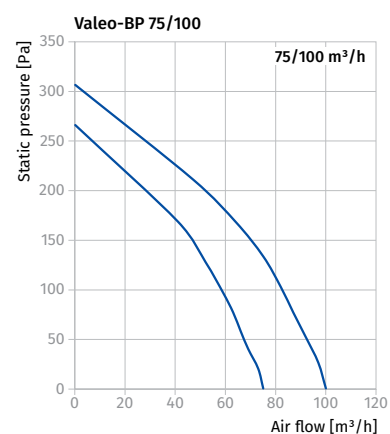
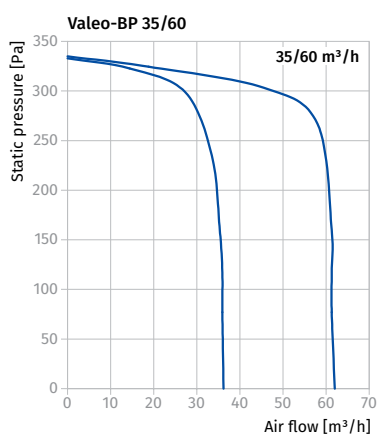

- The abrupt curves show high pressure performance and constant air flow of several **Valeo-BP** fans integrated into a single ventilation shaft.

High-rise mono-pipe ventilation system arrangement example

- The mechanical centralized mono-pipe exhaust ventilation system for kitchens and bathrooms based on Valeo-BP fans is specially designed for high-rise residential premises.
- Fresh air is supplied to bedrooms, children's room or living rooms through windows or wall vents. Vent modifications with air volume regulation are available.

- Stale air is extracted from the room by the extract fans through the inside doors or door grilles in the kitchen, bathroom or WC.
- This ventilation system arrangement ensures non-stop controllable air circulation in the room, comfortable microclimate and high fire safety.

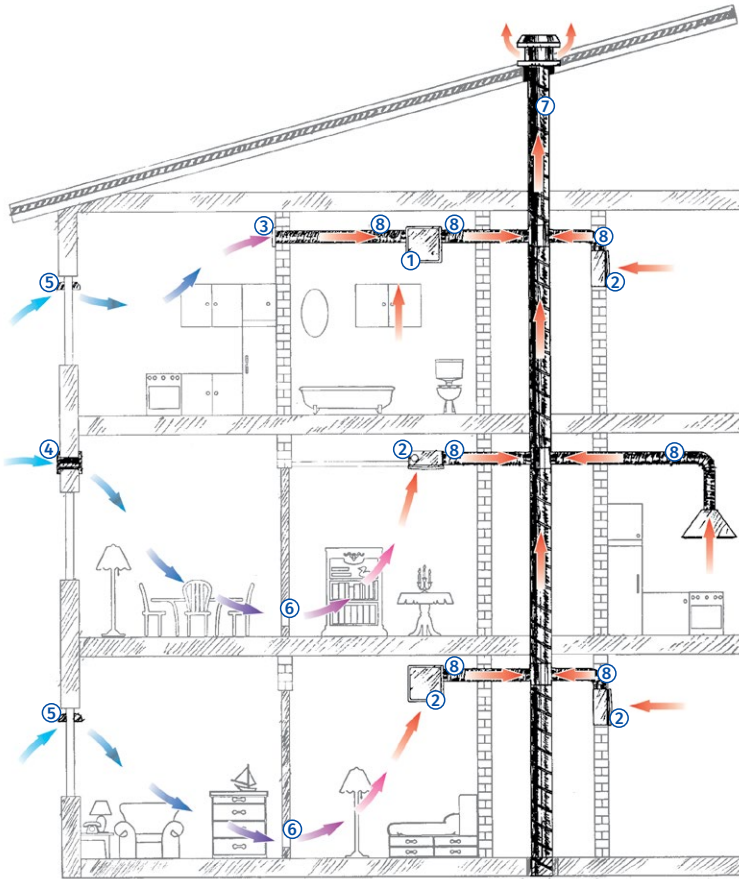

- 1 - Extract fan **Valeo-BPD** with an additional spigot for - room-to-room ventilation.
- 2 - Extract fan **Valeo-BP**.
- 3 - BLAUBERG wall grille, **DECOR** series.
- 4 - BLAUBERG wall vent, **WHM** series.
- 5 - BLAUBERG window vent, **FHM** series.
- 6 - BLAUBERG ventilation door grilles, **DECOR** series.
- 7 - Central ventilation shaft.
- 8 - Flexible air ducts for connection of extract fans to the central ventilation shaft, e.g. BLAUBERG air ducts, **BlauFlex** series.