



CENTRIFUGAL EXTRACT FAN



EN

Valeo

USER'S MANUAL

CONTENTS

Purpose.....	2
Brief description	8
Delivery set.....	8
Designation key.....	9
Operation guidelines	11
Mounting and set-up.....	16
Connection to power mains	28
Electronics operation algorithm	31
Timer and humidity sensor adjustment.....	32
Technical maintenance	34
Troubleshooting.....	36
Storage and transportation regulations.....	36
Manufacturer's warranty	37

PURPOSE

This user's manual is a main operating document intended for technical, maintenance, and operating staff.

The manual contains information about purpose, technical details, operating principle, design, and installation of the Valeo unit and all its modifications.

Technical and maintenance staff must have theoretical and practical training in the field of ventilation systems and should be able to work in accordance with workplace safety rules as well as construction norms and standards applicable in the territory of the country.



**READ THE USER'S MANUAL CAREFULLY BEFORE PROCEEDING WITH INSTALLATION WORKS.
COMPLIANCE WITH THE MANUAL REQUIREMENTS ENSURES RELIABLE OPERATION AND LONG
SERVICE LIFE OF THE UNIT. KEEP THE USER'S MANUAL AVAILABLE AS LONG AS YOU USE THE UNIT.
YOU MAY NEED TO REREAD THE INFORMATION ON THE PRODUCT SERVICING.**

This unit is not intended for use by persons (including children) with reduced physical, sensory or mental capabilities, or lack of experience and knowledge, unless they have been given supervision or instruction concerning use of the unit by a person responsible for their safety.

Children should be supervised to ensure that they do not play with the unit.

This appliance can be used by children aged from 8 years and above and persons with reduced physical, sensory or mental capabilities or lack of experience and knowledge if they have been given supervision or instruction concerning use of the appliance in a safe way and understand the hazards involved.

Cleaning and user maintenance shall not be done by children without supervision.

Children shall not play with the appliance.

Connection to the mains must be made through a disconnecting device, which is integrated into the fixed wiring system in accordance with the wiring rules for design of electrical units, and has a contact separation in all poles that allows for full disconnection under overvoltage category III conditions.

If the supply cord is damaged, it must be replaced by the manufacturer, its service agent, or similarly qualified persons in order to avoid a safety hazard.

Do not attach the product to the support using glue or adhesives. Use only the fastening method specified in the "User's manual".

Ensure that the unit is switched off from the supply mains before removing the guard.

Precautions should be taken to avoid backflow of gases into the room from open chimneys or appliances burning fuel.

All operations described in this manual must be performed by qualified personnel only, properly trained and qualified to install, make electrical connections and maintain ventilation units.

Do not attempt to install the product, connect it to the mains, or perform maintenance yourself.

This is unsafe and impossible without special knowledge.

Disconnect the power supply prior to any operations with the unit.

All user's manual requirements as well as the provisions of all the applicable local and national construction, electrical, and technical norms and standards must be observed when installing and operating the unit.

Disconnect the unit from the power supply prior to any connection, servicing, maintenance, and repair operations.

Connection of the unit to power mains is allowed by a qualified electrician with a work permit for the electric units up to 1000 V after careful reading of the present user's manual.

Check the unit for any visible damage of the impeller, the casing, and the grille before starting installation. The casing internals must be free of any foreign objects that can damage the impeller blades.

While mounting the unit, avoid compression of the casing!

Deformation of the casing may result in motor jam and excessive noise.

Misuse of the unit and any unauthorised modifications are not allowed.

Do not expose the unit to adverse atmospheric agents (rain, sun, etc.).

Transported air must not contain any dust or other solid impurities, sticky substances, or fibrous materials.

Do not use the unit in a hazardous or explosive environment containing spirits, gasoline, insecticides, etc.

Do not close or block the intake or extract vents in order to ensure the efficient air flow.

Do not sit on the unit and do not put objects on it.

The information in this user's manual was correct at the time of the document's preparation.

The Company reserves the right to modify the technical characteristics, design, or configuration of its products at any time in order to incorporate the latest technological developments.

Never touch the unit with wet or damp hands.

Never touch the unit when barefoot.

BEFORE INSTALLING ADDITIONAL EXTERNAL DEVICES, READ THE RELEVANT USER MANUALS.



**THE PRODUCT MUST BE DISPOSED SEPARATELY AT THE END OF ITS SERVICE LIFE.
DO NOT DISPOSE THE UNIT AS UNSORTED DOMESTIC WASTE.**

BRIEF DESCRIPTION

The product is a double-speed pressure fan for exhaust ventilation of small and medium-sized domestic spaces heated during the cold season. In the base models the fan speed is manually set by means of an external switch. The fan can be mounted to the ceiling or onto a wall with air extraction into a ventilation shaft or a round air duct of a matching diameter. Each specific fan model differs by mounting type:

— **Valeo-E** – wall mounting.

— **Valeo-BP, Valeo-BF** – concealed (wall flush mounting) mounting.

— **Valeo** — fan assembly designed for installation into a pre-installed **BP 80, BF 80**.

The **Valeo-BF, Valeo-BP K** meet special fire safety requirements and are designed for preventing smoke fume penetration into the serviced spaces through air ducts in the event of a fire.

DELIVERY SET

	Valeo-E	Valeo-BP Valeo-BF	Valeo	BP 80, BF 80
Fan assembly, pcs	1	1	-	-
Ventilation unit, pcs	-	-	1	-
Casing, pcs	-	-	-	1
Fastener set, pcs	1	1	1	1
Mounting bracket, pcs	-	2	-	2
Cardboard spacer, pcs	-	-	-	1
Plastic screwdriver, pcs (models with timer only)	1	1	1	-
Set of noise-insulated inserts	1	1	-	-
User's manual, pcs	1	1	1	1
Packing box, pcs	1	1	1	1

DESIGNATION KEY

Valeo - BPL Hi-Tech 35/60 K T

Additional options

T – timer
TR – user-adjustable timer
I – intermittent operation switch
H – humidity sensor (2nd speed)
H1 – humidity sensor (1st speed)

Fire-safety damper: (for Valeo-E, Valeo-BP)

_ - without fire-safety damper by default
K - fire-safety damper with fire resistance class EI90

Air flow (m³/h) according to the speed

35/60, 35/100, 35/60/100, 60/100, 75/100

Decorative panel

_ – white plastic
Hi-Tech – natural aluminum

Connection of air ducts from another room:

_ – not available
R – right-hand side
L – left-hand side
D – bottom side

Casing type

_ – no casing
E – surface-mounted housing
BP – plastic casing
BF – fire-proof casing with a fire resistance rating of E90/I60

Fan series

Conventional designation of casings for **Valeo** fans

BFDK 80

Fan series

80 – for series fan Valeo

Fire-safety damper: (for BE, BP)

_ – not available

K – fire-safety damper with fire resistance class EI90

Connection of air ducts from another room:

_ – not available

L – left-hand side

R – right-hand side

D – bottom side

Casing type

BP – plastic casing

BF – fire-proof casing with a fire resistance rating of E90/I60

OPERATION GUIDELINES

The fan is rated for connection to single-phase AC 220...240 V / 50 Hz power mains.
Ingress protection rating against access to hazardous parts and water ingress is IP55.
The fan is rated for operation at ambient temperatures ranging from +1°C to +40 °C.
The unit is rated as a Class II electrical appliance.

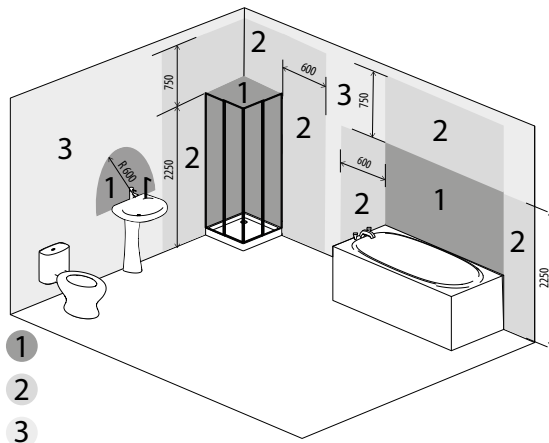

The unit with a protection rating against access to hazardous parts and water ingress IP55 is allowed to be installed in zone 2 according to the IEC 60364-7-701:2019.

Overall and connecting dimensions, the appearance of the products are shown in fig. 1-8.

Valeo-E

1

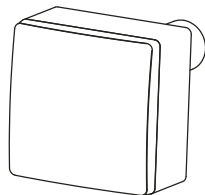
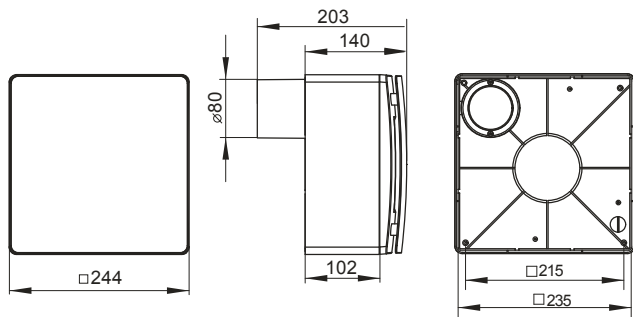

Valeo-EK

2

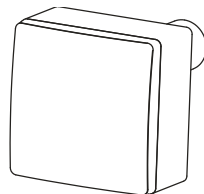
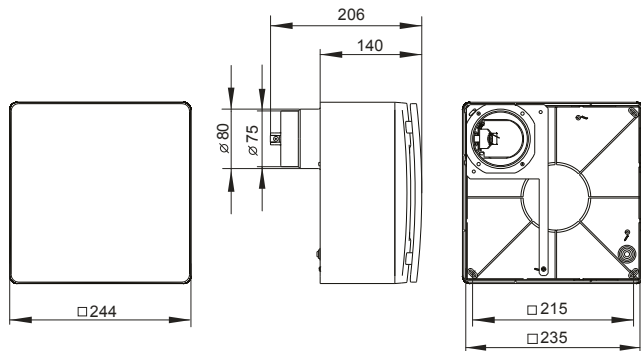

Valeo-BP

3

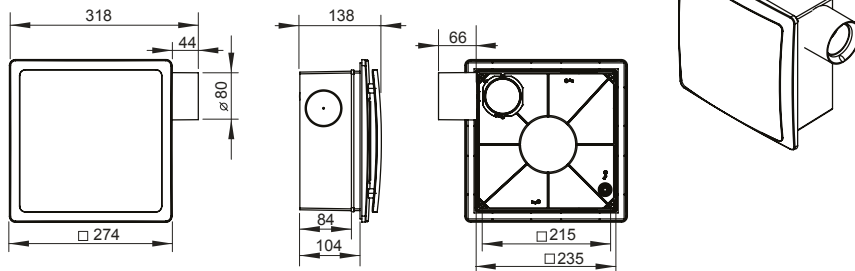

Valeo-BF

4

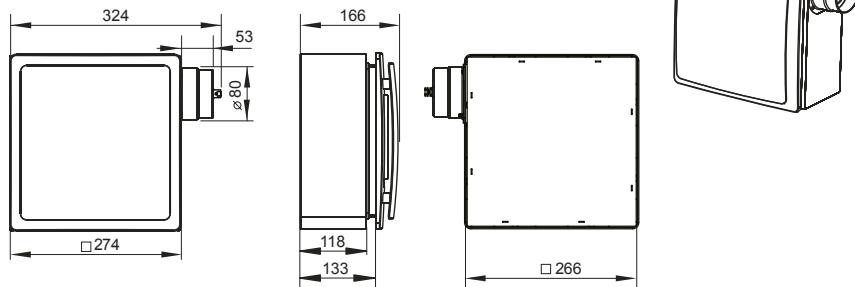

Valeo-BP K

5

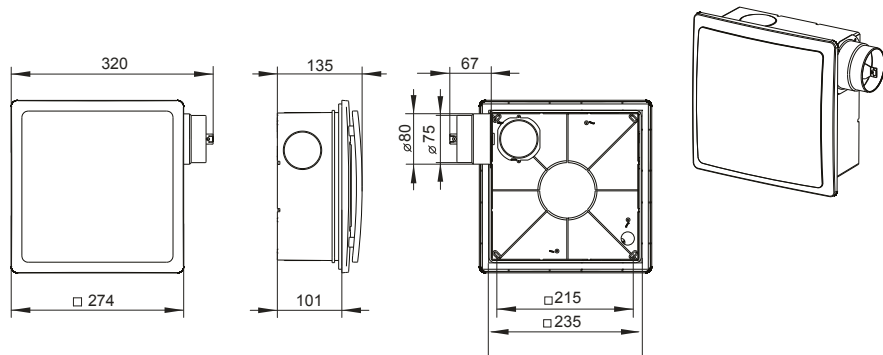

Valeo

6

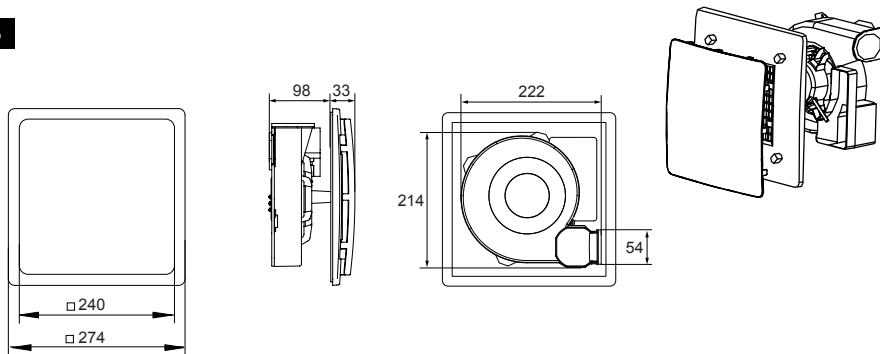

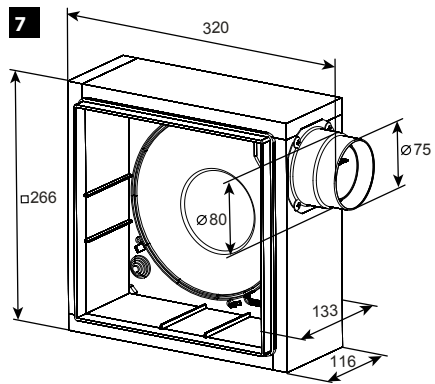
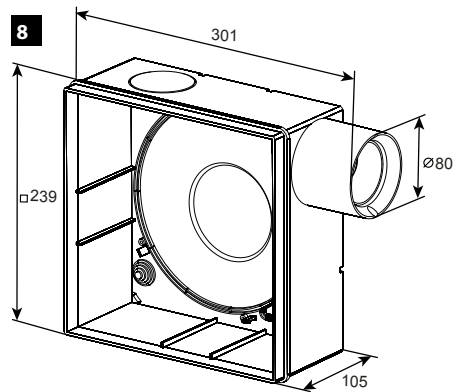
BF 80**BP 80**

MOUNTING AND SET-UP

The fan can be mounted to the ceiling or onto a wall with air extraction into a ventilation shaft or a round air duct of a matching diameter. The fan mounting example is shown in Fig. 9-19.

through-the-wall installation of fans with an additional inlet pipe is shown on Fig. 20-21.

Valeo-E fan installation steps:

- 1.1. Mark and drill a hole for the fan outlet spigot according to one of the 4 possible placement variants (Fig. 22-25).
- 1.2. Take off the front panel (Fig. 26).
- 1.3. Remove the filter (Fig. 27).
- 1.4. Undo the screw and take off the grille (Fig. 28). Remove the noise-absorbing inserts (Fig. 29).
- 1.5. Install the fan casing accordingly (Fig. 22-25), mark the holes for fastening with screws (Fig. 30).
- 1.6. Drill the dowel holes and insert the dowels.
- 1.7. Mount the fan casing together with the scroll and secure it to the mounting surface with self-tapping screws (Fig. 31).
- 1.8. Complete steps 1.2 to 1.4. in the reverse order.

Valeo-E K fan installation steps:

- 2.1. Mark and drill a hole for the fan outlet spigot according to one of the 4 possible placement variants (Fig. 22-24).
- 2.2. Complete steps 1.2. and 1.4.
- 2.3. Set the fire-safety swing damper to the mounting position (Fig. 32).
- 2.4. Mark the dowel holes (Fig. 33).
- 2.5. Drill the dowel holes and insert the dowels (Fig. 34).
- 2.6. Secure the fire-safety swing damper with self-tapping screws (Fig. 35).
- 2.7. Rotate the fan to match the mounting hole of the casing with that of the swing damper, and mark the dowel holes (Fig. 36).
- 2.8. Rotate the fan to access the markings, drill the dowel holes and insert the dowels (Fig. 37).
- 2.9. Rotate the fan and align the mounting holes of the casing and those of the swing damper, and secure the fan with self-tapping screws (Fig. 38).
- 3.10. Complete steps 1.2 to 1.4. in the reverse order.

Valeo-BP, Valeo-BF fans consist of **Valeo** fan assembly and **BP 80, BF 80** fan casings correspondingly.

These fans are installed in two phases: first the casing installation and then the final installation:

- the casing is installed during the shell and core phase.
- the final installation, which is performed after the fit-out works, includes the installation of **Valeo** fan assembly into **BP 80, BF 80** casing.

To install the **BP 80** casing:

- 5.1. Complete steps 1.2. and 1.4. *
- 5.2. Remove the fan assembly from the casing (Fig. 39-40).*
- 5.3. Bend the mounting bracket to the necessary length according to the actual wall measurements and secure it to the fan casing with M4 screws supplied with the unit (Fig. 41-44).
- 5.4. Route the power cable into the fan casing.
- 5.5. Fill the gaps between the fan casing and the wall opening with mortar, sealing foam etc.
- 5.6. Once the installation has been completed, cover the casing with the cardboard spacer to prevent damage or contamination during the fit-out works in the space (Fig. 45).

To install the **BF 80** casing:

- 4.1. Complete steps 3.1. and 3.2. *
 - 4.2. Make a recess in the shaft wall for the fan casing (Fig. 18).
 - 4.3. Connect an air duct to the fan outlet.
 - 4.4. Before installing the casing, make sure that the fire retardant spring-loaded non-return valve of the **BF 80** casing, which will be installed in the niche, closes in the absence of air flow under the influence of the spring.
 - 4.5. Install the **BF 80** casing into the recess and fix it with mortar.
- Route the power cable through the gland in the rear side of the casing, the minimum cable length from the housing should be at least 250 mm. The casing can also be mounted on a wall or ceiling using mounting brackets (Fig. 19).
- 4.6. Once the installation has been completed, cover the casing with the cardboard spacer to prevent damage or contamination during the fit-out works in the space (Fig. 45).

*If you purchased the casing separately and the fan assembly separately, you do not need to complete these steps.

To perform the final installation of **Valeo-BP, Valeo-BF** fans, it is necessary to do the following:

5.1 On completing the fit-out works in the space remove the cardboard spacer and install the **Valeo-BP, Valeo-BF** fan assembly (Fig. 47-48). The mountings allow fine adjustments of the grille angle relative to the fan casing for a level fit even if the casing is misaligned (Fig. 49).

If the **BP 80, BF 80** housing and the **Valeo** fan assembly are supplied separately, it is not necessary to disassemble the fan during installation. In everything else, the sequence of installation is preserved.



Before proceeding with the fan installation check the position of backdraft damper 2 which must close under its own weight in the absence of air flow (Fig. 56). By default the position of the backdraft damper corresponds to the outlet spigot to the right and upwards. If the spigot is pointed to the left after the installation remove the backdraft damper from the spigot 1, turn the damper 180° and insert it into the spigot.

Location of the backdraft damper in case of ceiling mounting.

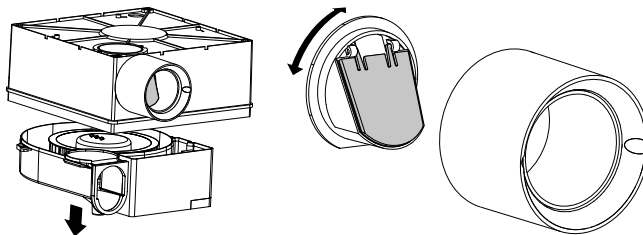

Use a steel pipe of rectangular cross-section or a spiral-wound air duct for the collective air duct.
Use flexible air ducts for the connection duct.
The nominal diameter of air duct connections is 80 mm.



If the connection air duct is concealed within a brick wall it should be wrapped with self-adhesive PVC tape to prevent mortar-induced corrosion.

Installation options Valeo-E

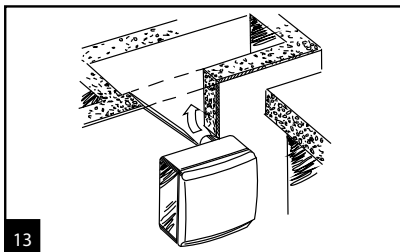
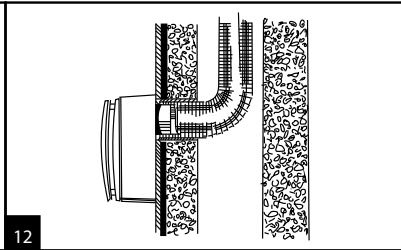
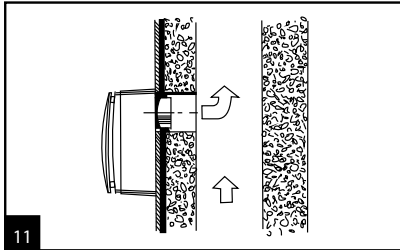
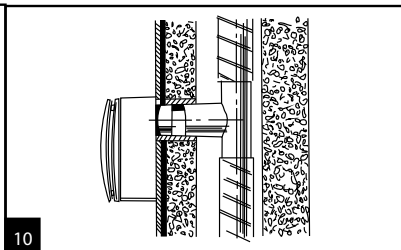
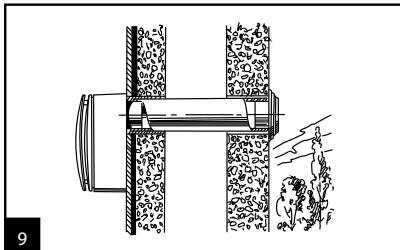

Installation options Valeo-BP

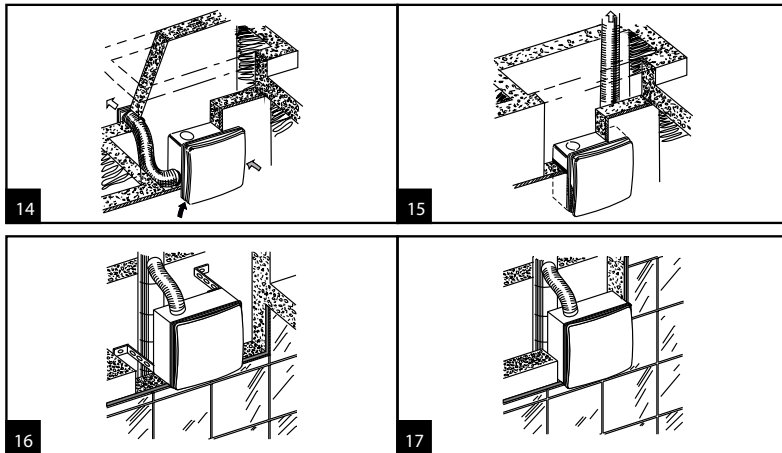

Installation options Valeo-BF

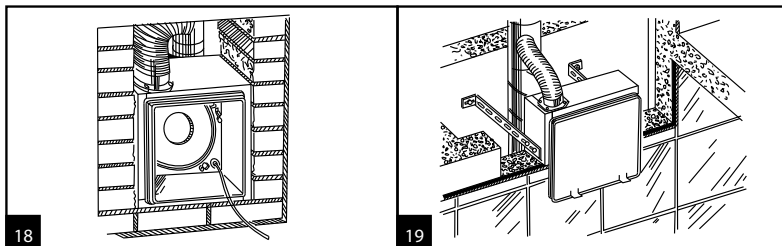

Installation options for fans with an additional inlet spigot

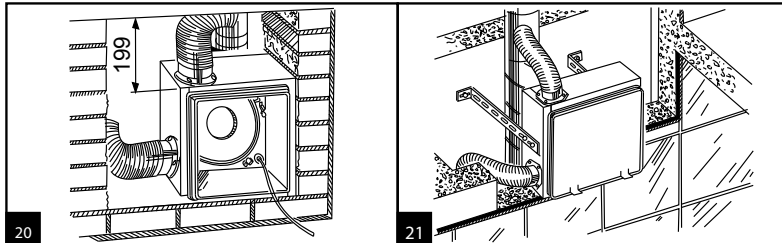

Fan placement options relative to walls and ceiling

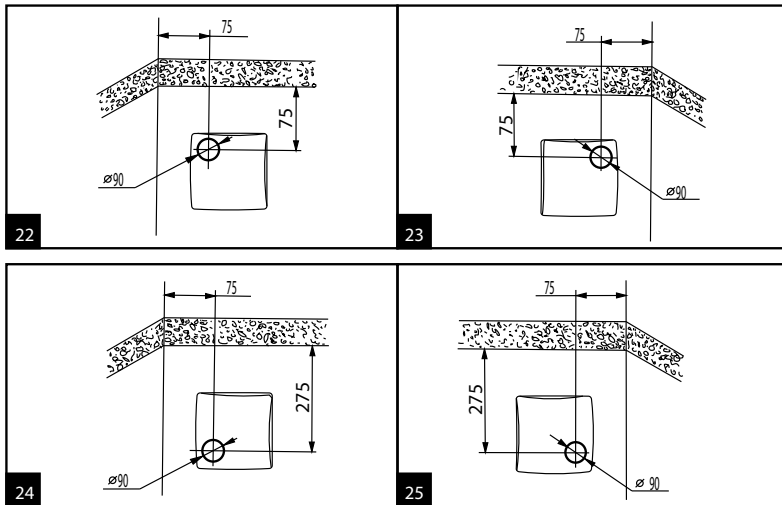

Installation steps Valeo-E

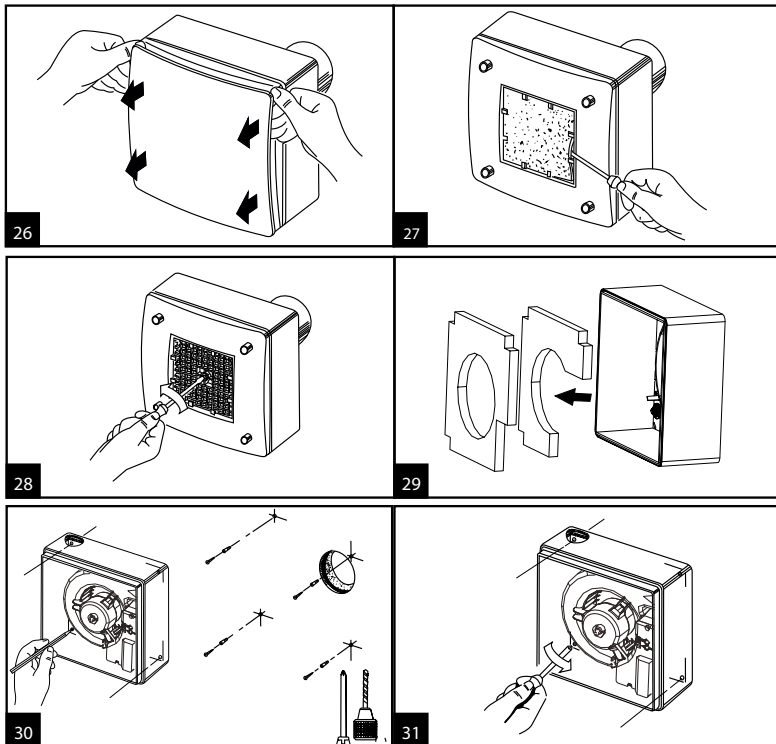

Installation steps Valeo-E K

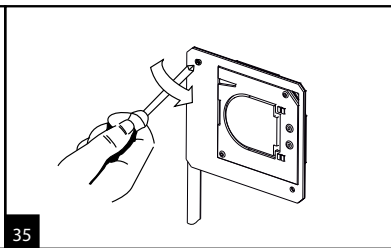
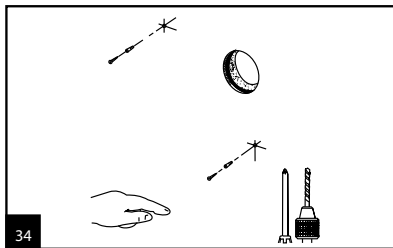
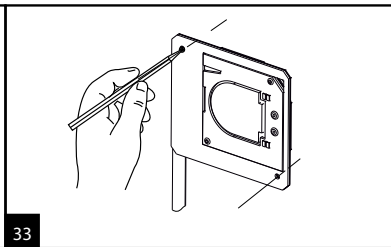
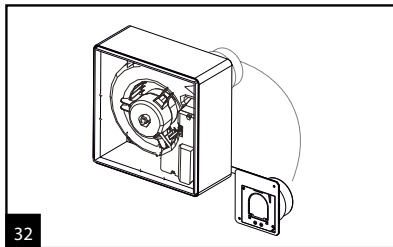

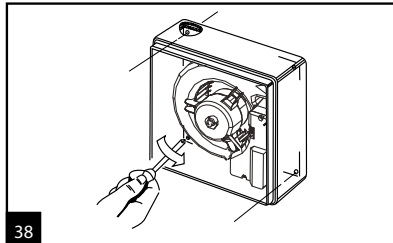
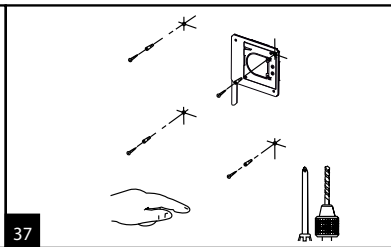
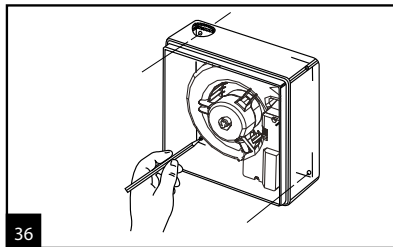

Installation steps Valeo-BP, Valeo-BF

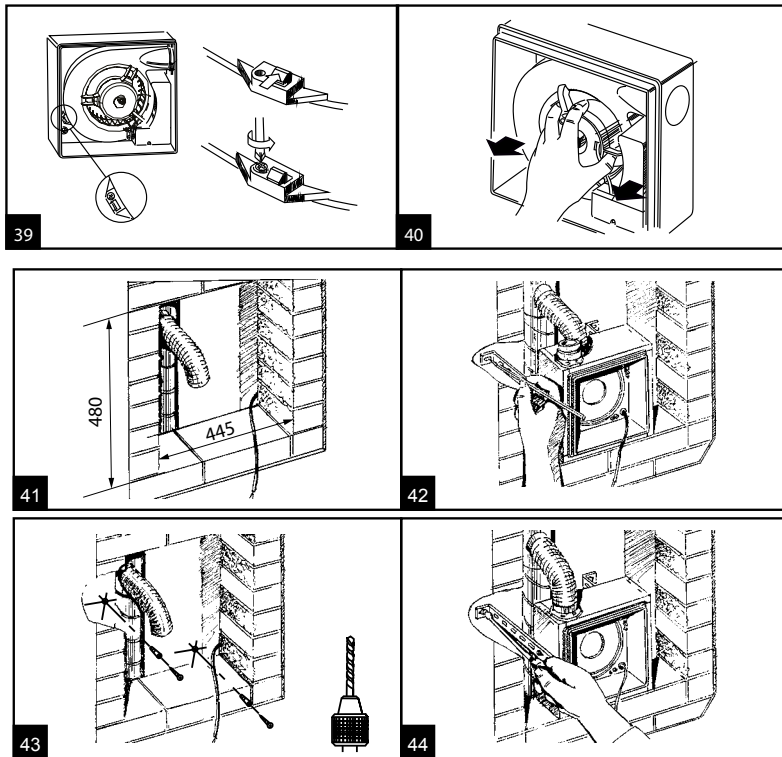

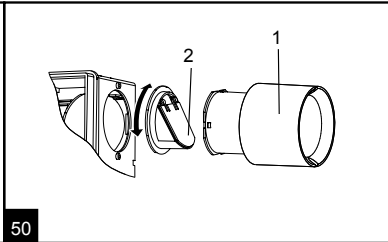
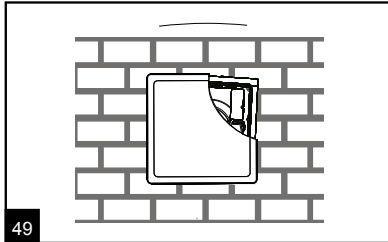
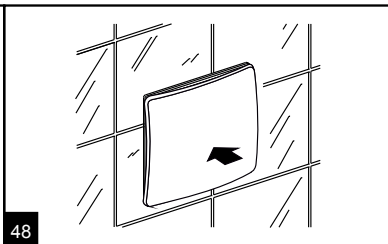
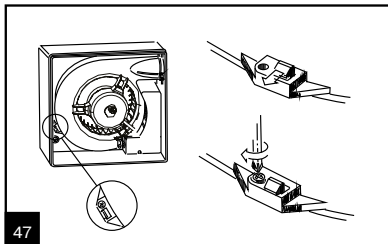
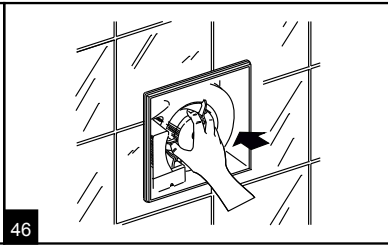
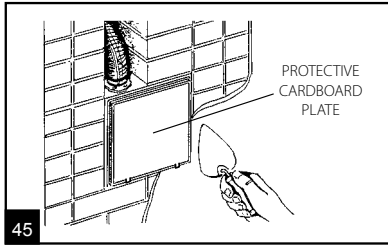

CONNECTION TO POWER MAINS

To connect the fan to the electric mains:

- Run the cable through the gland in the rear part of the casing (Fig. 51);
- Strip the insulation leaving 7–8 mm long tips;
- Remove the control unit cover (Fig. 51);
- Complete the electrical connections according to the external connections diagram (Fig. 52, 53);
- Clamp the wires with the retention clip (Fig. 51);
- Assemble the fan: re-install the lid, filter etc.;
- Apply supply voltage to the fan.

Connection of fans

Valeo ... 35/60

Valeo ... 35/100

Valeo ... 35/60/100

Valeo ... 60/100

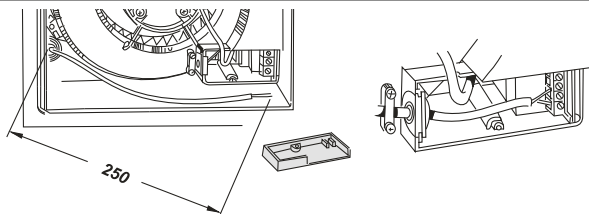

Valeo ... 75/100

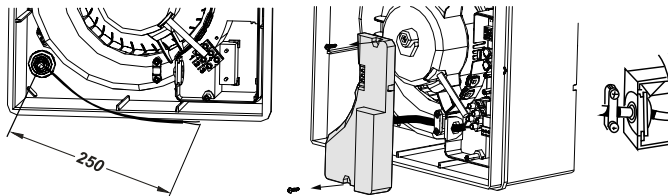

Wiring diagram of basic fan models

Valeo ... 35/60
Valeo ... 35/100
Valeo ... 60/100

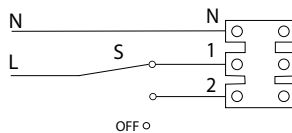

Valeo ... 35/60/100;

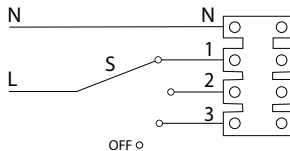

Valeo ... 75/100

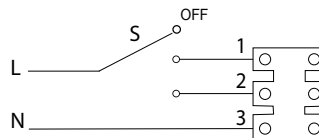

Designation key: L – phase N – neutral S – external switch

External switch S is used to set the fan to one of the available speeds or disable it manually.

Wiring diagram for fan models with timer, adjustable timer, interval switch or humidity sensor

Valeo ... 35/60; Valeo ... 35/100; Valeo ... 60/100

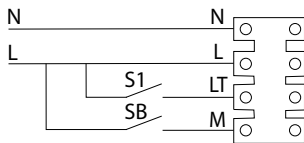

Valeo ... 75/100

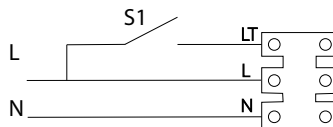

Designation key: L – phase N – neutral LT – line for switching the fan to maximum speed S, S1, SB – external switch

53

The fan operates at speed 1 when the SB switch is closed or switched off when it is open.

The timer circuit board of the **Valeo ... 75/100** contains a DIP switch which controls the initial state of the fan.



Mode 1

In the **OFF** — position the fan is initially disabled.

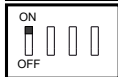

Mode 2

In the **ON** — position the fan initially runs at low speed.

ELECTRONICS OPERATION ALGORITHM

T — timer

The fan is switched on to the 2nd speed manually by an external switch S1 in parallel with the lighting, with a turn-off delay time of 50 seconds. Once the external switch S1 is returned to the initial position the fan shuts down after a 6 minute timer delay.

TR — user-adjustable timer

The fan is switched to the 2nd speed manually by the external switch S1 in parallel with the lighting.

The delay time is set within the 0-150 second range by means of the internal controller.

The timer run-down time after S1 switch disengagement is set within the 2-30 minute range by means of the internal controller.

I - with an interval switch

The fan runs with periodic activation of the 2nd speed.

The interval between switching on is set by the internal controller and ranges from 0.5 to 15 hours.

Each cycle lasts for 10 minutes. Can be activated manually with the external switch S1 simultaneously with the lights (with a 50-second activation delay). When the S1 switch is set to OFF, the fan reverts to the original state.

H — humidity sensor

The fan switches to Speed 2 when the relative humidity in the room reaches a certain level.

The humidity threshold can be adjusted in the 60 % to 90 % range. The fan shuts down when the relative humidity level drops 10 % below the pre-set threshold.

The fan is switched on to the 2nd speed by the external switch S1 in parallel with the lighting, while the turn-on delay is 50 seconds, and the turn-off delay time after switching off the S1 is set by the internal controller and is between 2 and 30 minutes.

H1 – with humidity sensor

The fan turns on at the 1st speed when the level of relative humidity in the room increases.

The humidity threshold is adjustable from 60% to 90%. Turns off when the set relative humidity drops by 10%.

The fan is turned on at the 2nd speed by the external switch S1 in parallel with the lighting, while the turn-on delay is 50 seconds, and the run-out time after turning off S1 is set by the internal regulator and is from 2 to 30 minutes.

TIMER AND HUMIDITY SENSOR ADJUSTMENT



DO NOT USE A METAL SCREWDRIVER, KNIFE, ETC. FOR ADJUSTMENT OPERATIONS NOT TO DAMAGE THE CIRCUIT BOARD

Attention! The control board circuit is live!

Disconnect the fan from power supply prior to any adjustment operations. The fan is supplied with a special plastic screwdriver for adjusting the settings. Used to change the timer setting or the relative humidity sensor threshold.

To adjust the timer delay, turn the knob of the potentiometer **T(T1)** clockwise to increase the timer delay or counterclockwise to decrease it (Fig. 54-56).

To adjust the humidity threshold, turn the knob of the potentiometer **H** counterclockwise to increase the threshold or clockwise to decrease it (Fig. 56).

Variant **TR** (Fig. 54):

T1 – turn-on delay time adjustment (from 0 to 150 seconds).

T – turn-off delay time adjustment after deactivation (from 2 to 30 minutes).

I variant (Fig. 55):

T — interval timer adjustment (from 30 minutes to 15 hours).

Variant **H(1)** (Fig. 56):

T – turn-off delay time adjustment after deactivation (from 2 to 30 minutes).

H – humidity sensor threshold adjustment (from 60 % to 90%).

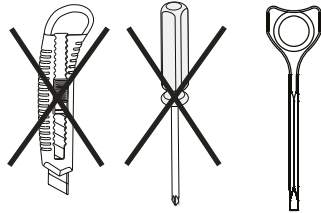
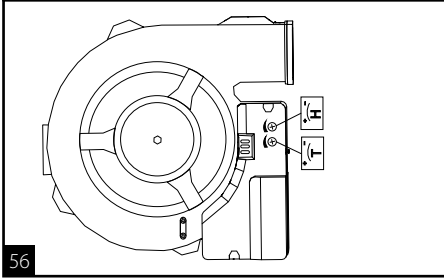
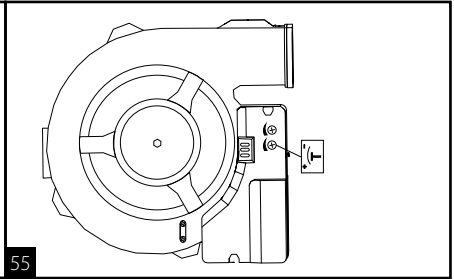
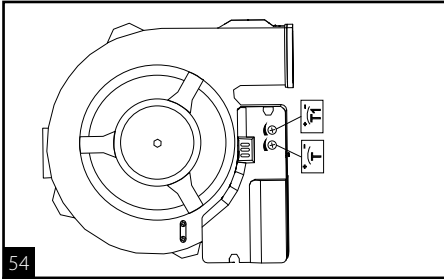

TECHNICAL MAINTENANANCE

Technical maintenance includes periodic filter replacement and cleaning the fan surfaces from dust and dirt.

The impeller blades require thorough cleaning every 6 months.

The filter must be replaced on a need-to-do basis, but at least every 6 months.

To replace the filter:

- Disconnect the fan from the electric mains (Fig. 57).
- Remove the filter by completing steps 1.2 and 1.3 or 2.2. to 2.4 in the «Installation and set-up» section.
- Replace the filter and re-assemble the fan in the reverse order.
- Connect the fan to power mains (Fig. 60).

To clean the fan surface from dust and dirt:

- Disconnect the fan from the electric mains (Fig. 57).
- Remove the lid by completing steps 1.2. and 1.3 or 2.2. to 2.4 in the «Installation and set-up» section.
- Undo the self-tapping screws securing the scroll casing, press to disengage the tabs and remove the scroll casing (Fig. 58).
- Turn the scroll 180° to access the turbine and remove the dirt deposits using a soft brush or compressed air (Fig. 59).
- Re-assemble the fan in the reverse order and re-connect it to power mains (Fig. 60).

WARNING! Avoid spilling liquid on the electrical components!

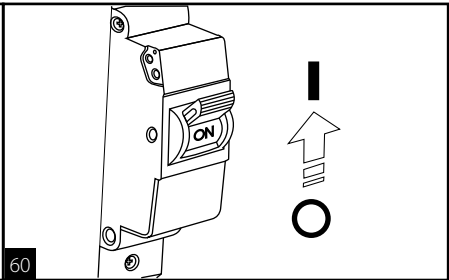
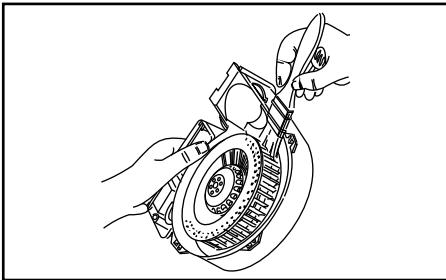
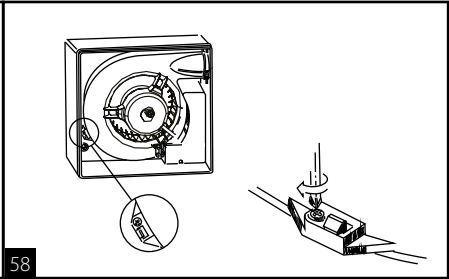
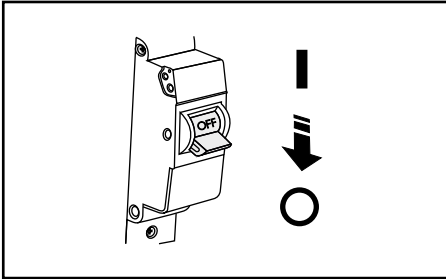

TROUBLESHOOTING

Problem	Possible reasons	Troubleshooting
When the unit is connected to power mains, the fan does not rotate and does not respond to any controls.	No power supply.	Make sure the power supply line is connected correctly, otherwise troubleshoot the connection error.
	Internal connection fault.	Contact the Seller.
Low air flow.	The ventilation system is clogged.	Clean the ventilation system.
Increased noise, vibration.	The impeller is clogged.	Clean the impeller.
	The fan is not secured well or is not mounted properly.	Troubleshoot the installation error.
	The ventilation system is clogged.	Clean the ventilation system.

STORAGE AND TRANSPORTATION REGULATIONS

- Store the unit in the manufacturer's original packaging box in a dry closed ventilated premise with temperature range from +5 °C to + 40 °C and relative humidity up to 70 %.
- Storage environment must not contain aggressive vapors and chemical mixtures provoking corrosion, insulation, and sealing deformation.
- Use suitable hoist machinery for handling and storage operations to prevent possible damage to the unit.
- Follow the handling requirements applicable for the particular type of cargo.
- The unit can be carried in the original packaging by any mode of transport provided proper protection against precipitation and mechanical damage. The unit must be transported only in the working position.
- Avoid sharp blows, scratches, or rough handling during loading and unloading.
- Prior to the initial power-up after transportation at low temperatures, allow the unit to warm up at operating temperature for at least 3-4 hours.

MANUFACTURER'S WARRANTY

The product is in compliance with EU norms and standards on low voltage guidelines and electromagnetic compatibility. We hereby declare that the product complies with the provisions of Electromagnetic Compatibility (EMC) Directive 2014/30/EU of the European Parliament and of the Council, Low Voltage Directive (LVD) 2014/35/EU of the European Parliament and of the Council and CE-marking Council Directive 93/68/EEC. This certificate is issued following test carried out on samples of the product referred to above.

The manufacturer hereby warrants normal operation of the unit for 60 months after the retail sale date provided the user's observance of the transportation, storage, installation, and operation regulations. Should any malfunctions occur in the course of the unit operation through the Manufacturer's fault during the guaranteed period of operation, the user is entitled to get all the faults eliminated by the manufacturer by means of warranty repair at the factory free of charge. The warranty repair includes work specific to elimination of faults in the unit operation to ensure its intended use by the user within the guaranteed period of operation. The faults are eliminated by means of replacement or repair of the unit components or a specific part of such unit component.

The warranty repair does not include:

- routine technical maintenance
- unit installation/dismantling
- unit setup

To benefit from warranty repair, the user must provide the unit, the user's manual with the purchase date stamp, and the payment paperwork certifying the purchase. The unit model must comply with the one stated in the user's manual. Contact the Seller for warranty service.

The manufacturer's warranty does not apply to the following cases:

- User's failure to submit the unit with the entire delivery package as stated in the user's manual including submission with missing component parts previously dismantled by the user.
- Mismatch of the unit model and the brand name with the information stated on the unit packaging and in the user's manual.
- User's failure to ensure timely technical maintenance of the unit.
- External damage to the unit casing (excluding external modifications as required for installation) and internal components caused by the user.
- Redesign or engineering changes to the unit.

- Replacement and use of any assemblies, parts and components not approved by the manufacturer.
- Unit misuse.
- Violation of the unit installation regulations by the user.
- Violation of the unit control regulations by the user.
- Unit connection to power mains with a voltage different from the one stated in the user's manual.
- Unit breakdown due to voltage surges in power mains.
- Discretionary repair of the unit by the user.
- Unit repair by any persons without the manufacturer's authorization.
- Expiration of the unit warranty period.
- Violation of the unit transportation regulations by the user.
- Violation of the unit storage regulations by the user.
- Wrongful actions against the unit committed by third parties.
- Unit breakdown due to circumstances of insuperable force (fire, flood, earthquake, war, hostilities of any kind, blockades).
- Missing seals if provided by the user's manual.
- Failure to submit the user's manual with the unit purchase date stamp.
- Missing payment paperwork certifying the unit purchase.



FOLLOWING THE REGULATIONS STIPULATED HEREIN WILL ENSURE A LONG AND TROUBLE-FREE OPERATION OF THE UNIT



USER'S WARRANTY CLAIMS SHALL BE SUBJECT TO REVIEW ONLY UPON PRESENTATION OF THE UNIT, THE PAYMENT DOCUMENT AND THE USER'S MANUAL WITH THE PURCHASE DATE STAMP

Quality Inspector's Stamp

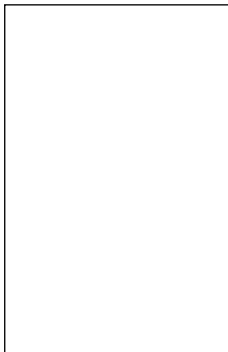

Sold by
(name and stamp of the seller)

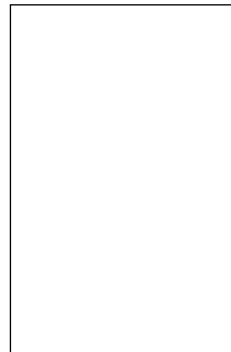

Manufacture Date

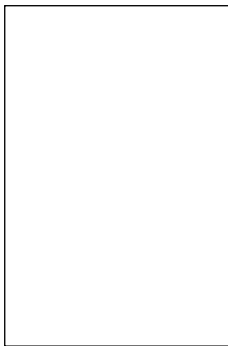

Purchase Date

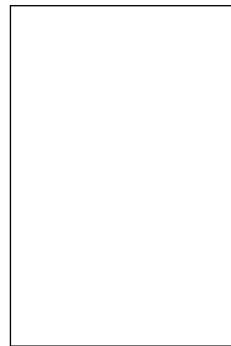

Valeo _____

Case _____

