

Turbo

Inline mixed-flow fans

Use

- Supply and extract ventilation systems installed in various premises.
- Mounting in kitchens, bathrooms and other humid premises.
- Ventilation air ducts requiring high pressure, powerful air flow and low noise level.
- Compatible with Ø 100 up to 315 mm round air ducts.



Air flow:
up to 1750 m³/h
486 l/s



Power:
from 23 W



Noise level:
from 27 dBA



Design

- The casing is made of low-flammable polypropylene.
- Ventilation unit with terminal box. Can be turned to any position.
- Special design of the casing permits easy dismantling of the impeller and motor block for fan servicing without dismantling the air duct.

Motor

- Two-speed single-phase motor on ball bearings.
- Equipped with thermal overheating protection.

Speed control

- The control (minimum speed, maximum speed and shutdown) is executed with the integrated three-position switch (**US** modification) or with the external switch for multi-speed fans (specially ordered accessory).
- Smooth speed control is possible with a built-in speed controller (**FR1** modification) or an external thyristor speed controller (available upon separate order).

Mounting









- Due to the compact design the fan is the ideal solution for mounting in limited spaces, including space behind a false ceiling.
- The fan can be installed in any section of the ventilation system from intake to the end of the ductworks.
- Wall or ceiling mounting with a mounting plate.
- TD:** mounting kit for installation of one diameter fans in parallel (for boosting capacity)



- TL:** mounting kit for installation of one diameter fans in series (for boosting pressure).



Accessories

Silencers	Filter boxes	Electric heaters	Water heaters	Backdraft air dampers	Air dampers	Clamps	Temperature controllers	Speed controllers	Timers/Sensors
									
SD	KFBK / KFBT	EKH	WKH	VRV	VK / VKA	K	MLCD E2	CDT / CDP	TE(TI) / HSE(HSI) / LSE(LSI) / IRSE(IRSI)

Modifications

- o **T:** turn-off delay timer adjustable from 2 to 30 minutes.
- o **US:** three-position speed switch.



- o **FR1:** smooth speed controller adjustable from 0 to 100 % and power cable with mains plug.



- o **G1:** speed controller, temperature controller with external temperature sensor (cable length 4 m), power cable with mains plug.



- o **GT1:** speed controller, temperature controller with external temperature sensor (cable length 4 m), 5 min timer switch and power cable with mains plug.
- o **G11:** speed controller, temperature controller with integrated temperature sensor and power cable with mains plug.
- o **GT11:** speed controller, temperature controller with integrated temperature sensor, 5 min timer switch and power cable with mains plug.
- o The **G1** and **G11** modifications enable automatic speed control depending on indoor temperature. The optimal ventilation solution for premises requiring permanent temperature control as greenhouses, orangeries, etc.
- o **W1:** power cable with mains plug.

Designation key		
Series	Duct diameter [mm]	Modifications
Turbo	100; 125; 150; 160; 200; 250; 315	T: turn-off delay timer adjustable from 2 to 30 minutes US: three-position speed switch FR1: smooth speed controller adjustable from 0 to 100 % and power cable with mains plug G1: speed controller, temperature controller with external temperature sensor, power cable with mains plug GT1: speed controller, temperature controller with external temperature sensor, 5 min timer switch and power cable with mains plug G11: speed controller, temperature controller with integrated temperature sensor and power cable mains plug GT11: speed controller, temperature controller with integrated temperature sensor, 5 min timer switch and power cable with mains plug W1: power cable with mains plug

Overall dimensions [mm]

Model	Ø D	Ø D1	B	H	L	Weight [kg]
Turbo 100	97	164	196	241	303	1.68
Turbo 125	123	164	196	241	258	1.79
Turbo 150	148	187	220	251	289	3.18
Turbo 160	158	187	220	251	289	3.23
Turbo 200	199	209	239	261	295.5	3.8
Turbo 250	247	257	287	323	383	7.83
Turbo 315	310	323	362	408	445	11.7

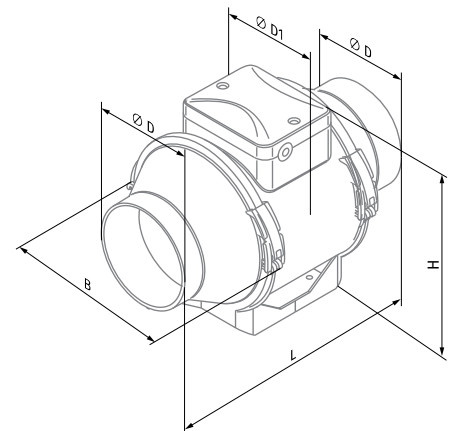

Technical data

Parameters	Turbo 100		Turbo 125		Turbo 150 / Turbo 160	
Speed	min	max	min	max	min	max
Voltage [V]	1 ~ 230		1 ~ 230		1 ~ 230	
Frequency [Hz]	50/60		50/60		50/60	
Power [W]	23		25		42	
Current [A]	0.10		0.11		0.19	
Maximum air flow [m ³ /h (l/s)]	170 (47)		220 (61)		430 (119)	
RPM [min ⁻¹]	1980		1535		2265	
Sound pressure level at 3 m [dBA]	27		29		32	
Max. transported air temperature [°C]	+60		+60		+60	
SEC class	C		B		B	
IP rating	IPX4		IPX4		IPX4	
Motor IP rating	IPX4		IPX4		IPX4	
ErP	-		-		2018	

To comply with ErP 2018 it is necessary to use a speed controller and local demand control typology (connect the sensor).

TURBO 100

Sound power level, A-weighted	Total	Octave frequency bands [Hz]								LpA 3 m	LpA 1 m
		63	125	250	500	1000	2000	4000	8000		
Min speed											
L _{WA} to inlet [dBA]	54	19	35	50	49	44	37	25	17	33	43
L _{WA} to outlet [dBA]	53	17	34	50	49	48	36	24	17	32	42
L _{WA} to environment [dBA]	47	14	29	43	43	39	33	22	15	27	37
Max speed											
L _{WA} to inlet [dBA]	59	24	34	53	54	53	48	37	26	38	48
L _{WA} to outlet [dBA]	57	23	33	52	52	52	47	37	26	37	47
L _{WA} to environment [dBA]	52	18	29	46	48	47	43	33	23	32	42

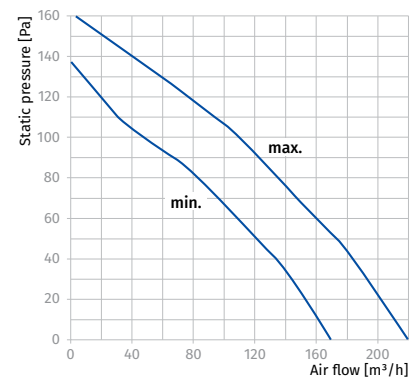

TURBO 125

Sound power level, A-weighted	Total	Octave frequency bands [Hz]								LpA 3 m	LpA 1 m
		63	125	250	500	1000	2000	4000	8000		
Min speed											
L _{WA} to inlet [dBA]	54	26	38	52	50	44	38	27	17	34	44
L _{WA} to outlet [dBA]	54	25	37	51	49	43	38	28	18	33	43
L _{WA} to environment [dBA]	49	21	32	46	45	40	35	25	16	29	39
Max speed											
L _{WA} to inlet [dBA]	60	20	31	57	51	51	50	39	27	39	49
L _{WA} to outlet [dBA]	59	20	31	56	51	51	49	39	26	38	48
L _{WA} to environment [dBA]	54	16	27	51	46	47	45	36	24	34	44

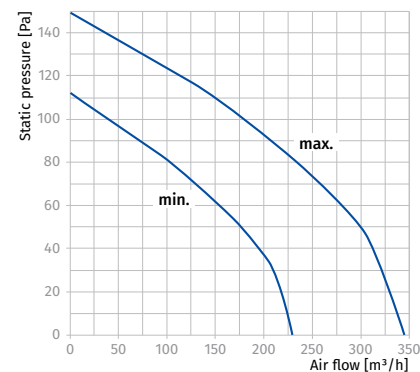

TURBO 150 / 160

Sound power level, A-weighted	Total	Octave frequency bands [Hz]								LpA 3 m	LpA 1 m
		63	125	250	500	1000	2000	4000	8000		
Min speed											
L _{WA} to inlet [dBA]	59	31	45	54	52	54	48	35	29	38	48
L _{WA} to outlet [dBA]	63	37	49	56	56	60	48	39	30	42	52
L _{WA} to environment [dBA]	52	21	30	48	48	45	42	34	23	32	42
Max speed											
L _{WA} to inlet [dBA]	69	38	51	57	62	60	66	49	44	48	58
L _{WA} to outlet [dBA]	72	42	55	66	67	68	65	53	45	52	62
L _{WA} to environment [dBA]	65	23	37	56	59	57	61	47	35	44	54

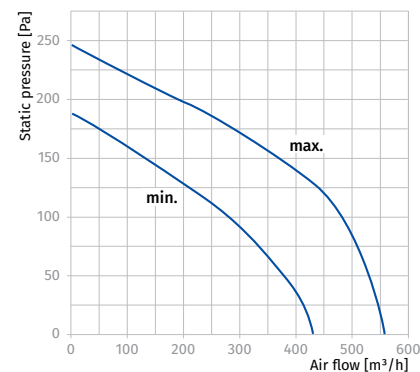

Parameters	Turbo 200		Turbo 250		Turbo 315	
Speed	min	max	min	max	min	max
Voltage [V]	1 ~ 230	1 ~ 230	1 ~ 230	1 ~ 230	1 ~ 230	1 ~ 230
Frequency [Hz]	50/60	50/60	50/60	50/60	50/60	50/60
Power [W]	76	108	125	177	227	315
Current [A]	0.34	0.48	0.54	0.79	0.99	1.42
Maximum air flow [m³/h (l/s)]	805 (224)	1080 (300)	1070 (297)	1360 (378)	1420 (394)	1750 (486)
RPM [min ⁻¹]	1915	2380	1955	2440	2115	2505
Sound pressure level at 3 m [dBA]	39	45	44	51	41	52
Max. transported air temperature [°C]	+60		+60		+60	
SEC class	B		-		-	
IP rating	IPX4		IPX4		IPX4	
Motor IP rating	IPX4		IPX4		IPX4	
ErP	2018		2018		2018	

To comply with ErP 2018 it is necessary to use a speed controller and local demand control typology (connect the sensor).

TURBO 200

Sound power level, A-weighted	Total	Octave frequency bands [Hz]								LpA 3 m	LpA 1 m
		63	125	250	500	1000	2000	4000	8000		
Min speed											
LWA to inlet [dBA]	66	38	50	58	59	60	59	55	45	45	55
LWA to outlet [dBA]	64	40	50	54	58	59	57	51	44	43	53
LWA to environment [dBA]	60	27	42	49	54	55	54	46	34	39	49
Max speed											
LWA to inlet [dBA]	71	41	50	63	64	65	64	62	52	50	60
LWA to outlet [dBA]	70	43	52	61	66	64	63	58	51	50	60
LWA to environment [dBA]	65	34	43	54	60	60	60	53	41	45	55

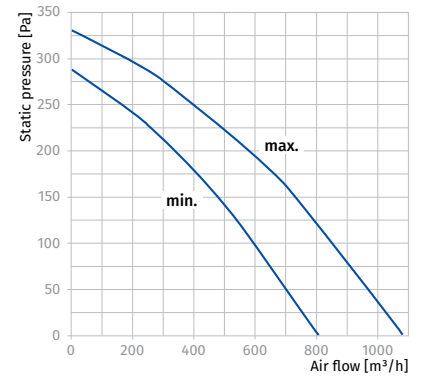

TURBO 250

Sound power level, A-weighted	Total	Octave frequency bands [Hz]								LpA 3 m	LpA 1 m
		63	125	250	500	1000	2000	4000	8000		
Min speed											
LWA to inlet [dBA]	72	48	57	63	66	69	64	54	45	52	62
LWA to outlet [dBA]	75	48	56	64	70	71	66	56	45	54	64
LWA to environment [dBA]	65	32	51	57	61	59	56	45	32	44	54
Max speed											
LWA to inlet [dBA]	78	52	62	66	71	75	72	62	52	58	68
LWA to outlet [dBA]	81	52	60	66	76	77	74	63	52	60	70
LWA to environment [dBA]	72	35	50	63	69	66	63	53	40	51	61

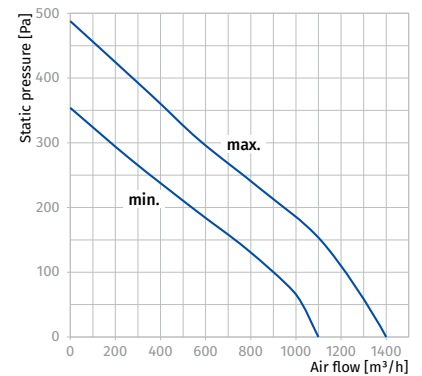

TURBO 315

Sound power level, A-weighted	Total	Octave frequency bands [Hz]								LpA 3 m	LpA 1 m
		63	125	250	500	1000	2000	4000	8000		
Min speed											
LWA to inlet [dBA]	72	43	54	62	67	66	67	58	47	52	62
LWA to outlet [dBA]	70	45	57	59	64	66	63	56	46	50	60
LWA to environment [dBA]	62	28	51	53	57	57	54	46	36	41	51
Max speed											
LWA to inlet [dBA]	80	50	59	68	73	77	74	70	59	60	70
LWA to outlet [dBA]	78	51	60	66	70	75	71	66	57	58	68
LWA to environment [dBA]	72	37	51	66	66	67	65	58	48	52	62

