

# SMART Wi-Fi

Ø100/125

Axial intelligent fan  
USER'S MANUAL



## CONTENTS

Delivery set.....	7
Operation guidelines .....	7
Installation and set-up.....	10
Connection to power mains .....	12
Fan control.....	13
Special «setup mode/reset».....	13
Battery replacement .....	14
Technical maintenance.....	15
Troubleshooting.....	16
Storage and transportation regulations.....	16
Manufacturer's warranty .....	17

This user's manual is a main operating document intended for technical, maintenance, and operating staff.

The manual contains information about purpose, technical details, operating principle, design, and installation of the Smart Wi-Fi unit and all its modifications.

Technical and maintenance staff must have theoretical and practical training in the field of ventilation systems and should be able to work in accordance with workplace safety rules as well as construction norms and standards applicable in the territory of the country.



**READ THE USER'S MANUAL CAREFULLY BEFORE PROCEEDING WITH INSTALLATION WORKS.**

**COMPLIANCE WITH THE MANUAL REQUIREMENTS ENSURES RELIABLE OPERATION AND LONG SERVICE LIFE OF THE UNIT. KEEP THE USER'S MANUAL AVAILABLE AS LONG AS YOU USE THE UNIT. YOU MAY NEED TO REREAD THE INFORMATION ON THE PRODUCT SERVICING.**

This unit is not intended for use by persons (including children) with reduced physical, sensory or mental capabilities, or lack of experience and knowledge, unless they have been given supervision or instruction concerning use of the unit by a person responsible for their safety. Children should be supervised to ensure that they do not play with the unit.

This appliance can be used by children aged from 8 years and above and persons with reduced physical, sensory or mental capabilities or lack of experience and knowledge if they have been given supervision or instruction concerning use of the appliance in a safe way and understand the hazards involved.

Cleaning and user maintenance shall not be made by children without supervision. Children shall not play with the appliance.

Precautions must be taken to avoid the back-flow of gases into the room from the open flue of gas or other fuel-burning appliances.

The appliance may adversely affect the safe operation of appliances burning gas or other fuels (including those in other rooms) due to back flow of combustion gases. These gases can potentially result in carbon monoxide poisoning. After installation of the unit the operation of flued gas appliances should be tested by a competent person to ensure that back flow of combustion gases does not occur.

Connection to the mains must be made through a disconnecting device, which is integrated into the fixed wiring system in accordance with the wiring rules for design of electrical units, and has a contact separation in all poles that allows for full disconnection under overvoltage category III conditions.

Do not attach the product to the support using glue or adhesives. Use only the fastening method specified in the «User's manual».

All operations described in this manual must be performed by qualified personnel only, properly trained and qualified to install, make electrical connections and maintain ventilation units.

Do not attempt to install the product, connect it to the mains, or perform maintenance yourself. This is unsafe and impossible without special knowledge.

Disconnect the power supply prior to any operations with the unit.

All user's manual requirements as well as the provisions of all the applicable local and national construction, electrical, and technical norms and standards must be observed when installing and operating the unit.

Disconnect the unit from the power supply prior to any connection, servicing, maintenance, and repair operations.

**Only qualified electricians with a work permit for electrical units up to 1000 V are allowed for installation. The present user's manual should be carefully read before beginning works.**

Check the unit for any visible damage of the impeller, the casing, and the grille before starting installation. The casing internals must be free of any foreign objects that can damage the impeller blades.

While mounting the unit, avoid compression of the casing! Deformation of the casing may result in motor jam and excessive noise.

Misuse of the unit and any unauthorised modifications are not allowed.

Do not expose the unit to adverse atmospheric agents (rain, sun, etc.).

Transported air must not contain any dust or other solid impurities, sticky substances, or fibrous materials.

Do not use the unit in a hazardous or explosive environment containing spirits, gasoline, insecticides, etc.

Do not close or block the intake or extract vents in order to ensure the efficient air flow.

Do not sit on the unit and do not put objects on it.

The information in this user's manual was correct at the time of the document's preparation.

The Company reserves the right to modify the technical characteristics, design, or configuration of its products at any time in order to incorporate the latest technological developments.

Never touch the unit with wet or damp hands.

Never touch the unit when barefoot.

BEFORE INSTALLING ADDITIONAL EXTERNAL DEVICES, READ THE RELEVANT USER MANUALS.



**THE PRODUCT MUST BE DISPOSED SEPARATELY AT THE END OF ITS SERVICE LIFE.  
DO NOT DISPOSE THE UNIT AS UNSORTED DOMESTIC WASTE.**

---

## DELIVERY SET

Fan	1 pc.
Logo	1 pc.
Spigot Ø 100 mm	1 pc.
Spigot Ø 125 mm	1 pc.
Screws and dowels	4 pcs.
User's manual	1 pc.
Packing box	1 pc.

## OPERATION GUIDELINES

The fan is designed for connection to single-phase AC power mains 100-240 V, 50/60 Hz.

Ingress protection rating against access to hazardous parts and water ingress is IP44.

The fan is rated for operation at the ambient temperature ranging from +1 °C up to +40 °C.

The unit is rated as a Class II electrical appliance.

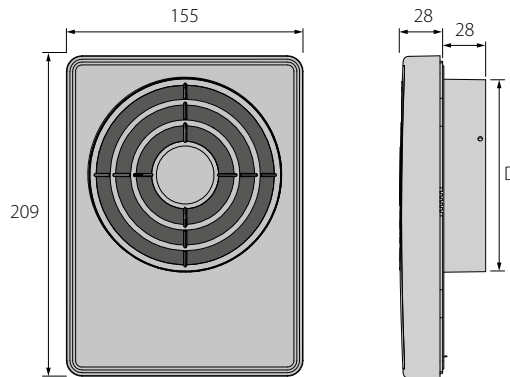
**Overall dimensions**

**FAN MODIFICATIONS**

Model	Functions							
	Humidity control	24 hours	Turn-on delay timer	Turn-off delay timer	Speed control	Interval ventilation	External switch	Motion sensor
Smart Wi-Fi	+	+	+	+	+	+	+	
Smart Wi-Fi IR	+	+	+	+	+	+	+	+



### Wi-Fi technical data

Standard	IEEE 802,11, b/g/n
Frequency band [GHz]	2.4
Transmission power [mW] (dBm)	100(+20)
Network	DHCP
WLAN safety	WPA, WPA2

### Fan operation modes

**Standby mode** – the fan motor does not rotate, the rotation is activated when the **24 hours** mode is activated by a mobile application or by a signal from a temperature/humidity/motion and external switch.

**24 hours** - fan operation at low speed to ensure minimum round-the-clock ventilation.

When the motion, temperature or humidity sensor/external switch is triggered, the fan switches to **Silent** or **Max** modes.

**Silent** – silent operation mode of the fan. This mode is activated by a motion sensor.

**Max** – high-speed fan operation mode, which is activated when a humidity or temperature sensor is triggered or **Boost Mode** is activated via the mobile application.

## INSTALLATION AND SET-UP

1. In case of vertical mounting the fan must be protected against water and condensation collecting inside the fan.

Fan installation with direct air discharge upwards is not allowed.

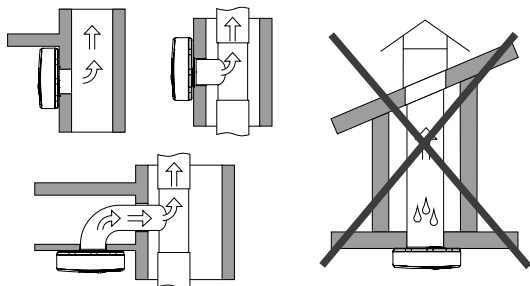

3. Remove the front panel of the fan.

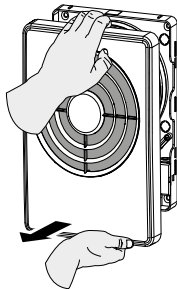

2. Before starting the installation, make sure all electricity has been turned off!

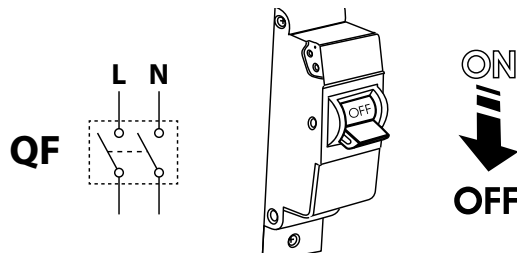

4. Mark the holes for fixing the fan and the power cable.

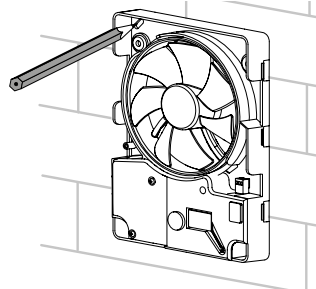

5. Lead the power cable to the ventilation hole, drill the mounting holes and install the dowels.

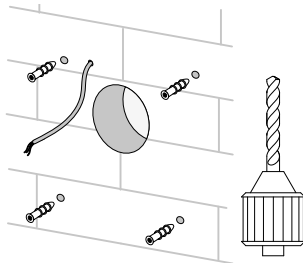

6. Fix the fan with the screws.

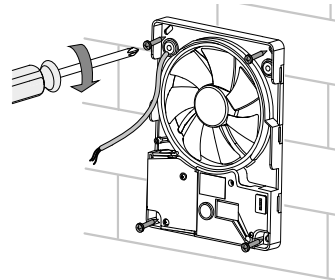

7. Remove the cover to access the terminal block and connect the fan to power mains according to the wiring diagram. Assemble the fan in the reverse order.

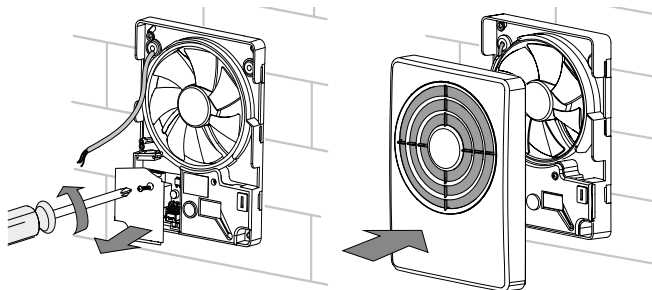

8. Supply power to the fan.

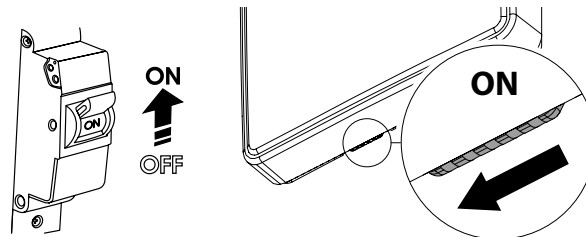

## CONNECTION TO POWER MAINS

The fan is rated for connection to single-phase AC power mains 100-240 V/50 (60) Hz.

### Terminal designations on wiring diagrams:

**L** – phase

**N** – 0

**LT** – fan speed control circuit

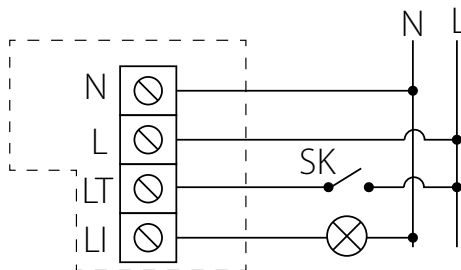

**LI** – output for external load connection

**SK** – external switch for switching the fan to Silent speed.



## FAN CONTROL

To control the product from a mobile device, install the application

<a href="#">Blauberg Home – App Store</a>	<a href="#">Blauberg Home – Play Market</a>
	

To start operating the fan, it is necessary to connect to it as a Wi-Fi access point with the name (FAN: + 16 characters of the ID number) indicated on the control board and on the fan casing. **Wi-Fi access point password:** 11111111.

In the application, you can configure the fan to connect via a home Wi-Fi network.

### SPECIAL «SETUP MODE/RESET»

To restore the Wi-Fi password or connect to the fan in order to change the settings, **Setup Mode** is provided .

To enter the **Setup Mode**, press and hold the button below the front panel of the ventilator for 5 seconds until the LED starts blinking blue. The unit will continue in this mode for 3 minutes and then will automatically revert to the previous settings.

To immediately exit the setup mode, press and hold the button again for 4 seconds until the LED stops blinking blue and starts glowing red. In **Setup Mode**, connect to the fan using a mobile device:

**Wi-Fi name:** Setup mode.

**Wi-Fi password:** 11111111.

To reset factory settings, press and hold the button for 14 seconds until the LED starts blinking red and a beep is produced.

## Access to the Setup Mode button

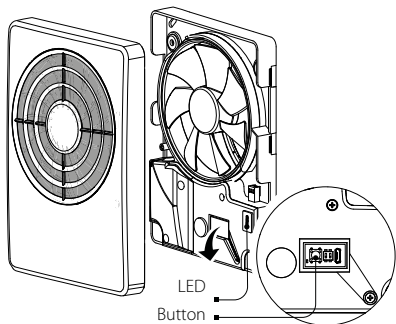

### The LED has the following states:

- **Switched off.** Normal operation mode of the device.
- **Glowing blue.** Warning of switching the device to the **Setup Mode.**
- **Blinking blue.** The device is in Setup Mode.
- **Glowing red.** Warning of return to factory settings or exit from the **Setup Mode.**
- **Blinking red.** All the fan parameters are successfully reset to factory settings.

## BATTERY REPLACEMENT

If the battery is low or dead, the corresponding warning indicator appears on the home page in the application (see page 16).

If such an indicator appears on the home page, replace the battery.

To do this, power off the fan, remove the front panel and the cover protecting the control circuit board.

Replace the battery (battery type – CR1220) located on the control board.

Reassemble the fan in reverse order, then apply power to the fan.

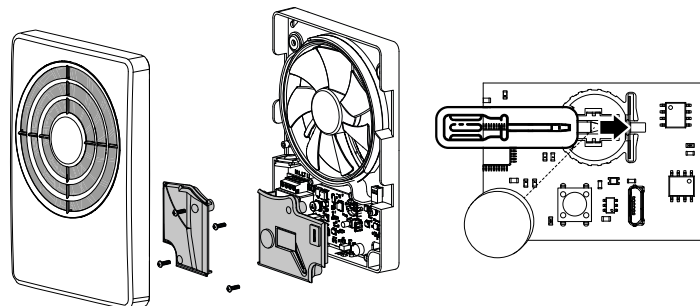

## TECHNICAL MAINTENANCE

1. Turn the lock button on the fan to the lock position.

Fan operation will be locked.

**WARNING! The locking does not remove the voltage from the fan power terminals!**

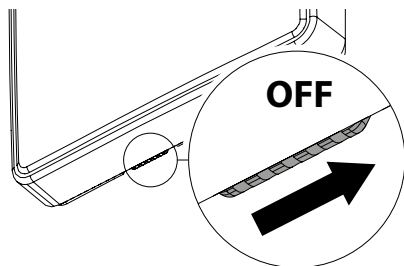

3. Wash the front panel under running water.

Wipe the front panel surface dry.

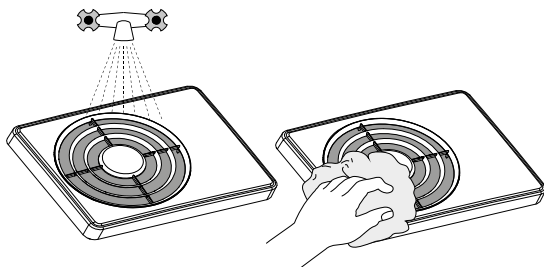

2. Remove the front panel.

Clean the fan blades with a soft dry cloth or brush.

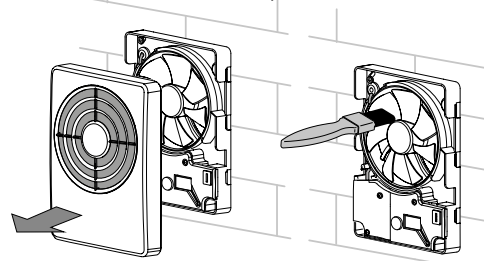

4. Set the lock button to the working position.

Then activate the fan from the mobile application.

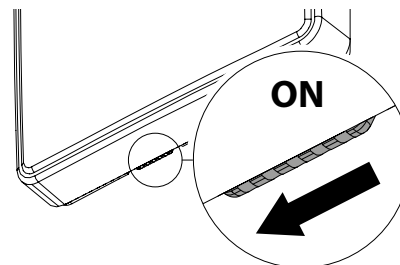

## TROUBLESHOOTING

<b>Malfunction</b>	<b>Probable reasons</b>	<b>Method of elimination</b>
When connected to the network, the fan does not rotate, does not respond to controls.	The power supply network is not connected.	Make sure the power supply is connected correctly, otherwise, fix the connection error.
	Internal connection failure.	Switch off the unit. Contact the service center.
Low air consumption.	Clogged ventilation system.	Clean the ventilation system.
Increased noise, vibration.	Clogged impeller.	Clean the impeller.
	The fan is not secured or mounted incorrectly.	Fix the installation error.
	Clogged ventilation system.	Clean the ventilation system.

## STORAGE AND TRANSPORTATION REGULATIONS

- Store the unit in the manufacturer's original packaging box in a dry closed ventilated premise with temperature range from +5 °C to + 40 °C and relative humidity up to 70 %.
- Storage environment must not contain aggressive vapors and chemical mixtures provoking corrosion, insulation, and sealing deformation.
- Use suitable hoist machinery for handling and storage operations to prevent possible damage to the unit.
- Follow the handling requirements applicable for the particular type of cargo.
- The unit can be carried in the original packaging by any mode of transport provided proper protection against precipitation and mechanical damage. The unit must be transported only in the working position.
- Avoid sharp blows, scratches, or rough handling during loading and unloading.
- Prior to the initial power-up after transportation at low temperatures, allow the unit to warm up at operating temperature for at least 3-4 hours.



## **MANUFACTURER'S WARRANTY**

The product is in compliance with EU norms and standards on low voltage guidelines and electromagnetic compatibility. We hereby declare that the product complies with the provisions of Electromagnetic Compatibility (EMC) Directive 2014/30/EU of the European Parliament and of the Council, Low Voltage Directive (LVD) 2014/35/EU of the European Parliament and of the Council and CE-marking Council Directive 93/68/EEC. This certificate is issued following test carried out on samples of the product referred to above.

The manufacturer hereby warrants normal operation of the unit for 24 months after the retail sale date provided the user's observance of the transportation, storage, installation, and operation regulations. Should any malfunctions occur in the course of the unit operation through the Manufacturer's fault during the guaranteed period of operation, the user is entitled to get all the faults eliminated by the manufacturer by means of warranty repair at the factory free of charge. The warranty repair includes work specific to elimination of faults in the unit operation to ensure its intended use by the user within the guaranteed period of operation. The faults are eliminated by means of replacement or repair of the unit components or a specific part of such unit component.

### **The warranty repair does not include:**

- routine technical maintenance
- unit installation/dismantling
- unit setup

To benefit from warranty repair, the user must provide the unit, the user's manual with the purchase date stamp, and the payment paperwork certifying the purchase. The unit model must comply with the one stated in the user's manual. Contact the Seller for warranty service.

### **The manufacturer's warranty does not apply to the following cases:**

- User's failure to submit the unit with the entire delivery package as stated in the user's manual including submission with missing component parts previously dismantled by the user.
- Mismatch of the unit model and the brand name with the information stated on the unit packaging and in the user's manual.
- User's failure to ensure timely technical maintenance of the unit.
- External damage to the unit casing (excluding external modifications as required for installation) and internal components caused

by the user.

- Redesign or engineering changes to the unit.
- Replacement and use of any assemblies, parts and components not approved by the manufacturer.
- Unit misuse.
- Violation of the unit installation regulations by the user.
- Violation of the unit control regulations by the user.
- Unit connection to power mains with a voltage different from the one stated in the user's manual.
- Unit breakdown due to voltage surges in power mains.
- Discretionary repair of the unit by the user.
- Unit repair by any persons without the manufacturer's authorization.
- Expiration of the unit warranty period.
- Violation of the unit transportation regulations by the user.
- Violation of the unit storage regulations by the user.
- Wrongful actions against the unit committed by third parties.
- Unit breakdown due to circumstances of insuperable force (fire, flood, earthquake, war, hostilities of any kind, blockades).
- Missing seals if provided by the user's manual.
- Failure to submit the user's manual with the unit purchase date stamp.
- Missing payment paperwork certifying the unit purchase.



**FOLLOWING THE REGULATIONS STIPULATED HEREIN WILL ENSURE A LONG AND TROUBLE-FREE OPERATION OF THE UNIT.**



**USER'S WARRANTY CLAIMS SHALL BE SUBJECT TO REVIEW ONLY UPON PRESENTATION OF THE UNIT, THE PAYMENT DOCUMENT AND THE USER'S MANUAL WITH THE PURCHASE DATE STAMP.**









Quality Inspector's Stamp

Sold by  
(name and stamp of the seller)

Manufacture Date

Purchase Date

