

design konzept



 **BLAUBERG**
Ventilatoren

2

design by Blauberg
konzept

Any style any time

design by Blauberg



konzept

3

Blauberg introduces a new ventilation design solution: **Blauberg Design Konzept** innovative design system. It includes Omega fan, a Decor FB 140x140 s grille, a DPK 100 diffuser and a range of stylish design decorative panels.

Features of the Design Konzept system:

You decide yourself what your fan and interior design will look like

The panels can be changed if you prefer

The entire ventilation system in the house can be designed in the same style



OMEGA

OMEGA



up to **160** m³/h



from **29** dBA



from **8** W



100 and **125** mm



OMEGA

Quiet and energy efficient



EXTRACT FAN

Features:

One of the quietest and most energy efficient fans on the market due to the use of mixed flow impellers, a special air flow rectifier and a modern electric motor

No drafts due to a built-in back valve

40 000 hours of continuous operation

Both wall and ceiling mounting are possible



Compatibility:

All panels

Any style any time

Technical data

	Model features	Spigot diameter [mm]	Air flow [m ³ /h]	Sound pressure level at 3 m distance [dBA]	Power [W]	Voltage [V]	Frequency [Hz]
Omega 100	Standard model	100	90	29	8	220-240	50
Omega 100 (220V/60Hz)	For a frequency of 60 Hz		90	29	8		60
Omega 125	Standard model	125	160	32	17		50
Omega 125 (220V/60Hz)	For a frequency of 60 Hz		160	32	17		60

Additional options:

Turn-off delay timer **(T)**

Turn-off and turn-on delay timer **(TR)**

Humidity sensor **(H)**

Pull cord switch **(S)**

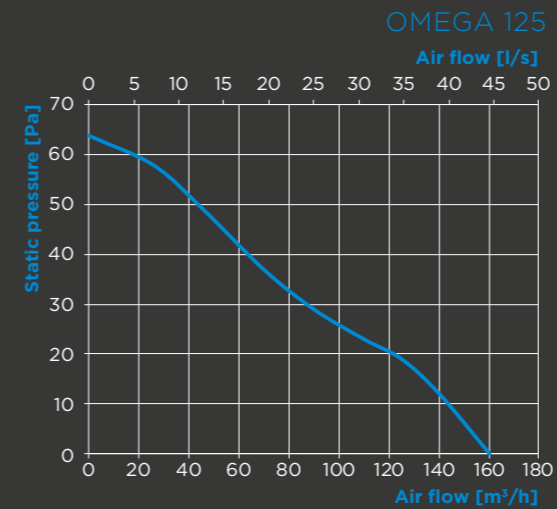
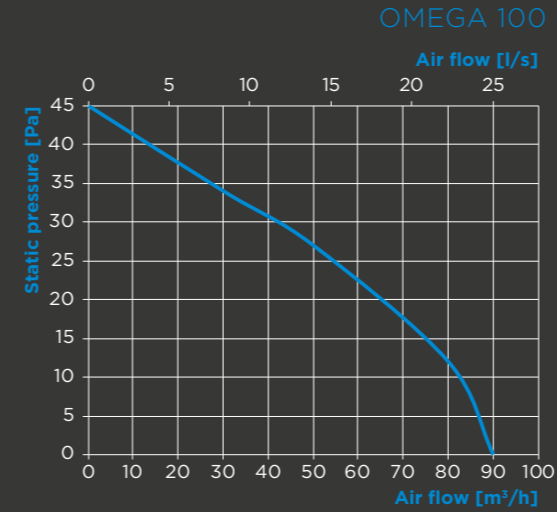

Dimensions [mm]	a	Ød	b	c
Omega 100	150	99	79	36
Omega 125	180	124	85	36

DECOR FB 140x140 s DPK 100



DECOR FB 140x140 s

Dimensions:
140x140 mm

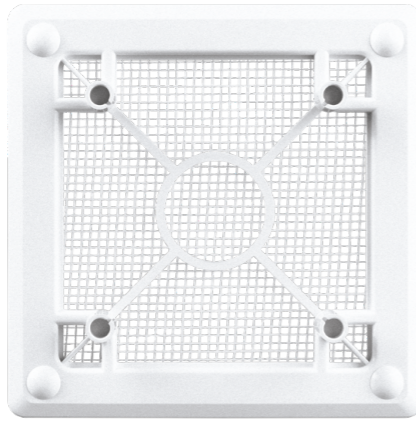

Compatibility:

Plastic
panels

Metal
panels

GRILLE

DPK 100

Spigot diameter:
100 mm

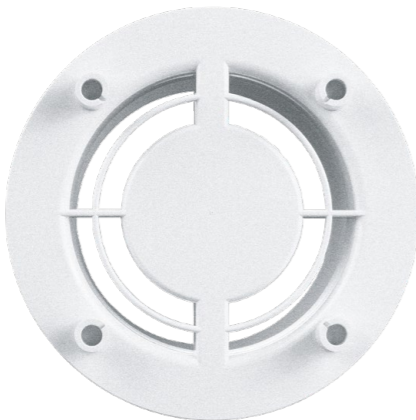

Compatibility:

Plastic
panels

Metal
panels

Glass
panels

DIFFUSER

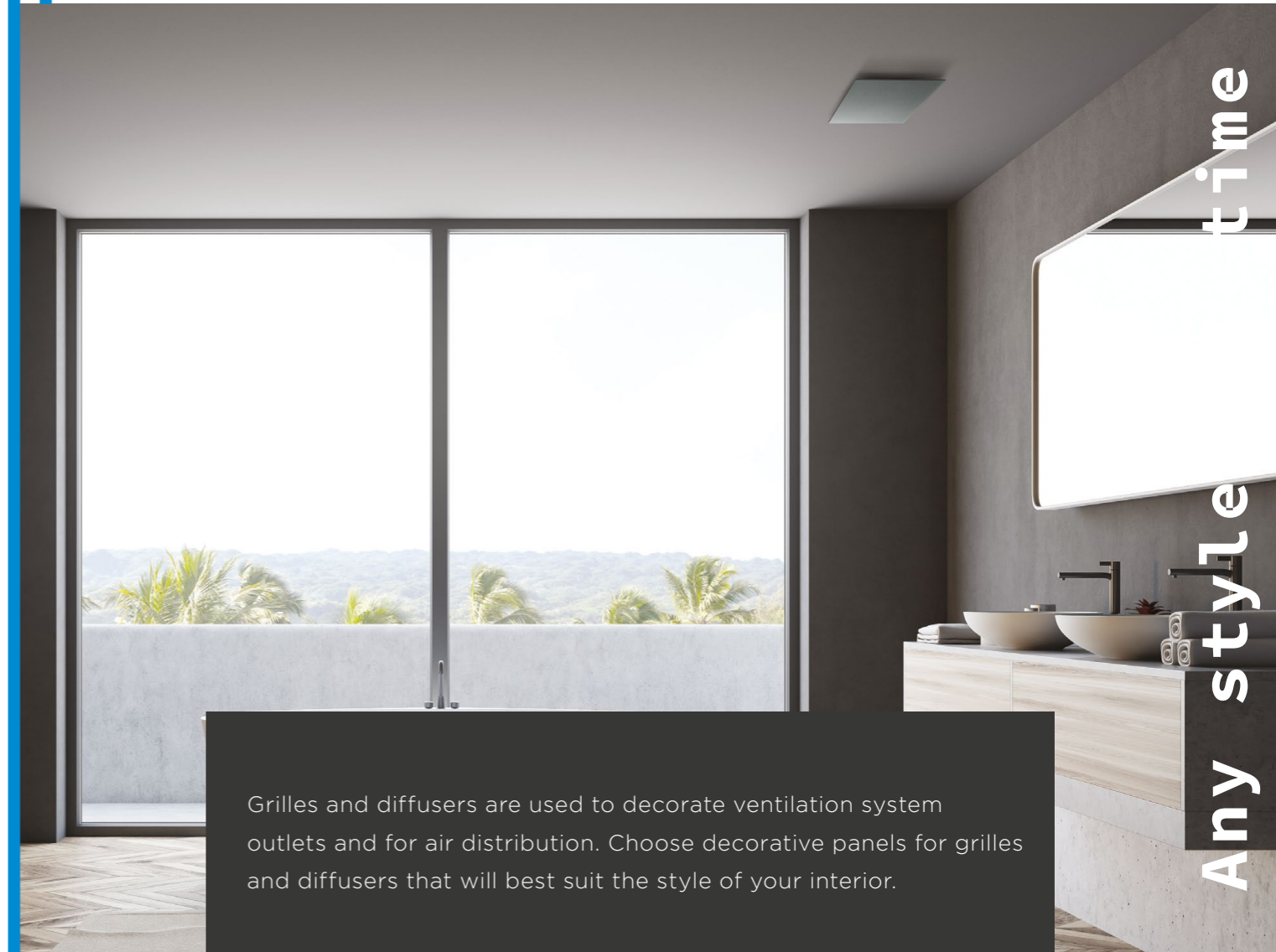

Grilles and diffusers are used to decorate ventilation system outlets and for air distribution. Choose decorative panels for grilles and diffusers that will best suit the style of your interior.

Any style
time

Technical data



DECOR FB
140x140 S

GRILLE

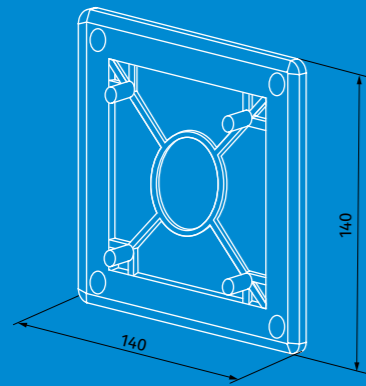
DIMENSIONS [mm]

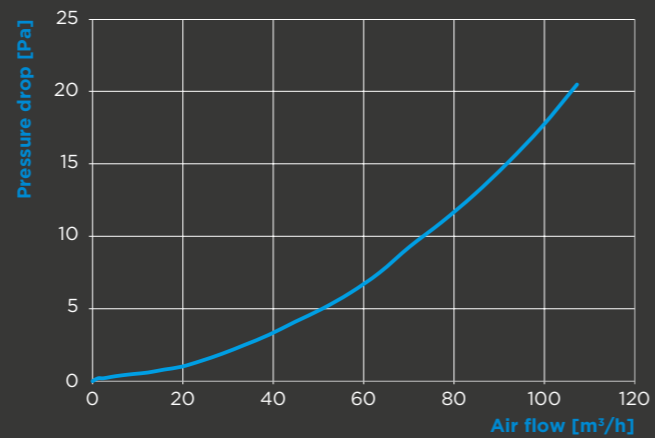

AIR FLOW



 Wall or ceiling mounting

 Reinforced structure

 Equipped with an insect screen for protection against insects and foreign objects
DPK
100

DIFFUSER

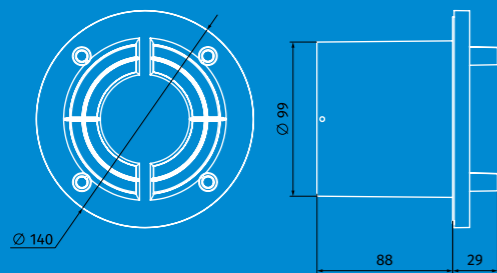
DIMENSIONS [mm]

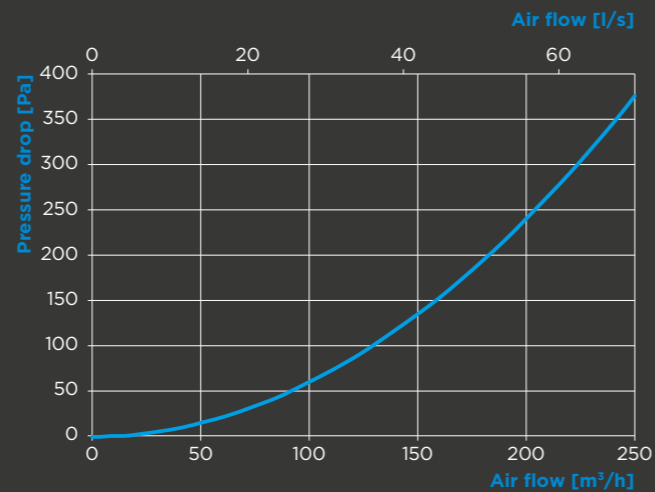

AIR FLOW

 Designed for wall mounting or installation into false ceilings

 Special aerodynamic shape ensures uniform air distribution

 Easy mounting with a mounting flange and screws

 External removable grille for maintenance and cleaning

PANELS

PANELS

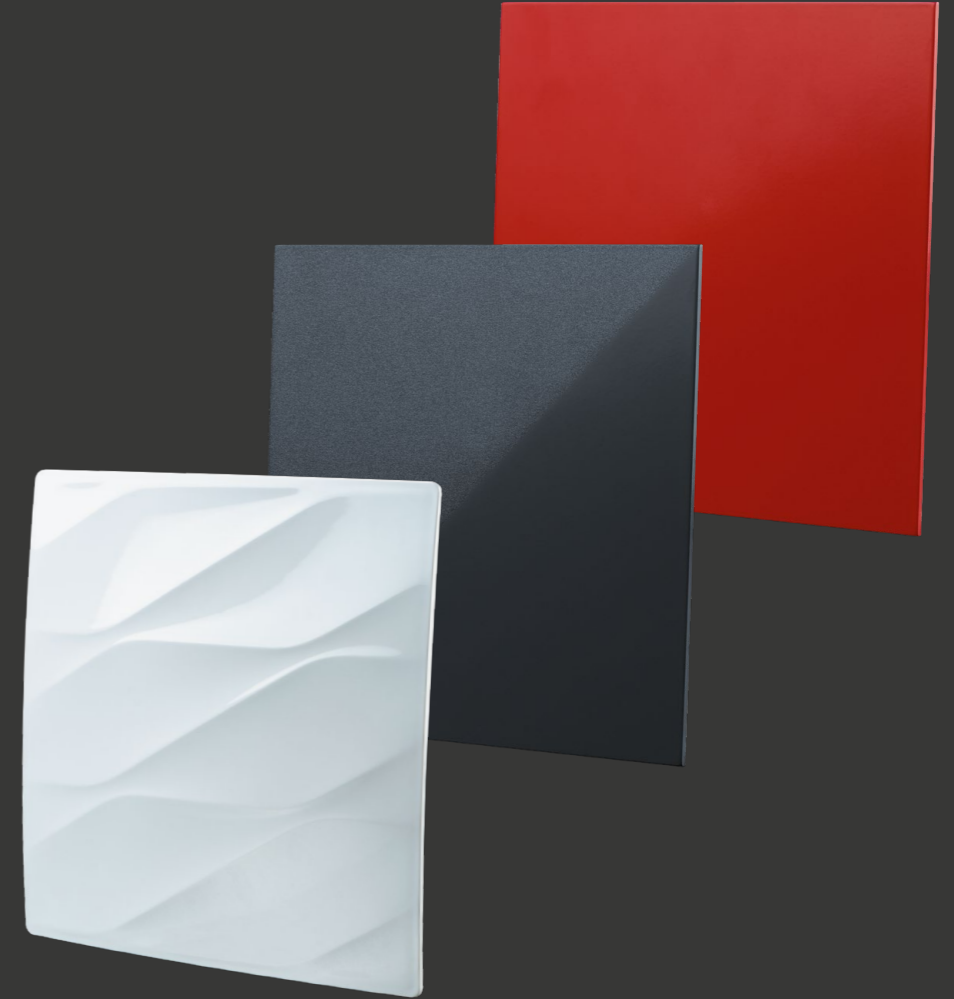

SOPHISTICATION
AND HARMONY
OF FORMS

Any style any time

Panels are compatible with:

—
Omega fan

—
Decor FB 140x140 s
grille

—
DPK 100 diffuser

**DECORATIVE
PANELS FROM
ABS PLASTIC**

Design Konzept System panels are the finishing touch of your home's ventilation design

Made of high quality UV resistant ABS plastic



Plan



Plan Red



Plan Cosmos Black



Platinum

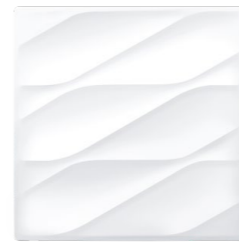

Bavaria



Hi-Fi



Moon



Shield

DECORATIVE PANELS WITH METAL FINISH

If you prefer metal and want to emphasize a unique style, choose panels with metal plates with various visual effects

Compatible with Ø 100 mm and Ø 125 mm fans



Chrome



Hi-Tech

Any style any time

STRENGTH AND STYLE
OF METAL

Panels are compatible with:

—
Omega fan

—
Decor FB 140x140 s grille

—
DPK 100 diffuser

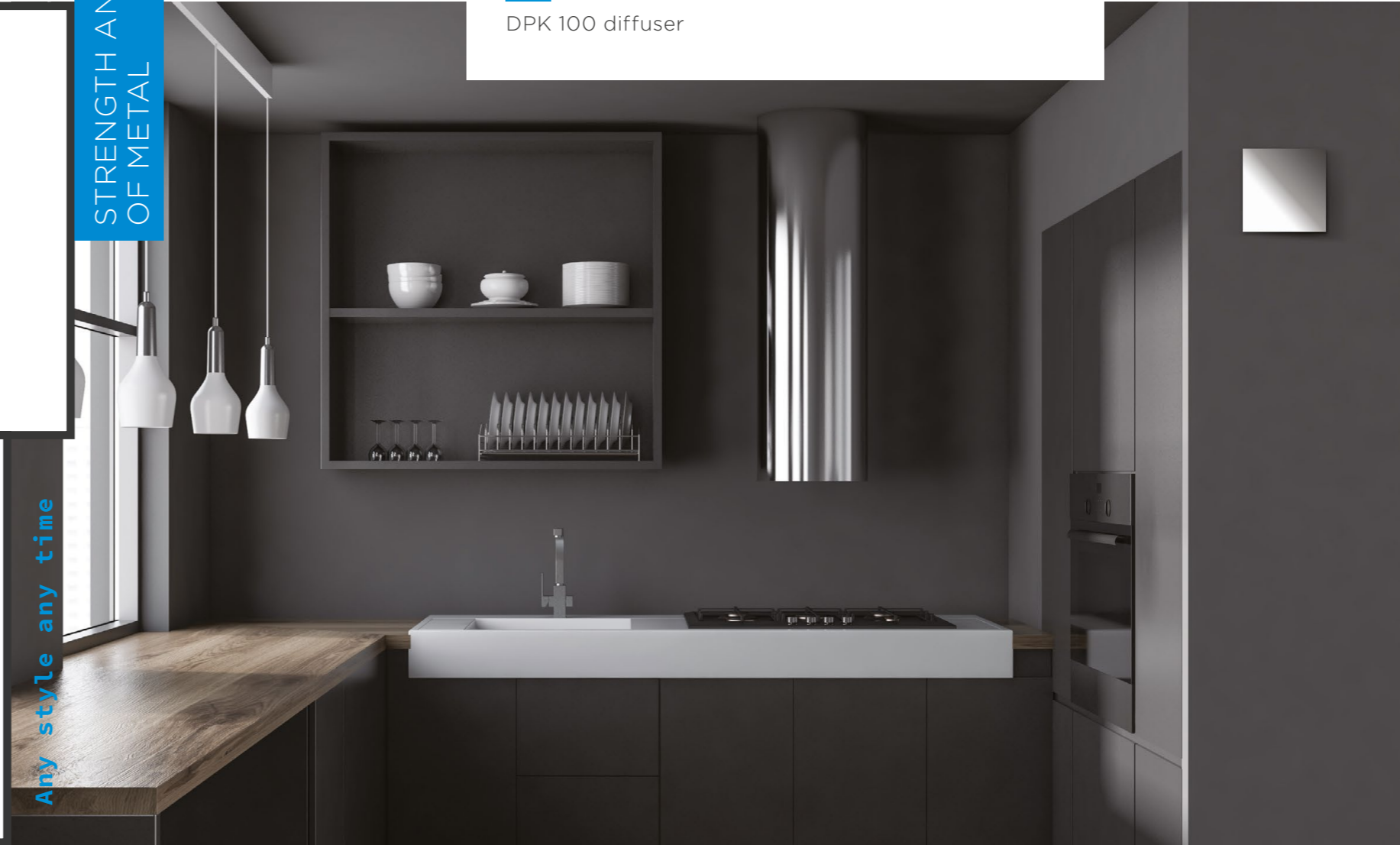

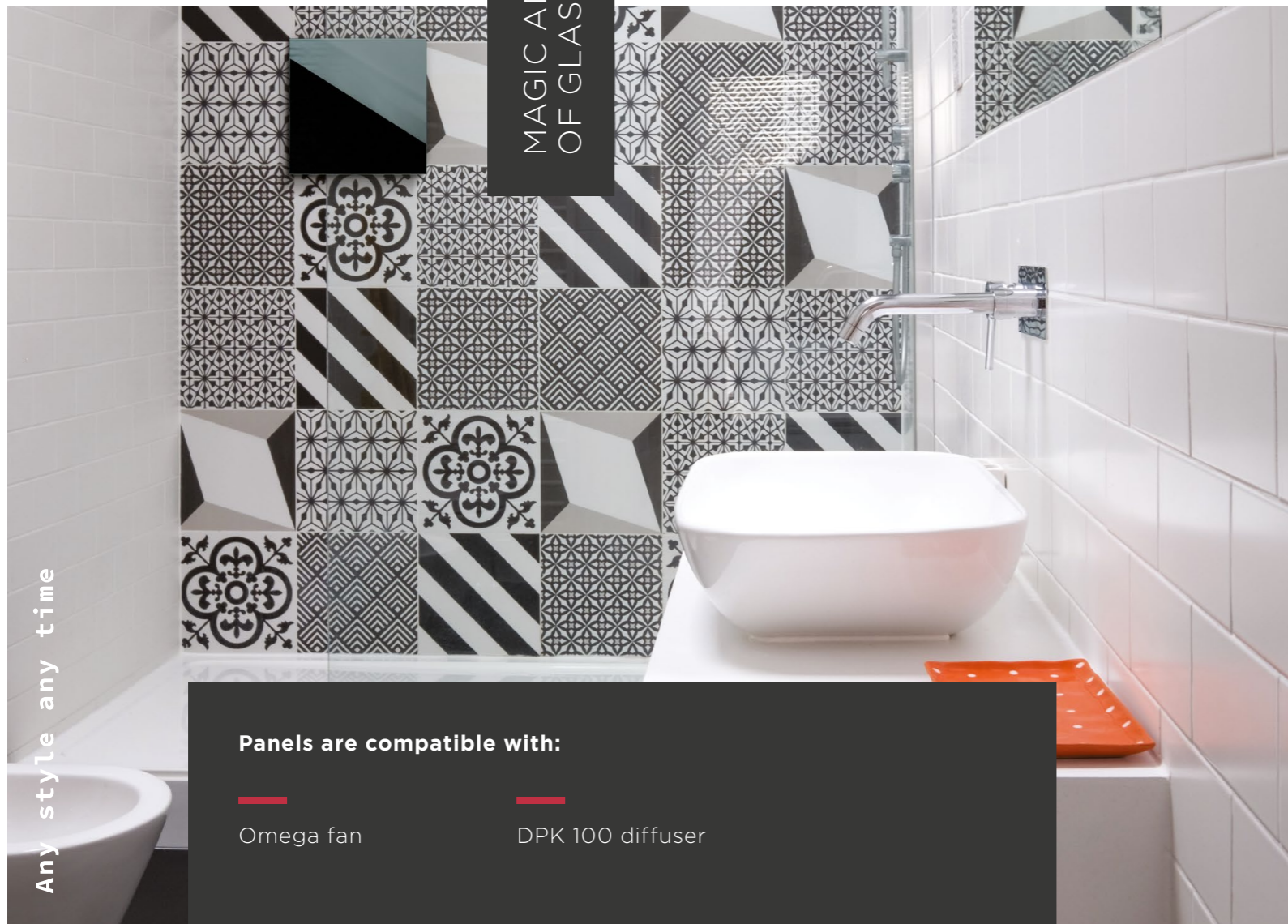

Any style any time

Panels are compatible with:



Omega fan



DPK 100 diffuser

DECORATIVE PANELS OF NATURAL GLASS

Environmental friendliness, practicality and aesthetics are combined in the new decorative panels made of natural glass

The grille together with the panel is securely fixed to the fan, which prevents glass from falling even in case of improper installation



Glas



Glas Red







Glas Black

GENERAL COMPATIBILITY CHART

GENERAL COMPATIBILITY CHART

GENERAL COMPATIBILITY CHART

	DP 180 Plan	DP 180 Plan Red	DP 180 Plan Cosmos Black	DP 180 Platinum	DP 180 Bavaria	DP 180 Hi-Fi	DP 180 Moon	DP 180 Shield
Omega 100 	•	•	•	•	•	•	•	•
Omega 125 	•	•	•	•	•	•	•	•
Decor FB 140x140 s 	•	•	•	•	•	•	•	•
DPK 100 	•	•	•	•	•	•	•	•

DP 180 Chrome	DP 180 High-Tech	DPA 100/180 Glas	DPA 100/180 Glas Red	DPA 100/180 Glas Black	DPO 100/180 Glas	DPO 100/180 Glas Red	DPO 100/180 Glas Black	DPO 125/180 Glas	DPO 125/180 Glas Red	DPO 125/180 Glas Black
•	•				•	•	•			
•	•							•	•	•
•	•									
•	•	•	•	•						



Blauberg Ventilatoren GmbH
Aidenbachstr. 52
D-81379 Munich

info@blaubergventilatoren.de

www.blaubergventilatoren.de

Technical changes reserved.
Illustrations and texts are non-binding.

02/2020

