

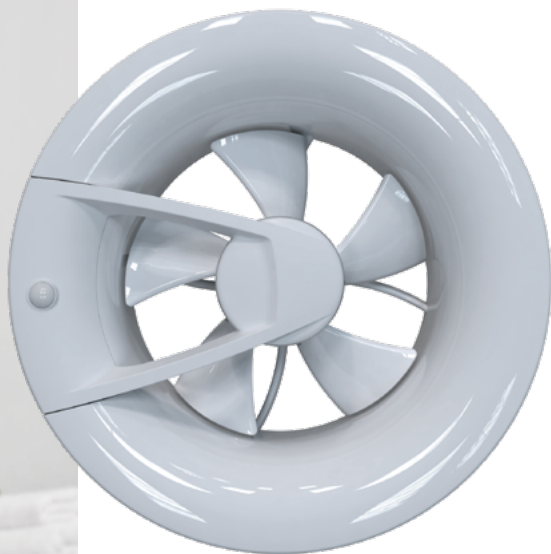

 **BLAUBERG**



 **SUPREME**

AXIAL FAN
User's manual

EN

CONTENTS

Delivery set.....	8
Brief description	8
Operation guidelines	8
Fan modifications.....	9
Fan control.....	10
Installation.....	16
Technical maintenance.....	21
Troubleshooting.....	22
Storage and transportation regulations.....	22
Manufacturer's warranty	23

This user's manual is a main operating document intended for technical, maintenance, and operating staff.

The manual contains information about purpose, technical details, operating principle, design, and installation of the O2 unit and all its modifications.

Technical and maintenance staff must have theoretical and practical training in the field of ventilation systems and should be able to work in accordance with workplace safety rules as well as construction norms and standards applicable in the territory of the country.



**READ THE USER'S MANUAL CAREFULLY BEFORE PROCEEDING WITH INSTALLATION WORKS.
COMPLIANCE WITH THE MANUAL REQUIREMENTS ENSURES RELIABLE OPERATION AND LONG
SERVICE LIFE OF THE UNIT. KEEP THE USER'S MANUAL AVAILABLE AS LONG AS YOU USE THE UNIT.
YOU MAY NEED TO REREAD THE INFORMATION ON THE PRODUCT SERVICING.**

This unit is not intended for use by persons (including children) with reduced physical, sensory or mental capabilities, or lack of experience and knowledge, unless they have been given supervision or instruction concerning use of the unit by a person responsible for their safety.

Children should be supervised to ensure that they do not play with the unit.

This appliance can be used by children aged from 8 years and above and persons with reduced physical, sensory or mental capabilities or lack of experience and knowledge if they have been given supervision or instruction concerning use of the appliance in a safe way and understand the hazards involved.

Cleaning and user maintenance shall not be done by children without supervision.

Children shall not play with the appliance.

Precautions must be taken to avoid the back-flow of gases into the room from the open flue of gas or other fuel-burning appliances.

The appliance may adversely affect the safe operation of appliances burning gas or other fuels (including those in other rooms) due to back flow of combustion gases. These gases can potentially result in carbon monoxide poisoning. After installation of the unit the operation of flued gas appliances should be tested by a competent person to ensure that back flow of combustion gases does not occur.

Connection to the mains must be made through a disconnecting device, which is integrated into the fixed wiring system in accordance with the wiring rules for design of electrical units, and has a contact separation in all poles that allows for full disconnection under overvoltage category III conditions.

Ensure that the unit is switched off from the supply mains before removing the guard.

All operations described in this manual must be performed by qualified personnel only, properly trained and qualified to install, make electrical connections and maintain ventilation units.

Do not attempt to install the product, connect it to the mains, or perform maintenance yourself.

This is unsafe and impossible without special knowledge.

Disconnect the power supply prior to any operations with the unit.

All user's manual requirements as well as the provisions of all the applicable local and national construction, electrical, and technical norms and standards must be observed when installing and operating the unit.

Disconnect the unit from the power supply prior to any connection, servicing, maintenance, and repair operations.

Connection of the unit to power mains is allowed by a qualified electrician with a work permit for the electric units up to 1000 V after careful reading of the present user's manual.

Check the unit for any visible damage of the impeller, the casing, and the grille before starting installation. The casing internals must be free of any foreign objects that can damage the impeller blades.

While mounting the unit, avoid compression of the casing!

Deformation of the casing may result in motor jam and excessive noise.

Misuse of the unit and any unauthorised modifications are not allowed.

Do not expose the unit to adverse atmospheric agents (rain, sun, etc.).

Transported air must not contain any dust or other solid impurities, sticky substances, or fibrous materials.

Do not use the unit in a hazardous or explosive environment containing spirits, gasoline, insecticides, etc.

Do not close or block the intake or extract vents in order to ensure the efficient air flow.

Do not sit on the unit and do not put objects on it.

The information in this user's manual was correct at the time of the document's preparation.

The Company reserves the right to modify the technical characteristics, design, or configuration of its products at any time in order to incorporate the latest technological developments.

Never touch the unit with wet or damp hands.

Never touch the unit when barefoot.

BEFORE INSTALLING ADDITIONAL EXTERNAL DEVICES, READ THE RELEVANT USER MANUALS.



**THE PRODUCT MUST BE DISPOSED SEPARATELY AT THE END OF ITS SERVICE LIFE.
DO NOT DISPOSE THE UNIT AS UNSORTED DOMESTIC WASTE.**

DELIVERY SET

Fan	1 pc.
Screws with dowels	3 pcs.
Plastic screwdriver (for O2 models only)	1 pc.
User's manual	1 pc.
Packing box	1 pc.
Mounting template	1 pc.
Ø 100 mm spigot	1 pc.
Ø 125 mm spigot	1 pc.

BRIEF DESCRIPTION

The product is an axial fan for exhaust ventilation of small and medium-sized premises.

OPERATION GUIDELINES

The fan is rated for connection to single-phase AC 100-240 V, 50/60 Hz or DC 12 V power mains. Power supply parameters are stated on the unit packaging and/or the label on the unit casing. Ingress protection rating against access to hazardous parts and water ingress is IP44.

WARNING! The IP rating is indicated for an assembled unit.

The fan is rated for operation at ambient temperatures ranging from +1 °C to +40 °C.

WARNING! Do not operate the fan outside the specified temperature range.

The unit is rated as a Class II (100-240 V, 50 Hz) or Class III (12 V) electrical appliance and requires no grounding.

Overall dimensions

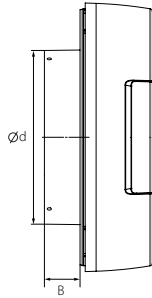
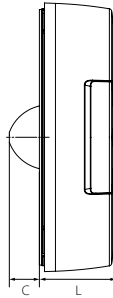
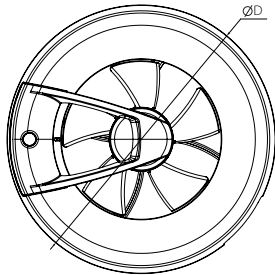

	Dimensions [mm]				
	Ø d	Ø D	C	L	B
O2	100	193	22	55	26
	125				

FAN MODIFICATIONS

Model	Functions					
	Humidity sensor	Motion sensor	Light sensor	Air quality sensor	Temperature sensor	Wi-Fi
O2	+	+	+	-	+	-
O2 Supreme	+	+	+	+	+	+

FAN CONTROL

The **O2** unit is controlled using a multi-position switch.

Main operating modes

- By default, the fan either runs continuously at low speed or does not rotate, depending on the operating mode selected.
- If one or more sensors are triggered, the fan switches to the speed set for the selected fan mode and runs until the sensor signal disappears. After the sensor signal has disappeared, the fan continues to run at high speed for another 15 minutes and then returns to the default speed. If the motion or light sensor is triggered, the fan switches to high speed after a delay of 30 seconds to prevent the fan from switching on when the room is briefly visited.

Preset sensor triggering parameters

- The humidity sensor works in automatic mode. It accumulates statistical information on the natural humidity level in the room, and only reacts to sudden changes in the humidity level. Natural humidity variations due to seasonal changes or weather conditions will not trigger the sensor.
- Temperature sensor. Detects changes in room temperature. Actuates when the room temperature reaches 28 °C, and switches off at 24 °C.
- Motion sensor. Sensor responds to movement in the room.
- The light sensor is in automatic mode. It accumulates statistical information about the natural light level in the room and reacts only to sudden changes in light levels. Natural variations in light levels during the day will not trigger the sensor.

The fan has 8 preset operation modes, which are regulated by a multi-position switch.

Mode 1: the fan operates in constant ventilation mode at a speed of 20 m³/h; the motion sensor, light sensor at 60 m³/h and humidity sensor at 90 m³/h are active.

Mode 2: the fan operates in constant ventilation mode at a speed of 40 m³/h; the motion sensor and light sensor are active at 60 m³/h, and humidity sensor at 90 m³/h.

Mode 3: the fan operates in constant ventilation mode at a speed of 40 m³/h; the humidity sensor at maximum speed is active.

Mode 4: the fan operates in constant ventilation mode at a speed of 60 m³/h; the humidity sensor at maximum speed is active.

Mode 5: the fan is in standby mode; it is started by a signal from the motion sensor and the light sensor at a speed of 60 m³/h, as well as from the humidity sensor at a speed of 90 m³/h.

Mode 6: the fan operates in the interval ventilation mode: the fan turns on for 30 minutes every 12 hours at a speed of 20 m³/h; the motion sensor and light sensor are active at 60 m³/h, and the humidity sensor at 90 m³/h.

Mode 7: the fan is in standby mode; the temperature sensor activated at 90 m³/h; the fan starts at 28 °C and stops at 24 °C.

Mode 8: the fan is in standby mode; it starts on a signal from the humidity sensor at a maximum speed.

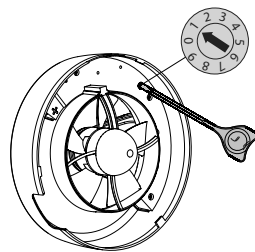

The **O2 Supreme** fan is controlled via an app on the mobile device.

[Blauberg Home – App Store](#)



[Blauberg Home – Play Market](#)



To start using the fan, connect to it as a Wi-Fi access point with the name (FAN: + 16 character ID number) indicated on the control board and on the fan casing.

The password for the Wi-Fi access point is: 11111111.

In the application, you can configure the fan to connect via a home Wi-Fi network and via a cloud server.

Wi-Fi technical data

Standard	IEEE 802.11b/g/n
Frequency band [GHz]	2.4
Transmission power [mW] (dBm)	100(+20)
Network	DHCP
WLAN safety	WPA, WPA2

To recover the Wi-Fi password or connect to a fan to change settings, the **Setup Mode** is provided. To activate the mode, it is necessary to power off fan for not less than 3 second and to power on the device for not more than 2 seconds. Do this three times with the switch on the casing, until the LED under the lens starts blinking blue.

WARNING! Use an external DC power switch for 12 V power supply.

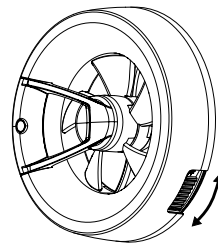

Main modes

24 Hours: The fan runs continuously at the selected speed: 20, 40 or 60 m³/h.

When the sensors are triggered, the fan switches to the speed selected in the application when configuring the corresponding sensor.

Interval ventilation: this mode is only available when the 24 Hours mode is off. When the interval ventilation mode is activated, if no sensor is activated during 24 hours, the fan is switched on for 30 minutes every 12 hours at the speed selected in the application: 20, 40 or 60 m³/h.

Boost: The fan runs at maximum speed for the duration of the turn-off delay timer. Do not disturb: this function allows you to set a time interval during which the fan will not respond to sensors.

Sensors

Humidity sensor: the fan has a built-in humidity sensor with the following operating modes:

- Manual mode allows you to set the humidity threshold in the range from 40% to 80%. If this threshold is exceeded, the fan switches to the set speed of 60, 90 or maximum.
- Auto - intelligent humidity control. This mode provides for changing the threshold value of humidity in automatic mode. The fan independently selects the optimal humidity threshold for the room in which it is installed.

Motion sensor: when the motion sensor is triggered, the fan switches to the speed selected in the application 40, 60, 90 m³/h or maximum. When there is no more motion detected, the turn-off delay timer is activated. At the end of the turn-off delay timer countdown, the fan returns to the previous operating mode.

Light sensor: the light sensor works in automatic mode. It accumulates statistical information about the natural light level in the room and reacts only to sudden changes in light levels. Natural changes in light levels during the day do not trigger the sensor. When the light sensor is triggered, the 30 s turn-on delay timer is activated, after its countdown the fan switches to the speed selected in the application 40, 60, 90 or maximum. If the sensor detects an insufficient light level, the fan switches to the previous mode after the turn-off delay timer counts down.

Air quality sensor:

- Manual mode allows you to set the air quality sensor threshold based on the air quality index in the range from 50 to 250 units. For an explanation of the air quality index values, see in the table. If the level of air pollution exceeds the set level, the fan switches to the speed selected in the application 60, 90 or maximum.
- Auto - intelligent air quality control. This mode allows you to change the air quality threshold automatically. The fan automatically determines the optimal threshold for the air quality sensor and reacts only to sudden changes in the level of air quality in the room.

Temperature sensor: the temperature and speed can be configured in the application. When the selected temperature is reached, the fan switches to the speed configured in the application.

Timers:

- The turn-off delay timer is configured in the application and is designed to keep the fan running for 5, 15, 30, 60 minutes when a sensor is triggered or the Boost mode is turned on.
- The turn-on delay timer is fixed and set to 30 s. Its countdown is activated when the light sensor is triggered to prevent the fan from turning on during short visits to the premises.

Index for air quality classification (IAQ) on levels of volatile organic compounds in air and its colour coding

IAQ Index	Air quality	Influence (long term)	Recommended action
0—50	Excellent	Fresh air; best for well-being	No action required
51—100	Good	Does not irritate mucous or respiratory passages and does not affect well-being	No action required
101—150	Mild contamination	May cause a reduction in well-being	Ventilation is recommended
151—200	Medium contamination	More significant mucous membrane and respiratory tract irritation possible	Increase ventilation with clean air
201—250	Strong contamination	Exposure may cause effects such as headache	Optimize ventilation
251—350	Very heavy contamination	More serious health problems possible	Contamination should be identified if this level is reached even without people present; increase ventilation and reduce attendance
> 351	Extreme contamination	Headaches possible, additional neurotoxic effects	Contamination should be identified, avoid presence in the room and ventilate as much as possible

INSTALLATION

The fan can be installed on the ceiling or on the wall, with air discharge into a round air duct of suitable diameter. A fan with direct air discharge upwards must not be installed.

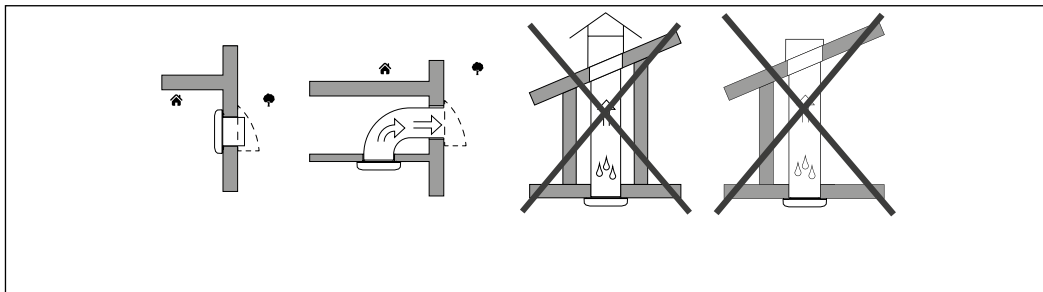

The unit can be installed in bathroom zone 1 (except for the power cable from above), provided that the installation and wiring are in accordance with IEC 60364-7-701 (current version) and in accordance with the national standards of the country of installation.

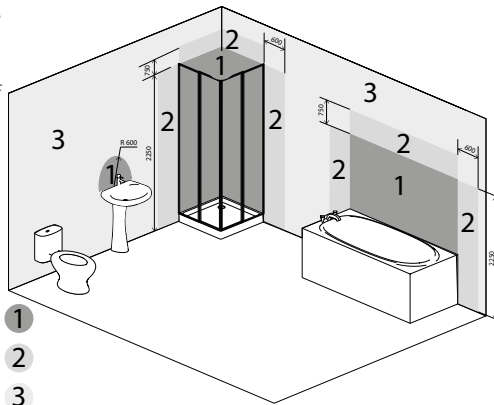

Fan installation sequence:

1. Cut off power supply to the unit and make sure that the electricity is switched off.

For 12 V power supply, install an external DC power switch (not included in the delivery set).

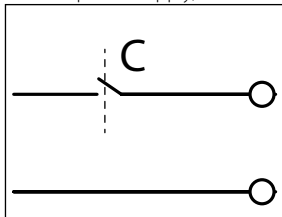

2. Run the power cable to the vent hole. The power cable can be routed on top or bottom of the fan or on top of the fan if the power cable is routed through the wall.

Warning! The top mounting method does not allow installing the fan in bathroom zone 1.

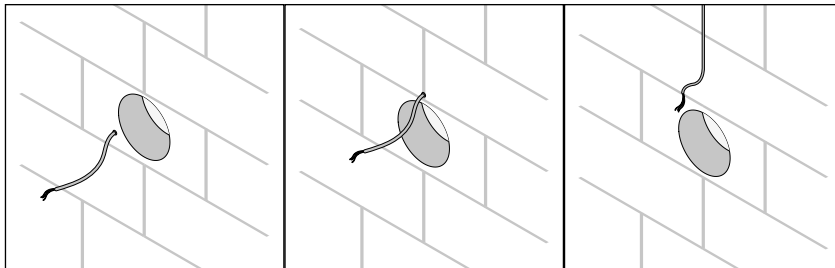

3. Remove the front panel from the fan and the cover.

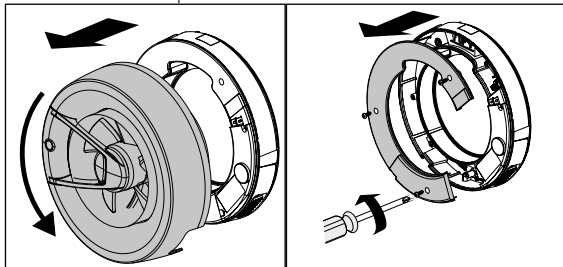

To lead the cable from above, you need to make a hole in the upper part of the front panel of the fan. To mark the place of cutting, use the template. The fan casing has a smaller thickness where the template needs to be attached.

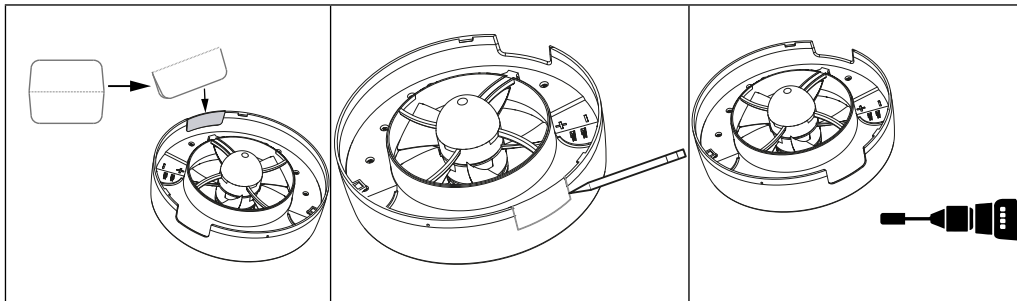

WARNING! Use a power tool with an abrasive attachment or a suitable hand tool to cut the hole.

4. Use the template to mark and drill the holes for the fan mounting, install the fan.

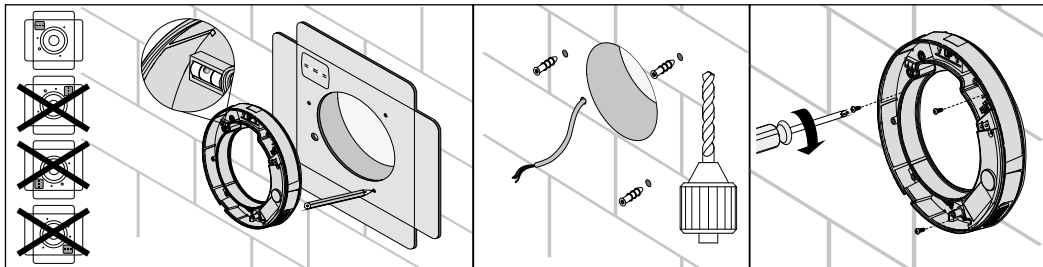

5. Run the power supply cable through the cable gland in the selected way and connect the fan to the power mains as shown in the wiring diagram.

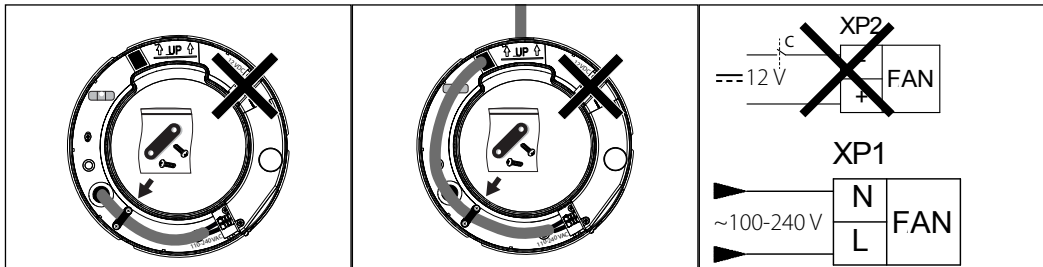

Remove the plugs before connecting to the XP2 connector.



WARNING!
Connect power supply to the XP1 or XP2 connector.
Do not connect two power supplies at the same time.

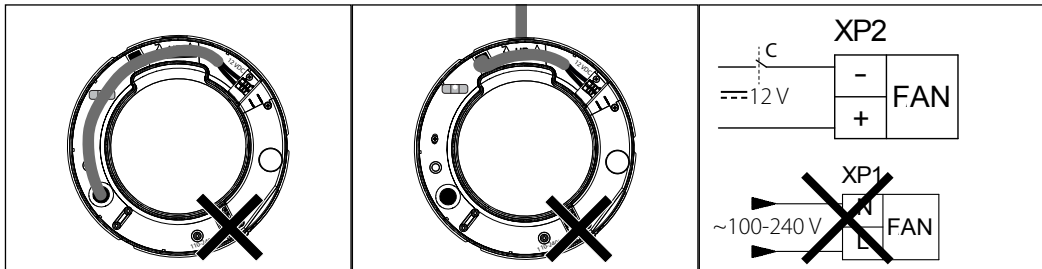

6. Install the cover and the front panel back on the fan casing.

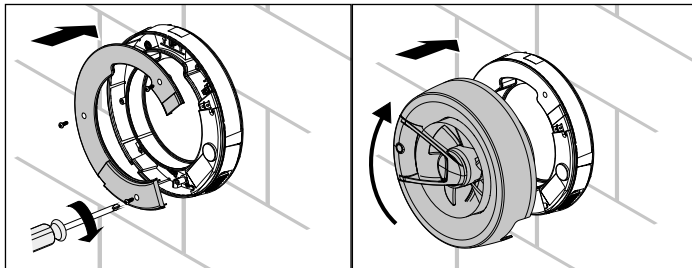

Connect the power supply to the fan.

TECHNICAL MAINTENANCE

The fan maintenance periodicity is at least once per 6 months.

Maintenance steps:

- Disconnect the fan from power supply and make sure electricity has been turned off.
- Remove the front panel, wipe the fan with a dry cloth or a brush.
- Install the front panel on the fan.
- Connect power supply to the fan.

WARNING! Do not allow water or liquid come into contact with electric components!

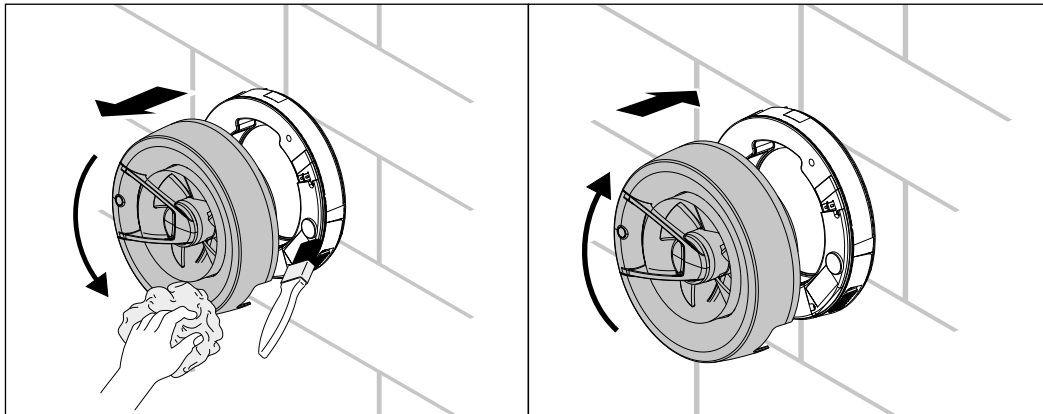

TROUBLESHOOTING

Problem	Possible reasons	Troubleshooting
When the unit is connected to power mains, the fan does not rotate and does not respond to any controls.	No power supply.	Make sure the power supply line is connected correctly, otherwise troubleshoot a connection error.
	Internal connection fault.	Contact the Seller.
Low air flow.	The ventilation system is clogged.	Clean the ventilation system.
Increased noise, vibration.	The impeller is clogged.	Clean the impeller.
	The fan is not secured well or is not mounted properly.	Troubleshoot the installation error.
	The ventilation system is clogged.	Clean the ventilation system.

STORAGE AND TRANSPORTATION REGULATIONS

- Store the unit in the manufacturer's original packaging box in a dry closed ventilated premise with temperature range from +5 °C to + 40 °C and relative humidity up to 70 %.
- Storage environment must not contain aggressive vapors and chemical mixtures provoking corrosion, insulation, and sealing deformation.
- Use suitable hoist machinery for handling and storage operations to prevent possible damage to the unit.
- Follow the handling requirements applicable for the particular type of cargo.
- The unit can be carried in the original packaging by any mode of transport provided proper protection against precipitation and mechanical damage. The unit must be transported only in the working position.
- Avoid sharp blows, scratches, or rough handling during loading and unloading.
- Prior to the initial power-up after transportation at low temperatures, allow the unit to warm up at operating temperature for at least 3-4 hours.

MANUFACTURER'S WARRANTY

The product is in compliance with EU norms and standards on low voltage guidelines and electromagnetic compatibility. We hereby declare that the product complies with the provisions of Electromagnetic Compatibility (EMC) Directive 2014/30/EU of the European Parliament and of the Council, Low Voltage Directive (LVD) 2014/35/EU of the European Parliament and of the Council and CE-marking Council Directive 93/68/EEC. This certificate is issued following test carried out on samples of the product referred to above.

The manufacturer hereby warrants normal operation of the unit for 60 months after the retail sale date provided the user's observance of the transportation, storage, installation, and operation regulations. Should any malfunctions occur in the course of the unit operation through the Manufacturer's fault during the guaranteed period of operation, the user is entitled to get all the faults eliminated by the manufacturer by means of warranty repair at the factory free of charge. The warranty repair includes work specific to elimination of faults in the unit operation to ensure its intended use by the user within the guaranteed period of operation. The faults are eliminated by means of replacement or repair of the unit components or a specific part of such unit component.

The warranty repair does not include:

- routine technical maintenance
- unit installation/dismantling
- unit setup

To benefit from warranty repair, the user must provide the unit, the user's manual with the purchase date stamp, and the payment paperwork certifying the purchase. The unit model must comply with the one stated in the user's manual. Contact the Seller for warranty service.

The manufacturer's warranty does not apply to the following cases:

- User's failure to submit the unit with the entire delivery package as stated in the user's manual including submission with missing component parts previously dismantled by the user.
- Mismatch of the unit model and the brand name with the information stated on the unit packaging and in the user's manual.
- User's failure to ensure timely technical maintenance of the unit.
- External damage to the unit casing (excluding external modifications as required for installation) and internal components caused by the user.
- Redesign or engineering changes to the unit.

- Replacement and use of any assemblies, parts and components not approved by the manufacturer.
- Unit misuse.
- Violation of the unit installation regulations by the user.
- Violation of the unit control regulations by the user.
- Unit connection to power mains with a voltage different from the one stated in the user's manual.
- Unit breakdown due to voltage surges in power mains.
- Discretionary repair of the unit by the user.
- Unit repair by any persons without the manufacturer's authorization.
- Expiration of the unit warranty period.
- Violation of the unit transportation regulations by the user.
- Violation of the unit storage regulations by the user.
- Wrongful actions against the unit committed by third parties.
- Unit breakdown due to circumstances of insuperable force (fire, flood, earthquake, war, hostilities of any kind, blockades).
- Missing seals if provided by the user's manual.
- Failure to submit the user's manual with the unit purchase date stamp.
- Missing payment paperwork certifying the unit purchase.



FOLLOWING THE REGULATIONS STIPULATED HEREIN WILL ENSURE A LONG AND TROUBLE-FREE OPERATION OF THE UNIT



USER'S WARRANTY CLAIMS SHALL BE SUBJECT TO REVIEW ONLY UPON PRESENTATION OF THE UNIT, THE PAYMENT DOCUMENT AND THE USER'S MANUAL WITH THE PURCHASE DATE STAMP

Quality Inspector's Stamp

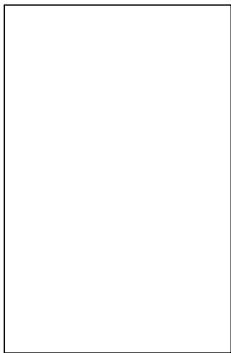

Sold by
(name and stamp of the seller)

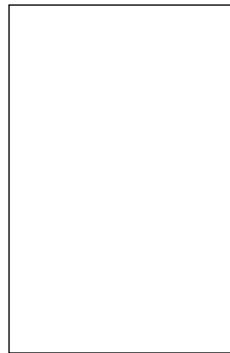

Manufacture Date

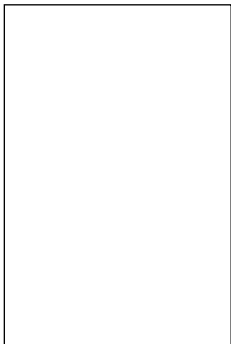

Purchase Date

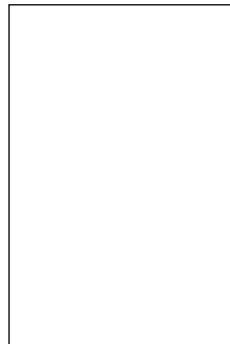



blaubergventilatoren.de

B255EN-02

