



DESCRIPTION

The sensor thyristor speed controller SGS E1/SGS E2.5 is designed for output power of ventilation units and domestic fans as well as their turning on and off. The speed controller is equipped with a sensitive sensor panel made of hardened glass, with the button  and two buttons for speed control from minimum () to maximum value ()

TECHNICAL DATA

	SGS E1	SGS E2.5
Power supply voltage [V]	110-240/50	
Maximum load current [A]	1	2.5
Cable cross section [mm ²]	from 0.35 up to 1	from 0.75 up to 1
Temperature range [°C]	from -10 up to +45	
Humidity range [%]	5-80 (no condensation)	
Service life	100 000 switching operations	
Ingress Protection Rating	IP30	
Weight [g]	138	

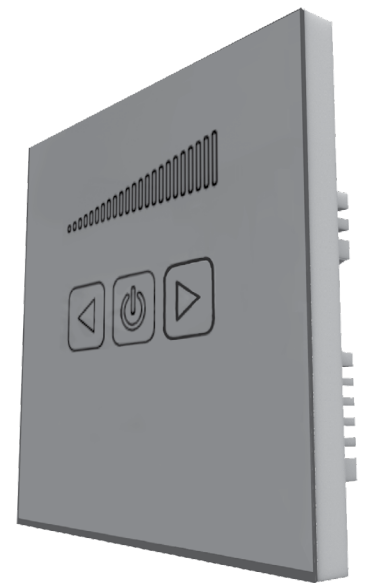

MOUNTING

WARNING! Make sure that the speed controller is not damaged. Do not operate a damaged speed controller! Do not install the speed controller on an uneven surface! Do not apply excessive forces to avoid the product deformation.

Mounting sequence of the sensor speed controller:

- Unfasten gently the front panel latches of the speed controller.
- Remove the front panel.
- Route the cable in the wall to the panel mounting place.
- Attach the back panel to the wall or in the mounting box through the mounting holes.
- Install the front panel on the latches.

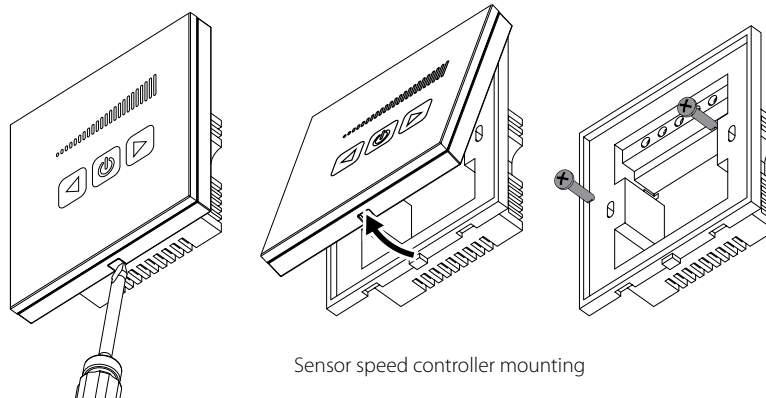

OVERALL AND CONNECTING DIMENSIONS

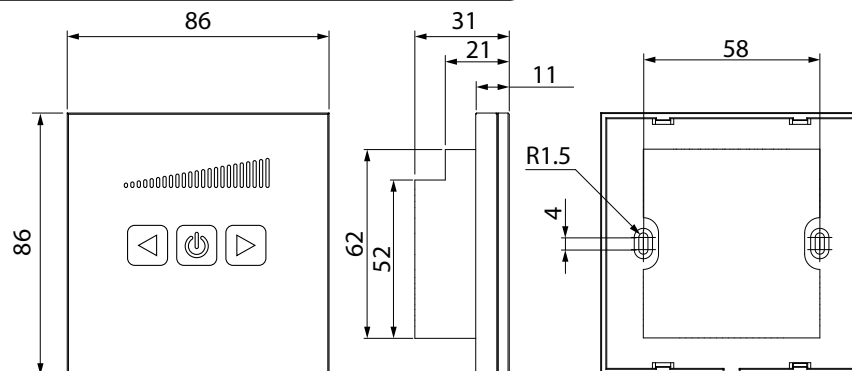

WIRING DIAGRAM

WARNING! Disconnect the speed controller from power supply prior to any maintenance operations.

All work related to mounting, amendments, modification and maintenance may only be carried out by qualified personnel with work permit for electric operations.

There are two modifications of the speed controller casing. The wiring diagrams (depending on the casing modification) are provided below.

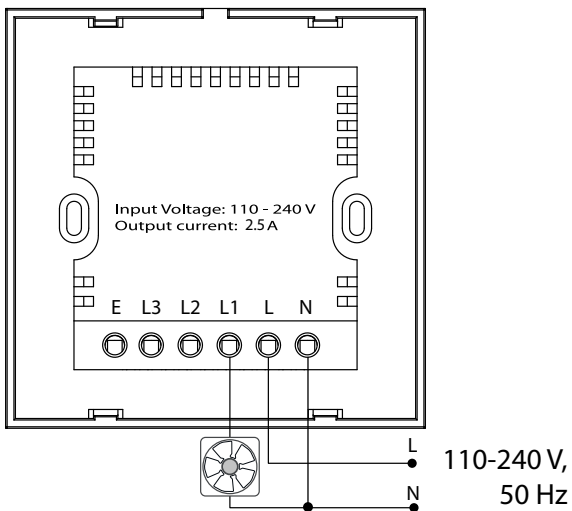

Wiring diagram (SGS E1 and SGS E2.5)

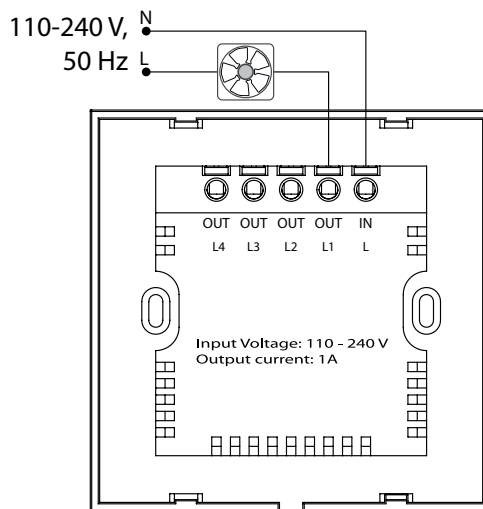

Wiring diagram (only for SGS E1)

CONTROL

Operation	Key
When connected to power mains the button has blue soft light	
To turn ventilation equipment on press the button	
To turn ventilation equipment off press the button	
To decrease ventilation equipment speed press the button	
To increase ventilation equipment speed press the button	
Minimum speed setting:	
1. Press and hold the button for about 5 seconds until the indicator shows about 50 % of the operating speed range (that helps distinguish the setup mode from the operating mode). The ventilation equipment will operate with maximum speed	
2. Set minimum speed:	
To set speed up press the button	
To set speed down press the button	
The set speed level is displayed on the LED indicator	
To save set point press the button	
To turn the fan on and to activate its operation in set mode press the button	
The minimum speed set point will be saved	

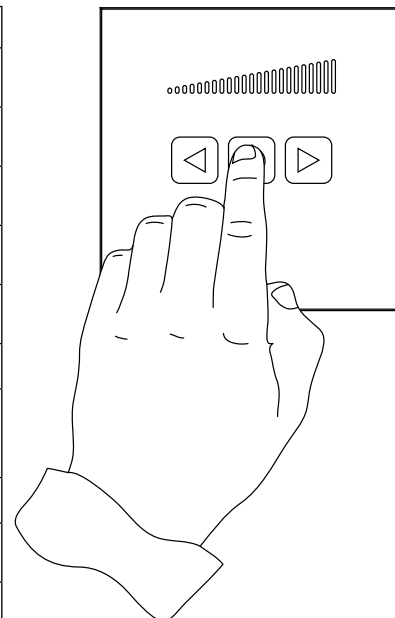

Speed controller operation

Every time you enter the set up mode the previous minimum fan speed is set as 100 % of the total capacity by default.

WARRANTY

Unit Type	Sensor speed controller
Model	SGS E ____
Serial Number	
Manufacture Date	
Purchase Date	
Warranty Period	
Seller	

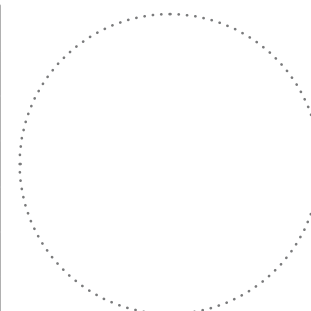

Seller's Stamp