

# KOMFORT EC SB

## Heat and humidity recovery air handling units

### Features

- Air handling units for efficient energy saving supply and exhaust ventilation in flats, houses, cottages and other premises.
- Heat and humidity recovery minimizes ventilation heat losses during cold season and reduces air conditioner load during hot season.
- Controllable air exchange for creating the best suitable indoor microclimate.
- Compatible with round Ø 125, 160 or 200 mm air ducts.



**Air flow:**  
up to 692 m<sup>3</sup>/h  
192 l/s



**Heat recovery efficiency:**  
up to 98 %



### Design

- The casing is made of double-skinned polymer-coated steel panels, internally filled with 20, 30, 40 mm (depending on the unit model) mineral wool layer for heat- and sound-insulation.
- The unit is equipped with a hinged service panel to enable convenient access for maintenance or repair operations.
- The spigots are located at the top of the unit and are equipped with rubber seals for airtight connection to the air ducts.

### Fans

- The units are equipped with high-efficient EC motors with an external rotor and a centrifugal impeller with backward curved blades.
- EC motors have the best power consumption to air capacity ratio and meet the latest demands concerning energy saving and high-efficient ventilation.
- EC motors are featured with high performance, low noise level and optimum control across the entire speed range.
- The impellers are dynamically balanced.

### Air filtration

- The built-in F7 filter provides efficient supply air filtration. The G4 filter is used for extract air cleaning.
- In the **KOMFORT EC SB(E) 250** units, the supply air is cleaned by the G4 filter (F7 filter optionally available).

### Bypass

- The **KOMFORT EC SB(-E)** units are equipped with a bypass for ventilation (air cooling by the cool air from outside).

HEAT RECOVERY AIR HANDLING UNITS

### KOMFORT EC SB

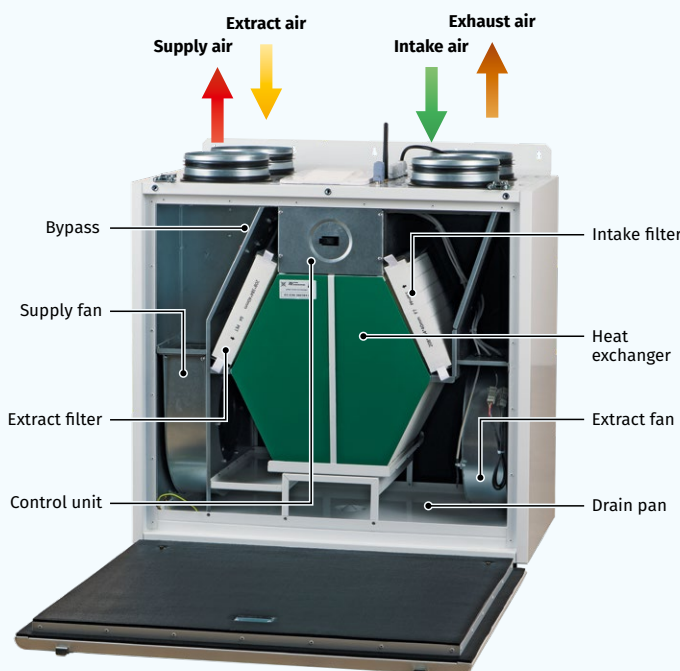

### KOMFORT EC SB(E) 250(-E)

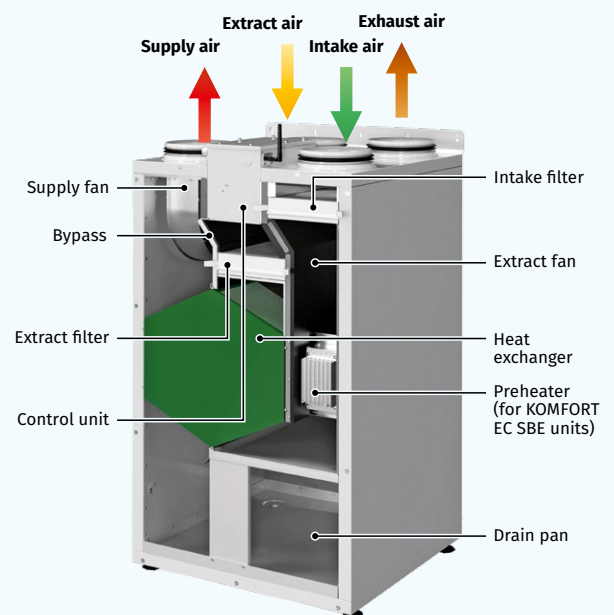

### Heat recovery

The **KOMFORT EC S(B)** unit is equipped with a plate counter-flow polystyrene heat exchanger for heat recovery. The unit condensate is collected and drained to the drain pan under the heat exchanger.



The **KOMFORT EC S(B)-E** unit is equipped with an enthalpy plate counter-flow heat exchanger for energy (heat and humidity) recovery. Due to humidity recovery condensate is not generated in the enthalpy heat exchanger.



- The air flows are completely separated in the heat exchanger. Thus smells and contaminants are not transferred from the extract air to the supply air.
- Heat recovery is based on heat and/or humidity transfer through the heat exchanger plates. In the cold season supply air is heated in the heat exchanger by transferring the heat energy of warm and humid extract air to the cold fresh air. Heat recovery minimizes ventilation heat losses and heating costs respectively.
- In the warm season the heat exchanger performs reverse and intake air is cooled in the heat exchanger by the cool extract air. That reduces operation load on air conditioners and saves electricity.
- When the indoor and outdoor temperature difference is insignificant, heat recovery is not reasonable. In this case the heat exchanger can be temporary replaced with a summer block for the warm season (available as a specially ordered accessory).

### Mounting

- The units are designed for wall or floor mounting.
- Universal casing design provides either left-handed or right-handed unit installation.

### Control and automation

- The **KOMFORT EC S(B)-E S21** units are equipped with an integrated automation system. The remote control panel is not included in the delivery set (available separately).
- The S21 controller allows to integrate the unit into the **Smart Home** system or **BMS (Building Management System)**.
- The unit can be controlled by the **Blauberg AHU** mobile application via Wi-Fi.



Download the **Blauberg AHU** app for Android







Download the **Blauberg AHU** app for iOS



- The **KOMFORT EC S(B)-E S14** units have an integrated automation system with a wall-mounted control panel S14 with a LED indication.

### Automation functions

Functions	KOMFORT EC S(B)-E S21	KOMFORT EC S(B)-E S14
Unit control via Wi-Fi using a mobile application	+	-
Unit control via a wired remote control panel	S22 control panel (option) 	S14 control panel 
Unit control via a wireless remote control panel	S22 Wi-Fi control panel (option) 	-
Unit control via a wired remote LCD control panel	S25 control panel (option) 	-
BMS (Building Management System)	RS-485	-
	Wi-Fi	-
	Ethernet	-
	MODBUS (RTU, TCP)	-
Blauberg Cloud Server service	+	-
Speed selection	+	+
Filter replacement indication	by filter timer	by filter timer
	by filter clogging differential pressure switch (KOMFORT EC SB 550)	-
Alarm indication	full alarm description in the mobile application	LED alarm indication
Week-scheduled operation	+	-
Bypass	automatic	-
	manual	manual
Timer	+	-
Boost mode	+	-
Fireplace mode	+	-
Freeze protection	through cyclic stops of the supply fan	through cyclic stops of the supply fan
	through preheating (option)	-
Reheater connection	option	-
Cooler connection	option	-
Minimum supply air temperature control	+	-
Humidity control	option	option
CO <sub>2</sub> control	option	option
VOC control	option	-
PM2.5 control	option	-
Fire alarm sensor connection	option	option

Option: function is available when purchasing the appropriate accessory (see the "Accessories" section).

### Designation key

Series	Motor type	Spigot modification	Bypass	Heater type	Rated air flow, [m <sup>3</sup> /h]	Heat exchanger type	Service side	Control
KOMFORT	EC: electronically commutated motor	S: vertical spigot orientation	-: no bypass B: with a bypass	-: no heater E: integrated electric preheater	160; 250; 350; 550	-: heat recovery -E: energy recovery	L: left R: right (for KOMFORT EC SB(E) 250 only)	S21 S14

### Overall dimensions [mm]

Model	∅ D	B	H	L
KOMFORT EC S 160(-E) S14	125	330	550	600
KOMFORT EC SB 160(-E) S21/S14	125	330	580	600
KOMFORT EC SB(E) 250(-E) S21/S14	160	560	970	560
KOMFORT EC SB 350(-E) S21/S14	160	583	675	730
KOMFORT EC SB 550(-E) S21/S14	200	720	675	823

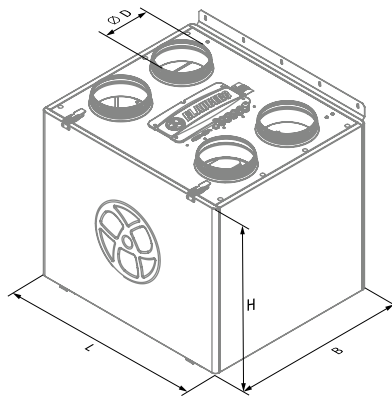

### Technical data

Parameters	KOMFORT EC SB 160 S21 KOMFORT EC SB 160 S14	KOMFORT EC SB 160-E S21 KOMFORT EC SB 160-E S14
Supply voltage [V / 50 (60) Hz]	1~ 230	1~ 230
Power [W]	57	57
Current [A]	0.5	0.5
Maximum air flow [m³/h (l/s)]	200 (56)	200 (56)
Sound pressure level at a distance of 3 m [dBA]	24	24
Transported air temperature [°C]	-25...+40	-25...+40
Casing material	polymer-coated steel	polymer-coated steel
Insulation	20 mm mineral wool	20 mm mineral wool
Extract filter	G4	G4
Supply filter	F7 (option: G4)	F7 (option: G4)
Connected air duct diameter [mm]	125	125
Weight [kg]	36	36
Heat recovery efficiency [%]	85–93	76–92
Heat exchanger type	counter-flow	counter-flow
Heat exchanger material	polystyrene	enthalpy
SEC class	A+	A
ErP	2016, 2018	2016, 2018

### KOMFORT EC S(B) 160(-E)

Sound power level, A-weighted	Total	Octave frequency band [Hz]								LpA 3 m	LpA 1 m
		63	125	250	500	1000	2000	4000	8000		
L <sub>WA</sub> to supply inlet [dBA]	52	28	46	49	41	35	33	36	29		
L <sub>WA</sub> to supply outlet [dBA]	60	32	52	58	47	37	36	41	35		
L <sub>WA</sub> to exhaust inlet [dBA]	51	27	45	49	41	36	32	35	29		
L <sub>WA</sub> to exhaust outlet [dBA]	60	31	50	59	48	36	36	41	32		
L <sub>WA</sub> to environment [dBA]	45	25	41	42	34	31	28	27	22	24	34

Data provided for point 1 of the air flow diagram

Point	Total power of the unit [W]	Sound pressure level at 3 m (1 m) [dBA]
1	57	24 (34)
2	56	23 (33)
3	54	23 (33)
4	28	20 (30)
5	27	20 (30)
6	26	20 (30)
7	14	13 (23)
8	13	13 (23)
9	13	13 (23)

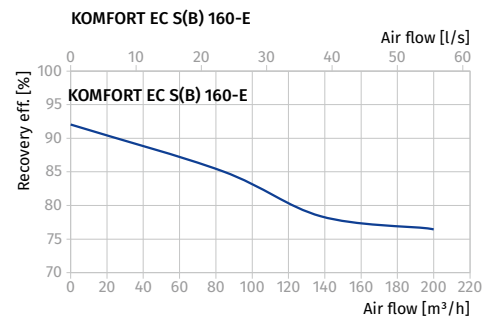
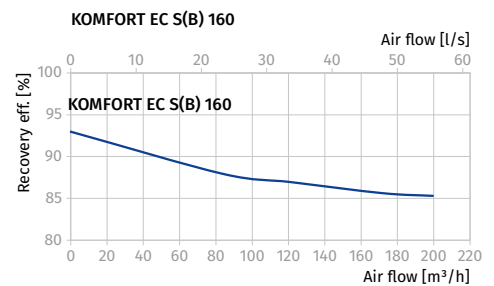
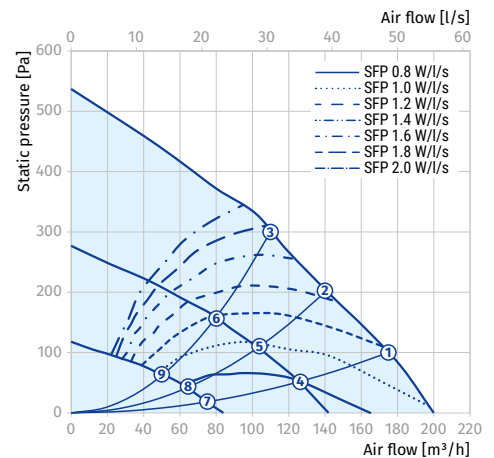

### Calculation of air temperature downstream of the heat exchanger:

$$t = t_{\text{outd}} + k_{\text{hr}} \times (t_{\text{extr}} - t_{\text{outd}}) / 100,$$

where

$t_{\text{outd}}$  – outdoor air temperature [°C]

$t_{\text{extr}}$  – extract air temperature [°C]

$k_{\text{hr}}$  – heat exchanger efficiency (according to the diagram) [%]

Parameters	KOMFORT EC SB 250 S21 KOMFORT EC SB 250 S14	KOMFORT EC SB 250-E S21 KOMFORT EC SB 250-E S14	KOMFORT EC SBE 250 S21	KOMFORT EC SBE 250-E S21
Supply voltage [V / 50 (60) Hz]	1~ 230	1~ 230	1~ 230	1~ 230
Power [W]	180	180	180	180
Current [A]	1.37	1.37	1.37	1.37
Electric heater power [W]	-	-	1400	1400
Electric heater current [A]	-	-	6.09	6.09
Max. unit power with electric heater [W]	180	180	1580	1580
Max. unit current with electric heater [A]	1.37	1.37	7.46	7.46
Maximum air flow [m³/h (l/s)]	390 (108)	390 (108)	390 (108)	390 (108)
Sound pressure level at a distance of 3 m [dBA]	35	35	35	35
Transported air temperature [°C]	-25...+40	-25...+40	-25...+40	-25...+40
Casing material	polymer-coated steel	polymer-coated steel	polymer-coated steel	polymer-coated steel
Insulation	30 mm mineral wool	30 mm mineral wool	30 mm mineral wool	30 mm mineral wool
Extract filter	G4	G4	G4	G4
Supply filter	G4 (option: F7)	G4 (option: F7)	G4 (option: F7)	G4 (option: F7)
Connected air duct diameter [mm]	160	160	160	160
Weight [kg]	66	66	66	66
Heat recovery efficiency [%]	88-95	78-90	88-95	78-90 %
Heat exchanger type	counter-flow	counter-flow	counter-flow	counter-flow
Heat exchanger material	polystyrene	enthalpy	polystyrene	enthalpy
SEC class	A+	A	A+	A
ErP	2016, 2018	2016, 2018	2016, 2018	2016, 2018

**KOMFORT EC SB(E) 250 (-E)**

Sound power level, A-weighted	Total	Octave frequency band [Hz]							LpA 3 m	LpA 1 m
		125	250	500	1000	2000	4000	8000		
L <sub>WA</sub> to supply inlet [dBA]	70	51	55	59	64	65	63	54	49	59
L <sub>WA</sub> to supply outlet [dBA]	68	50	55	59	64	63	58	53	48	58
L <sub>WA</sub> to exhaust inlet [dBA]	76	28	58	66	70	68	69	62	55	65
L <sub>WA</sub> to exhaust outlet [dBA]	67	27	56	65	57	59	54	47	47	57
L <sub>WA</sub> to environment [dBA]	56	24	50	49	47	45	48	45	35	45

Data provided for point 1 of the air flow diagram

Point	Total power of the unit [W]	Sound pressure level at 3 m (1 m) [dBA]
1	180	35 (45)
2	179	35 (45)
3	168	35 (45)
4	63	24 (34)
5	57	24 (34)
6	52	23 (33)
7	15	18 (27)
8	15	17 (27)
9	14	17 (27)

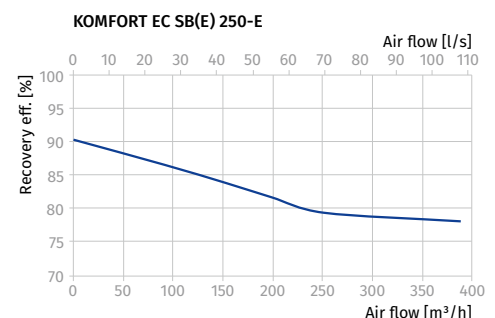
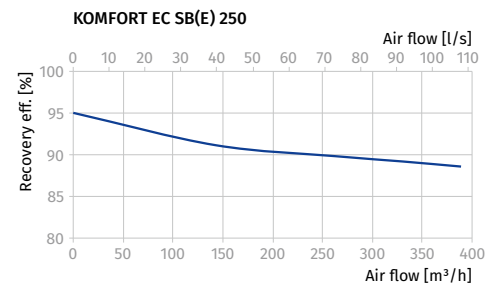
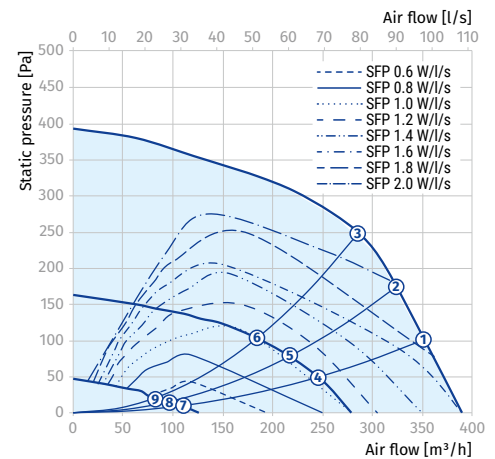

Parameters	KOMFORT EC SB 350 S21 KOMFORT EC SB 350 S14	KOMFORT EC SB 350-E S21 KOMFORT EC SB 350-E S14
Supply voltage [V / 50 (60) Hz]	1~ 230	1~ 230
Power [W]	178	178
Current [A]	1.4	1.4
Maximum air flow [m³/h (l/s)]	450 (125)	450 (125)
Sound pressure level at a distance of 3 m [dBA]	28	28
Transported air temperature [°C]	-25...+40	-25...+40
Casing material	polymer-coated steel	polymer-coated steel
Insulation	40 mm mineral wool	40 mm mineral wool
Extract filter	G4	G4
Supply filter	F7 (option: G4)	F7 (option: G4)
Connected air duct diameter [mm]	160	160
Weight [kg]	64	64
Heat recovery efficiency [%]	85-92	73-91
Heat exchanger type	counter-flow	counter-flow
Heat exchanger material	polystyrene	enthalpy
SEC class	A+	A
ErP	2016, 2018	2016, 2018

**KOMFORT EC SB 350(-E)**

Sound power level, A-weighted	Total	Octave frequency band [Hz]								LpA 3 m	LpA 1 m
		63	125	250	500	1000	2000	4000	8000		
L <sub>WA</sub> to supply inlet [dBA]	56	50	46	53	45	39	34	36	32		
L <sub>WA</sub> to supply outlet [dBA]	64	56	52	63	52	39	38	43	35		
L <sub>WA</sub> to exhaust inlet [dBA]	56	52	46	53	45	38	34	36	31		
L <sub>WA</sub> to exhaust outlet [dBA]	64	58	53	62	51	40	38	42	33		
L <sub>WA</sub> to environment [dBA]	49	45	40	44	38	33	29	27	22	28	38

Data provided for point 1 of the air flow diagram

Point	Total power of the unit [W]	Sound pressure level at 3 m (1 m) [dBA]
1	177	28 (38)
2	175	27 (37)
3	170	27 (37)
4	71	23 (33)
5	71	22 (32)
6	69	22 (32)
7	21	15 (25)
8	21	14 (24)
9	21	14 (24)

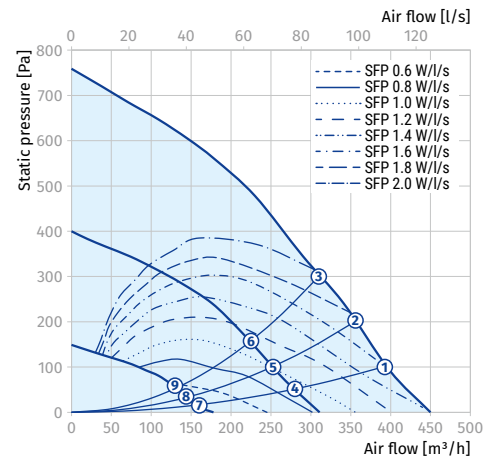

**KOMFORT EC S(B) 350**

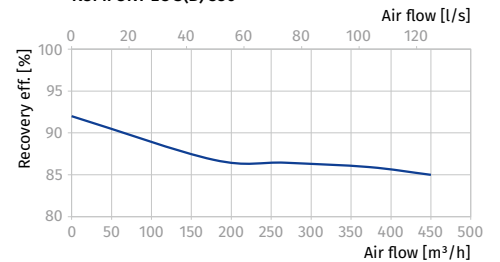

**KOMFORT EC S(B) 350-E**

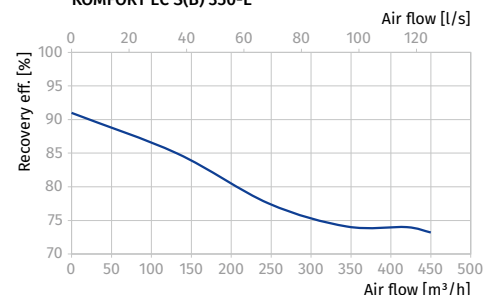

**KOMFORT EC SB 350**

Parameters	KOMFORT EC SB 550 S21 KOMFORT EC SB 550 S14	KOMFORT EC SB 550-E S21 KOMFORT EC SB 550-E S14
Supply voltage [V / 50 (60) Hz]	1~ 230	1~ 230
Power [W]	350	350
Current [A]	2.4	2.4
Maximum air flow [m³/h (l/s)]	692 (192)	692 (192)
Sound pressure level at a distance of 3 m [dBA]	38	38
Transported air temperature [°C]	-25...+40	-25...+40
Casing material	polymer-coated steel	polymer-coated steel
Insulation	40 mm mineral wool	40 mm mineral wool
Extract filter	G4	G4
Supply filter	F7 (option: G4)	F7 (option: G4)
Connected air duct diameter [mm]	200	200
Weight [kg]	82	82
Heat recovery efficiency [%]	85-92	73-91
Heat exchanger type	counter-flow	counter-flow
Heat exchanger material	polystyrene	enthalpy
SEC class	A+	A
ErP	2016, 2018	2016, 2018

**KOMFORT EC SB 550(-E)**

Sound power level, A-weighted	Total	Octave frequency band [Hz]								LpA 3 m	LpA 1 m
		63	125	250	500	1000	2000	4000	8000		
LWA to supply outlet [dBA]	68	53	49	53	63	61	53	78	43		
LWA to exhaust inlet [dBA]	62	44	42	47	49	46	42	36	27		
LWA to environment [dBA]	56	41	37	39	43	45	45	38	35	38	48

Data provided for point 1 of the air flow diagram

Point	Total power of the unit [W]	Sound pressure level at 3 m (1 m) [dBA]
1	345	38 (48)
2	349	36 (45)
3	349	36 (45)
4	131	27 (37)
5	131	27 (37)
6	131	27 (37)
7	22	17 (26)
8	22	17 (27)
9	22	17 (27)

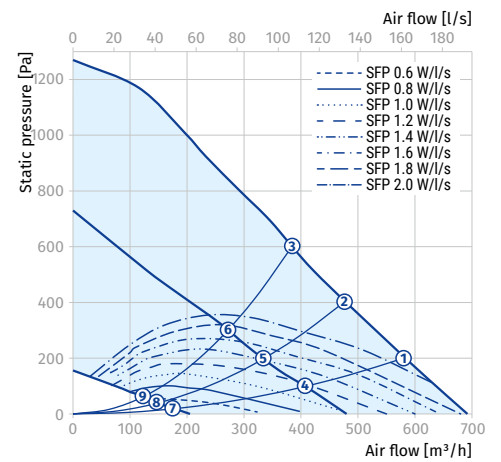



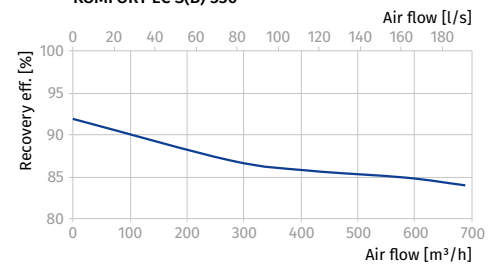



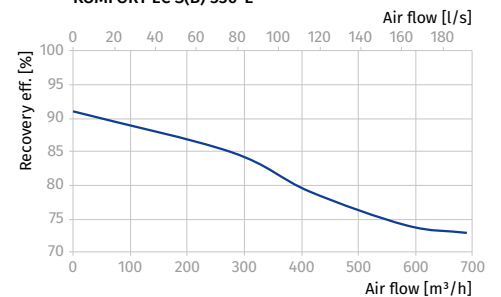







**KOMFORT EC S(B) 550**

















**KOMFORT EC S(B) 550-E**



**Accessories**

		KOMFORT EC SB 160(-E) S21	KOMFORT EC SB 160(-E) S14
G4 panel filter		–	–
G4 panel filter		FP 285x195x10 G4	FP 285x195x10 G4
F7 panel filter		FP 285x195x10 F7	FP 285x195x10 F7
Control panel		S22	–
Wireless control panel		S22 Wi-Fi	–
LCD control panel		S25	–
Humidity sensor		FS2	FS2
CO <sub>2</sub> sensor with indication		CD-1	CD-1
CO <sub>2</sub> sensor		CD-2	CD-2
Humidity sensor		HR-S	HR-S
Electric preheater		EVH 125 S21 V.2	–
Electric reheater		ENH 125 S21 V.2	–
Syphon kit (for the units without an enthalpy heat exchanger)		SFK 20x32	SFK 20x32
Air damper		VKA 125	VKA 125
Electric actuator		TF230	TF230



		KOMFORT EC SB 250(-E) S21	KOMFORT EC SB 250(-E) S14	KOMFORT EC SBE 250(-E) S21
G4 panel filter		FP 500x170x48 G4	FP 500x170x48 G4	FP 500x170x48 G4
G4 panel filter		FP 340x170x48 G4	FP 340x170x48 G4	FP 340x170x48 G4
F7 panel filter		FP 340x170x48 F7	FP 340x170x48 F7	FP 340x170x48 F7
Control panel		S22	-	S22
Wireless control panel		S22 Wi-Fi	-	S22 Wi-Fi
LCD control panel		S25	-	S25
Humidity sensor		FS2	FS2	FS2
CO <sub>2</sub> sensor with indication		CD-1	CD-1	CD-1
CO <sub>2</sub> sensor		CD-2	CD-2	CD-2
Humidity sensor		HR-S	HR-S	HR-S
Electric preheater		-	-	-
Electric reheater		ENH-160 S21 V.2	-	ENH-160 S21 V.2
Syphon kit (for the units without an enthalpy heat exchanger)		SFK 20x32	SFK 20x32	-
Air damper		VKA 160	VKA 160	VKA 160
Electric actuator		TF230	TF230	TF230

		KOMFORT EC SB 350(-E) S21	KOMFORT EC SB 350(-E) S14	KOMFORT EC SB 550(-E) S21	KOMFORT EC SB 550(-E) S14
G4 panel filter		–	–	–	–
G4 panel filter		FP 500x196x40 G4	FP 500x196x40 G4	FP 630x198x40 G4	FP 630x198x40 G4
F7 panel filter		FP 500x196x40 F7	FP 500x196x40 F7	FP 630x198x40 F7	FP 630x198x40 F7
Control panel		S22	–	S22	–
Wireless control panel		S22 Wi-Fi	–	S22 Wi-Fi	–
LCD control panel		S25	–	S25	–
Humidity sensor		FS2	FS2	FS2	FS2
CO <sub>2</sub> sensor with indication		CD-1	CD-1	CD-1	CD-1
CO <sub>2</sub> sensor		CD-2	CD-2	CD-2	CD-2
Humidity sensor		HR-S	HR-S	HR-S	HR-S
Electric preheater		EVH 160 S21 V.2	–	EVH 200 S21 V.2	–
Electric reheater		ENH 160 S21 V.2	–	ENH 200 S21 V.2	–
Syphon kit (for the units without an enthalpy heat exchanger)		SFK 20x32	SFK 20x32	SFK 20x32	SFK 20x32
Air damper		VKA 160	VKA 160	VKA 200	VKA 200
Electric actuator		TF230	TF230	TF230	TF230