

KOMFORT EC DBE

Suspended heat recovery air handling units

Features

- Air handling units for efficient supply and exhaust ventilation in flats, houses, cottages and other buildings.
- For controllable mechanical energy saving ventilation systems.
- Heat recovery minimises ventilation heat losses.
- Control of air exchange for creating comfortable indoor microclimate.
- Compatible with round Ø 160, 200, 250, 315, 400 mm air ducts.



Air flow:
up to 4300 m³/h
1195 l/s



Heat recovery efficiency:
up to 90 %



Design

- The casing is made of double-skinned aluzinc panels, internally filled with 20 mm mineral wool layer for heat and sound insulation.
- The casing has fixing brackets with vibration absorbing connectors for easy installation.
- The spigots for connection to the air ducts are located at the side of the unit and are rubber sealed for airtight connection to the air ducts.
- The service panel ensures easy access to the internals for cleaning, filter replacement and other maintenance operations.

KOMFORT EC DBE... 300/550/900

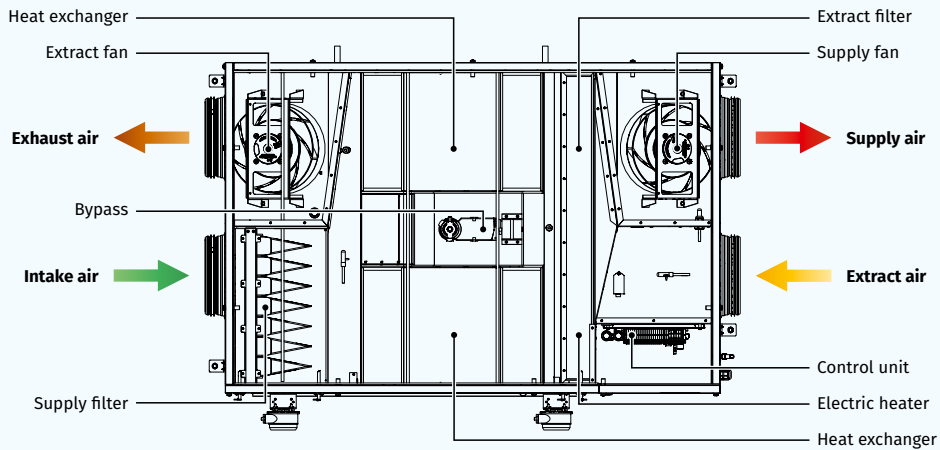

KOMFORT EC DBE... 2000/3000

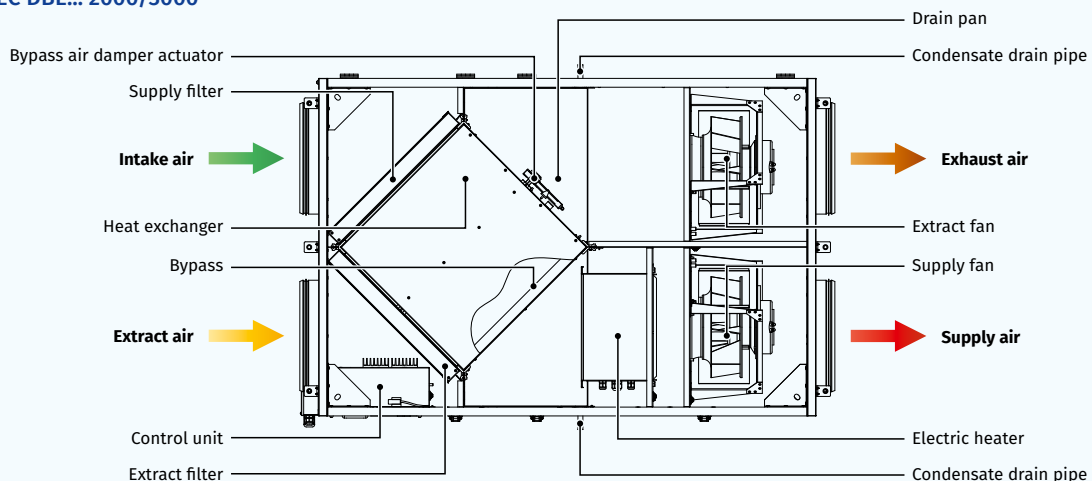

HEAT RECOVERY AIR HANDLING UNITS

Fans

- High-efficient external rotor EC motors and centrifugal impellers with backward curved blades are used for air supply and exhaust.
- EC motors have the best power consumption to air flow ratio and meet the latest demands concerning energy saving and high-efficient ventilation.
- EC motors are featured with high performance, low noise level and totally controllable speed range.
- Dynamically balanced impellers.

Heat recovery

- The **KOMFORT EC DBE 300/550/900** unit is equipped with a plate counter-flow polystyrene heat exchanger for heat recovery. The drain pan located under the heat exchanger is designed for condensate collection and drainage.
- The **KOMFORT EC DBE 2000/3000** unit is equipped with a plate cross-flow aluminum heat exchanger for heat recovery. The drain pan located under the heat exchanger is designed for condensate collection and drainage.
- The **KOMFORT EC DBE...-E 300/550/900** unit is equipped with an enthalpy plate counter-flow heat exchanger for energy (heat and humidity) recovery. Due to humidity recovery condensate is not generated in the enthalpy heat exchanger.



- The air flows are completely separated in the heat exchanger. Thus smells and contaminants are not transferred from the extract air to the supply air.
- Heat recovery is based on heat and/or humidity transfer through the heat exchanger plates. In the cold season supply air is heated in the heat exchanger by transferring the heat energy of warm and humid extract air to the cold fresh air. Heat recovery minimizes ventilation heat losses and heating costs respectively.
- In the warm season the heat exchanger performs reverse and intake air is cooled in the heat exchanger by the cool extract air. That reduces operation load on air conditioners and saves electricity.

Air heater

- The unit is equipped with an electric heater for operation during cold seasons at low outside temperature.
- The integrated electric heater is activated to warm up supply air flow if set indoor air temperature may not be reached by means of heat recovery only.
- Smooth heat output control ensures automatic supply air temperature maintaining.
- Two integrated overheat protection thermostats, one actuated at +60 °C with automatic restart and the other one actuated at +90 °C with manual restart.

Bypass

- The units are equipped with a bypass for summer ventilation (room cooling by cool air from outside) and heat exchanger freeze protection.

Air filtration

- The built-in G4 supply filter and G4 extract filter provide air filtration.
- The F7 supply filter (specially ordered accessory) may be used for efficient supply air filtration.

Mounting

- Ceiling mounting with fixing brackets.
- The correctly mounted unit must provide free condensate collection and drainage as well as good access for servicing and filter replacement.
- Access for servicing and cleaning the filter: from the right or left side panel, depending on the unit modification.

Control and automation

- The units are equipped with an S21 integrated automation system. The remote control panel is not included in the delivery set (available separately).
- The S21 controller allows to integrate the unit into the **Smart Home** system or **BMS (Building Management System)**.
- The unit can be controlled by the **Blauberg AHU** mobile application via Wi-Fi.





Download the **Blauberg AHU** app for Android

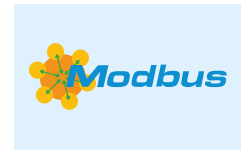

Download the **Blauberg AHU** app for iOS



Automation functions

Functions	Description
Unit control via Wi-Fi using a mobile application	+
Unit control via a wired remote control panel	S22 control panel (option) 
Unit control via a wireless remote control panel	S22 Wi-Fi control panel (option) 
Unit control via a wired remote LCD control panel	S25 control panel (option) 
BMS (Building Management System)	RS-485 Wi-Fi Ethernet MODBUS (RTU, TCP)
Blauberg Cloud Server service	+
Speed selection	+
Filter replacement indication	by filter timer by filter clogging differential pressure switch (only units with DTV)
Alarm indication	full alarm description in the mobile application
Week-scheduled operation	+
Bypass	automatic manual
Timer	+
Boost mode	+
Fireplace mode	+
Freeze protection	through cyclic stops of the supply fan through preheating (option)
Cooler connection	option
Minimum supply air temperature control	+
Humidity control	option
CO ₂ control	option
VOC control	option
PM2.5 control	option
Fire alarm sensor connection	option

Option: function is available when purchasing the appropriate accessory (see the "Accessories" section).

Designation key

Series	Motor type	Mounting type	Bypass	Heater type	Rated air flow [m³/h]	Heat exchanger type	Service side	Control	Additional elements
KOMFORT	EC: electronically commutated motor	D: suspended mounting, horizontally directed spigots	B: with a bypass	E: electric heater	300; 550; 900; 2000; 3000	- _: heat recovery E: energy recovery	L: left R: right	S21	_: no additional elements DTV: equipped with a differential pressure switch to control filter contamination

Overall dimensions [mm]

Model	Ø D	B	B1	H	L	L1
KOMFORT EC DBE 300(-E) S21	160	485	577	280	1238	1291
KOMFORT EC DBE 550(-E) S21	200	827	960	280	1238	1291
KOMFORT EC DBE 900(-E) S21	250	1351	1485	318	1349	1402
KOMFORT EC DBE 2000 S21	315	950	-	762	1400	1452
KOMFORT EC DBE 3000 S21	400	1265	-	881	1835	1888

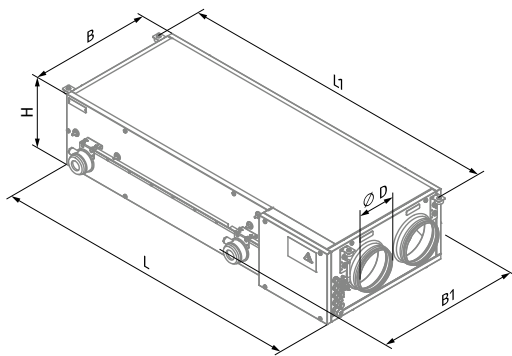

KOMFORT EC DBE 300

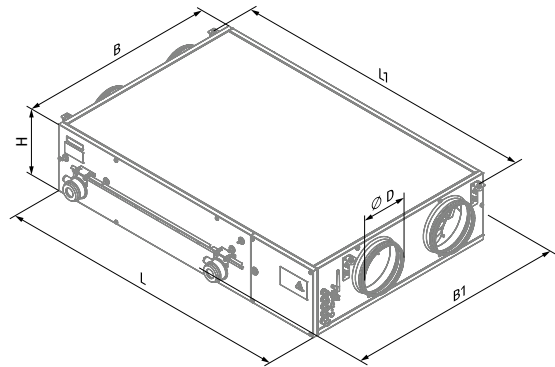

KOMFORT EC DBE 550

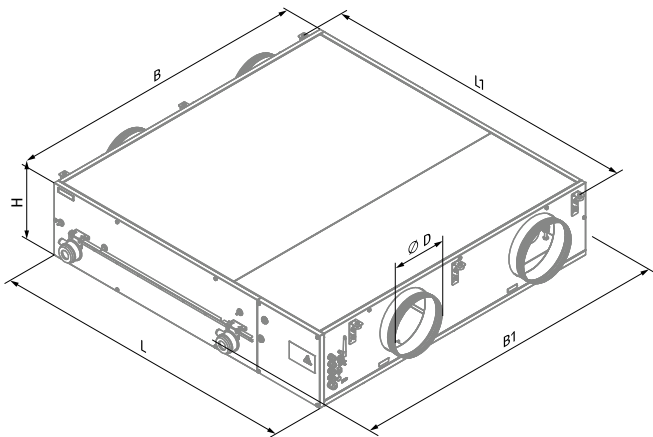

KOMFORT EC DBE 900

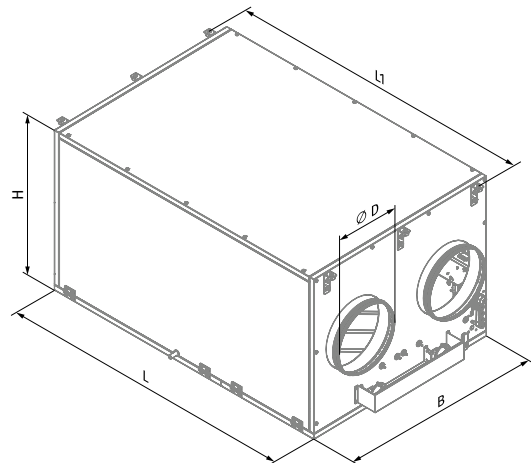

KOMFORT EC DBE 2000 / KOMFORT EC DBE 3000

HEAT RECOVERY AIR HANDLING UNITS

Technical data

Parameters	KOMFORT EC DBE 300 S21	KOMFORT EC DBE 300-E S21	KOMFORT EC DBE 550 S21	KOMFORT EC DBE 550-E S21	KOMFORT EC DBE 900 S21	KOMFORT EC DBE 900-E S21	KOMFORT EC DBE 2000 S21	KOMFORT EC DBE 3000 S21
Voltage [V / 50 (60) Hz]	1~230	1~230	1~230	1~230	1~230	1~230	3~400	3~400
Max. unit power without electric heater [W]	180	180	322	322	442	442	1063	2226
Max. unit current without electric heater [A]	1.4	1.4	2.4	2.4	3.1	3.1	4.7	3.5
Electric heater power [W]	1500	1500	2000	2000	3300	3300	15000	21000
Electric heater current [A]	6.5	6.5	8.7	8.7	14.3	14.3	21.7	30.0
Max. power with electric heater [W]	1680	1680	2322	2322	3742	3742	16063	23226
Max. current with electric heater [A]	7.9	7.9	11.1	11.1	17.4	17.4	26.4	33.5
Maximum air flow [m³/h (l/s)]	340 (94)	340 (94)	608 (169)	608 (169)	1030 (286)	1030 (286)	2100 (583)	4300 (1195)
Sound pressure level at 3 m [dBA]	27	27	30	30	33	33	36	46
Transported air temperature [°C]	-25...+40	-25...+40	-25...+40	-25...+40	-25...+40	-25...+40	-25...+40	-25...+40
Casing material	aluzinc	aluzinc	aluzinc	aluzinc	aluzinc	aluzinc	aluzinc	aluzinc
Insulation	20 mm, mineral wool	20 mm, mineral wool	20 mm, mineral wool	20 mm, mineral wool	20 mm, mineral wool	20 mm, mineral wool	25 mm, mineral wool	25 mm, mineral wool
Extract filter	G4	G4	G4	G4	G4	G4	G4	G4
Supply filter	G4 (F7 option)	G4 (F7 option)	G4 (F7 option)	G4 (F7 option)	G4 (F7 option)	G4 (F7 option)	G4	G4
Connected air duct diameter [mm]	160	160	200	200	250	250	315	400
Weight [kg]	44	44	67	67	111	111	140	281
Heat recovery efficiency [%]	72-90	69-87	78-90	69-87	75-88	69-85	50-67	59-72
Heat exchanger type	counter-flow	counter-flow	counter-flow	counter-flow	counter-flow	counter-flow	cross-flow	cross-flow
Heat exchanger material	polystyrene	enthalpy	polystyrene	enthalpy	polystyrene	enthalpy	aluminum	aluminum
SEC class	A	A	A	A	A	A	NRVU	NRVU

KOMFORT EC DBE 300

Sound power level, A-weighted	Total	Octave frequency band [Hz]								LpA 3 m	LpA 1 m
		63	125	250	500	1000	2000	4000	8000		
L _{WA} to supply inlet [dBA]	66	13	51	65	54	51	47	37	28		
L _{WA} to supply outlet [dBA]	75	14	53	68	65	67	69	64	64		
L _{WA} to exhaust inlet [dBA]	62	11	45	61	52	51	48	38	34		
L _{WA} to exhaust outlet [dBA]	71	12	47	62	66	61	64	55	61		
L _{WA} to environment [dBA]	48	17	30	43	45	36	35	31	35	27	37

Point	Unit power [W]
1	174
2	168
3	152
4	77
5	74
6	68
7	19
8	19
9	18

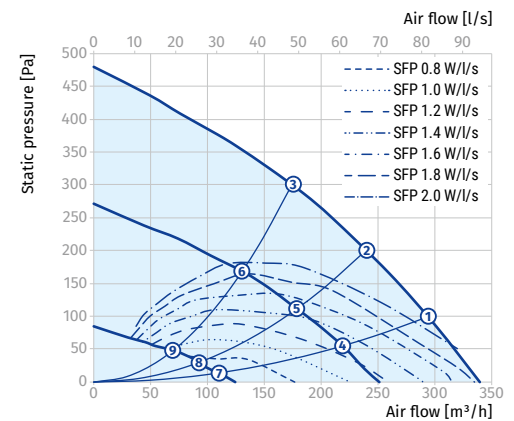

KOMFORT EC DBE 300 S21

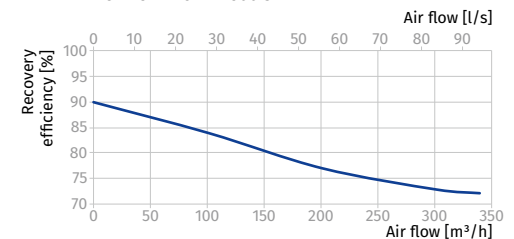

KOMFORT EC DBE 300-E S21

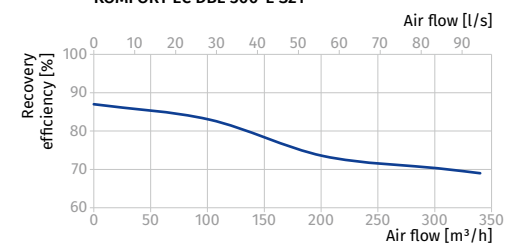

KOMFORT EC DBE 550

Sound power level, A-weighted	Total	Octave frequency band [Hz]								LpA 3 m	LpA 1 m
		63	125	250	500	1000	2000	4000	8000		
LWA to supply inlet [dBA]	69	26	60	68	54	53	48	40	29		
LWA to supply outlet [dBA]	76	27	62	71	66	68	68	66	64		
LWA to exhaust inlet [dBA]	69	26	60	68	54	53	48	40	29		
LWA to exhaust outlet [dBA]	66	24	55	65	53	53	49	41	35		
LWA to environment [dBA]	50	29	40	46	46	38	36	34	36	30	40

Data provided for point 1 of the air flow diagram

Point	Unit power [W]
1	322
2	322
3	321
4	121
5	121
6	121
7	16
8	16
9	16

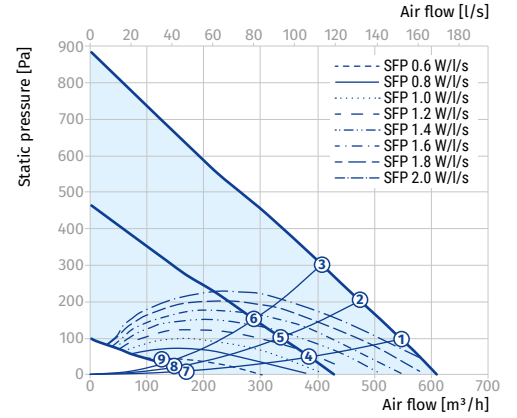

KOMFORT EC DBE 550 S21

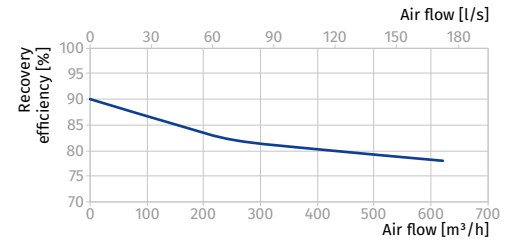

KOMFORT EC DBE 550-E S21

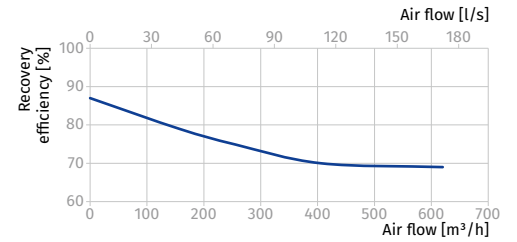

KOMFORT EC DBE 900

Sound power level, A-weighted	Total	Octave frequency band [Hz]								LpA 3 m	LpA 1 m
		63	125	250	500	1000	2000	4000	8000		
LWA to supply inlet [dBA]	80	30	64	72	69	74	73	71	71		
LWA to supply outlet [dBA]	70	29	62	69	58	59	53	45	36		
LWA to exhaust inlet [dBA]	78	29	60	69	72	70	71	64	70		
LWA to exhaust outlet [dBA]	69	28	58	68	59	61	56	48	44		
LWA to environment [dBA]	53	33	42	47	49	44	41	39	43	33	43

Point	Unit power [W]
1	442
2	442
3	442
4	160
5	149
6	147
7	46
8	43
9	40

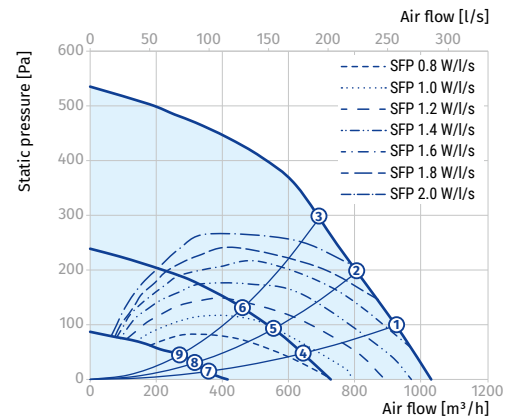

KOMFORT EC DBE 900 S21

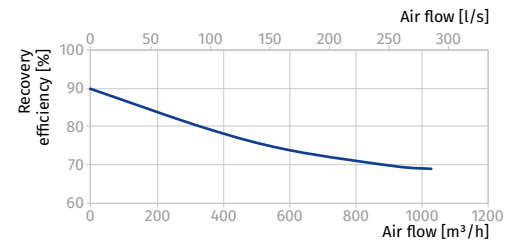

KOMFORT EC DBE 900-E S21

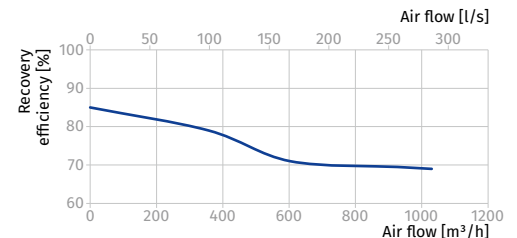

KOMFORT EC DBE 2000

Sound power level, A-weighted	Total	Octave frequency band [Hz]								LpA 3 m	LpA 1 m
		63	125	250	500	1000	2000	4000	8000		
L _{WA} to supply inlet [dBA]	75	37	68	74	61	58	51	43	31		
L _{WA} to supply outlet [dBA]	82	38	70	77	73	75	73	70	68		
L _{WA} to exhaust inlet [dBA]	72	33	61	71	60	58	53	45	40		
L _{WA} to exhaust outlet [dBA]	78	34	63	72	74	68	69	62	67		
L _{WA} to environment [dBA]	56	40	47	52	52	43	40	37	40	36	46

Point	Unit power [W]
1	1061
2	1061
3	1062
4	448
5	448
6	447
7	84
8	83
9	83

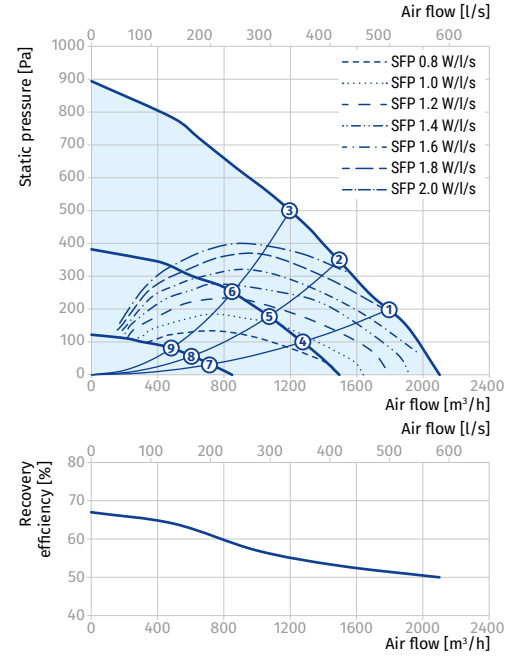







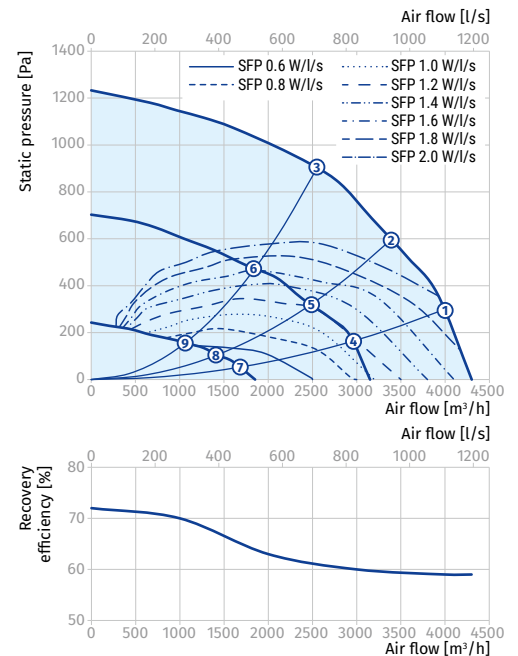









KOMFORT EC DBE 3000













Sound power level, A-weighted	Total	Octave frequency band [Hz]								LpA 3 m	LpA 1 m
		63	125	250	500	1000	2000	4000	8000		
L _{WA} to supply inlet [dBA]	90	48	83	89	72	69	60	50	37		
L _{WA} to supply outlet [dBA]	96	49	85	93	87	88	86	83	81		
L _{WA} to exhaust inlet [dBA]	86	44	75	85	71	69	62	53	47		
L _{WA} to exhaust outlet [dBA]	92	45	78	86	88	81	82	73	80		
L _{WA} to environment [dBA]	67	52	58	63	62	51	47	44	47	46	56

Point	Unit power [W]
1	2200
2	2220
3	2143
4	858
5	868
6	840
7	198
8	200
9	162



Accessories

		KOMFORT EC DBE 300 S21 KOMFORT EC DBE 300-E S21	KOMFORT EC DBE 550 S21 KOMFORT EC DBE 550-E S21	KOMFORT EC DBE 900 S21 KOMFORT EC DBE 900-E S21
G4 panel filter		FP 440x128x20 G4	FP 782x128x20 G4	FP 647x274x20 G4
G4 pocket filter		FPT 208x236x27 G4	FPT 392x236x27 G4	FPT 647x274x27 G4
F7 pocket filter		FPT 208x236x27 F7	FPT 392x236x27 F7	FPT 647x274x27 F7
Control panel		S22	S22	S22
Wireless control panel		S22 Wi-Fi	S22 Wi-Fi	S22 Wi-Fi
LCD control panel		S25	S25	S25
Humidity sensor		FS2	FS2	FS2
CO ₂ sensor with indication		CD-1	CD-1	CD-1
CO ₂ sensor		CD-2	CD-2	CD-2
Humidity sensor		HR-S	HR-S	HR-S
Electric preheater		EVH 160 S21 V.2	EVH 200 S21 V.2	EVH 250 S21 V.2
Syphon kit (for the units without an enthalpy heat exchanger)		SFK 20x32	SFK 20x32	SFK 20x32
Silencer		SD 160	SD 200	SD 250
Backdraft air damper		VRV 160	VRV 200	VRV 250
Air damper		VKA 160	VKA 200	VKA 250
Electric actuator		TF230	TF230	TF230

		KOMFORT EC DBE 2000 S21	KOMFORT EC DBE 3000 S21
G4 panel filter		FP 708x480x48 G4	FP 827x741x48 G4
Control panel		S22	S22
Wireless control panel		S22 Wi-Fi	S22 Wi-Fi
LCD control panel		S25	S25
Humidity sensor		FS2	FS2
CO ₂ sensor with indication		CD-1	CD-1
CO ₂ sensor		CD-2	CD-2
Humidity sensor		HR-S	HR-S
Syphon kit (for the units without an enthalpy heat exchanger)		SFK 20x32	SFK 20x32
Silencer		SD 315	SD 400
Backdraft air damper		VRV 315	VRV 400
Air damper		VKA 315	VKA 400
Electric actuator		TF230	TF230