

Iso-RB

Sound-insulated inline centrifugal fans

Use

- Supply and exhaust ventilation systems in premises with high requirements to the noise level and with limited space for mounting.
- Possibility of space-restricted installation above suspended ceilings.
- Compatible with Ø 100–500 mm air ducts.



Air flow:
up to 7000 m³/h
1945 l/s



Power:
from 58 W



Noise level:
from 34 dBA

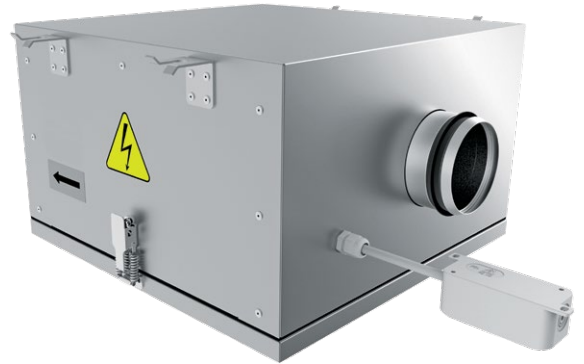

Design

- The fan casing is made of aluzinc.
- For easy installation and operation, the top cover of the fan is secured with a special lock.
- Heat- and sound insulation is made of non-combustible 50 mm mineral wool layer. To ensure better noise absorption, the inner surface of the insulation is made of a perforated metal sheet.
- The round connecting spigots are rubber sealed.

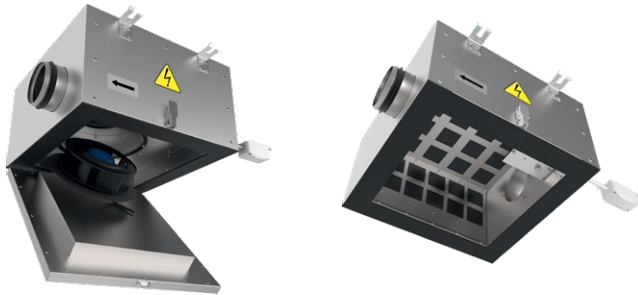

Motor

- The fans are equipped with asynchronous motors with an external rotor and centrifugal impellers with backward curved blades.
- The motors are equipped with an integrated overheating protection with automatic restart.
- The use of ball bearings with specially selected lubricating oil guarantees low noise and makes the fan completely maintenance-free.

Speed control

- Smooth or step speed control by means of a thyristor or autotransformer speed controller.
- Several fans can be connected to one controller, provided that the total power and operating current do not exceed the nominal parameters of the controller.





Mounting

- The round inline fans are designed for connection to round air ducts. The fans are installed at an air duct junction. The use of flexible connectors requires fixation of the fan on the building structure by means of supports, mounts or fixing brackets.
- The fan can be fixed in any position with respect to the air flow direction indicated by the arrow on the fan casing. While mounting the fan provide enough access for servicing and repair operations.

Designation key

Series	Spigot diameter	Motor	Options
Iso-RB	100; 125; 150; 160; 200; 250; 355; 400; 450; 500	max: high-powered motor L: low-powered motor	W1: power cable with mains plug

Accessories

Silencers	Filter boxes	Electric heaters	Water heaters	Backdraft air dampers	Air dampers	Clamps	Speed controllers		
 SD	 KFBK	 KFBT	 EKH	 WKH	 VRV	 VK / VKA	 K	 CDTE E... TP	 CDTE D... M

Overall dimensions [mm]

Type	Ø D	B	B1	H	L	L1	L2	Weight [kg]
Iso-RB 100	99	420	228	258	517	507	414	13
Iso-RB 125	124	420	228	258	517	507	414	13
Iso-RB 125 max	124	533	333	280	630	617	525	19
Iso-RB 150	149	470	278	282	566	586	493	17
Iso-RB 160	159	470	278	282	566	586	493	17
Iso-RB 200	198	535	357.5	355	632	628	535	22.6
Iso-RB 250	248	677	537	429	774	759	666	33
Iso-RB 355	354	830	641	500	927	885	804	58
Iso-RB 400	399	927	737	578	1024	957	876	78.5
Iso-RB 450 L	449	1049	858	607	1152	1049	968	84
Iso-RB 500	499	1203	993	744	1300	1263	1182	129

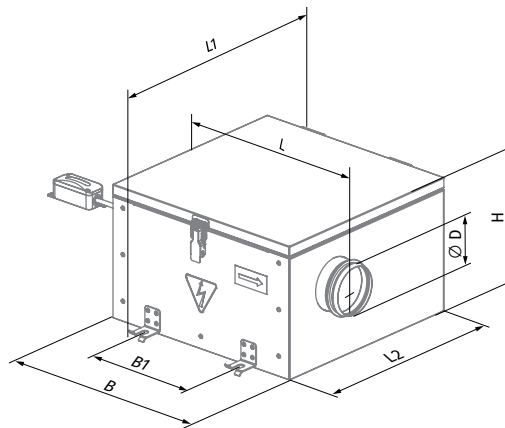

Technical data

Parameters	Iso-RB 100	Iso-RB 125	Iso-RB 125 max	Iso-RB 150
Voltage [V]	1 ~ 230	1 ~ 230	1 ~ 230	1 ~ 230
Frequency [Hz]	50	50	50	50
Power [W]	58	61	88	84
Current [A]	0.25	0.28	0.37	0.37
Maximum air flow [m ³ /h (l/s)]	285 (79)	330 (92)	484 (134)	485 (135)
RPM [min ⁻¹]	2530	2560	2670	2620
Sound pressure level at 3 m distance [dBA]	34	35	40	38
Transported air temperature [°C]	-25 ... +55	-25 ... +55	-25 ... +55	-25 ... +55
IP rating	IPX4	IPX4	IPX4	IPX4
Motor IP rating	IP44	IP44	IP44	IP44
SEC class	C	C	C	C
ErP	2018	2018	2018	2018

ISO-RB 100

Sound power level, A-weighted	Total	Octave frequency bands [Hz]								LpA 3 m	LpA 1 m
		63	125	250	500	1000	2000	4000	8000		
LWA to inlet [dBA]	62	48	57	60	52	48	42	42	32	42	52
LWA to outlet [dBA]	79	65	74	76	72	58	51	53	44	59	69
LWA to environment [dBA]	54	40	44	50	50	42	41	39	39	34	44

ISO-RB 125

Sound power level, A-weighted	Total	Octave frequency bands [Hz]								LpA 3 m	LpA 1 m
		63	125	250	500	1000	2000	4000	8000		
LWA to inlet [dBA]	63	49	57	61	52	48	42	42	33	43	53
LWA to outlet [dBA]	81	66	76	78	73	60	52	54	45	61	71
LWA to environment [dBA]	55	41	45	51	51	43	42	40	39	35	45

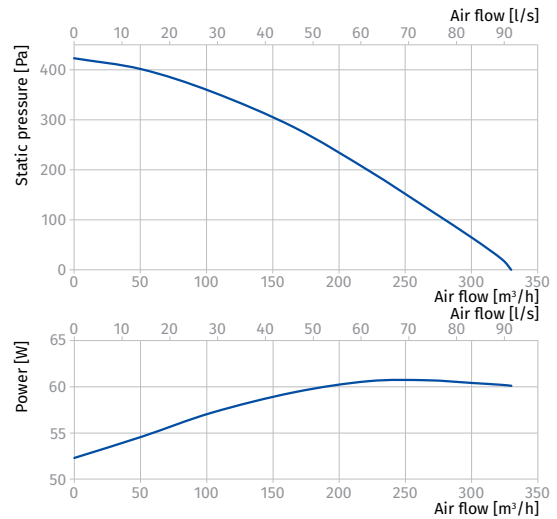
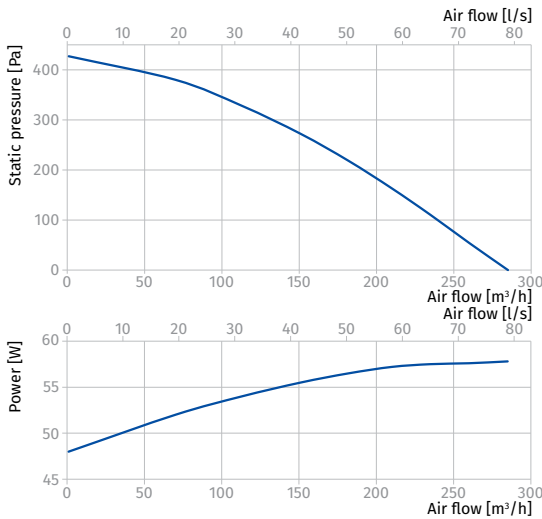

ISO-RB 125 MAX

Sound power level, A-weighted	Total	Octave frequency bands [Hz]								LpA 3 m	LpA 1 m
		63	125	250	500	1000	2000	4000	8000		
LWA to inlet [dBA]	71	56	65	70	60	55	48	48	37	51	61
LWA to outlet [dBA]	88	72	83	85	80	65	57	59	50	68	78
LWA to environment [dBA]	60	43	52	58	53	44	42	40	40	40	50

ISO-RB 150

Sound power level, A-weighted	Total	Octave frequency bands [Hz]								LpA 3 m	LpA 1 m
		63	125	250	500	1000	2000	4000	8000		
LWA to inlet [dBA]	70	55	64	68	59	54	47	47	37	50	60
LWA to outlet [dBA]	86	71	81	83	78	64	55	58	49	66	76
LWA to environment [dBA]	59	42	50	57	52	43	41	39	39	38	48

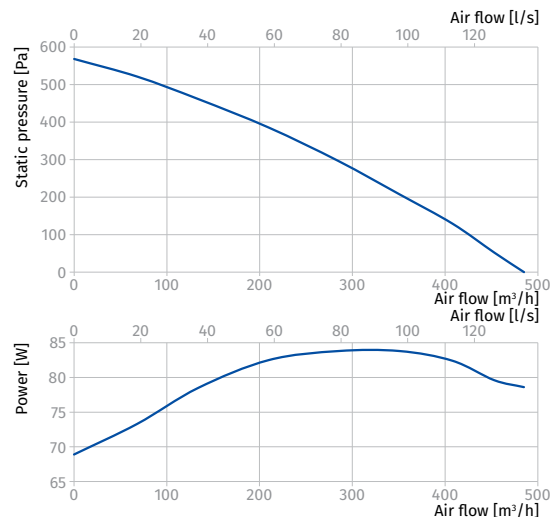
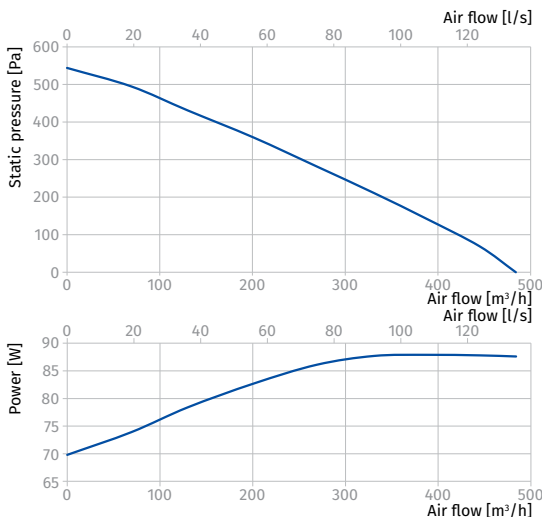

Parameters	Iso-RB 160	Iso-RB 200	Iso-RB 250
Voltage [V]	1 ~ 230	1 ~ 230	1 ~ 230
Frequency [Hz]	50	50	50
Power [W]	86	164	320
Current [A]	0.38	0.71	1.40
Maximum air flow [m³/h (l/s)]	500 (139)	770 (314)	1515 (421)
RPM [min⁻¹]	2670	2580	2615
Sound pressure level at 3 m distance [dBA]	38	42	45
Transported air temperature [°C]	-25 ... +55	-25 ... +55	-25 ... +55
IP rating	IPX4	IPX4	IPX4
Motor IP rating	IP44	IP44	IP44
SEC class	C	C	-
ErP	2018	2018	2018

ISO-RB 160

Sound power level, A-weighted	Total	Octave frequency bands [Hz]								LpA 3 m	LpA 1 m
		63	125	250	500	1000	2000	4000	8000		
LWA to inlet [dBA]	70	55	64	68	59	54	47	47	37	50	60
LWA to outlet [dBA]	87	72	83	84	79	65	56	59	49	67	77
LWA to environment [dBA]	58	42	50	57	52	43	42	39	39	38	48

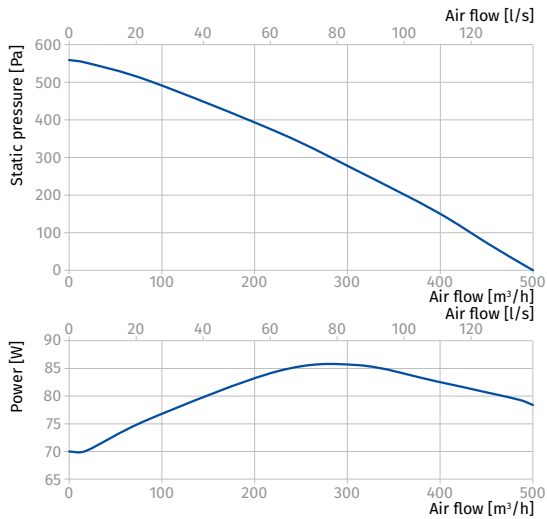

ISO-RB 200

Sound power level, A-weighted	Total	Octave frequency bands [Hz]								LpA 3 m	LpA 1 m
		63	125	250	500	1000	2000	4000	8000		
LWA to inlet [dBA]	73	57	67	71	61	57	49	49	38	53	63
LWA to outlet [dBA]	81	67	77	78	74	60	52	54	46	61	71
LWA to environment [dBA]	62	39	46	62	51	45	45	35	34	42	52

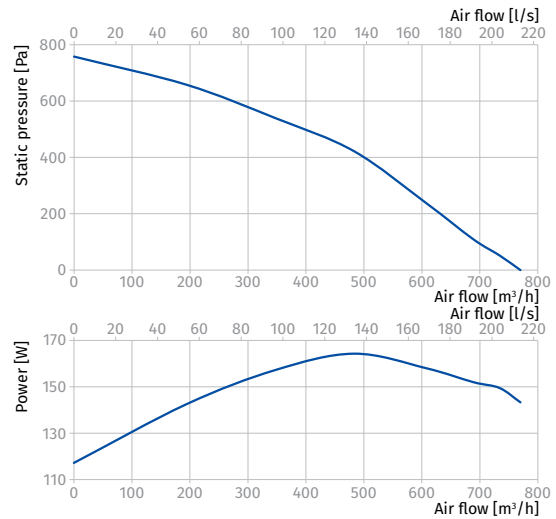

ISO-RB 250

Sound power level, A-weighted	Total	Octave frequency bands [Hz]								LpA 3 m	LpA 1 m
		63	125	250	500	1000	2000	4000	8000		
LWA to inlet [dBA]	77	60	70	75	64	59	52	52	40	56	66
LWA to outlet [dBA]	81	67	77	79	74	60	52	55	46	61	71
LWA to environment [dBA]	65	46	60	63	55	48	33	33	34	45	55

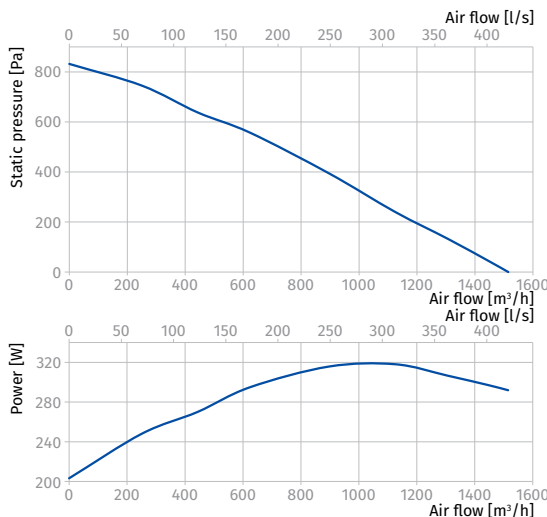

Parameters	Iso-RB 355	Iso-RB 400	Iso-RB 450 L
Voltage [V]	1 ~ 230	1 ~ 230	1 ~ 230
Frequency [Hz]	50	50 60	50
Power [W]	202	427 663	482
Current [A]	0,89	1.87 2.91	2,13
Maximum air flow [m³/h (l/s)]	2235 (621)	3800 (1056) 4100 (1139)	3750 (1042)
RPM [min ⁻¹]	1330	1451 1711	1350
Sound pressure level at 3 m distance [dBA]	48	49 50	50
Transported air temperature [°C]	-25...+55	-25...+55	-25...+55
IP rating	IPX4	IPX4	IPX4
Motor IP rating	IP44	IP54	IP54
SEC class	-	-	-
ErP	2018	2018	2018

ISO-RB 355

Sound power level, A-weighted	Total	Octave frequency bands [Hz]								LpA 3 m	LpA 1 m
		63	125	250	500	1000	2000	4000	8000		
LWA to inlet [dBA]	78	61	72	77	66	61	53	53	41	58	68
LWA to outlet [dBA]	83	68	78	80	76	61	53	56	47	63	73
LWA to environment [dBA]	68	52	66	64	47	41	32	33	33	48	58

ISO-RB 400

Sound power level, A-weighted	Total	Octave frequency bands [Hz]								LpA 3 m	LpA 1 m
		63	125	250	500	1000	2000	4000	8000		
LWA to inlet [dBA]	84	66	78	83	71	66	57	57	44	64	74
LWA to outlet [dBA]	90	74	85	87	82	66	58	60	51	69	79
LWA to environment [dBA]	70	60	56	66	65	44	43	31	24	49	59

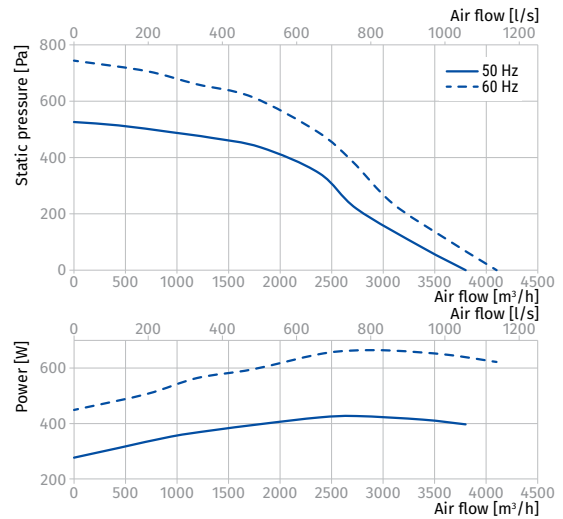
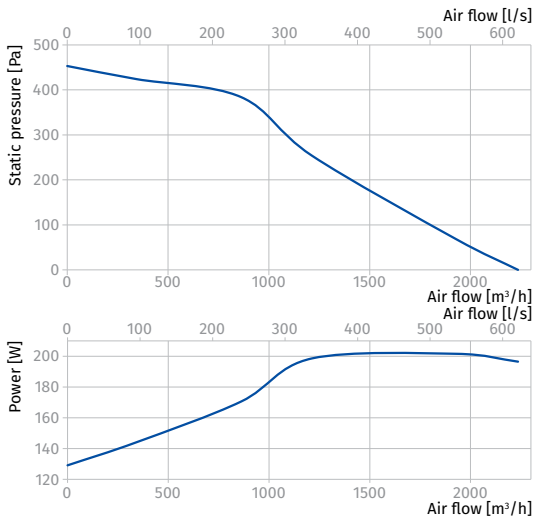

ISO-RB 450 L

Sound power level, A-weighted	Total	Octave frequency bands [Hz]								LpA 3 m	LpA 1 m
		63	125	250	500	1000	2000	4000	8000		
LWA to inlet [dBA]	82	64	75	81	69	64	56	56	43	62	72
LWA to outlet [dBA]	89	73	84	86	81	66	57	60	50	69	79
LWA to environment [dBA]	70	57	67	67	54	52	43	41	36	50	60

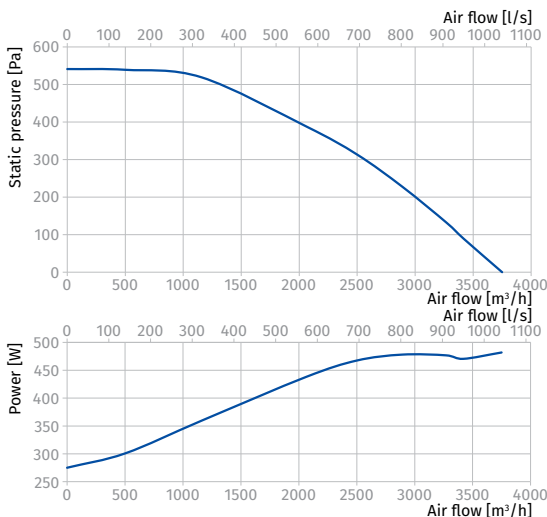

Parameters	Iso-RB 500 (Δ)	Iso-RB 500 (Y)
Voltage [V]	1 ~ 230	3 ~ 400
Frequency [Hz]	50	50
Power [W]	730	780
Current [A]	2.82	1.60
Maximum air flow [m³/h (l/s)]	7000 (1945)	6720 (1867)
RPM [min⁻¹]	980	948
Sound pressure level at 3 m distance [dBA]	56	54
Transported air temperature [°C]	-25 ... +55	-25 ... +55
IP rating	IPX4	IPX4
Motor IP rating	IP54	IP54
SEC class	-	-
ErP	2018	2018

ISO-RB 500 (Δ)

Sound power level, A-weighted	Total	Octave frequency bands [Hz]								LpA 3 m	LpA 1 m
		63	125	250	500	1000	2000	4000	8000		
LWA to inlet [dBA]	87	69	80	86	74	68	59	59	46	67	77
LWA to outlet [dBA]	92	76	88	90	84	69	60	62	52	72	82
LWA to environment [dBA]	76	68	75	67	52	50	48	46	40	56	66

ISO-RB 500 (Y)

Sound power level, A-weighted	Total	Octave frequency bands [Hz]								LpA 3 m	LpA 1 m
		63	125	250	500	1000	2000	4000	8000		
LWA to inlet [dBA]	85	66	78	83	71	66	57	57	44	64	74
LWA to outlet [dBA]	90	75	86	88	83	67	58	61	51	70	80
LWA to environment [dBA]	74	66	73	65	51	49	47	45	39	54	64

