

inWave EC

Sound-insulated inline mixed-flow fans with EC motor

Use

- Combined supply and exhaust ventilation systems of various commercial and industrial spaces with stringent noise requirements (such as libraries, conference halls, classrooms, kindergarten playrooms etc.).
- For ventilation air ducts requiring high pressure, powerful air flow and low noise level.
- Compatible with Ø 100, 125, 150 and 160 mm air ducts.



Air flow:
up to 600 m³/h
167 l/s



Power:
from 39 W



Features

- The new series of **inWave EC** duct fan series is provided with a special sound-insulated casing which ensures silent operation and excellent aerodynamic characteristics.
- inWave EC** fans combine the versatility and outstanding performance of both axial and centrifugal fans producing a powerful air flow and high pressure while retaining the signature energy-efficiency and response of EC motors.
- Several fans can be integrated into a single computer-controlled system with sensor feedback combined with speed control across the entire dynamic range.

- Conical impellers with specially profiled blades help boost angular velocity of the air flow resulting in higher pressure and air capacity compared to the conventional designs. The combination of a diffuser, a specially designed impeller and flow straightener vanes at the fan outlet allow for an optimum flow distribution to achieve high capacity and increased air pressure without generating excessive noise.
- The fan casing is equipped with an external water-tight terminal box for electrical connections.

Design

- The casing and impeller are made of high-quality durable plastic.
- The internal casing perforations conduct sound waves and direct them at the noise-absorbing material at a specific angle. Noise and heat insulation is ensured by a mineral wool layer 50 mm in thickness. Wideband noise control is achieved by means of special casing perforation and the use of noise-absorbing material.

Motor

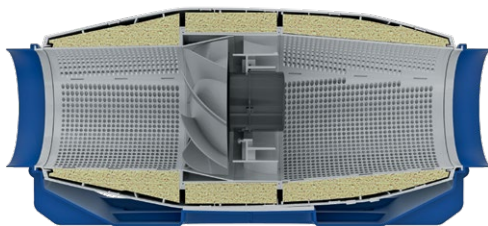

- High-efficient direct current EC motor.
- EC technology meets the up-to-date requirements to energy-saving and controllable ventilation and provides up to 35 % energy saving as compared to asynchronous motors.
- EC motor ensures totally controllable speed range for the fan and has integrated overheating protection with automatic restart.
- EC motor has no friction and wearing parts as capacitor und brushes. Instead a maintenance-free EC controller electronic circuit board is used.
- The impeller is dynamically balanced.
- The fan is compatible with 50 Hz and 60 Hz power mains and the maximum speed does not depend on power mains frequency.



Designation key

Series	Motor type	Spigot diameter [mm]	Motor modifications	Options
inWave	EC: electronically commutated motor	100/125; 150/160	max: high-powered motor	FR1: smooth speed controller adjustable from 0 to 100 % and power cable with mains plug G1: speed controller, temperature controller with external temperature sensor, power cable with mains plug W1: power cable with mains plug

Accessories

Silencers	Filter boxes	Electric heaters	Water heaters	Backdraft air dampers	Air dampers	Clamps	Speed controllers
 SD	 KFBK / KFBT	 EKH	 WKH	 VRV	 VK	 K	 CDT E/0-10

Speed control

- The fan speed is controlled with a 0–10 V control signal from the following sources:
 - integrated or external speed controller
 - controller with sensors
 - central BMS system.
- The control signal value changes depending on air temperature, pressure, smoke concentration and other parameters.
- During signal value change the fan with EC motor correspondingly changes the rotations speed and delivers required air volume to the ventilation system.
- The computer central building management systems (BMS) enable integration of several EC motors in network and precise individual operation control for each fan.

Mounting

- The fans are designed to be used with round air ducts.
- The fan casing has mounting brackets for convenient installation onto the floor, walls or ceiling. The ducts can be fitted at any angle relative to the fan axis.
- Make sure to provide sufficient maintenance access during fan installation. Electrical connection and installation must be performed in accordance with the instruction manual and the electrical connections diagram applied to the terminal box.
- A single system may have several fans installed in parallel to boost the output capacity or in series to boost the working pressure.

Overall dimensions [mm]

Type	∅ D	H	L	W	Weight [kg]
inWave EC 100/125 max (spigot 100 mm)	99	273	752	253	5.0
inWave EC 100/125 max (spigot 125 mm)	124	273	679	253	5.0
inWave EC 150/160 (spigot 150 mm)	149	273	606	253	5.0
inWave EC 150/160 (spigot 160 mm)	159	273	606	253	5.0

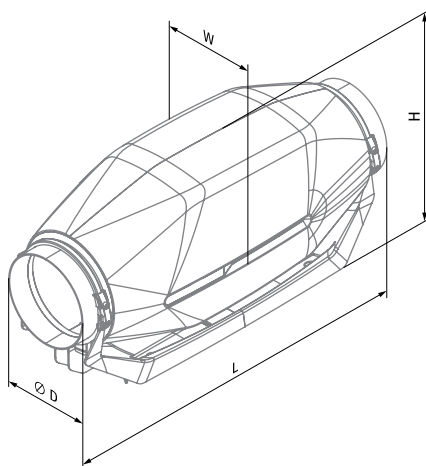

Modifications and options

- **FR1:** smooth speed controller adjustable from 0 to 100 % and power cable with mains plug.



- **G1:** speed controller, temperature controller with external temperature sensor (cable length 4 m), power cable with mains plug.
- The **G1** modification enables automatic speed control depending on indoor temperature. The optimal ventilation solution for premises requiring permanent temperature control as greenhouses, orangeries, etc.
- **W1:** power cable with mains plug.



inWave EC 100/125 max (spigot 100 mm)



inWave EC 100/125 max (spigot 125 mm)



inWave EC 150/160 (spigot 150 mm, spigot 160 mm with a rubber seal)

SOUND-INSULATED INLINE FANS

Technical data

Parameters	inWave EC 100/125 max	inWave EC 100/125 max	inWave EC 150/160
Spigot	100	125	150/160
Voltage [V / 50 Hz]	1~ 230	1~ 230	1~ 230
Power [W]	39	39	55
Current [A]	0.36	0.37	0.49
Maximum air flow [m ³ /h (l/s)]	295 (82)	450 (125)	600 (167)
RPM [min ⁻¹]	3168	3138	3506
Sound pressure at 3 m [dBA]	31	33	38
Transported air temperature [°C]	-25...+55	-25...+55	-25...+55
IP rating	IPX4	IPX4	IPX4
Motor IP rating	IP44	IP44	IP44
ErP	2018	2018	2018

To comply with ErP 2018 it is necessary to use a local demand control typology (connect the sensor).

INWAVE EC 100/125 MAX (SPIGOT 100 MM)

Sound power level, A-weighted	Total	Octave frequency bands [Hz]								LpA 3 m	LpA 1 m
		63	125	250	500	1000	2000	4000	8000		
LWA to inlet [dBA]	60	36	55	58	47	40	37	41	33	39	49
LWA to outlet [dBA]	59	32	51	58	46	36	35	41	35	38	48
LWA to environment [dBA]	52	32	49	48	39	34	30	29	24	31	41

INWAVE EC 100/125 MAX (SPIGOT 125 MM)

Sound power level, A-weighted	Total	Octave frequency bands [Hz]								LpA 3 m	LpA 1 m
		63	125	250	500	1000	2000	4000	8000		
LWA to inlet [dBA]	63	39	58	61	50	42	39	43	35	43	53
LWA to outlet [dBA]	60	33	53	59	47	37	36	42	36	40	50
LWA to environment [dBA]	54	34	51	50	41	35	30	30	25	33	43

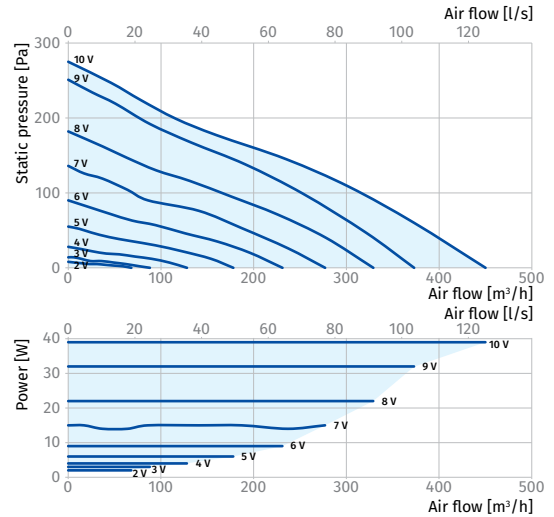
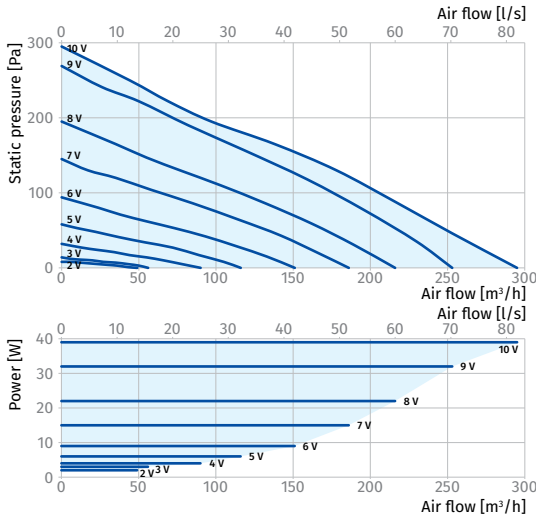

INWAVE EC 150/160

Sound power level, A-weighted	Total	Octave frequency bands [Hz]								LpA 3 m	LpA 1 m
		63	125	250	500	1000	2000	4000	8000		
LWA to inlet [dBA]	61	45	58	58	41	37	33	30	23	41	51
LWA to outlet [dBA]	58	47	58	46	43	39	32	27	20	38	48
LWA to environment [dBA]	58	48	48	50	57	45	43	36	30	38	48

