

# Helix

## Centrifugal inline fans

### Use

- Supply and extract ventilation systems installed in various premises.
- Suitable for use as ventilation or air conditioning system components.
- Compatible with round and rectangular air ducts.



**Air flow:**  
up to 2000 m<sup>3</sup>/h  
556 l/s



**Power:**  
from 125 W



**Noise level:**  
from 62 dBA



### Design

- Compact scroll casing is made of steel and is covered with a special polymer coating.
- The fan is equipped with a round intake flange and exhaust rectangular flange for connection to respective air ducts.
- External terminal block for power supply.
- The fans are equipped with fixing brackets to facilitate fastening at any level surface.

### Motor

- Two- or four-pole asynchronous motor with external rotor and centrifugal impeller with forward curved blades.
- Equipped with ball bearings for longer service life.
- Integrated thermal protection with automatic restart.
- Dynamically balanced impeller.

### Speed control

- Smooth speed control with an external thyristor controller or step speed control with an external auto transformer (both available upon separate order).

### Mounting

- The fan is designed for installation as a single unit or as a component unit of ventilation chambers or air conditioning units.
- The fan has a connection possibility for two air ducts, a rectangular discharge air duct through the flange on the casing as well as a round intake air duct through the connecting flange **FRZ-H**. Available upon separate order.

- In case of rectangular discharge air duct connection a discharge vent must be covered with the **SG-H** grille to protect the fan from foreign object ingress. Available upon separate order.

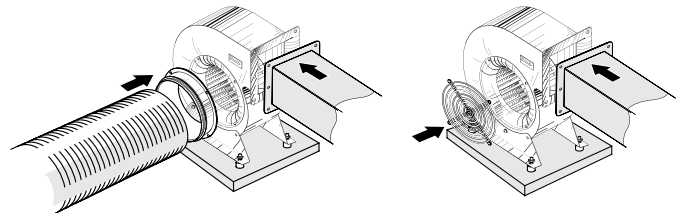

- The vibration isolators, either of rubber type **SI-G** are recommended for noise and vibration attenuation. Vibration isolators reduce dynamic loads on the fan, enhance reliability and durability of the ventilation equipment. The vibration isolators are attached through holes in the mounting pad. Available upon separate order.









SI-G

- Power is supplied to the fan through an external terminal box with sealed electric lead-in.

### Designation key

Series	Impeller diameter and width [mm]	Motor Number of poles	Phase
Helix	140x60; 160x62; 180x92; 200x80; 200x102; 225x102; 250x102; 250x140	2; 4	E: single-phase

### Accessories

Silencers	Filter boxes	Electric heaters	Water heaters	Backdraft air dampers	Air dampers	Speed controllers
 SD	 KFBK / KFBT	 EKH	 WKH	 VRV	 VKA	 CDT E1.8

### Overall dimensions [mm]

Type	∅ D	B	H	H1	H2	L	L1	L2	P	M	Weight [kg]
Helix 140x60 2E	140	243	287	125	93	86	110	78	-	-	3.7
Helix 160x62 2E	160	277	324	136	106	106	130	98	-	-	4.8
Helix 180x92 4E	180	311	360	150	120	148	170	140	-	-	7.1
Helix 200x80 4E	200	335	398	165	134	121	140	113	-	-	6.8
Helix 200x102 4E	200	335	398	165	134	157	175	148	-	-	7.3
Helix 225x102 4E	225	365	441	210	171	145	170	137	178	250	11.2
Helix 250x102 4E	250	410	485	230	191	165	190	157	198	270	16.3
Helix 250x140 4E	250	410	485	230	191	205	230	197	238	270	15.5

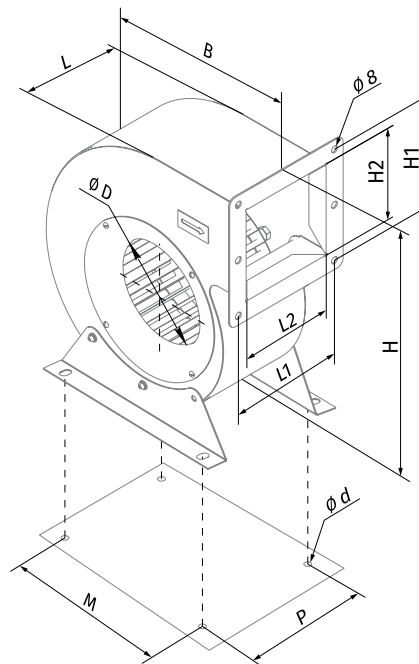

### Selection table for accessories

Type	Rubber anti-vibration mounts	Flange	Grille
Helix 140x60 2E	SI-G 8	FRZ-H 140	SG-H 140
Helix 160x62 2E	SI-G 8	FRZ-H 160	SG-H 160
Helix 180x92 4E	SI-G 8	FRZ-H 180	SG-H 180
Helix 200x80 4E	SI-G 8	FRZ-H 200	SG-H 200
Helix 200x102 4E	SI-G 8	FRZ-H 200	SG-H 200
Helix 225x102 4E	SI-G 16	FRZ-H 225	SG-H 225
Helix 250x102 4E	SI-G 16	FRZ-H 250	SG-H 250
Helix 250x140 4E	SI-G 16	FRZ-H 250	SG-H 250

## Technical data

Parameters	Helix 140x60 2E	Helix 160x62 2E	Helix 180x92 4E	Helix 200x80 4E	Helix 200x102 4E	Helix 225x102 4E	Helix 250x102 4E	Helix 250x140 4E
Voltage [V]	1 ~ 230	1 ~ 230	1 ~ 230	1 ~ 230	1 ~ 230	1 ~ 230	1 ~ 230	1 ~ 230
Frequency [Hz]	50	50	50	50	50	50	50	50
Power [W]	148	264	160	125	280	395	810	570
Current [A]	0.64	1.17	0.7	0.55	1.25	1.98	3.65	2.48
Maximum air flow [m³/h (l/s)]	515 (143)	560 (156)	800 (222)	730 (203)	1350 (375)	1480 (411)	2000 (556)	2000 (556)
RPM [min <sup>-1</sup> ]	2820	2630	1465	1430	1475	1330	1330	1310
Sound pressure at 3 m [dBA]	68	70	62	63	65	69	63	60
Transported air temperature [°C]	-25...+45	-25...+50	-25...+45	-25...+45	-25...+40	-40...+70	-40...+70	-40...+70
SEC class	C	C	B	B	-	-	-	-
IP rating	IPX4	IPX4	IPX4	IPX4	IPX4	IPX4	IPX4	IPX4
Motor IP rating	IP44	IP44	IP44	IP44	IP44	IP44	IP44	IP44
ErP	2018	2018	2018	2018	-	-	-	-

### HELIX 140x60 2E, HELIX 180x92 4E

Sound power level, A-weighted	Total	Octave frequency bands [Hz]							
		63	125	250	500	1000	2000	4000	8000
<b>Helix 140x60 2E</b>									
LWA to inlet [dBA]	60	44	51	50	37	33	31	27	17
LWA to outlet [dBA]	58	45	53	44	43	38	31	26	19
LWA to environment [dBA]	50	41	48	44	35	31	24	20	15
<b>Helix 180x92 4E</b>									
LWA to inlet [dBA]	56	43	54	52	38	34	30	29	17
LWA to outlet [dBA]	56	46	55	45	42	35	30	27	21
LWA to environment [dBA]	52	39	47	46	35	28	24	18	17

### HELIX 160x62 2E

Sound power level, A-weighted	Total	Octave frequency bands [Hz]							
		63	125	250	500	1000	2000	4000	8000
LWA to inlet [dBA]	57	42	54	54	38	34	31	28	21
LWA to outlet [dBA]	57	46	57	45	42	38	31	26	20
LWA to environment [dBA]	49	37	48	42	33	29	25	19	16

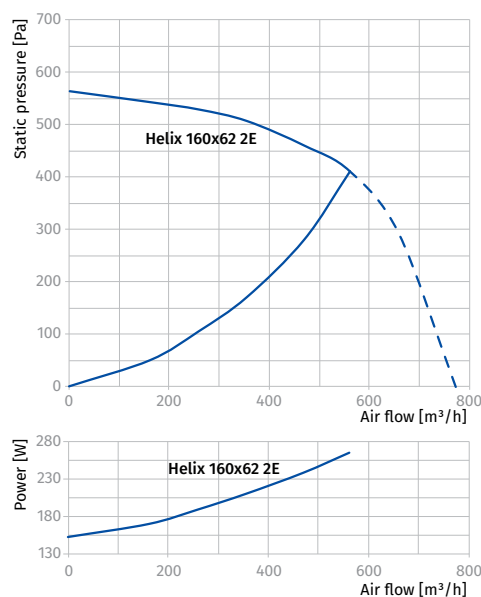
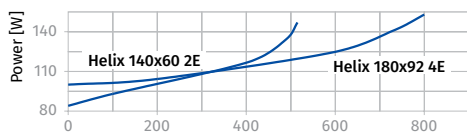
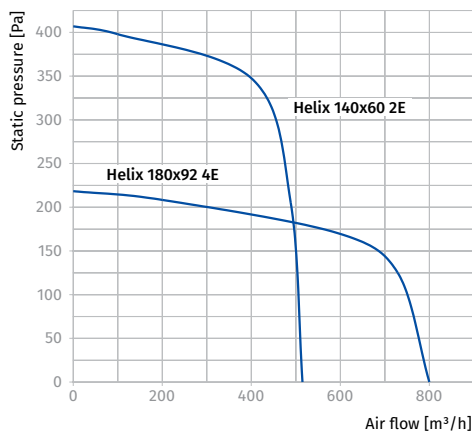

**HELIX 200x102 4E, HELIX 200x80 4E**

Sound power level, A-weighted	Total	Octave frequency bands [Hz]							
		63	125	250	500	1000	2000	4000	8000
<b>Helix 200x102 4E</b>									
L <sub>WA</sub> to inlet [dBA]	41	37	38	37	30	26	19	17	14
L <sub>WA</sub> to outlet [dBA]	42	40	41	36	36	25	16	17	18
L <sub>WA</sub> to environment [dBA]	37	32	35	29	26	20	16	11	11
<b>Helix 200x80 4E</b>									
L <sub>WA</sub> to inlet [dBA]	41	38	39	34	31	29	20	18	13
L <sub>WA</sub> to outlet [dBA]	44	40	40	36	34	25	20	16	17
L <sub>WA</sub> to environment [dBA]	37	33	37	30	25	21	16	13	13

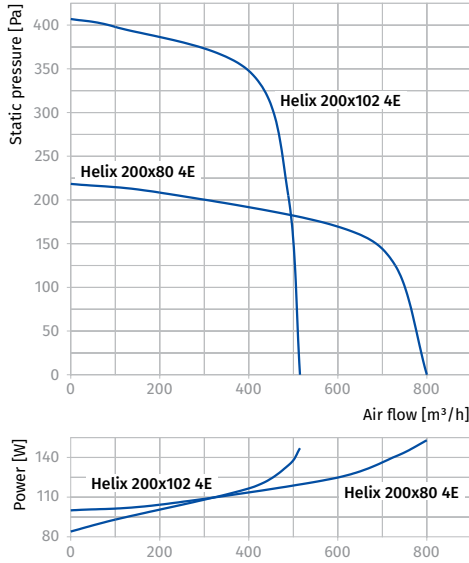

**HELIX 225x102 4E**

Sound power level, A-weighted	Total	Octave frequency bands [Hz]							
		63	125	250	500	1000	2000	4000	8000
L <sub>WA</sub> to inlet [dBA]	39	37	38	38	31	28	21	17	15
L <sub>WA</sub> to outlet [dBA]	44	37	41	38	34	27	16	17	19
L <sub>WA</sub> to environment [dBA]	37	31	33	31	25	20	17	13	11

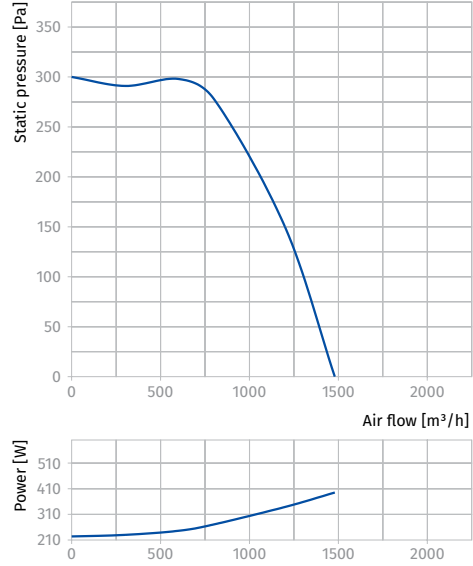

**HELIX 250x140 4E, HELIX 250x102 4E**

Sound power level, A-weighted	Total	Octave frequency bands [Hz]							
		63	125	250	500	1000	2000	4000	8000
<b>Helix 250x140 4E</b>									
L <sub>WA</sub> to inlet [dBA]	44	44	42	36	31	22	29	21	19
L <sub>WA</sub> to outlet [dBA]	46	37	42	38	29	28	29	23	21
L <sub>WA</sub> to environment [dBA]	40	34	37	31	27	21	24	17	14
<b>Helix 250x102 4E</b>									
L <sub>WA</sub> to inlet [dBA]	48	45	43	35	34	27	28	25	22
L <sub>WA</sub> to outlet [dBA]	47	41	43	35	30	29	32	24	23
L <sub>WA</sub> to environment [dBA]	45	36	39	33	31	25	26	21	18

