

FRESHBOX 200 ERV WiFi

SINGLE-ROOM AIR HANDLING UNITS

Features

- Efficient solution for supply and exhaust ventilation of enclosed spaces.
- EC fans with low energy consumption.
- Supply air cleaning is provided by the G4 and F7 filters. Additional air purification due to recirculation. H13 filter is available as an option.
- Upgradeable with an exhaust duct to provide air extraction from the bathroom.
- Easy installation.
- Compact size.
- Controlled by Android or iOS smartphone or tablet over Wi-Fi.



Air flow:
up to 200 m³/h
56 l/s



Heat recovery efficiency:
up to 85 %



Design

- The casing is made of polymer coated steel plates.
- The front panel provides convenient access for filter maintenance and has a lock for extra security.
- The unit has two Ø 100 mm pipes for fresh air intake and stale air extraction outside. The third Ø 100 mm pipe (included in the scope of delivery) can be additionally fitted to the unit to connect the exhaust air duct from the bathroom.
- Available modifications with an integrated preheater and reheater for cold climate applications.

Motors

- The units feature efficient electronically commutated (EC) motors with an external rotor and impellers with forward curved blades. These state-of-the-art motors are the most advanced solution in energy efficiency today.
- EC motors are characterised with high performance and optimum control across the entire speed range. In addition to that the efficiency of electronically commutated motors reaches very impressive levels of up to 90 %.

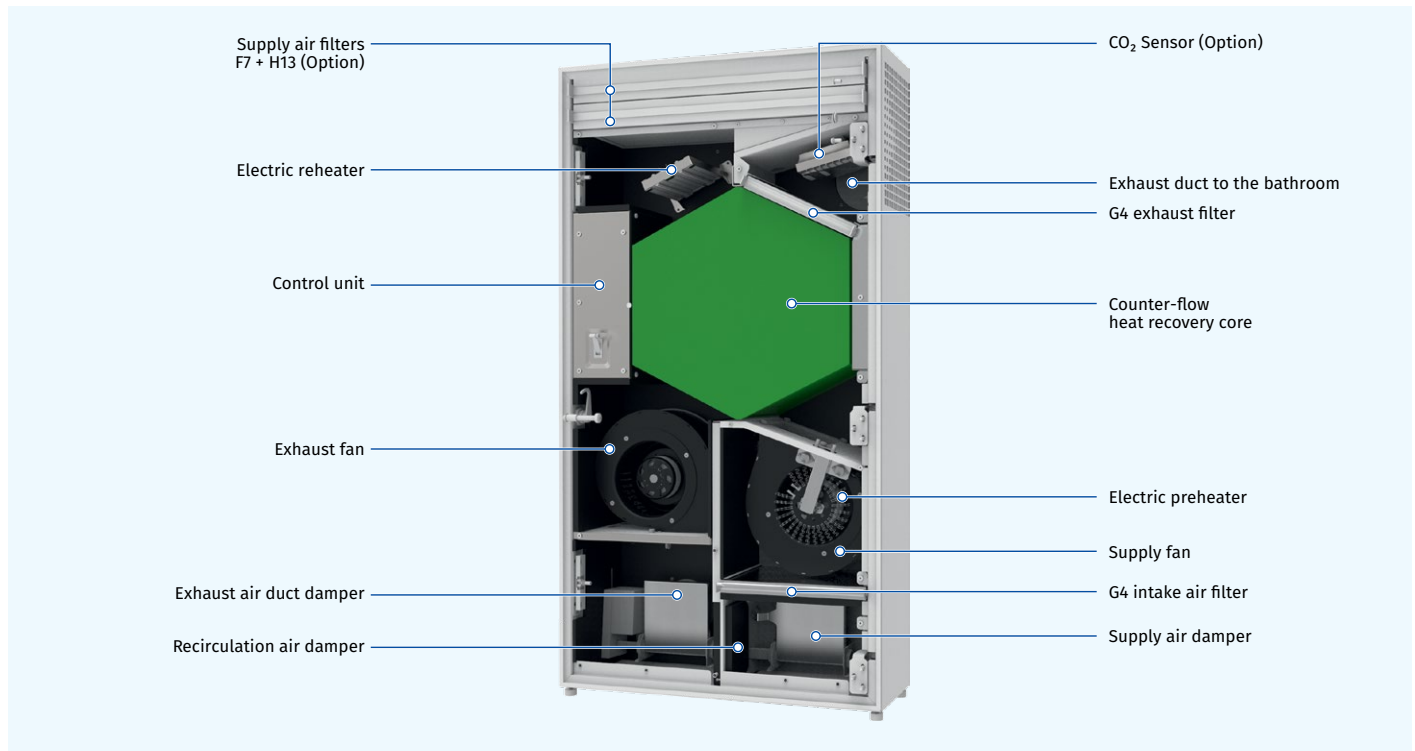

Designation key

Model	Heater	Rated air flow [m ³ /h]	Heat exchanger type	Control
Freshbox	_ : no heater E: preheating E1: reheating E2: preheating + reheating	- 200	ERV: energy recovery	WiFi: sensor control panel and Wi-Fi communication

FRESHBOX 200 ERV WiFi

SINGLE-ROOM AIR HANDLING UNITS

Air dampers

- The unit is equipped with supply and exhaust air dampers which activate automatically to prevent drafts while the unit is off.

Air filtration

- Supply air cleaning is provided by the G4 and F7 filters. To meet more stringent air purity requirements the F7 filter can be replaced with an H13 Filter (purchased separately).
- Exhaust air is cleaned by the panel filter G4.

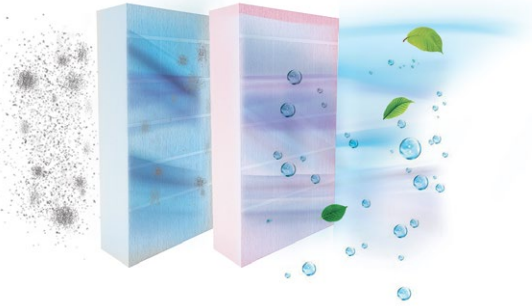

Heaters

PREHEATING

- Freshbox E-200 ERV WiFi, Freshbox E2-200 ERV WiFi** units are equipped with an electric preheater for freeze protection of the heat exchanger.

REHEATING

- Freshbox E1-200 ERV WiFi, Freshbox E2-200 ERV WiFi** units feature an electric reheater to raise the supply air temperature as necessary.

Freeze protection

- The **Freshbox 200 ERV WiFi** features an exhaust air temperature sensor downstream of the heat exchanger which disables the supply fan to let the warm extract air warm up the heat exchanger. Then the supply fan is turned on and the unit reverts to normal operation.
- Freeze protection for **Freshbox E-200 ERV WiFi** and **Freshbox E2-200 ERV WiFi** is implemented with an electric preheater.

Heat and energy recovery

- The unit is equipped with a counter-flow energy recovery core with an enthalpy membrane at the core.
 - In the cold season** the exhaust air heat and moisture are transferred to the supply air stream through the enthalpy membrane reducing the heat losses through ventilation.
 - Consequently, it is the intake air heat and moisture transferred to the extract air stream **in the warm season**. This allows for a considerable reduction of the supply air temperature and humidity which, in turn, reduces the air conditioning load.



Operating principle

HEAT RECOVERY OPERATION MODE

- The cold outdoor air** passes through the filters and the heat exchanger and then is delivered to the serviced space by the supply centrifugal fan.
- Warm polluted air from the premise** flows through the filter and the heat exchanger and is exhausted outside with an extract centrifugal fan through an air duct in the wall.
- The supply and exhaust air** flows are fully separated which helps eliminate the possibility of odour or microbial transfer between the streams.

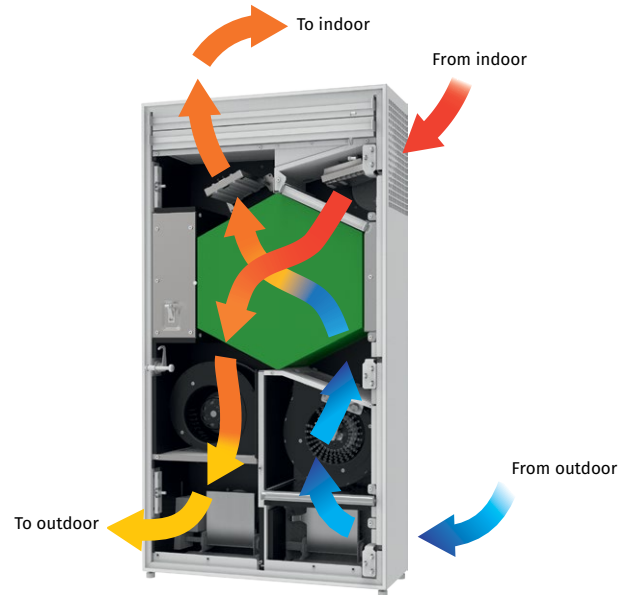

RECIRCULATION OPERATION MODE

- The supply and exhaust air dampers are closed, the recirculation damper is open. The room air circulates through the filters. Then it is returned back to the room purified.

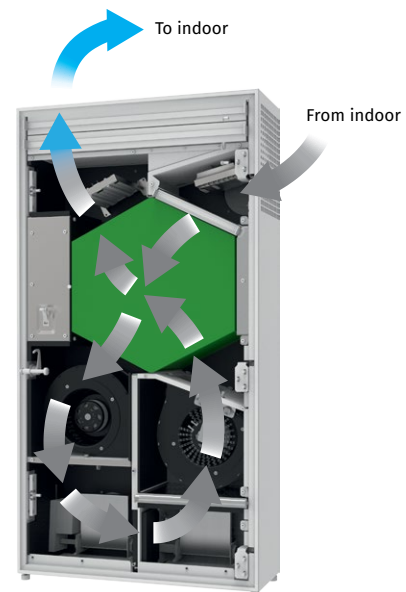

FRESHBOX 200 ERV WiFi

SINGLE-ROOM AIR HANDLING UNITS

Control

- The unit is equipped with a control panel.
- The remote control is supplied as standard
- Wi-Fi communication.



AUTOMATIC FUNCTIONS

	Freshbox 200 ERV WiFi Freshbox E-200 ERV WiFi	Freshbox E1-200 ERV WiFi Freshbox E2-200 ERV WiFi
Speed selection	•	•
Filter replacement indication	•	•
Alarm indication	•	•
Speed setup	•	•
Timer	•	•
Week scheduler	•	•
Reheater enabled/disabled		•
Supply air temperature setup		•
Control with the mobile application Android / iOS	•	•



Download
Android application
Blauberg Freshbox

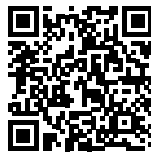

Download
iOS application
Blauberg Freshbox

REMOTE CONTROL

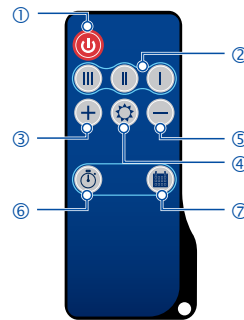

- 1 Turning unit on/off
- 2 Speed selection (Min/Mid/Max)
- 3 Increasing temperature set point for the reheater (available for the models with a reheater)
- 4 Turning reheater on/off (available for the models with a reheater)
- 5 Decreasing temperature set point for the reheater (available for the models with a reheater)
- 6 Turning timer on/off
- 7 Activation/deactivation of the scheduled operation mode

CONTROL PANEL

- ON/OFF button
- Speed changeover (down)
- Speed changeover (up)
- Weekly schedule
- Connection to WiFi
- Filter replacement indication
- Alarm indication

Technical data

Parameters	Freshbox 200 ERV WiFi					Freshbox E-200 ERV WiFi					Freshbox E1-200 ERV WiFi					Freshbox E2-200 ERV WiFi				
	I	II	III	IV	V	I	II	III	IV	V	I	II	III	IV	V	I	II	III	IV	V
Speed																				
Voltage [V / 50 (60) Hz]	1~230																			
Max. power without heater(s) [W]	10	15	25	44	134	10	15	25	44	134	10	15	25	44	134	10	15	25	44	134
Preheater power consumption [W]								650										650		
Reheater power consumption [W]													700					700		
Max. current consumption with heater(s) [A]				1.0				4.0					4.2					7.2		
Maximum air flow [m³/h (l/s)]	30 (8)	60 (17)	90 (25)	120 (33)	200 (56)	30 (8)	60 (17)	90 (25)	120 (33)	200 (56)	30 (8)	60 (17)	90 (25)	120 (33)	200 (56)	30 (8)	60 (17)	90 (25)	120 (33)	200 (56)
RPM [min ⁻¹]	2000																			
Sound pressure level at 3 m [dBA]	12	22	30	36	45	12	22	30	36	45	12	22	30	36	45	12	22	30	36	45
Transported air temperature [°C]	-15...+40																			
Casing material	polymer coated steel																			
Insulation thickness [mm]	30																			
Extract filter	G4																			
Supply filter	G4 + F7 (Option: H13)																			
Connected air duct diameter [mm]	100																			
Weight [kg]	55																			
Heat recovery efficiency [%]*	85	81	75	68	66	85	81	75	68	66	85	81	75	68	66	85	81	75	68	66
Heat recovery core type	counter-flow																			
Heat recovery core material	enthalpic membrane																			
SEC class	A																			

*Heat recovery efficiency is specified in compliance with EN 13141-8.

FRESHBOX 200 ERV WiFi

SINGLE-ROOM AIR HANDLING UNITS

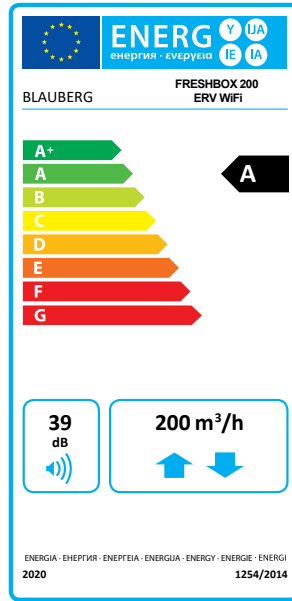
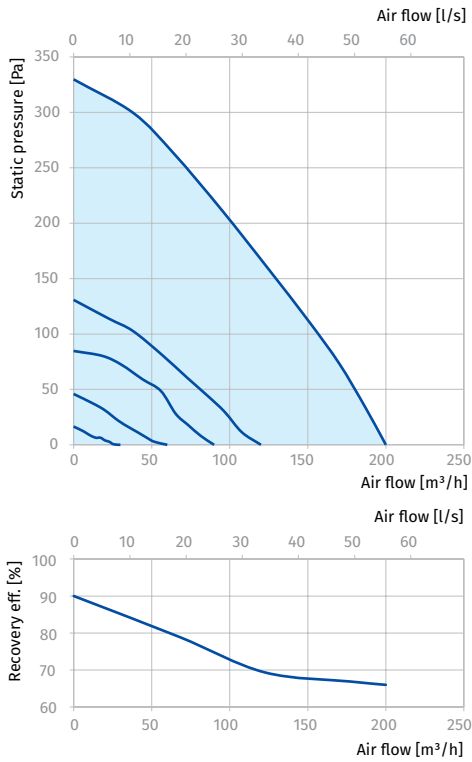

Overall dimensions [mm]

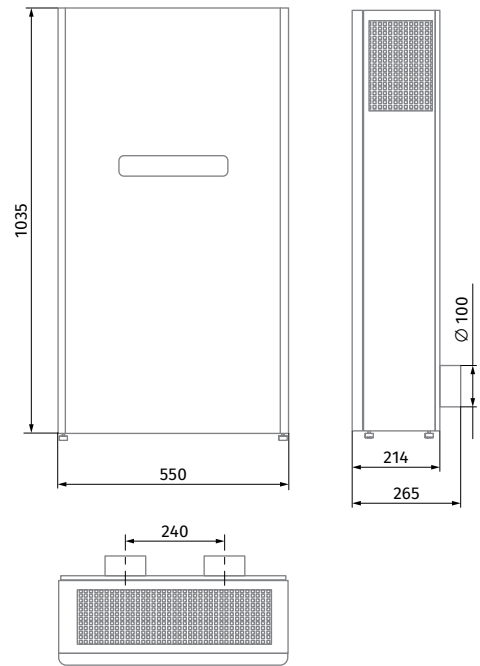

FRESHBOX 200 ERV WiFi

SINGLE-ROOM AIR HANDLING UNITS

Mounting example

Each space requiring ventilation is equipped with one or several **Freshbox 200 ERV WiFi** units.

Can be upgraded with a bathroom exhaust air duct. To enable such a configuration the units can be additionally equipped with the optional \varnothing 100 mm spigot (supplied as standard).

FRESHBOX 200 ERV WiFi MOUNTING EXAMPLE IN THE OFFICE

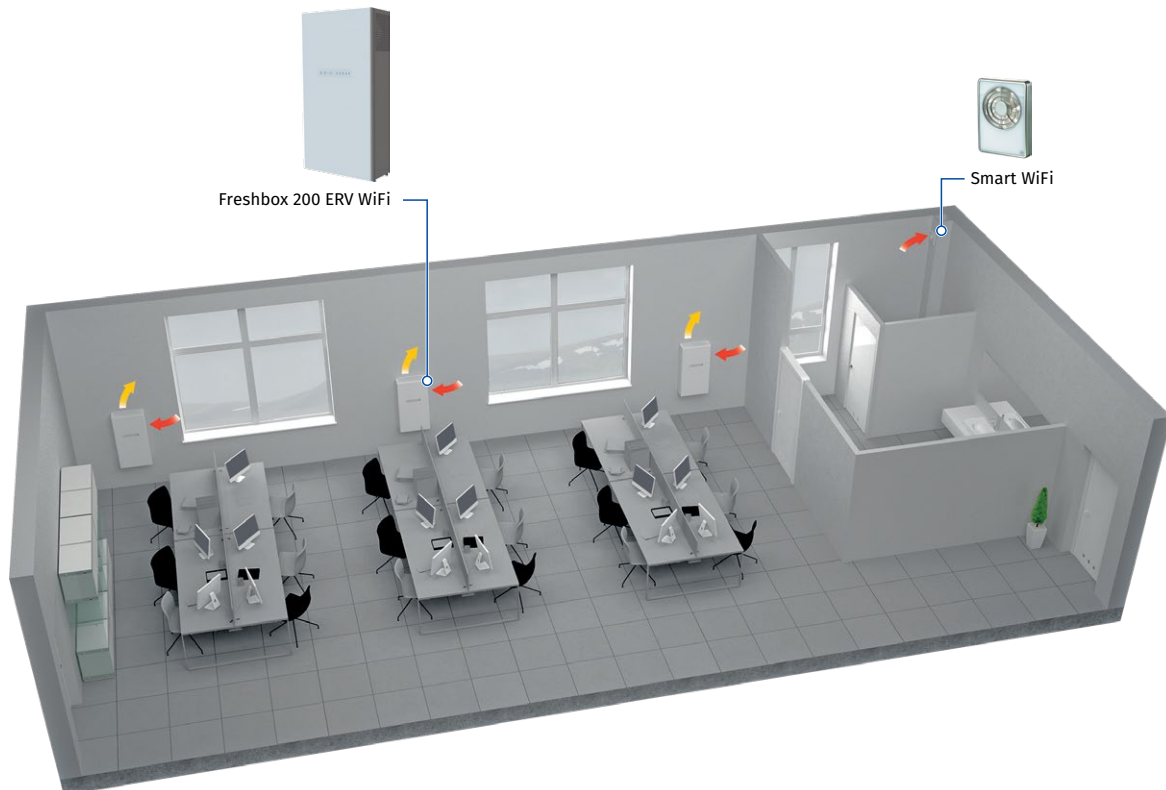



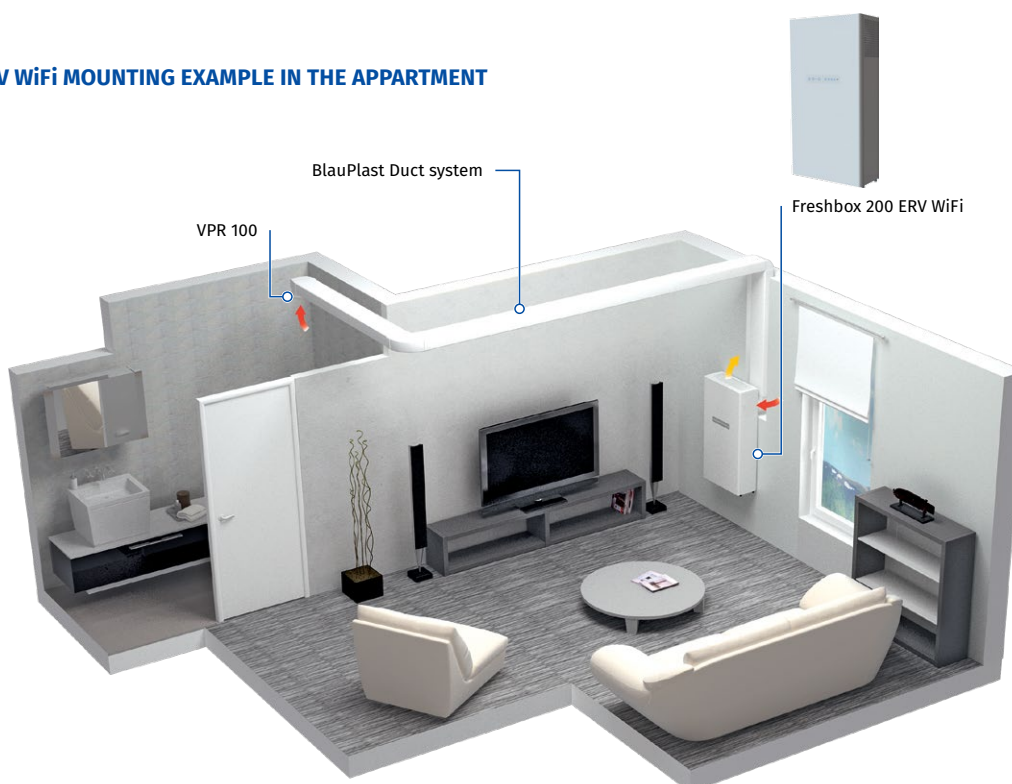







FRESHBOX 200 ERV WiFi MOUNTING EXAMPLE IN THE APARTMENT



FRESHBOX 200 ERV WiFi

SINGLE-ROOM AIR HANDLING UNITS

Accessories

Name		Description
MS Freshbox 200 chrome		Mounting kit: <ul style="list-style-type: none"> • Two Ø 100 mm air ducts, 500 mm long • Ventilation outer hood made of polished steel • Cardboard template
MS Freshbox 200 white		Mounting kit: <ul style="list-style-type: none"> • Two Ø 100 mm air ducts, 500 mm long • Ventilation outer hood, painted white • Cardboard template
AH Freshbox 200 chrome		Ventilation outer hood made of polished steel
AH Freshbox 200 white		Ventilation outer hood, painted white
FP 201x162x20 G4		Exhaust G4 panel filter
FP 243x162x20 G4		Supply G4 panel filter
FP 502x162x40 F7		Supply F7 panel filter
FP 502x162x40 H13		Supply HEPA H13 panel filter
HR-S		Humidity sensor
CD-1		CO ₂ sensor with LED CO ₂ indication and a sensor button for operation mode selection
CD-2		CO ₂ sensor