



MEDIUM PRESSURE AXIAL FANS AND AXIAL SMOKE EXTRACTION FANS

Standard sizes 1400 and 1600 mm

SMOKE EXTRACTION PRODUCT CATALOGS



MEDIUM PRESSURE AXIAL FANS AND AXIAL SMOKE EXTRACTION FANS



CENTRIFUGAL SMOKE EXTRACTION FANS



SMOKE EXTRACTION VENTILATION FOR PARKING PREMISES



FIRE SAFETY DAMPERS



60 Hz



MEDIUM PRESSURE AXIAL FANS AND AXIAL SMOKE EXTRACTION FANS



60 Hz



SMOKE EXTRACTION VENTILATION FOR PARKING PREMISES



COMPLETE SOLUTIONS FOR AXIAL FANS

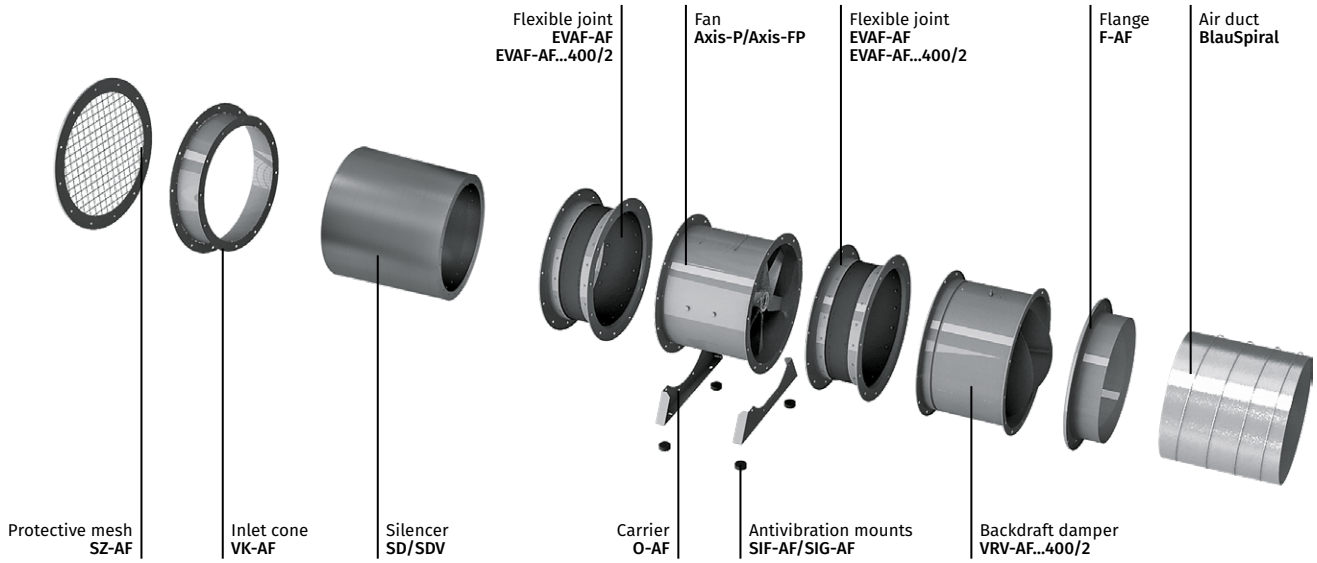

Installation example of axial fans on rooftop

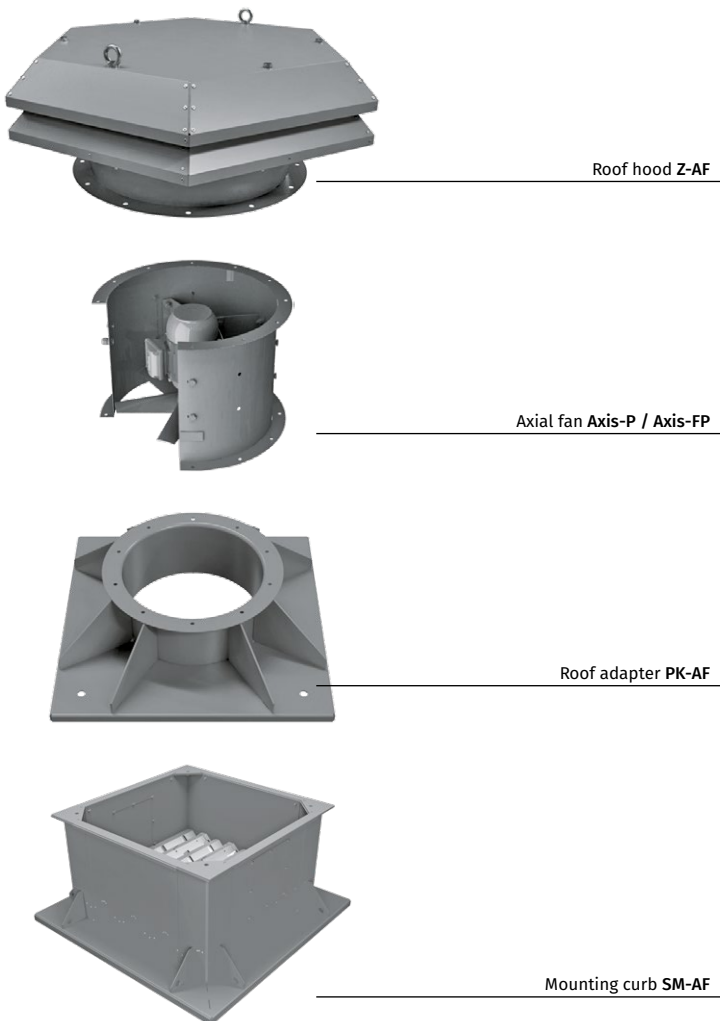

FAN INSTALLATION INTO AN AIR DUCT SYSTEM

- o To ensure a uniform air flow, the fan should be preceded by a straight duct section with a cross-section area equal to half of that of the fan. The length of the duct section should be $3 \div 4 D$ (D is the inner diameter of the fan). The length of the straight duct section downstream of the fan should be $1.5 \div 2 D$.
- o Reduction of the recommended duct length values results in a drop of the fan pressure and performance. To reduce noise and vibration, use the VVGF flexible joints.

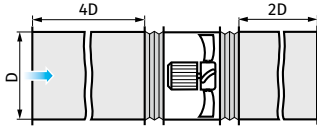

FAN INSTALLATION WITH NO UPSTREAM DUCTING

- o Axial fans without upstream ducting must be equipped with a VK-AF inlet cone to improve the air flow parameters.

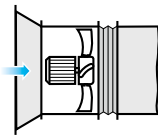

FAN INSTALLATION WITH NO DOWNSTREAM DUCTING

- o If the axial fan is a terminal device of the ventilation system (i.e. there is no downstream ducting), the unit must be equipped with a diffuser to reduce the air flow velocity and the fan dynamic pressure. Reduction of the air discharge velocity results in a significant reduction of shock losses which are proportional to the square of velocity decrement.
- o The fan should not be equipped with a downstream contractor.

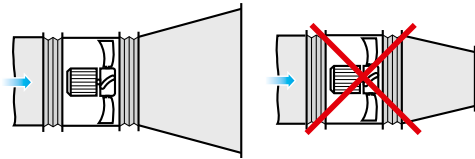

INSTALLATION NEAR BENDS

- o To install the fan directly downstream of a bend (elbow), use a curved section with a large bending radius or an array of internal guide vanes.

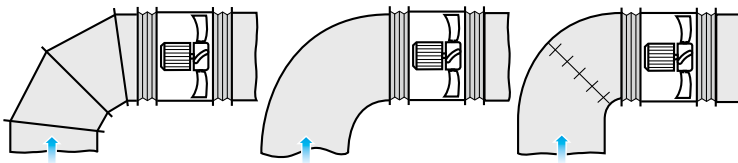

CHANGING DIAMETER INSTALLATION

- o When changing from a smaller diameter to a larger one use a connector diffuser with the maximum opening angle of 12° .

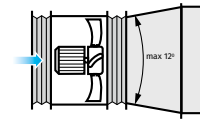

OBSTRUCTED SPACE INSTALLATION

- o To ensure normal operation of the fan in an obstructed space, make sure to provide for a sufficient distance between the inlet and outlet flanges and the floor, walls, bulky equipment and obstacles.

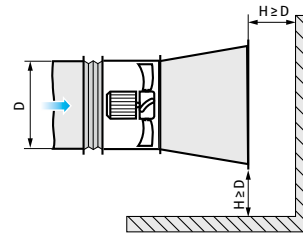
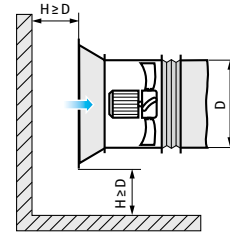

AXIS-P / AXIS-FP

Medium pressure axial fans 1400 and 1600 mm series

Use

- The fans are used:
 - as a part of a smoke extraction system for air pressurization to create a positive air pressure differential in stairway enclosures, airlock vestibules and lift shafts, to prevent spreading of smoke in premises, protect people using evacuation routes from fire hazards and enable conditions for fire-extinguishing measures.
 - for extraction of smoke in case of fire and removal of hot air outside.
 - in general ventilation systems in industrial, administrative and residential buildings.

Air flow
50 Hz:
 4 poles – up to 294 000 m³/h
 6 poles – up to 236 000 m³/h
60 Hz:
 6 poles – up to 256 000 m³/h
 8 poles – up to 218 000 m³/h

Pole number: 4, 6, 8, 4/6, 4/8

Motor power
50 Hz:
 4 poles – up to 132 kW
 6 poles – up to 75 kW
 8 poles – up to 55 kW
60 Hz:
 6 poles – up to 90 kW
 8 poles – up to 75 kW



Axis-FP

Design

- The metal casing with rolled flanges helps achieve outstanding rigidity and minimum clearances between the casing and the blades.
- There is an inspection hatch in the casing for easy maintenance.
- All the casing components are powder coated for improved protection against the environmental effects.
- The fan casing can be hot-dip galvanized on request.
- The fan can be equipped both with a standard and a shortened casing.

Operation temperatures

- The fans are rated for continuous operation at ambient air temperatures from -60 °C up to +50 °C (depends on climatic category, see the Designation key).
- The fans are able to operate 2 hours at the temperatures +300 °C and +400 °C.
- The fans with a fire resistance class of 200 °C/2 hours can be produced on special request.

Motor

- The fans are equipped with three-phase (400 V, 50 or 60 Hz) single-speed or two-speed electric motors with IE3 energy efficiency class on request.
- Motor ingress protection rating is IP55.
- Power of applied electric motors:
 - 4-pole – up to 132 kW, for fan size 1600 – 50 Hz.
 - 6-pole – up to 90 kW, for fan size 1600 – 60 Hz.

Aerodynamic parameters

Standard size: 1400, 1600
 Pole number: 4
 Frequency: 50 Hz

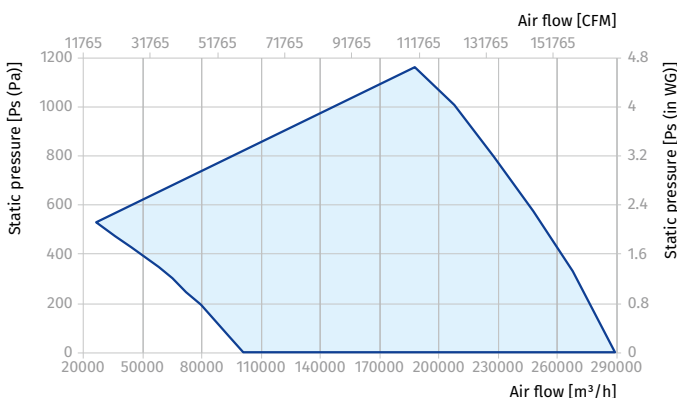

Impeller

- Aerodynamic impeller blades ensure high efficiency of the fan while keeping noise well under control.
- The impellers are dynamically balanced.
- Low weight and low moment of the impeller inertia help reduce the fan start-up time.
- The fan blades can be made of the following materials:
 - PAG – fiberglass reinforced polyamide for pressurization fans
 - AL – die-cast aluminium for pressurization and smoke extraction fans
 - ST – steel for smoke extraction fans
- For smoke extraction fans, only impellers made of die-cast aluminium or steel are used, capable of operating according to the selected fire resistance class of the unit.
- Please confirm the blade material while placing your order.

Mounting

- The fans can be mounted on any flat surface or directly into a ventilation duct.
- The units are suitable for both horizontal and vertical configurations.
- In-duct installation requires flanges to attach the fan to the ductwork.
- To attach the fan to the floor, a wall or the ceiling use the **O-AF** carriers (not included as standard, should be purchased separately).
- The units are suitable for installation on rooftops to provide direct supply of outdoor air to the stairway areas.

Standard size: 1400, 1600
 Pole number: 6
 Frequency: 60 Hz

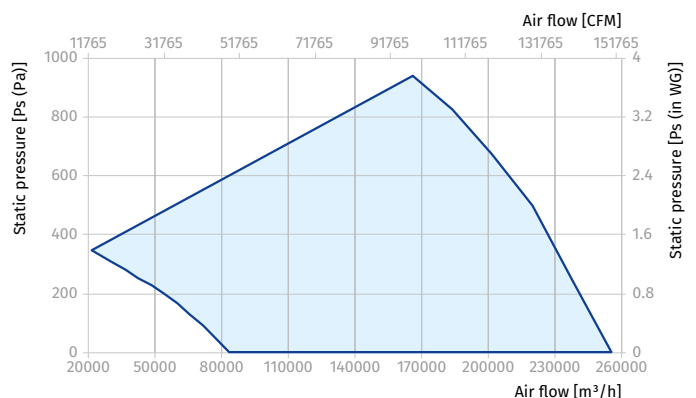

Blauberg Ventilatoren GmbH
Aidenbachstr. 52
D-81379 Munich

info@blaubergventilatoren.de
www.blaubergventilatoren.de

Technical changes reserved.
Illustrations and texts are non-binding.