

COMPACT UNITS

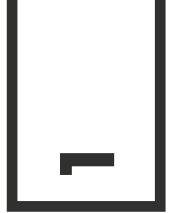

2026







2
COMPACT UNITS

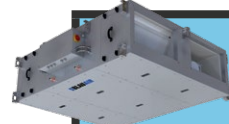

4
BLAUAIR CFH



6
BLAUAIR CFP



8
BLAUAIR CFV



10
BLAUAIR RH



12
BLAUAIR RP



14
BLAUAIR RV

16
S37 AUTOMATION

CONTENTS

COMPACT UNITS

THE UPDATED SERIES
OF STANDARD COMMERCIAL
AIR HANDLING UNITS,
EXTENDED WITH NEW SIZES
AND CONFIGURATIONS



700 – 20 000 m³/h



The **Compact** series of air handling units provides a cost-efficient and space-optimized solution, available in multiple sizes to accommodate a wide range of airflow requirements.

The suspended version enables easy integration into ceiling voids, even in confined spaces.

Vertical duct connection allows optimization of air duct arrangement.

The compact design, along with dividing larger units into sections, facilitates easy transportation to the installation site.

FEATURES

All units are available with two frameless casing options: BL – 40 mm panel construction and an enhanced 50 mm version with PVC profiles – BLS.

Units with a 40 mm casing have lower weight and good thermal performance: T3, TB4

Units with PVC profile casing have minimized heat loss, improved thermal performance (T2, TB2), and reduced noise levels.

Integrated water and electric heaters in vertical units.

Hygroscopic rotary heat exchanger as an option.

Compact height for ceiling-mounted units (from 295 mm) and optimized width (from 800 mm) for the vertical ones.

Control box mounted on the casing, outside the unit for suspended units.

High performance with optimized costs T2 / TB2 / L1 / D1

Technical Specifications According to EN 1886:2009

	D1	D2		D3	
Mechanical Strength (mm × m⁻¹)	4	10		> 10	
Casing Air Leakage (l × s⁻¹ × m⁻²)	L1 (f400)	L2 (f400)		L3 (f400)	
	0.15	0.44		1.32	
	L1 (f700)	L2 (f700)		L3 (f700)	
	0.22	0.63		1.90	
Filter Bypass Leakage (k in %)	F9	F8	F7	M6	G1-M5
	0.5	1	2	4	6
Thermal Transmittance (W × m⁻² × K⁻¹)	T1	T2	T3	T4	T5
	U < 0.5	0.5 < U ≤ 1.0	1.0 < U ≤ 1.4	1.4 < U ≤ 2.0	2.0 < U
Thermal Bridging Factor	TB1	TB2	TB3	TB4	TB5
	0.75 < k _b < 1.00	0.60 ≤ k _b < 0.75	0.45 ≤ k _b < 0.60	0.30 ≤ k _b < 0.45	k _b < 0.3



BLAUAIR CFH

FLOOR MOUNTED HEAT RECOVERY UNITS



FEATURES

High-efficient counterflow heat exchanger made of profiled polystyrene plates, packed with elastic heat-resistant sealant. Stainless steel drain pan on both supply and exhaust sides.

High-efficient EC fans, back ward-curved, external rotor. Integrated plug-and-play controls.

Automatic bypass. ECO-Design'18 compliant. Polystyrene plate heat exchanger. Panel filters ePM1 70% (ISO 16890)-F7 (EN779). Hinged service doors.

Web interface, MODBUS, outputs for optional DX or Hydronic cooling / heating.

Complete set of accessories: silencers, economizers, VAV, CAV, etc.

Operation by RH/CO₂/temperature/constant pressure/timer schedule.

Best suited for: a broad range of applications, from private residential buildings to large commercial and public facilities, including offices, educational institutions, public buildings, and facilities with restricted indoor installation areas. Suitable for both indoor and outdoor installation. Outdoor installation available with an optional mounting kit.



Sizes and capacities of BL and BLS Compact units

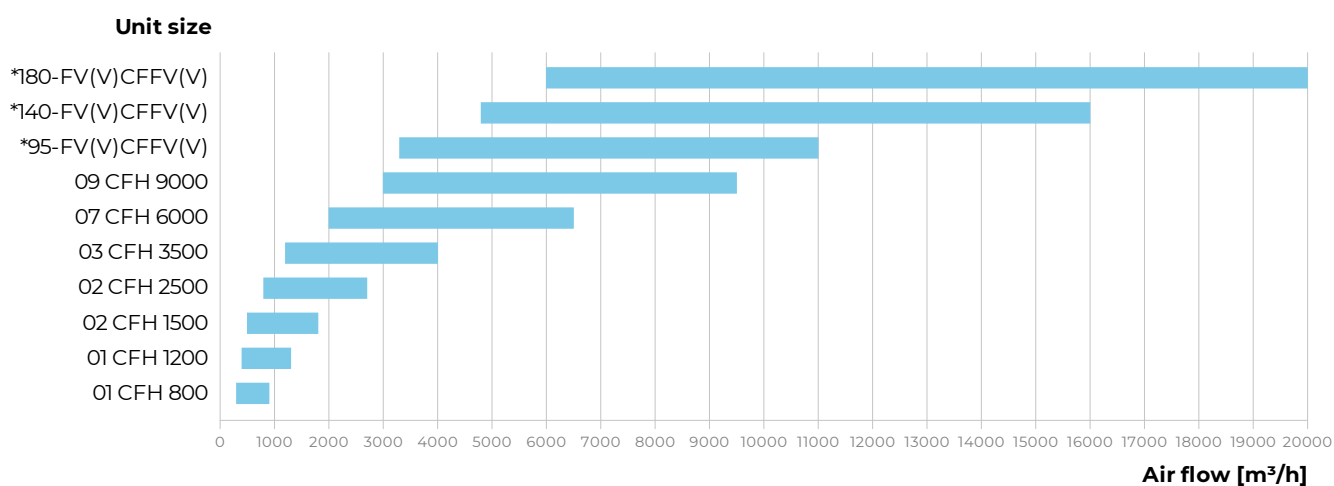

Connection dimensions [mm]

Unit size	01 CFH 800	01 CFH 1200	02 CFH 1500	02 CFH 2500	03 CFH 3500	07 CFH 6000	09 CFH 9000	*95-FV(V) CFFV(V)	*140-FV(V) CFFV(V)	*180-FV(V) CFFV(V)
Width × Height	Ø 315	Ø 315	600×350	600×350	700×400	1000×500	1200×600	1400×600	1800×800	2000×1000

* The units are available in BLS casing only.

BLAUAIR CFP

CEILING MOUNTED HEAT RECOVERY UNITS



FEATURES

High-efficient counterflow heat exchanger made of profiled polystyrene plates, packed with elastic heat-resistant sealant. Stainless steel drain pan on both supply and exhaust sides.

High-efficient EC fans, backward-curved, external rotor. Integrated plug-and-play controls.

Automatic bypass. ECO-Design'18 compliant. Polystyrene plate heat exchanger. Panel filters ePM1 70% (ISO 16890)-F7 (EN779). Removable service doors.

Web interface, MODBUS, outputs for optional electric/water heater or water/freon cooler..

Complete set of accessories: silencers, economizers, VAV, CAV, etc.

Operation by RH/CO₂/temperature/constant pressure/timer schedule.

Best suited for: small and medium-sized buildings, including residential blocks, educational facilities, offices, and retail spaces. Indoor installation.

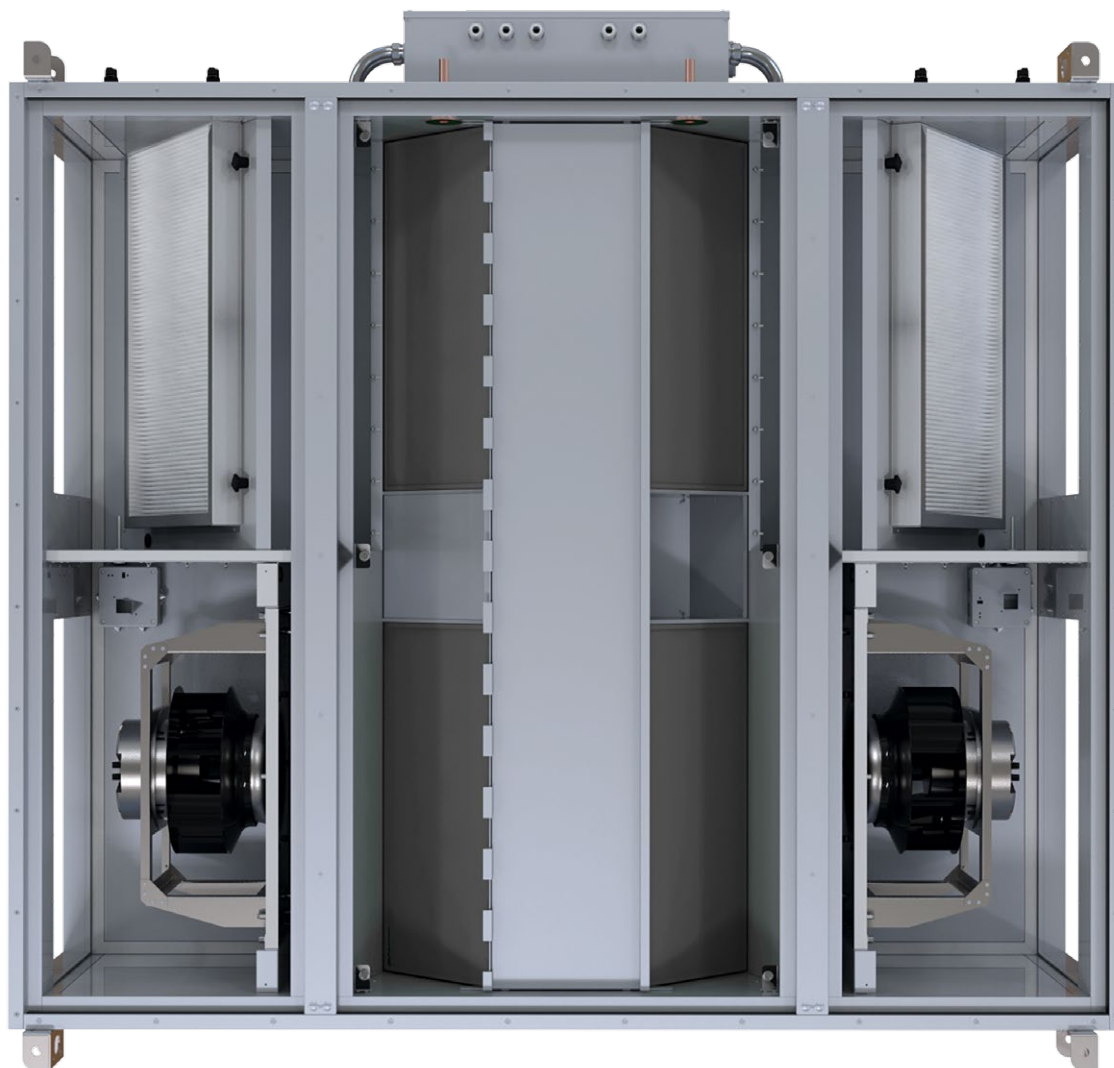

Sizes and capacities of BL and BLS Compact units

Unit size

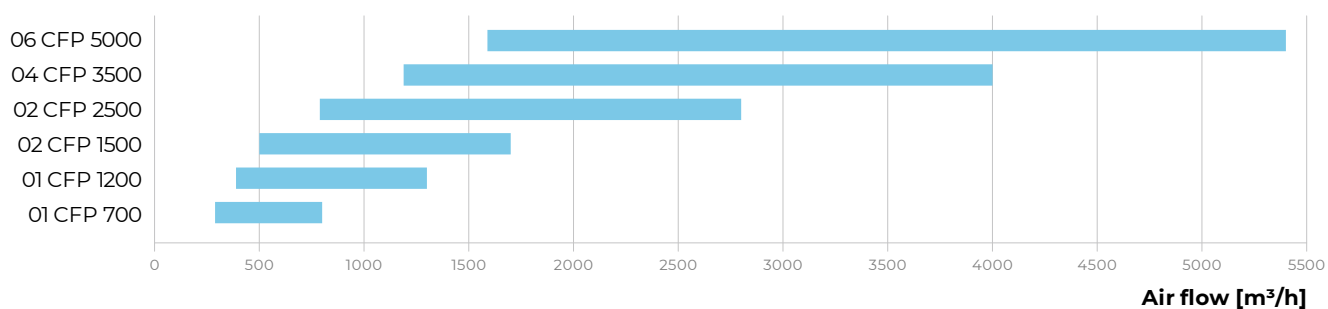

External pressure drop – 200 Pa

Connection dimensions [mm]

Unit size	01 CFP 700	01 CFP 1200	02 CFP 1500	02 CFP 2500	04 CFP 3500	06 CFP 5000
Width × Height	Ø 250	500×300	600×350	600×350	700×400	900×500

BLAUAIR CFV

FLOOR MOUNTED HEAT RECOVERY UNITS



FEATURES

High-efficient counterflow heat exchanger made of profiled polystyrene plates, packed with elastic heat-resistant sealant. Stainless steel drain pan on both supply and exhaust sides.

High-efficient EC fans, backward-curved, external rotor. Integrated plug-and-play controls.

Automatic bypass. ECO-Design'18 compliant. Polystyrene plate heat exchanger. Panel filters ePM1 70% (ISO 16890)-F7 (EN779). Hinged service doors.



Web interface, MODBUS, outputs for optional water/freon cooler or electric/water heater.

Complete set of accessories: silencers, economizers, VAV, CAV, etc.

Operation by RH/CO₂/temperature/constant pressure/timer schedule.

Best suited for: applications in residential, commercial, and public buildings where outdoor installation is not feasible, including offices, educational institutions, and facilities with restricted installation space. Designed for indoor installation.



Sizes and capacities of BL and BLS Compact units

Unit size

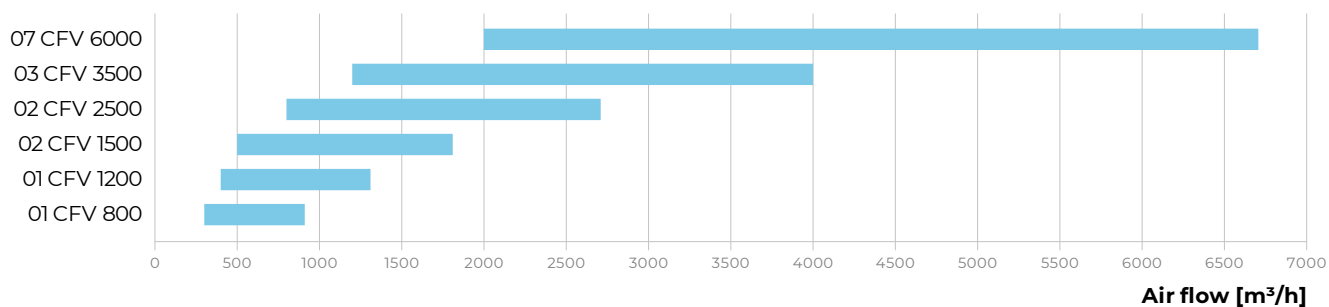

Connection dimensions [mm]

Unit size	01 CFV 800	01 CFV 1200	02 CFV 1500	02 CFV 2500	03 CFV 3500	07 CFV 6000
Width × Height	Ø 315	Ø 315	600×300	600×300	600×300	1000×400

BLAUAIR RH

FLOOR MOUNTED HEAT RECOVERY UNITS



FEATURES

High-efficiency rotary heat exchanger available in two types: condensing (aluminium) and enthalpy.

High-efficient EC fans, backward-curved, external rotor. Integrated plug-and-play controls.

Web interface, MODBUS, outputs for optional electric/water heater or water/freon cooler.

Complete set of accessories: silencers, economizers, VAV, CAV, etc.

Operation by RH/CO₂/temperature/constant pressure/timer schedule.

Best suited for: a broad range of applications, from private residential buildings to large commercial and public facilities, including offices, educational institutions, public buildings, and facilities with restricted indoor installation areas. Suitable for both indoor and outdoor installation. Outdoor installation available with an optional mounting kit.

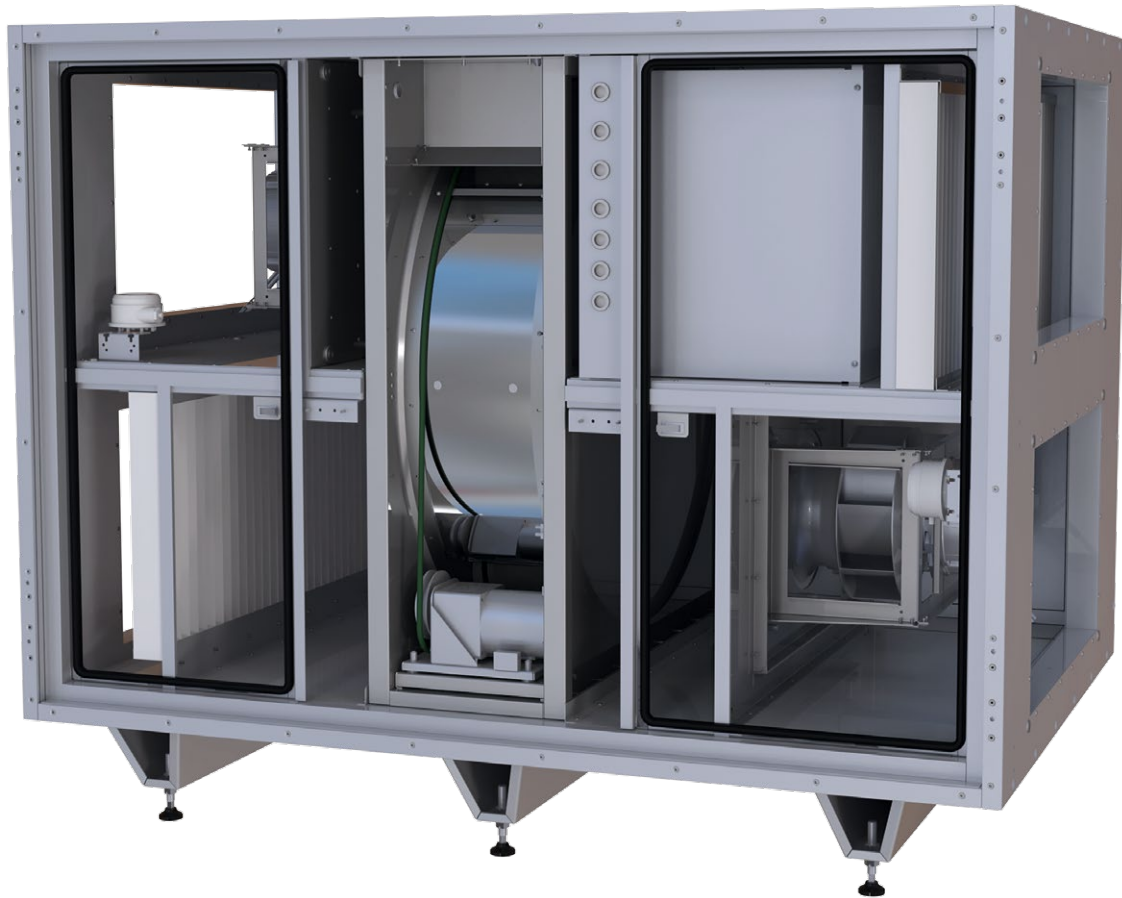

Sizes and capacities of BL and BLS Compact units

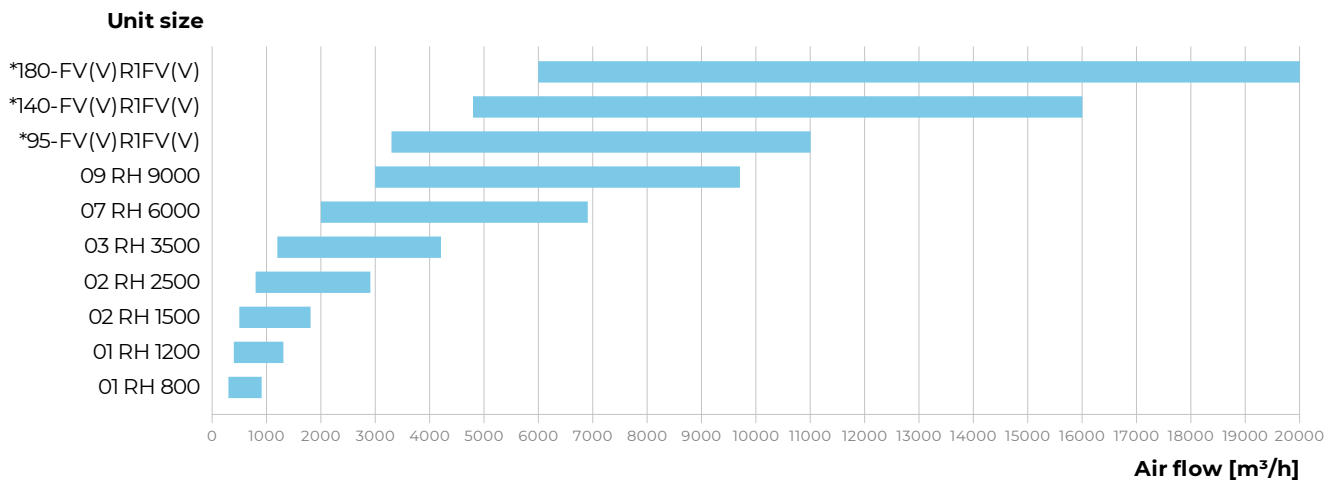

External pressure drop – 200 Pa

Connection dimensions [mm]

Unit size	01 RH 800	01 RH 1200	02 RH 1500	02 RH 2500	03 RH 3500	07 RH 6000	09 RH 9000	*95-FV(V)R1FV(V)	*140-FV(V)R1FV(V)	*180-FV(V)R1FV(V)
Width × Height	∅ 315	∅ 315	600×350	600×350	700×400	1000×500	1200×600	1400×600	1800×800	2000×1000

* The units are available in BLS casing only.

BLAUAIR RP

CEILING MOUNTED HEAT RECOVERY UNITS

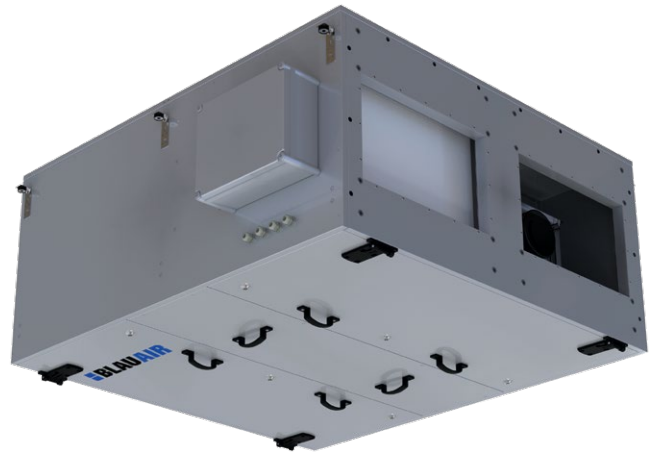

FEATURES

High-efficiency rotary heat exchanger available in two types: condensing (aluminium) and enthalpy.

High-efficient EC fans, backward-curved, external rotor. Integrated plug-and-play controls.

Web interface, MODBUS, outputs for optional electric/water heater or water/freon cooler.

Complete set of accessories: silencers, economizers, VAV, CAV, etc.

Operation by RH/CO₂/temperature/constant pressure/timer schedule.

Best suited for: light commercial buildings, educational facilities, offices, and retail spaces. Indoor installation.

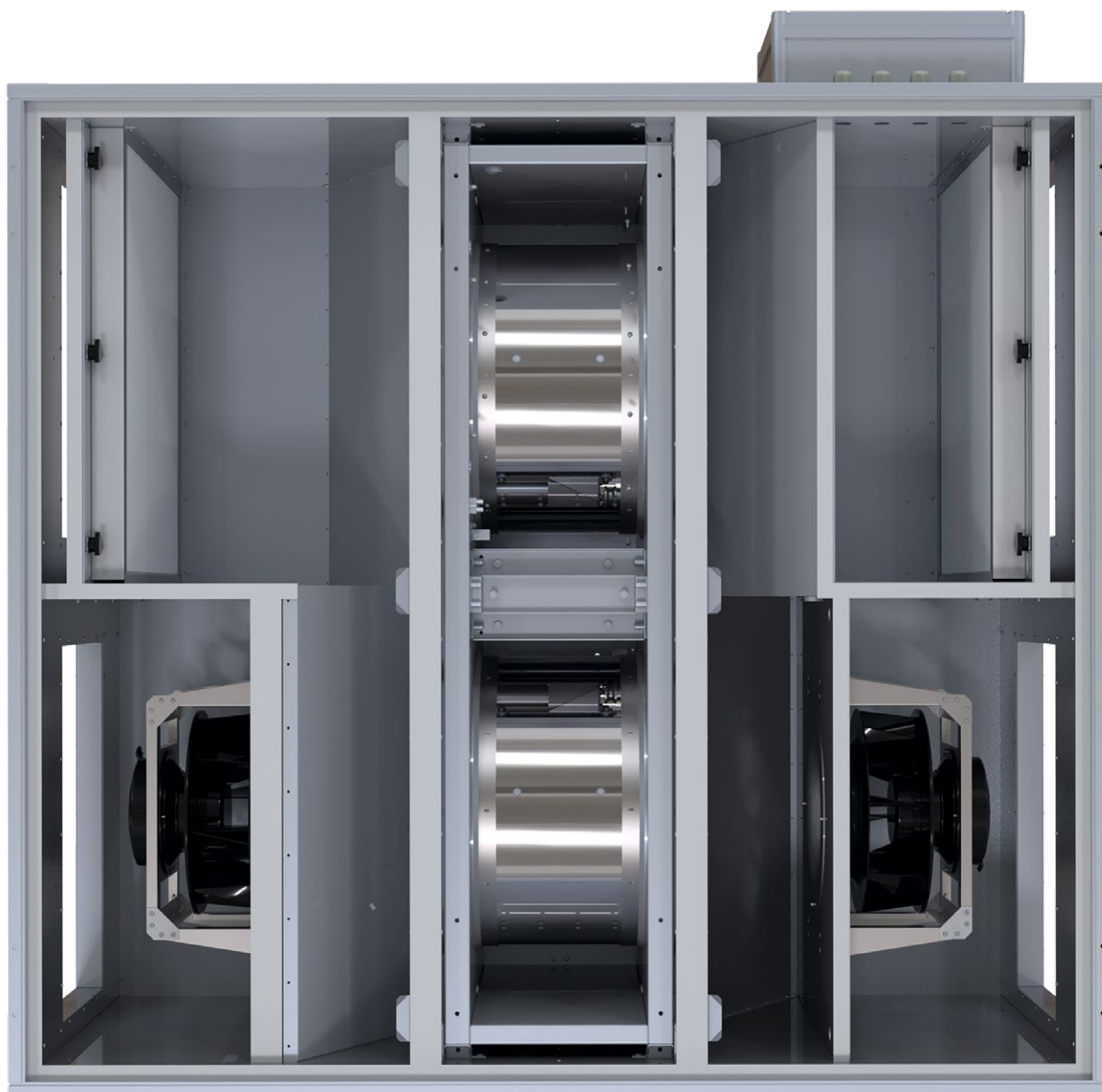

Sizes and capacities of BL and BLS Compact units

Unit size

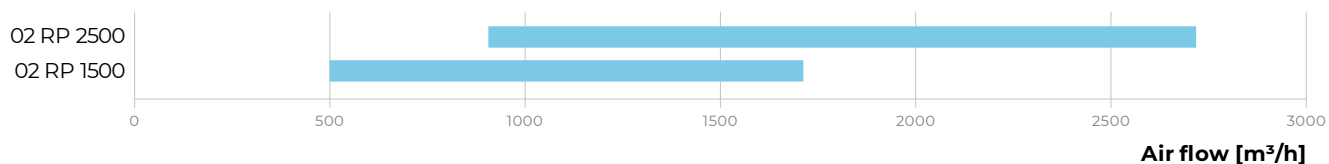

External pressure drop – 200 Pa

Connection dimensions [mm]

Unit size	02 RP 1500	02 RP 2500
Width × Height	500×300	500×300

BLAUAIR RV

FLOOR MOUNTED HEAT RECOVERY UNITS



FEATURES

High-efficiency rotary heat exchanger available in two types: condensing (aluminium) and enthalpy.

High-efficient EC fans, backward-curved, external rotor. Integrated plug-and-play controls.

Web interface, MODBUS, outputs for optional electric/water heater or water/freon cooler.

Complete set of accessories: silencers, economizers, VAV, CAV, etc.

Operation by RH/CO₂/temperature/constant pressure/timer schedule.

Best suited for: applications in residential, commercial, and public buildings where outdoor installation is not feasible, including offices, educational institutions, and facilities with restricted installation space. Designed for indoor installation.



Sizes and capacities of BL and BLS Compact units

Unit size

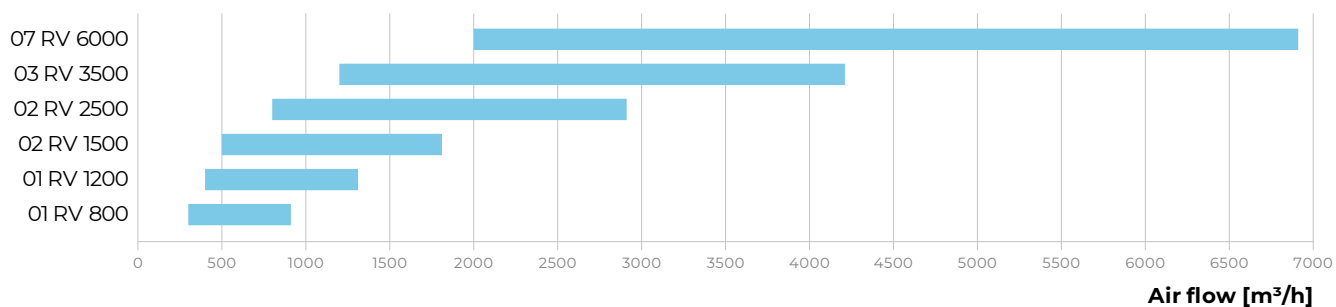

Connection dimensions [mm]

Unit size	01 RV 800	01 RV 1200	02 RV 1500	02 RV 2500	03 RV 3500	07 RV 6000
Width × Height	Ø 250	Ø 250	500×250	500×250	600×300	1000×350



S37 AUTOMATION



Control and automation

The **BlauAir S37** units are equipped with an integrated automation system. The remote control panel is not included in the delivery set (sold separately).

The S37 controller allows integrating the unit into the **BMS system (Building Management System)**.

The unit can be controlled by the **Blauberg AHU** mobile application via Wi-Fi.



Functions	
Unit control via Wi-Fi using a mobile application	+
Unit control via an extended remote control panel (pGNE) for full engineering adjustment	 S32 control panel (option)
Unit control via a touchscreen remote control panel (pGDxTouch 4.3") for full engineering adjustment	 S29 control panel (option)
Unit control via a simple remote control panel (th-Tune) with basic setting options and a user-friendly interface	 S30 control panel (option)
BMS (Building Management System)	RS-485
	BACnet IP, BACnet MSTP (option)
	Ethernet
	MODBUS (RTU, TCP)
Blauberg Cloud Server service	+
Speed selection	+
Filter replacement indication	by filter timer
	by filter clogging differential pressure switch
Alarm indication	full alarm description
Week-scheduled operation	+
Bypass	automatic
	manual
Timer	+
Freeze protection	through cyclic stops of the supply fan
	through preheating (option)
Reheater connection	option
Cooler connection	option
Minimum supply air temperature control	+
Humidity control	option
CO ₂ control	option
VOC control	option
PM2.5 control	option
Fire alarm sensor connection	option
CAV/VAV control option	option

Selection program of BlauAir Compact Units

Easy selection in all browsers

Data export to PDF and Excel

All selections could be saved in the Dashboard

Share your project with your manager in a few steps

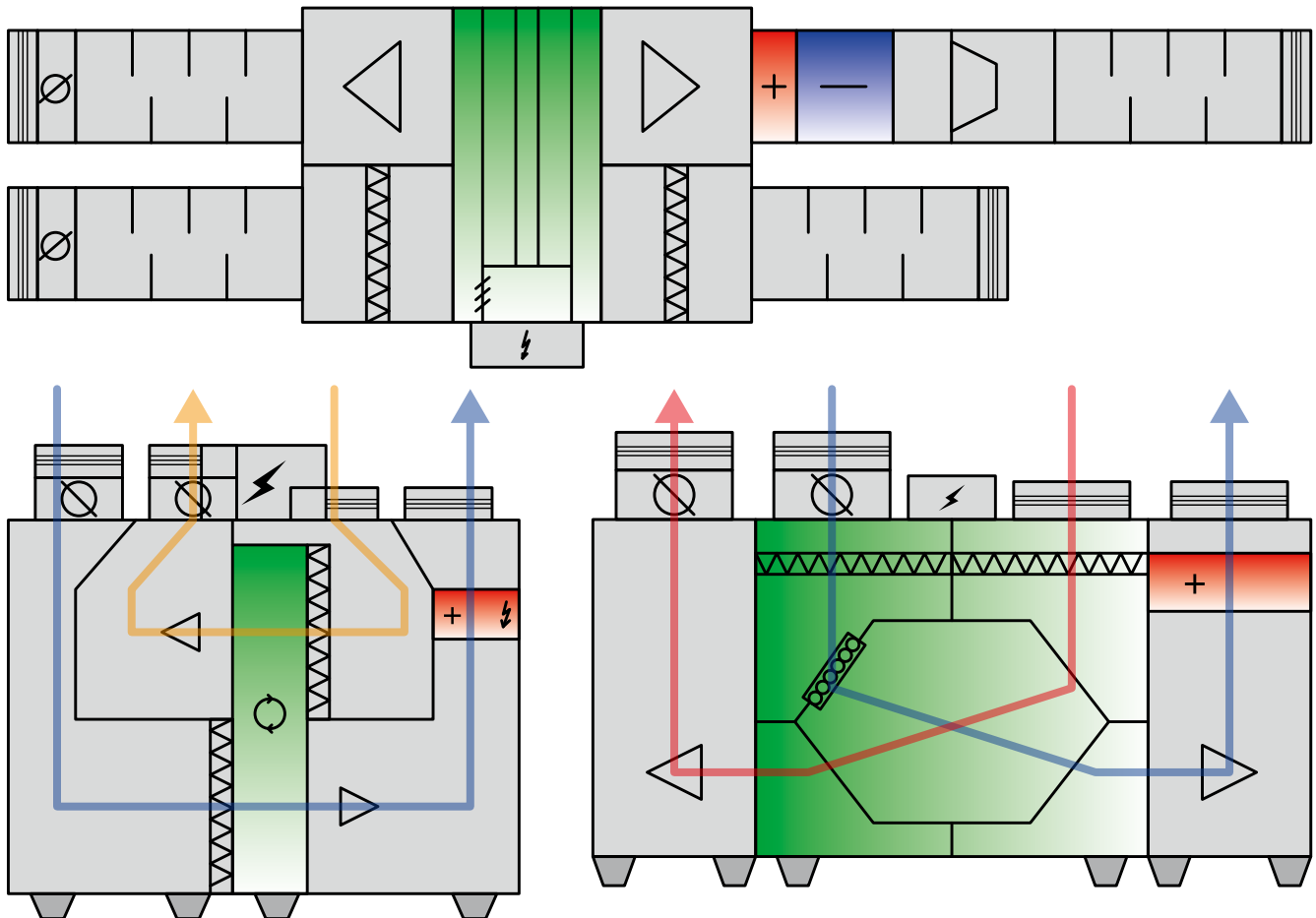



Select the unit online in a few clicks
and get full technical data at
blaubergselector.com



sales@blaubergventilatoren.net
<https://blaubergventilatoren.net>

Blauberg Ventilatoren GmbH
Stäblistraße 6
81477 Munich, Germany
HRB 203341
info@blaubergventilatoren.net

Technical changes reserved.
Illustrations and texts are non-binding.

3|2026

