



# AIR HANDLING UNITS



# CONTENTS

## Compact heat recovery air handling units



KOMFORT Ultra EC S2 300 4



KOMFORT Ultra EC L2 300 8



KOMFORT Ultra S 250 12



KOMFORT Ultra L 250 16



KOMFORT Ultra D 105 20

## Heat recovery air handling units in EPP casing



RENEO-FIT D 100 S14 24



RENEO D 28

## Heat recovery air handling units



KOMFORT EC SB 34



KOMFORT EC DB 44

## Heat recovery air handling units



KOMFORT ERV EC DB 50



KOMFORT ERV D S20 54



KOMFORT ERV D S3/S4 58



KOMFORT EC DBE 62



KOMFORT EC DBW 70



KOMFORT EC LB(E) 80

## Air handling units with rotary heat exchanger



KOMFORT Roto EC SKE 200 88



KOMFORT Roto EC SE 92



KOMFORT Roto EC LE/LW 100

**Air handling units with rotary heat exchanger**



KOMFORT Roto EC DE S21 110

**Supply ventilation units**



BLAUBOX EC ME 118



BLAUBOX EC MW 126



BLAUBOX DE PRO 136



BLAUBOX DW PRO 140

**Heaters**



EVH S21 V.2 146



ENH S21 V.2 148

**Silencers**



SD 150



SD 152

**Air dampers**



VK 154



VKA 155



VRV 156



VK 157



AVK 158





VRVS 159





SL 160

# CONTENTS

## Clamps

	KZ	162
	KZH	163



## Control panels

	S22 / S22 Wi-Fi	171
	S25	172

## Speed controllers

	SGR-3/1	164
	CDP-2/5 (3/5)	165
	CDT E1.8	166
	CDT E/0-10	167
	CDTE E1.8	168
	CDTE E/0-10	169
	CDT1 E	170

## Sensors

	CD-1 / CD-2	173
	HR-S	174
	FS2	175

## Electric actuators

	BELIMO TF230 / TF24	176
---	---------------------	-----

## Condensate drainage

	SFK 20x32	177
--	-----------	-----

# KOMFORT ULTRA EC S2 300

Compact heat recovery air handling units

## Features

- Air handling units for efficient supply and exhaust ventilation in flats, houses, cottages and other buildings.
- The heat recovery technology is used to minimize ventilation heat losses.
- Control of air exchange for creating comfortable indoor microclimate.
- Compatible with round Ø 125 mm air ducts.



**Air flow:**  
up to 300 m<sup>3</sup>/h  
83 l/s



**Heat recovery efficiency:**  
up to 79 %



## Design

- The casing of **KOMFORT Ultra EC S2 300 ... white** is made of double-skinned white painted metal panels, internally filled with 20 mm mineral wool layer for heat- and sound-insulation.
- The spigots are located at the top of the unit and are rubber sealed for airtight connection to the air ducts.
- The hinged panel of the casing ensures easy access to the unit internals for service works including cleaning, filter replacement, etc.

## Fans

- The unit is equipped with high-efficient external rotor EC motors and centrifugal impellers with forward curved blades.
- EC motors have the best power consumption to air flow ratio and meet the latest demands concerning energy saving and high-efficient ventilation.
- EC motors are featured with high performance, low noise level and totally controllable speed range.
- The impellers are dynamically balanced.

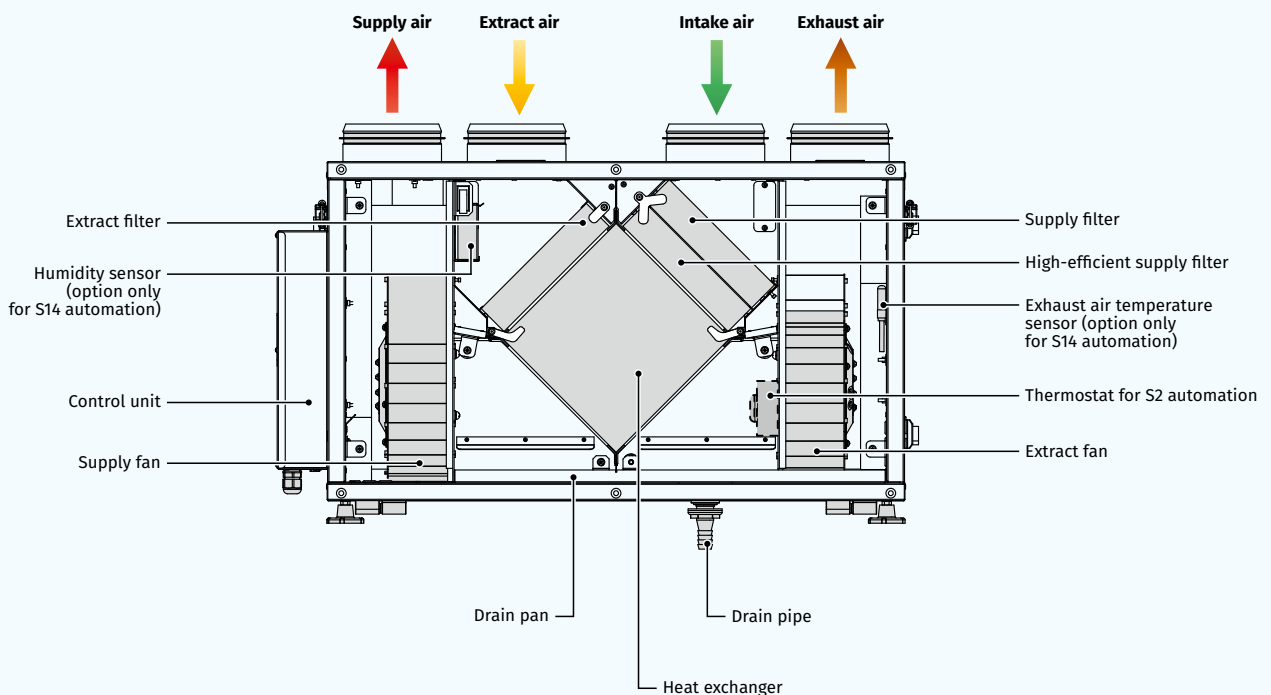

### Heat recovery

o The **KOMFORT Ultra EC S2 300-H ... white** unit is equipped with a plate cross-flow polystyrene heat exchanger for heat recovery. The unit condensate is collected and drained to the drain pan under the heat exchanger.

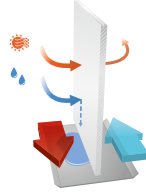

o The **KOMFORT Ultra EC S2 300-E ... white** unit is equipped with an enthalpy plate cross-flow heat exchanger for energy (heat and humidity) recovery. Due to humidity recovery condensate is not generated in the enthalpy heat exchanger.



- o The air flows are completely separated in the heat exchanger. Thus smells and contaminants are not transferred from the extract air to the supply air.
- o Heat recovery is based on heat and/or humidity transfer through the heat exchanger plates. In the cold season supply air is heated in the heat exchanger by transferring the heat energy of warm and humid extract air to the cold fresh air. Heat recovery minimizes ventilation heat losses and heating costs respectively.
- o In the warm season the heat exchanger performs reverse and intake air is cooled in the heat exchanger by the cool extract air. That reduces operation load on air conditioners and saves electricity.
- o When the indoor and outdoor temperature difference is insignificant, heat recovery is not reasonable. In this case the heat exchanger can be temporary replaced with a summer block for the warm season (available as a specially ordered accessory).

### FREEZE PROTECTION

- o The integrated automatic freeze protection is used to prevent freezing of the heat exchanger in the cold season. The supply fan turns off according to the temperature sensor to get the heat exchanger warmed up with extract air. After that the supply fan turns on and the unit continues to run in the standard mode.

### Air filtration

- o Two built-in G4 and F8 filters provide efficient supply air filtration.
- o The G4 filter is used for extract air filtration.

### Control and automation

o The **KOMFORT Ultra EC S2 300-H(E) S2 white** unit is equipped with the CDT E/0-10 speed controller that is included in the delivery.



o The **KOMFORT Ultra EC S2 300-H(E) S14 white** units have an integrated control system with a wall-mounted control panel S14 with a LED indication.



#### The S14 control panel functions:

- Unit On/Off.
- Speed selection: Low, Medium or High.
- Activation of the summer ventilation mode: The supply fan stops and the extract fan continues its operation with no heat recovery.

- Alarm indication.
- Filter maintenance indication.

**The KOMFORT Ultra EC S2 300-H(E) S14 white unit is equipped with a USB connector (Type B) and can be connected to a PC for configuring the advanced settings in a special software:**

- Fan speed adjustment from 0 to 100 %. Each speed is individually adjusted for the supply and the extract fans.
- Operation control on feedback from the FS2 duct humidity sensor (to be ordered separately).
- Unit operation setting according to the external relay (to be ordered separately).
- Temperature setting for freeze protection system activation.
- Control and operation adjustment of the filter maintenance timer.
- External control unit and humidity level control.
- Software version upgrading.

### Mounting

- o The units can be fixed to the wall or mounted on the floor using the mounting brackets. The **KOMFORT Ultra EC S2 300-E ... white** unit is also suitable for ceiling mounting.
- o The **KOMFORT Ultra EC S2 300-H ... white** unit mounting position must provide condensate collection and drainage.
- o While mounting provide free access to the service panel for filter replacement and servicing.
- o Due to universal casing design both left and right mounting is possible. It requires swapping the service and the back panel.

### Designation key

Series	Unit type	Motor type	Spigot modification	Insulation	Rated air flow [m³/h]	Heat exchanger type	Control	Casing
KOMFORT	<b>Ultra:</b> compact unit	<b>EC:</b> electronically commutated motor	<b>S:</b> vertical spigot orientation	<b>2:</b> insulation 20 mm	<b>300</b>	<b>H:</b> heat recovery <b>E:</b> energy recovery	<b>S2:</b> CDT E/0-10 speed controller <b>S14:</b> sensor control panel with LED indication	<b>white:</b> painted steel

### Overall dimensions [mm]

Model	D	B	H	H1	L	L1
KOMFORT Ultra EC S2 300-H(E) S2 white	125	300	443	490	713	43
KOMFORT Ultra EC S2 300-H(E) S14 white	125	300	443	490	713	63

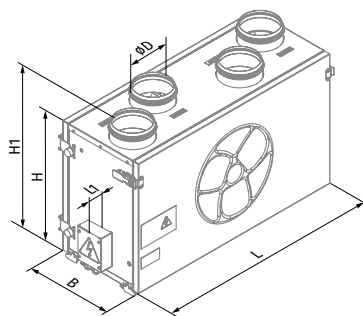

KOMFORT Ultra EC S2 300-H(E) S2 white

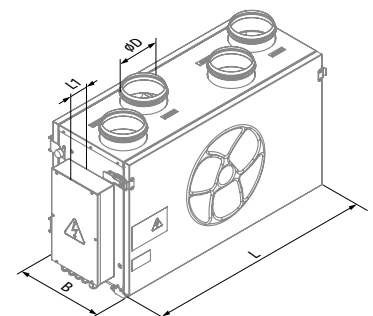

KOMFORT Ultra EC S2 300-H(E) S14 white

**Technical data**

Parameters	KOMFORT Ultra EC S2 300-H S2 white KOMFORT Ultra EC S2 300-H S14 white	KOMFORT Ultra EC S2 300-E S2 white KOMFORT Ultra EC S2 300-E S14 white
Voltage [V / 50 (60) Hz]	1 ~ 230	1 ~ 230
Power [W]	165	165
Current [A]	1.3	1.3
Maximum air flow [m³/h (l/s)]	300 (83)	300 (83)
Sound pressure level at 3 m [dBA]	33	33
Transported air temperature [°C]	-25...+40	-25...+40
Insulation	20 mm mineral wool	20 mm mineral wool
Extract filter	G4	G4
Supply filter	G4, F8	G4, F8
Connected air duct diameter [mm]	125	125
Weight [kg]	32	28
Heat recovery efficiency [%]*	55-79	51-73
Humidity recovery efficiency [%]	-	26-45
Heat exchanger type	cross-flow	cross-flow
Heat exchanger material	polyesterene	enthalpy
SEC class for S2 automation	B	C
SEC class for S14 automation	A	A
ErP	2016, 2018	2016, 2018

\*Heat recovery efficiency is specified in compliance with the EN 13141-7.

Sound power level, A-weighted	Total	Octave frequency band [Hz]								LpA 3 m	LpA 1 m
		63	125	250	500	1000	2000	4000	8000		
L <sub>WA</sub> to supply inlet [dBA]	56	48	43	53	44	44	40	26	24		
L <sub>WA</sub> to supply outlet [dBA]	71	53	53	68	65	60	59	52	51		
L <sub>WA</sub> to exhaust inlet [dBA]	57	43	51	52	52	45	37	26	21		
L <sub>WA</sub> to exhaust outlet [dBA]	72	53	60	66	67	61	62	55	48		
L <sub>WA</sub> to environment [dBA]	53	33	44	47	50	44	38	29	24	33	43

Data provided for point 1 of the air flow diagram

Total power. Total sound pressure level.



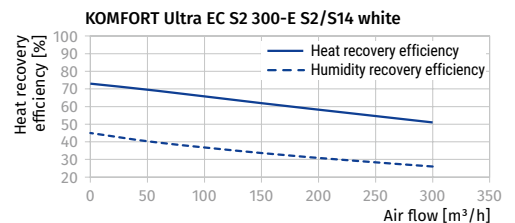
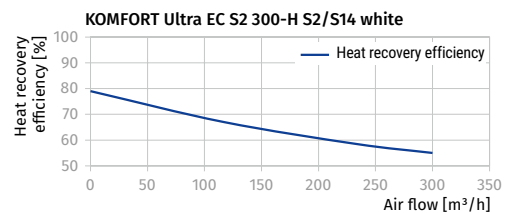
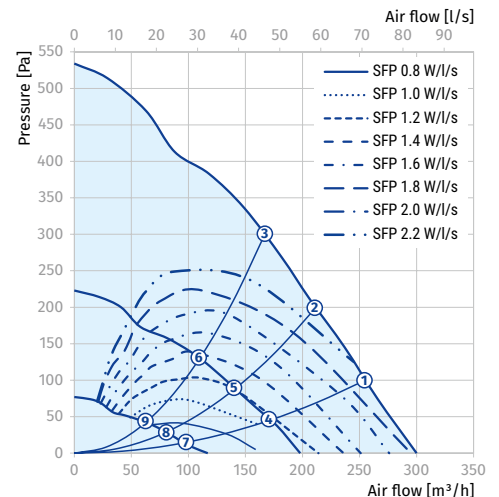







Point	Total power of the unit [W]	Sound pressure level at 3 m (1 m) [dBA]
1	150	33 (43)
2	138	33 (43)
3	121	32 (42)
4	52	31 (41)
5	48	28 (38)
6	41	27 (37)
7	17	27 (37)
8	16	23 (33)
9	14	23 (33)



COMPACT HEAT RECOVERY AIR HANDLING UNITS



**Accessories**

		KOMFORT Ultra EC S2 300-H S2 white KOMFORT Ultra EC S2 300-E S2 white	KOMFORT Ultra EC S2 300-H S14 white KOMFORT Ultra EC S2 300-E S14 white
G4 panel filter		FP 240x184x40 G4	FP 240x184x40 G4
F8 panel filter		FP 240x184x40 F8	FP 240x184x40 F8
Humidity sensor		-	FS2
CO <sub>2</sub> sensor with indication		-	CD-1
CO <sub>2</sub> sensor		-	CD-2
Humidity sensor		-	HR-S
Silencer		SD 125	SD 125
Backdraft air damper		VRV 125	VRV 125
Air damper		-	VKA 125
Electric actuator		-	TF230
Summer block		SB C4 200/240	SB C4 200/240

# KOMFORT ULTRA EC L2 300

## Compact heat recovery air handling units

### Features

- Air handling units for efficient supply and exhaust ventilation in flats, houses, cottages and other buildings.
- The heat recovery technology is used to minimize ventilation heat losses.
- Control of air exchange for creating comfortable indoor microclimate.
- Compatible with round Ø 125 mm air ducts.



**Air flow:**  
up to 300 m<sup>3</sup>/h  
83 l/s



**Heat recovery efficiency:**  
up to 79 %



### Design

- The casing of **KOMFORT Ultra EC L2 300 ... white** is made of double-skinned white painted metal panels, internally filled with 20 mm mineral wool layer for heat- and sound-insulation.
- The spigots are located at the sides of the unit and are equipped with rubber seals for airtight connection to the air ducts.
- The hinged panel of the casing ensures easy access to the unit internals for service works including cleaning, filter replacement, etc.

### Fans

- The unit is equipped with high-efficient external rotor EC motors and centrifugal impellers with forward curved blades.
- EC motors have the best power consumption to air flow ratio and meet the latest demands concerning energy saving and high-efficient ventilation.
- EC motors are featured with high performance, low noise level and totally controllable speed range.
- The impellers are dynamically balanced.

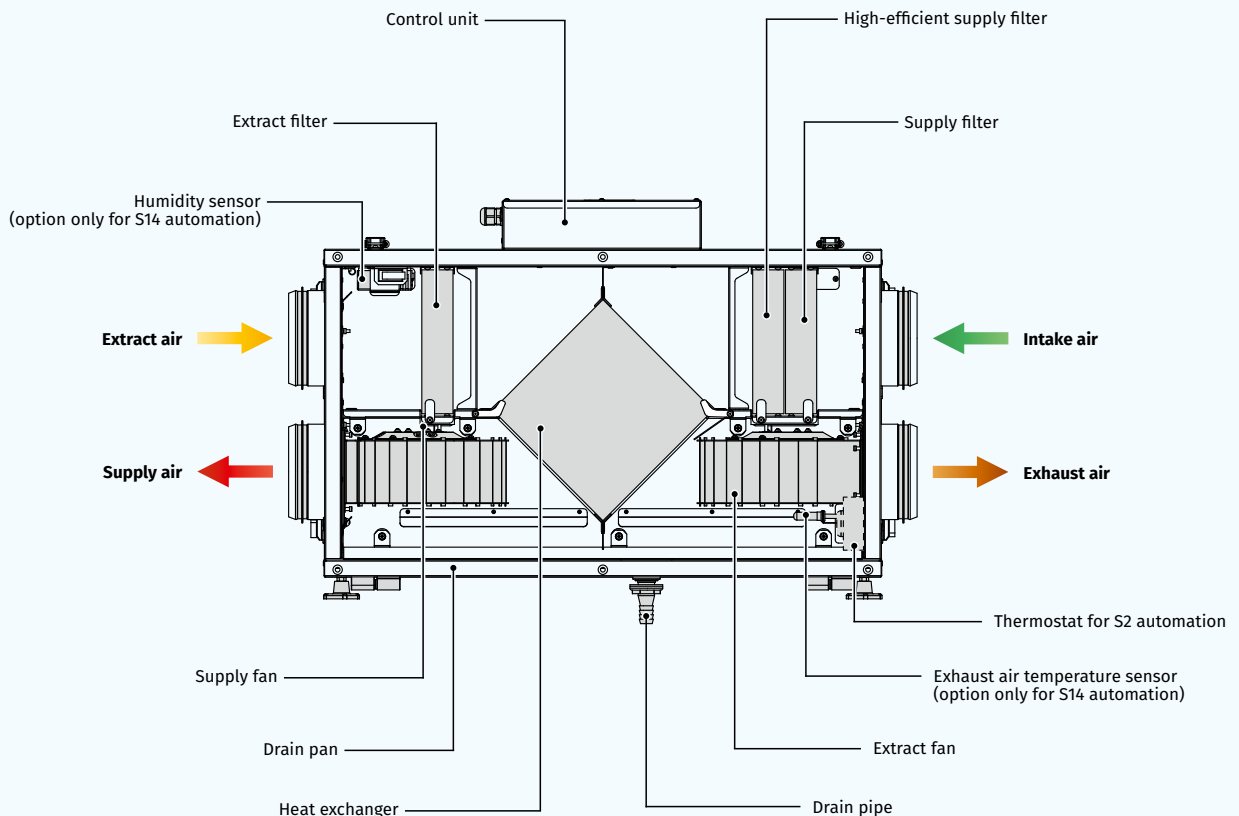

### Heat recovery

- The **KOMFORT Ultra EC L2 300-H ... white** unit is equipped with a plate cross-flow polystyrene heat exchanger for heat recovery. The unit condensate is collected and drained to the drain pan under the heat exchanger.
- The **KOMFORT Ultra EC L2 300-E ... white** unit is equipped with an enthalpy plate cross-flow heat exchanger for energy (heat and humidity) recovery. Due to humidity recovery condensate is not generated in the enthalpy heat exchanger.

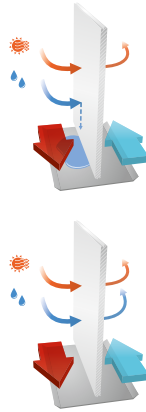

### Control and automation

- The **KOMFORT Ultra EC L2 300-H(E) S2 white** unit is equipped with the CDT E/0-10 speed controller that is included in the delivery.
- The **KOMFORT Ultra EC L2 300-H(E) S14 white** units have an integrated control system with a wall-mounted control panel S14 with a LED indication.



#### The S14 control panel functions:

- Unit On/Off.
- Speed selection: Low, Medium or High.
- Activation of the summer ventilation mode: The supply fan stops and the extract fan continues its operation with no heat recovery.
- Alarm indication.
- Filter maintenance indication.

#### The KOMFORT Ultra EC L2 300-H(E) S14 white unit is equipped with a USB connector (Type B) and can be connected to a PC for configuring the advanced settings in a special software:

- Fan speed adjustment from 0 to 100 %. Each speed is individually adjusted for the supply and the extract fans
- Operation control on feedback from the FS2 duct humidity sensor (to be ordered separately)
- Unit operation setting according to the external control unit (to be ordered separately)
- Temperature setting for freeze protection system activation
- Control and operation adjustment of the filter maintenance timer
- External relay status and humidity level control
- Software version upgrading

### Mounting

- The units can be fixed to the wall or mounted on the floor using the mounting brackets. The **KOMFORT Ultra EC L2 300-E ... white** unit is also suitable for ceiling mounting.
- The **KOMFORT Ultra EC L2 300-H ... white** unit mounting position must provide condensate collection and drainage.
- While mounting provide free access to the service panel for filter replacement and servicing.
- Due to universal casing design both left and right mounting is possible. It requires swapping the service and the back panel.

- The air flows are completely separated in the heat exchanger. Thus smells and contaminants are not transferred from the extract air to the supply air.
- Heat recovery is based on heat and/or humidity transfer through the heat exchanger plates. In the cold season supply air is heated in the heat exchanger by transferring the heat energy of warm and humid extract air to the cold fresh air. Heat recovery minimizes ventilation heat losses and heating costs respectively.
- In the warm season the heat exchanger performs reverse and intake air is cooled in the heat exchanger by the cool extract air. That reduces operation load on air conditioners and saves electricity.
- When the indoor and outdoor temperature difference is insignificant, heat recovery is not reasonable. In this case the heat exchanger can be temporary replaced with a summer block for the warm season (available as a specially ordered accessory).

### FREEZE PROTECTION

- The integrated automatic freeze protection is used to prevent freezing of the heat exchanger in the cold season. The supply fan turns off according to the temperature sensor to get the heat exchanger warmed up with extract air. After that the supply fan turns on and the unit continues to run in the standard mode.

### Air filtration

- Two built-in G4 and F8 filters provide efficient supply air filtration.
- The G4 filter is used for extract air filtration.

### Designation key

Series	Unit type	Motor type	Spigot modification	Insulation	Rated air flow [m³/h]	Heat exchanger type	Control	Casing
KOMFORT	<b>Ultra:</b> compact unit	<b>EC:</b> electronically commutated motor	<b>L:</b> horizontal spigot orientation	<b>2:</b> Insulation 20 mm	<b>300</b>	<b>H:</b> heat recovery <b>E:</b> energy recovery	<b>S2:</b> CDT E/0-10 speed controller <b>S14:</b> sensor control panel with LED indication	<b>white:</b> painted steel

### Overall dimensions [mm]

Model	D	B	H	H1	L	L1
KOMFORT Ultra EC L2 300-H(E) S2 white	125	287	447	43	714	810
KOMFORT Ultra EC L2 300-H(E) S14 white	125	287	447	43	714	810

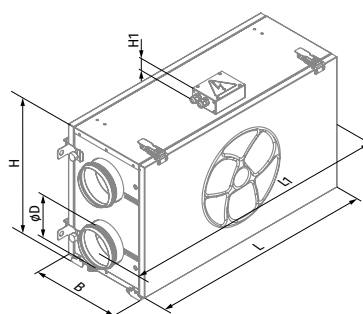

KOMFORT Ultra EC L2 300-H(E) S2 white

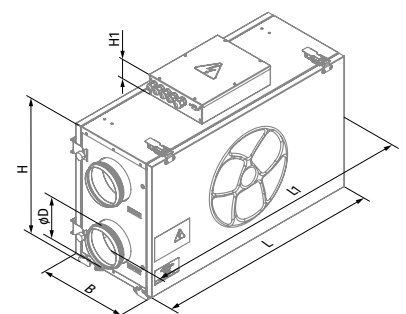

KOMFORT Ultra EC L2 300-H(E) S14 white

## Technical data

Parameters	KOMFORT Ultra EC L2 300-H S2 white KOMFORT Ultra EC L2 300-H S14 white	KOMFORT Ultra EC L2 300-E S2 white KOMFORT Ultra EC L2 300-E S14 white
Voltage [V / 50 (60) Hz]	1 ~ 230	1 ~ 230
Power [W]	165	165
Current [A]	1.3	1.3
Maximum air flow [m <sup>3</sup> /h (l/s)]	300 (83)	300 (83)
Sound pressure level at 3 m [dBA]	33	33
Transported air temperature [°C]	-25...+40	-25...+40
Insulation	20 mm mineral wool	20 mm mineral wool
Extract filter	G4	G4
Supply filter	G4, F8	G4, F8
Connected air duct diameter [mm]	125	125
Weight [kg]	32	28
Heat recovery efficiency [%]*	55-79	51-73
Humidity recovery efficiency [%]	-	26-45
Heat exchanger type	cross-flow	cross-flow
Heat exchanger material	polyesterene	enthalpy
SEC class for S2 automation	B	C
SEC class for S14 automation	A	A
ErP	2016, 2018	2016, 2018

\*Heat recovery efficiency is specified in compliance with the EN 13141-7.

Sound power level, A-weighted	Total	Octave frequency band [Hz]								LpA 3 m	LpA 1 m
		63	125	250	500	1000	2000	4000	8000		
L <sub>WA</sub> to supply inlet [dBA]	56	48	43	53	44	44	40	26	24		
L <sub>WA</sub> to supply outlet [dBA]	71	53	53	68	65	60	59	52	51		
L <sub>WA</sub> to exhaust inlet [dBA]	57	43	51	52	52	45	37	26	21		
L <sub>WA</sub> to exhaust outlet [dBA]	72	53	60	66	67	61	62	55	48		
L <sub>WA</sub> to environment [dBA]	53	33	44	47	50	44	38	29	24	33	43







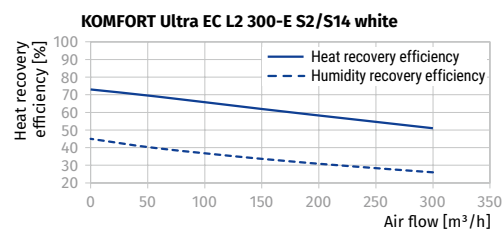
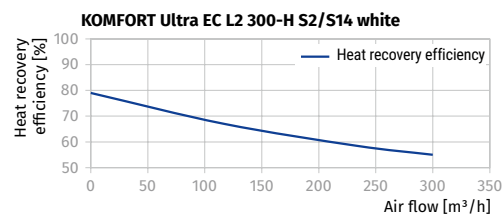
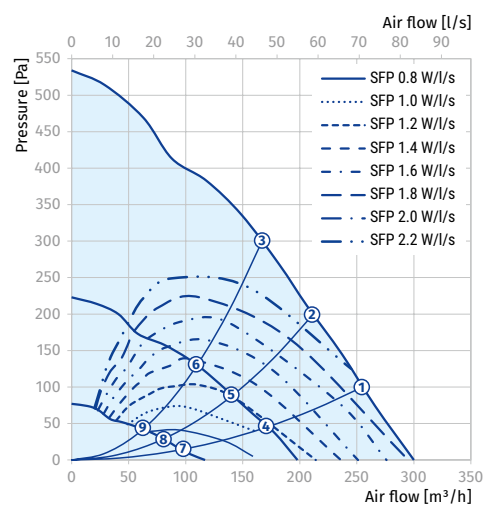



Data provided for point 1 of the air flow diagram

Total power. Total sound pressure level.

Point	Total power of the unit [W]	Sound pressure level at 3 m (1 m) [dBA]
1	150	33 (43)
2	138	33 (43)
3	121	32 (42)
4	52	31 (41)
5	48	28 (38)
6	41	27 (37)
7	17	27 (37)
8	16	23 (33)
9	14	23 (33)



**Accessories**

		KOMFORT Ultra EC L2 300-H S2 white KOMFORT Ultra EC L2 300-E S2 white	KOMFORT Ultra EC L2 300-H S14 white KOMFORT Ultra EC L2 300-E S14 white
G4 panel filter		FP 240x184x40 G4	FP 240x184x40 G4
F8 panel filter		FP 240x184x40 F8	FP 240x184x40 F8
Humidity sensor		-	FS2
CO <sub>2</sub> sensor with indication		-	CD-1
CO <sub>2</sub> sensor		-	CD-2
Humidity sensor		-	HR-S
Silencer		SD 125	SD 125
Backdraft air damper		VRV 125	VRV 125
Air damper		-	VKA 125
Electric actuator		-	TF230
Summer block		SB C4 200/240	SB C4 200/240

# KOMFORT ULTRA S 250

## Compact heat recovery air handling units

### Features

- Air handling units for efficient supply and exhaust ventilation in flats, houses, cottages and other buildings.
- Heat and humidity recovery reduces ventilation heat losses in the cold season and the load on the air conditioners in the hot season.
- Control of air exchange for creating comfortable indoor microclimate.
- Compatible with round Ø 125 mm air ducts.



**Air flow:**  
up to 250 m<sup>3</sup>/h  
69 l/s



**Heat recovery efficiency:**  
up to 78 %



### Design

- The casing of **KOMFORT Ultra S 250-H(E)** is made of double-skinned aluzinc panels, internally filled with 20 mm mineral wool layer for heat- and sound-insulation.
- The casing of **KOMFORT Ultra S 250-H(E) white** is made of double-skinned white painted metal panels, internally filled with 20 mm mineral wool layer for heat and sound insulation.
- The spigots are located at the top of the unit and are rubber sealed for airtight connection to the air ducts.
- The hinged panel of the casing ensures easy access to the unit internals for service works including cleaning, filter replacement, etc.

### Fans

- Asynchronous external rotor motors and centrifugal impellers with backward curved blades are used for air supply and exhaust.
- Integrated motor overheating protection with automatic restart.
- Dynamically balanced impellers.
- Equipped with ball bearings for longer service life.
- Reliable and quiet operation.

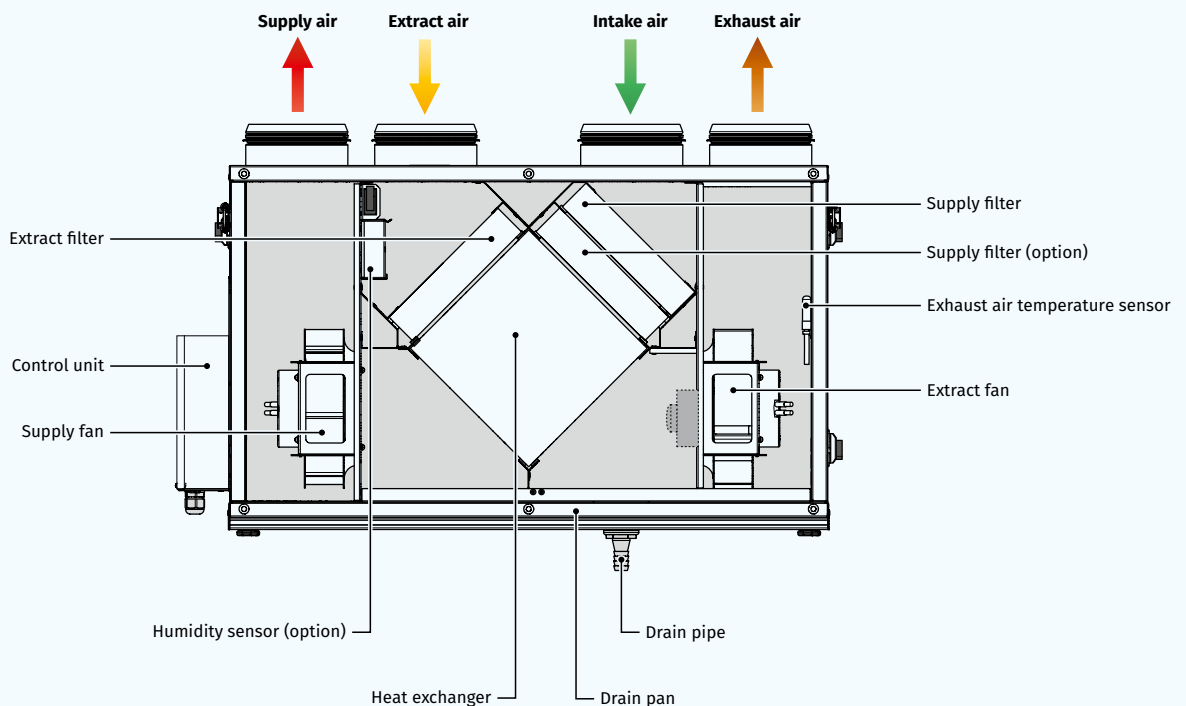

COMPACT HEAT RECOVERY AIR HANDLING UNITS

### Heat recovery

The **KOMFORT Ultra S 250-H (white)** unit is equipped with a plate cross-flow polystyrene heat exchanger for heat recovery. The unit condensate is collected and drained to the drain pan under the heat exchanger.



The **KOMFORT Ultra S 250-E (white)** unit is equipped with an enthalpy plate cross-flow heat exchanger for energy (heat and humidity) recovery. Due to humidity recovery condensate is not generated in the enthalpy heat exchanger.



- The air flows are completely separated in the heat exchanger. Thus smells and contaminants are not transferred from the extract air to the supply air.
- Heat recovery is based on heat and/or humidity transfer through the heat exchanger plates. In the cold season supply air is heated in the heat exchanger by transferring the heat energy of warm and humid extract air to the cold fresh air. Heat recovery minimizes ventilation heat losses and heating costs respectively.
- In the warm season the heat exchanger performs reverse and intake air is cooled in the heat exchanger by the cool extract air. That reduces operation load on air conditioners and saves electricity.
- When the indoor and outdoor temperature difference is insignificant, heat recovery is not reasonable. In this case the heat exchanger can be temporary replaced with a summer block for the warm season (available as a specially ordered accessory).

### FREEZE PROTECTION

- The integrated automatic freeze protection is used to prevent freezing of the heat exchanger in the cold season. The supply fan turns off according to the temperature sensor to get the heat exchanger warmed up with extract air. After that the supply fan turns on and the unit continues to run in the standard mode.

### Designation key

Series	Unit type	Spigot modification	Rated air flow [m³/h]	Heat exchanger type	Control	Casing
KOMFORT	<b>Ultra:</b> compact unit	<b>S:</b> vertical spigot orientation	<b>250</b>	- <b>H:</b> heat recovery <b>E:</b> energy recovery	<b>S1:</b> speed controller CDT	-: aluzinc <b>white:</b> white-painted steel

### Overall dimensions [mm]

Model	D	B	H	H1	L	L1
KOMFORT Ultra S 250-H(E) (white)	125	300	443	490	713	43

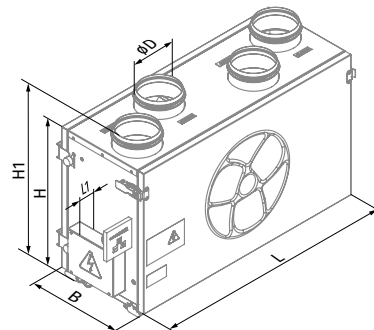

### Air filtration

- The built-in G4 supply filter and G4 extract filter provide air filtration.
- The F8 supply filter (specially ordered accessory) may be used for efficient supply air filtration.

### Control and automation

- Smooth motor speed control from 0 up to 100 % by means of the thyristor speed controller SGS E1 (included in the delivery).

### Mounting

- The units can be fixed to the wall or mounted on the floor using the mounting brackets. The **KOMFORT Ultra S 250-E (white)** unit is also suitable for ceiling mounting.
- While mounting provide free access to the service panel for filter replacement and servicing.
- The **KOMFORT Ultra S 250-H (white)** unit mounting position must provide condensate collection and drainage.
- Due to universal casing design both left and right mounting is possible. It requires swapping the service and the back panel.

## Technical data

Parameters	KOMFORT Ultra S 250-H S1 KOMFORT Ultra S 250-H S1 white	KOMFORT Ultra S 250-E S1 KOMFORT Ultra S 250-E S1 white
Voltage [V / 50 (60) Hz]	1 ~ 230	1 ~ 230
Power [W]	148	148
Current [A]	0.78	0.78
Maximum air flow [m <sup>3</sup> /h (l/s)]	250 (69)	250 (69)
Sound pressure level at 3 m [dBA]	28-47	28-47
Transported air temperature [°C]	-25...+40	-25...+40
Insulation	20 mm mineral wool	20 mm mineral wool
Extract filter	G4	G4
Supply filter	G4 (option: F8 PM2.5 > 81 %)	G4 (option: F8 PM2.5 > 81 %)
Connected air duct diameter [mm]	125	125
Heat recovery efficiency [%]	55-78	52-73
Humidity recovery efficiency [%]	-	27-45
Heat exchanger type	cross-flow	cross-flow
Heat exchanger material	polysterene	enthalpy
SEC class	E	E
ErP	2016	2016

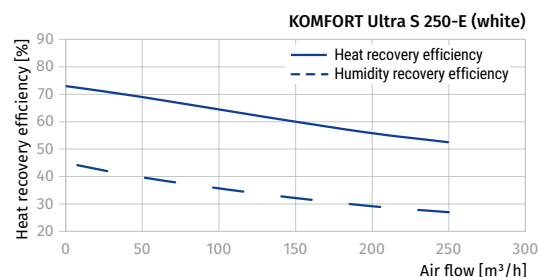
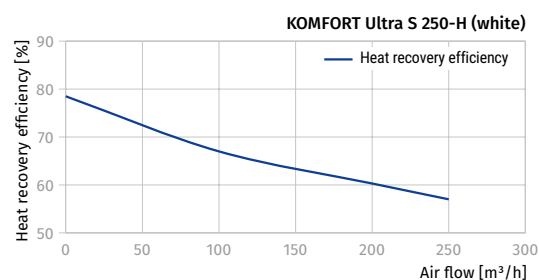
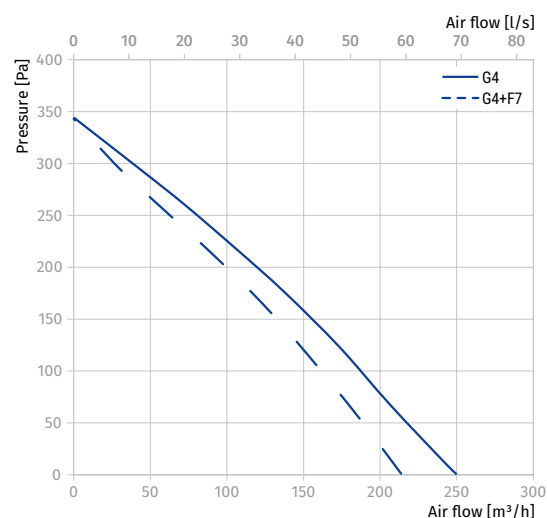



## Accessories

		KOMFORT Ultra S 250-H S1 KOMFORT Ultra S 250-H S1 white	KOMFORT Ultra S 250-E S1 KOMFORT Ultra S 250-E S1 white
G4 panel filter		FP 240x184x40 G4	FP 240x184x40 G4
F8 panel filter		FP 240x184x40 F8	FP 240x184x40 F8
Silencer		SD 125	SD 125
Backdraft air damper		VRV 125	VRV 125
Air damper		VK 125	VK 125
Summer block		SB C4 200/240	SB C4 200/240

# KOMFORT ULTRA L 250

## Compact heat recovery air handling units

### Features

- Air handling units for efficient supply and exhaust ventilation in flats, houses, cottages and other buildings.
- Heat and humidity recovery reduces ventilation heat losses in the cold season and the load on the air conditioners in the hot season.
- Heat recovery minimises ventilation heat losses.
- Control of air exchange for creating comfortable indoor microclimate.
- Compatible with round Ø 125 mm air ducts.



**Air flow:**  
up to 250 m<sup>3</sup>/h  
69 l/s



**Heat recovery efficiency:**  
up to 78 %



### Design

- The casing of **KOMFORT Ultra L 250-H(E)** is made of double-skinned aluzinc panels, internally filled with 20 mm mineral wool layer for heat and sound insulation.
- The casing of **KOMFORT Ultra L 250-H(E) white** is made of double-skinned white painted metal panels, internally filled with 20 mm mineral wool layer for heat and sound insulation.
- The spigots are located at the side of the unit and are rubber sealed for airtight connection to the air ducts.
- The hinged panel of the casing ensures easy access to the unit internals for service works including cleaning, filter replacement, etc.

### Fans

- Asynchronous external rotor motors and centrifugal impellers with backward curved blades are used for air supply and exhaust.
- Integrated motor overheating protection with automatic restart.
- Dynamically balanced impellers.
- Equipped with ball bearings for longer service life.
- Reliable and quiet operation.

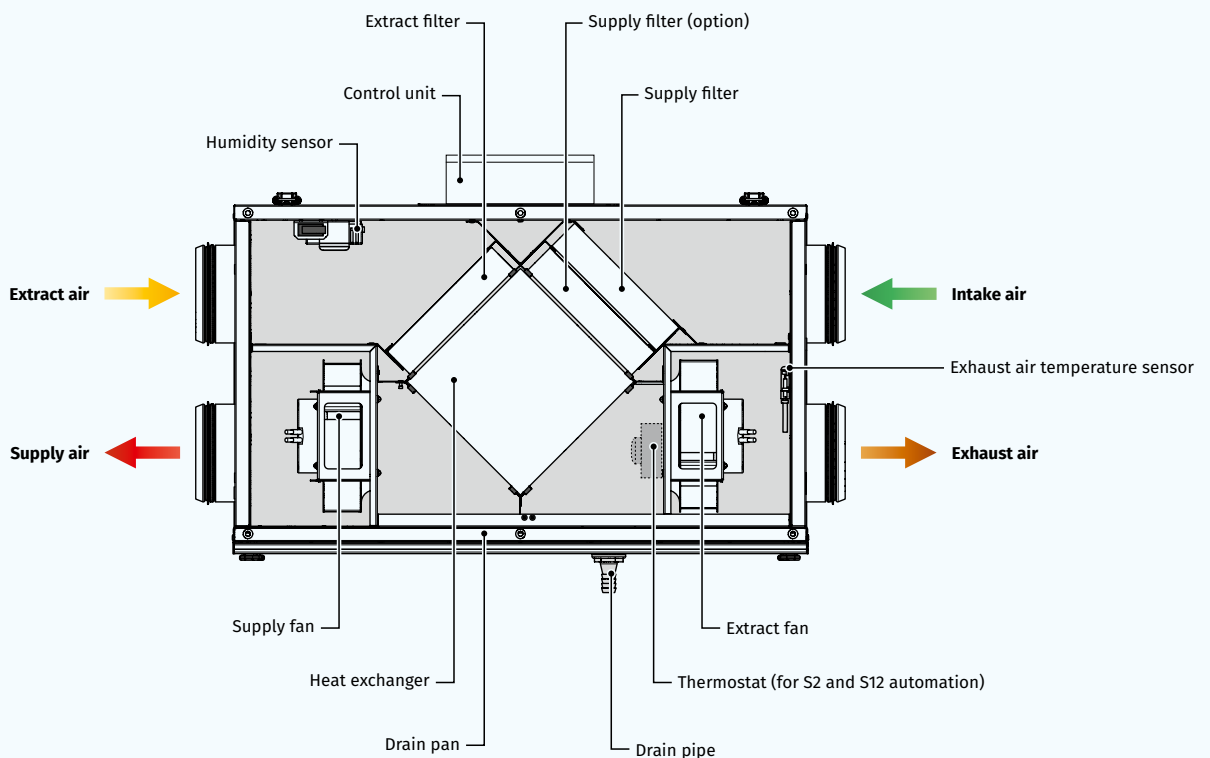

### Heat recovery

o The **KOMFORT Ultra L 250-H (white)** unit is equipped with a plate cross-flow polystyrene heat exchanger for heat recovery. The unit condensate is collected and drained to the drain pan under the heat exchanger.

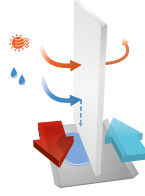

o The **KOMFORT Ultra L 250-E (white)** unit is equipped with an enthalpy plate cross-flow heat exchanger for energy (heat and humidity) recovery. Due to humidity recovery condensate is not generated in the enthalpy heat exchanger.



- o The air flows are completely separated in the heat exchanger. Thus smells and contaminants are not transferred from the extract air to the supply air.
- o Heat recovery is based on heat and/or humidity transfer through the heat exchanger plates. In the cold season supply air is heated in the heat exchanger by transferring the heat energy of warm and humid extract air to the cold fresh air. Heat recovery minimizes ventilation heat losses and heating costs respectively.
- o In the warm season the heat exchanger performs reverse and intake air is cooled in the heat exchanger by the cool extract air. That reduces operation load on air conditioners and saves electricity.
- o When the indoor and outdoor temperature difference is insignificant, heat recovery is not reasonable. In this case the heat exchanger can be temporary replaced with a summer block for the warm season (available as a specially ordered accessory).

### Air filtration

- o The built-in G4 supply filter and G4 extract filter provide air filtration.
- o The F8 supply filter (specially ordered accessory) may be used for efficient supply air filtration.

### Control and automation

- o Smooth motor speed control from 0 up to 100 % by means of the thyristor speed controller SGS E1 (included in the delivery).

### Mounting

- o The units can be fixed to the wall or mounted on the floor using the mounting brackets. The **KOMFORT Ultra L 250-E (white)** unit is also suitable for ceiling mounting.
- o The **KOMFORT Ultra L 250-H (white)** unit mounting position must provide condensate collection and drainage.
- o While mounting provide free access to the service panel for filter replacement and servicing.
- o Due to universal casing design both left and right mounting is possible. It requires swapping the service and the back panel.

### FREEZE PROTECTION

- o The integrated automatic freeze protection is used to prevent freezing of the heat exchanger in the cold season. The supply fan turns off according to the temperature sensor to get the heat exchanger warmed up with extract air. After that the supply fan turns on and the unit continues to run in the standard mode.

### Designation key

Series	Unit type	Spigot modification	Rated air flow [m³/h]	Heat exchanger type	Control	Casing
KOMFORT	<b>Ultra:</b> compact unit	L: horizontal spigot orientation	250	- H: heat recovery E: energy recovery	S1: speed controller CDT	- : aluzinc <b>white:</b> white-painted steel

### Overall dimensions [mm]

Model	D	B	H	H1	L	L1
KOMFORT Ultra L 250-H(E) (white)	125	300	443	43	713	810

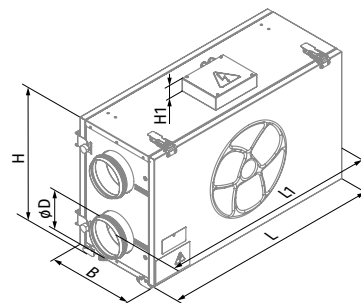

**Technical data**

Parameters	KOMFORT Ultra L 250-H	KOMFORT Ultra L 250-E
Voltage [V / 50 (60) Hz]	1 ~ 230	1 ~ 230
Power [W]	148	148
Current [A]	0.78	0.78
Maximum air flow [m³/h (l/s)]	250 (69)	250 (69)
Sound pressure level at 3 m [dBA]	28-47	28-47
Transported air temperature [°C]	-25...+40	-25...+40
Insulation	20 mm mineral wool	20 mm mineral wool
Extract filter	G4	G4
Supply filter	G4 (option: F8 PM2.5 > 81 %)	G4 (option: F8 PM2.5 > 81 %)
Connected air duct diameter [mm]	125	125
Heat recovery efficiency [%]	55-78	52-73
Humidity recovery efficiency [%]	-	27-45
Heat exchanger type	cross-flow	cross-flow
Heat exchanger material	polysterene	enthalpy
SEC class	E	E
ErP	2016	2016

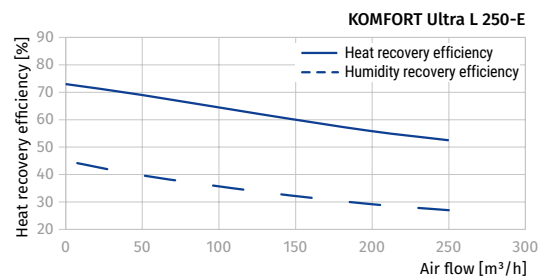
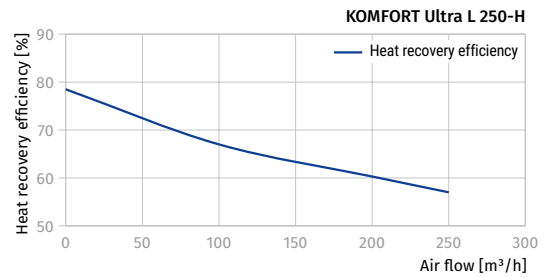
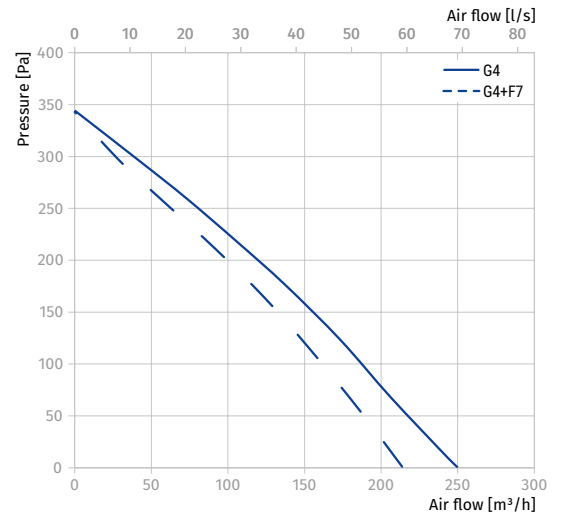

**Accessories**

		KOMFORT Ultra L 250-H	KOMFORT Ultra L 250-E
G4 panel filter		FP 240x184x40 G4	FP 240x184x40 G4
F8 panel filter		FP 240x184x40 F8	FP 240x184x40 F8
Silencer		SD 125	SD 125
Backdraft air damper		VRV 125	VRV 125
Air damper		VK 125	VK 125
Summer block		SB C4 200/240	SB C4 200/240

# KOMFORT ULTRA D 105

## Single room heat recovery air handling units

### Features

- Air handling units for efficient supply and exhaust ventilation in flats, houses, cottages and other buildings.
- Heat recovery minimises ventilation heat losses.
- Controllable air exchange for creating the best suitable indoor microclimate.
- Compatible with round Ø 125 mm air ducts.



**Air flow:**  
up to 106 m<sup>3</sup>/h  
29 l/s



**Heat recovery efficiency:**  
up to 76 %



### Design

- The compact casing is made of double-skinned aluzinc panels, internally filled with 15 mm PE foam film layer for heat and sound insulation.
- The casing has mounting angles for easy installation.
- The spigots for connection to the air ducts are located at the side of the unit and are rubber sealed for airtight connection to the air ducts.
- The supply and exhaust spigots are equipped with backdraft dampers.
- The hinged side panel of the casing ensures easy access to the internals for cleaning and other maintenance operations.

### Fans

- Asynchronous motors are used for air supply and exhaust.
- Centrifugal impeller with forward curved blades ensures high pressure and low noise level.
- Integrated overheating protection.
- Dynamically balanced impellers.
- Equipped with ball bearings for longer service life.

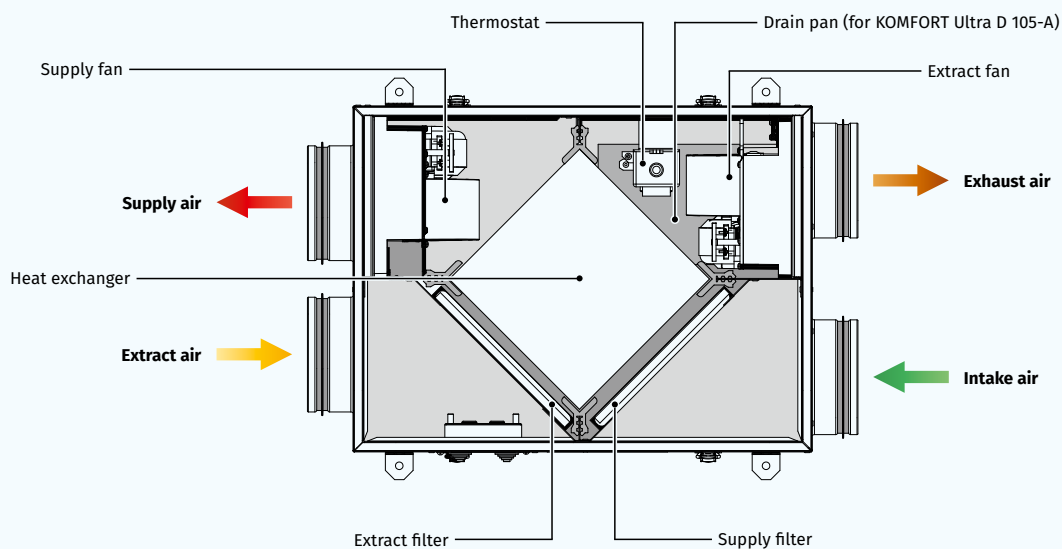

### Heat recovery

- The **KOMFORT Ultra D 105-A** unit is equipped with a plate cross-flow polystyrene heat exchanger for heat recovery. The unit condensate is collected and drained to the drain pan under the heat exchanger.
- The **KOMFORT Ultra D 105** unit is equipped with an enthalpy plate cross-flow heat exchanger for energy (heat and humidity) recovery. Due to humidity recovery condensate is not generated in the enthalpy heat exchanger.
- The air flows are completely separated in the heat exchanger. Thus smells and contaminants are not transferred from the extract air to the supply air.
- Heat recovery is based on heat and/or humidity transfer through the heat exchanger plates. In the cold season supply air is heated in the heat exchanger by transferring the heat energy of warm and humid extract air to the cold fresh air. Heat recovery minimizes ventilation heat losses and heating costs respectively.
- In the warm season the heat exchanger performs reverse and intake air is cooled in the heat exchanger by the cool extract air. That reduces operation load on air conditioners and saves electricity.
- When the indoor and outdoor temperature difference is insignificant, heat recovery is not reasonable. In this case the heat exchanger can be temporarily replaced with a summer block for the warm season (available as a specially ordered accessory).

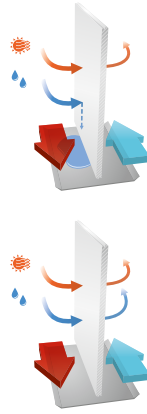

### Air filtration

- The built-in G4 supply filter and G4 extract filter provide air filtration.

### Control and automation

- The unit has three speeds. Air flow control by the external speed switch CDP-3/5.



### Mounting

- Indoor installation in horizontal position.
- Mounting in a false ceiling is possible due to compact casing size.
- A small air distribution network for central ventilation may be arranged based on the unit.
- The correctly mounted unit must provide free access to the hinged side panel for servicing and filter replacement.

### FREEZE PROTECTION

- The integrated electronic freeze protection system in **KOMFORT Ultra D 105-A** is used to prevent the heat exchanger freezing in cold seasons. In case of heat exchanger freezing danger communicated by the temperature sensor the supply fan is stopped to let warm extract air warm up the heat exchanger. After that the the supply fan is turned on and the unit reverts to the normal operation mode.

### Designation key

Series	Unit type	Mounting type	Rated air flow [m³/h]	Heat exchanger material
KOMFORT	Ultra: compact unit	D: suspended mounting, horizontally directed spigots	105	_: enthalpy -A: polystyrene

### Overall dimensions [mm]

Model	D	B	B1	B2	H	L	L1	L2
KOMFORT Ultra D 105	125	374	404	-	125	497	397	595
KOMFORT Ultra D 105-A	125	374	404	112.6	224	497	397	595

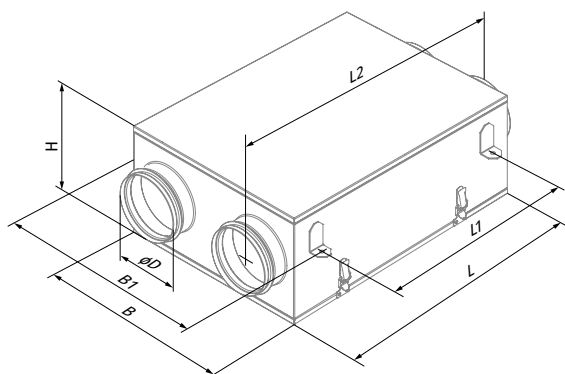

KOMFORT Ultra D 105

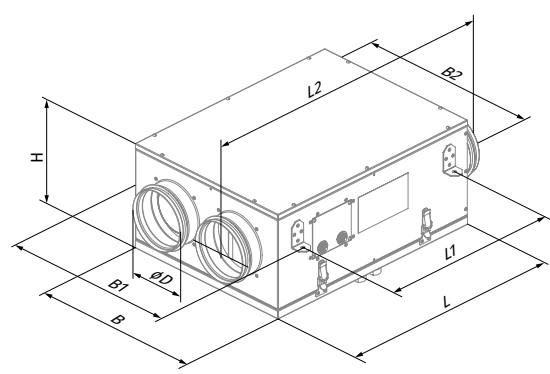

KOMFORT Ultra D 105-A



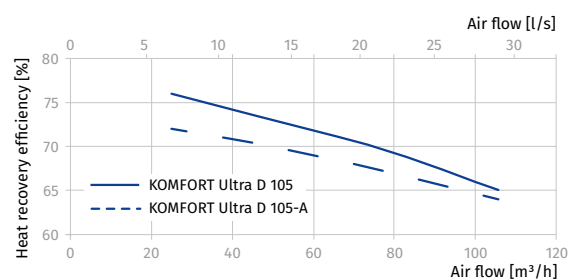
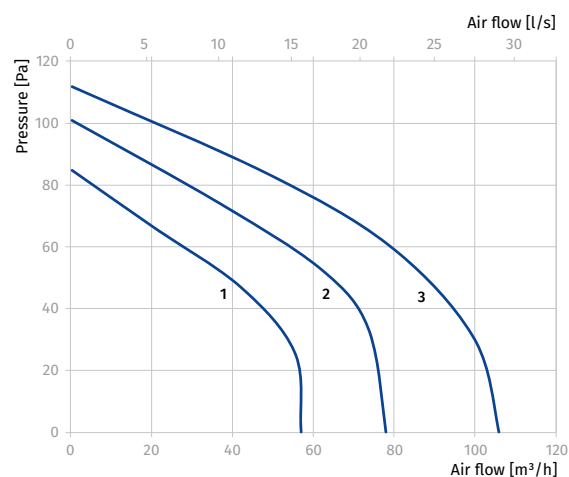

## Technical data

Parameters	KOMFORT Ultra D 105			KOMFORT Ultra D 105-A		
	I	II	III	I	II	III
Speed						
Voltage [V / 50 Hz]		1 ~ 230			1 ~ 230	
Power [W]	30	38	56	30	38	56
Current [A]	0.18	0.23	0.34	0.18	0.23	0.34
Maximum air flow [m <sup>3</sup> /h (l/s)]	57 (16)	78 (22)	106 (29)	57 (16)	78 (22)	106 (29)
Sound pressure level at 3 m [dBA]	24	32	41	24	32	41
Transported air temperature [°C]		-25...+40			-25...+40	
Casing material		aluzinc			aluzinc	
Insulation		15 mm polyethylene foam			15 mm polyethylene foam	
Extract / supply filter		G4			G4	
Connected air duct diameter [mm]		125			125	
Weight [kg]		10			13	
Heat recovery efficiency [%]		65-76			64-72	
Humidity recovery efficiency [%]		up to 45			-	
Heat exchanger type		cross-flow			cross-flow	
Heat exchanger material		enthalpy			polystyrene	
SEC class		D			D	
ErP		2016, 2018			2016, 2018	





**Accessories**

		KOMFORT Ultra D 105	KOMFORT Ultra D 105-A
G4 panel filter		FP 240x202x8 G4	FP 205x198x8 G4
Silencer		SD 125	SD 125
Backdraft air damper		VRV 125	VRV 125
Air damper		VK 125	VK 125
Summer block		SB C4 200/190	SB C4 200/190

# RENEO-FIT D 100 S14

## Heat and energy recovery air handling units

### Features

- Air handling units for efficient supply and exhaust ventilation in flats and apartments.
- Heat recovery minimizes ventilation heat losses during cold season and reduce air conditioner load during hot season.
- Controllable air exchange for creating the best suitable indoor microclimate.



**Air flow:**  
up to 130 m<sup>3</sup>/h  
36 l/s



**Heat recovery efficiency:**  
up to 94 %



### Design

- The casing is made of expanded polypropylene (EPP) with high heat- and sound-insulating properties.

### Fans

- High-efficient external rotor EC motors and centrifugal impellers with forward curved blades are used for air supply and exhaust.

### Air filtration

- Two built-in G4 and F7 filters provide efficient supply air filtration.
- The G4 filter is used for extract air filtration.

### Heat recovery

- The **Reneo-Fit D 100** unit is equipped with a counter-flow polysterene heat exchanger for heat recovery. The unit condensate is collected and drained to the drain pan under the heat exchanger.



- The **Reneo-Fit D 100-E** unit is equipped with an enthalpy counter-flow heat exchanger for heat and humidity recovery.



### Mounting

- The units are designed for suspended ceiling mounting.
- Service access for maintenance and filter replacement must be provided.

### Control and automation

- **Reneo-Fit D 100 S14** units are equipped with an integrated automation system and an S14 wall-mounted control panel with LED-indication.

### Automation functions

Functions	Description
Unit control via a remote wired control panel	S14 control panel 
Speed switch	+
Filter replacement indication	by filter timer
Alarm indication	LED indication about alarms
Freeze protection	using cyclical stops of the supply fan
Humidity control	option
CO <sub>2</sub> control	option
Fire alarm sensor connection	option

Option: the functionality is available when purchasing the appropriate accessory (see the "Accessories" section)

### Designation key

Series	Casing modification	Casing type	Heater	Nominal size	Modification	Heat exchanger type	Service side	Controller type
Reneo	- Fit: compact	D: suspended	_ : w/o heater	10: Nominal airflow	0: by default	- _ : heat recovery E: energy recovery	_ : universal	S14

### Overall dimensions [mm]

Model	H	L	L1	W	W1
Reneo-Fit D 100(-E) S14	242	530	630	520	600

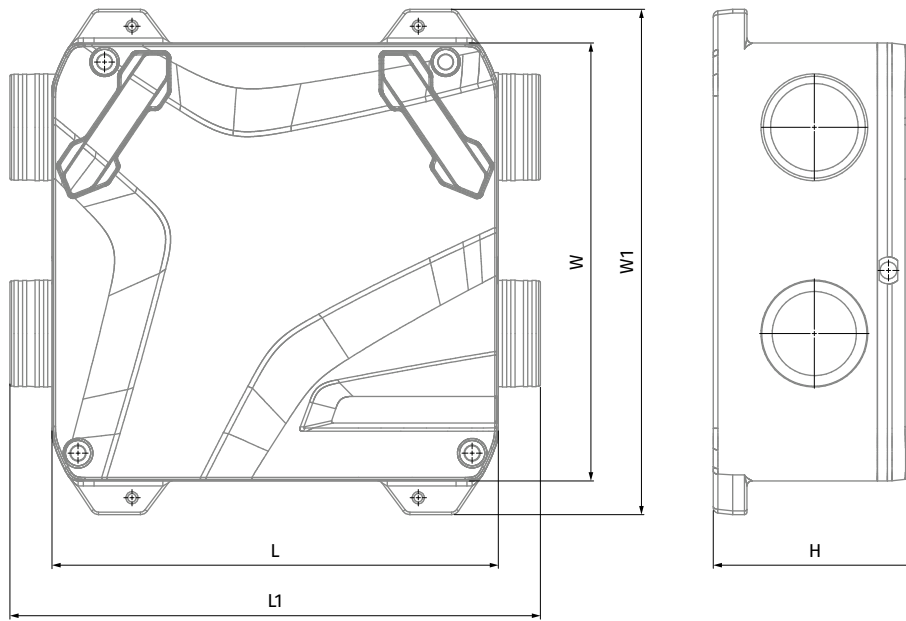

## Technical data

Parameters	Reneo-Fit D 100	Reneo-Fit D 100-E
Voltage [V / 50 (60) Hz]	1 ~ 230	1 ~ 230
Power [W]	38	38
Current [A]	0.34	0.34
Maximum air flow [m <sup>3</sup> /h (l/s)]	130 (36)	130 (36)
Sound pressure level at 3 m [dBA]	32	32
Transported air temperature [°C]	-23...+40	-23...+40
Casing material	EPP	EPP
Insulation [mm]	25	25
Extract filter	G4 / Coarse >60 %	G4 / Coarse >60 %
Supply filter	G4 / Coarse >60 % (option: F7 / ePM1 60 %)	G4 / Coarse >60 % (option: F7 / ePM1 60 %)
Connected air duct diameter [mm]	100 / 125	100 / 125
Weight [kg]	8	8
Heat recovery efficiency [%]	82-94	73-88
Heat exchanger type	counter-flow	counter-flow
Heat exchanger material	polystyrene	enthalpy
SEC class	A+	A







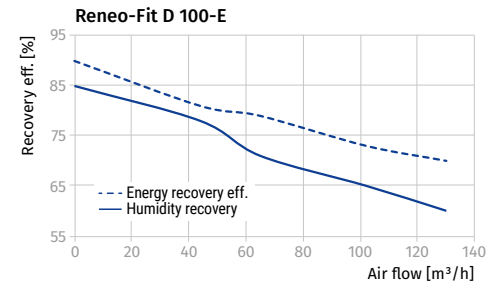
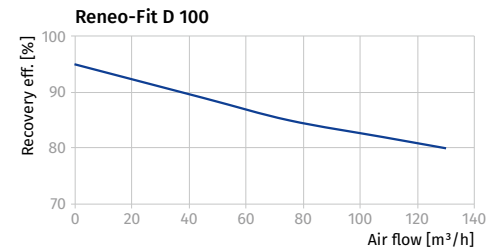
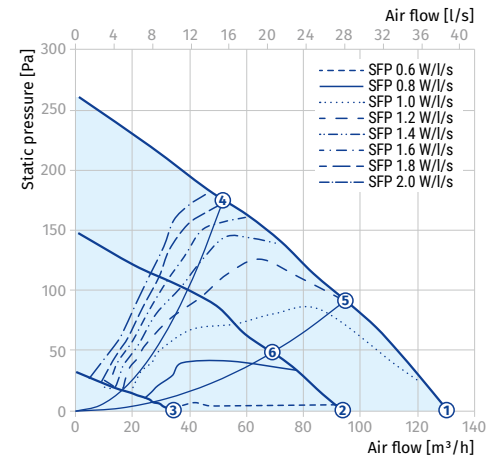



Sound power level, A-weighted	Total	Octave frequency band [Hz]							LpA 3 m	LpA 1 m
		200	400	800	1000	2000	4000	8000		
L <sub>WA</sub> to supply outlet [dBA]	59	44	45	49	51	44	37	38	38	48
L <sub>WA</sub> to exhaust inlet [dBA]	47	41	36	33	31	29	22	24	27	36
L <sub>WA</sub> to environment [dBA]	53	37	41	43	42	38	34	29	33	42

Sound data provided for point 2 on the diagram.

Point	Air flow [m <sup>3</sup> /h (l/s)]	Total sound pressure level (breakout) at 3 m (1 m) distance [dB(A)]
1	130 (36) @ 0 Pa	32 (42)
2	91 (25) @ 0 Pa	25 (35)
3	52 (14) @ 0 Pa	16 (26)
4	52 (14) @ 171 Pa	31 (41)
5	96 (27) @ 92 Pa	33 (42)
6	68 (19) @ 50 Pa	25 (34)



## Accessories

		Reneo-Fit D 100 S14	Reneo-Fit D 100-E S14
G4 panel filter		FP 176x150x22 G4	FP 176x150x22 G4
F7 panel filter		FP 176x150x22 F7	FP 176x150x22 F7
Control panel		S14	S14
Humidity sensor		FS2	FS2
Humidity sensor		HR-S	HR-S
CO <sub>2</sub> sensor		CD-2	CD-2
CO <sub>2</sub> sensor with indication		CD-1	CD-1
Syphon kit (for the units without an enthalpy heat exchanger)		SFK 20x32	SFK 20x32
Air damper		VKA 125	VKA 125
Electric actuator		TF230	TF230

# RENEO D

## Heat and energy recovery air handling units

### Features

- Air handling units for efficient supply and exhaust ventilation in flats, houses, cottages and other buildings.
- Heat recovery minimizes ventilation heat losses during the cold season and reduces air conditioner load during the hot season.
- Controllable air exchange for creating the best suitable indoor microclimate.
- Compatible with round 160 mm air ducts.



**Air flow:**  
up to 313 m<sup>3</sup>/h  
87 l/s



**Heat recovery efficiency:**  
up to 91 %



### Design

- The casing is made of expanded polypropylene (EPP) with high heat- and sound-insulating properties.
- The **Reneo D 181 / 241** units have flat service hatch design, suitable for decorative panel installation (delivered separately).

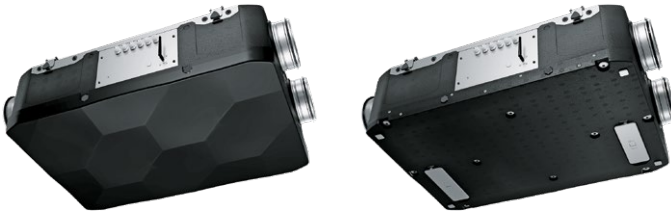

### Fans

- High-efficient external rotor **EC** motors and centrifugal impellers with forward-curved blades are used for air supply and exhaust.

### Air filtration

- Two built-in **Coarse 90% (G4)** filters provide efficient supply air filtration.
- Supply **ePM1 65% (F7)** filter available as an option.

EPP HEAT AND ENERGY RECOVERY AIR HANDLING UNITS

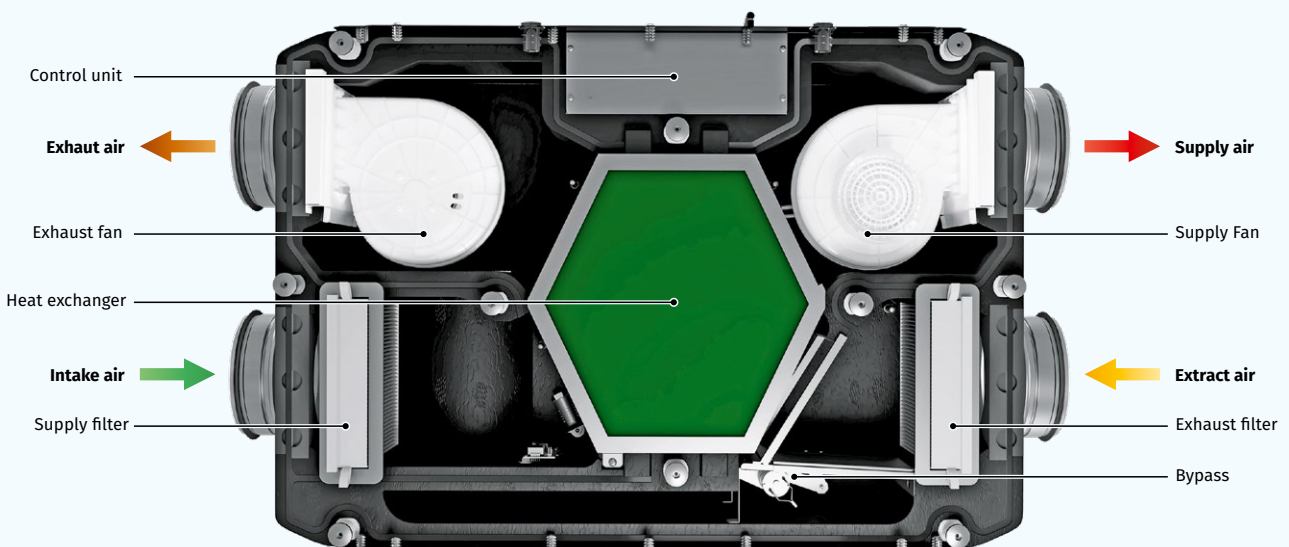

### Heat recovery

- The **Reneo D** unit is equipped with a counter-flow polyesterene heat exchanger for heat recovery. The condensate is collected and drained to the drain pan under the heat exchanger.
- The **Reneo D...-E** unit is equipped with an enthalpy counter-flow heat exchanger for heat and humidity recovery.

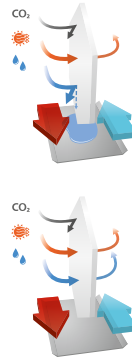

### Control and automation

- Reneo D S21** units are equipped with an integrated automation system. The remote control panel is not included in the delivery set.
- The S21 controller allows integrating the unit into the **Smart Home** system or **BMS (Building Management System)**.
- Unit control via Wi-Fi using the mobile application **Blauberg Home**.



Download the **Blauberg Home** app for Android



Download the **Blauberg Home** app for iOS







### Bypass

- The **Reneo D** units are equipped with a bypass, which can be opened if there is a need to cool down the ventilated area with cool intake air.

### Mounting

- The units are designed for suspended ceiling mounting, floor mounting, vertical or horizontal wall mounting.

### Automation functions

Functions	Reneo D S21	Reneo D S14
Unit control via Wi-Fi using a mobile application	+	-
Unit control via a wired remote control panel	S22 control panel (option) 	S14 control panel 
Unit control via a wireless remote control panel	S22 Wi-Fi control panel (option) 	-
Unit control via a remote wired LCD control panel	S25 control panel (option) 	-
BMS (Building Management System)	RS-485	-
	Wi-Fi	-
	Ethernet	-
	MODBUS (RTU, TCP)	-
Blauberg Cloud Server service	+	-
Speed selection	+	+
Filter replacement indication	by filter timer	by filter timer
	by filter clogging differential pressure switch	-
Alarm indication	full alarm description in the mobile application	LED alarm indication
Week-scheduled operation	+	-
Bypass	automatic	-
	manual	manual
Timer	+	-
Boost mode	+	-
Fireplace mode	+	-
Freeze protection	through cyclic stops of the supply fan	through cyclic stops of the supply fan
	through preheating (option)	-
Reheater connection	option	-
Cooler connection	option	-
Minimum supply air temperature control	+	-
Humidity control	option	option
CO <sub>2</sub> control	option	option
VOC control	option	-
PM2.5 control	option	-
Fire alarm sensor connection	option	option

Option: the function is available when purchasing the appropriate accessory (see the "Accessories" section).

**Designation key**

Series	Casing type	Nominal size	Modification	Heat exchanger type	Controller type
Reneo	D: suspended	18: Nominal airflow	0: standard 1: flat design with an option for attaching a decorative panel	- : heat recovery E: energy recovery	S21 S14

**Overall dimensions [mm]**

Model	∅ D	H	L	L1	W	W1
Reneo D	160	272	930	627	640	300

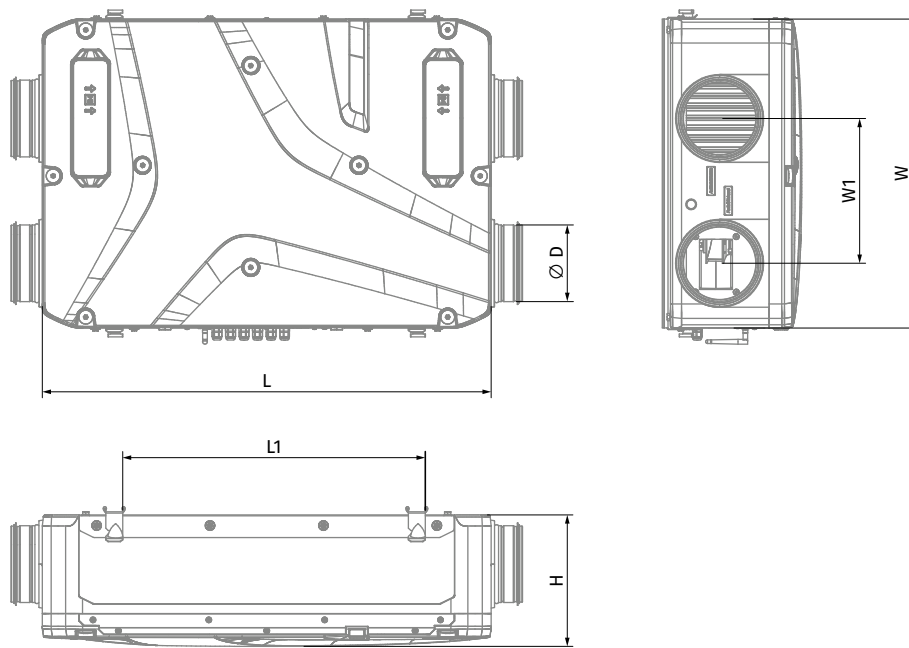



### Technical data

Parameters	Reneo D 180	Reneo D 180-E	Reneo D 240	Reneo D 240-E
Voltage [V / 50-60 Hz]	230	230	230	230
Max. unit power [W]	53	53	171	171
Max. unit current [A]	0.49	0.49	1.34	1.34
Max air flow [m³/h]	181	181	310	310
Sound pressure level at 3 m distance [dBA]	29	29	33	33
Max. operating temperature [°C]	45	45	45	45
Case material	EPP	EPP	EPP	EPP
Insulation	25 mm	25 mm	25 mm	25 mm
Extract filter	Coarse >60 %	Coarse >60 %	Coarse >60 %	Coarse >60 %
Supply filters	Coarse >60 % (G4) (option: ePM1 60 % (F7))	Coarse >60 % (G4) (option: ePM1 60 % (F7))	Coarse >60 % (G4) (option: ePM1 60 % (F7))	Coarse >60 % (G4) (option: ePM1 60 % (F7))
Connected air duct diameter [mm]	160	160	160	160
Weight [kg]	12	15	12	15
Heat recovery efficiency [%]	91	84	91	81
Heat exchanger type	counter-flow	counter-flow	counter-flow	counter-flow
Heat exchanger material	polystyrene	enthalpy membrane	polystyrene	enthalpy membrane
SEC class	A+	A	A	A

#### RENEO D 180







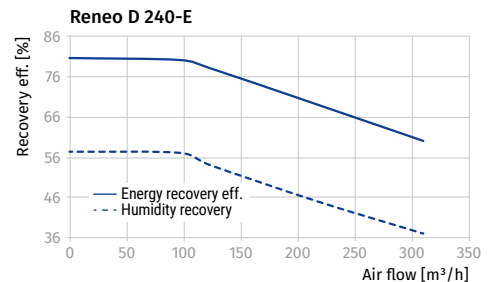
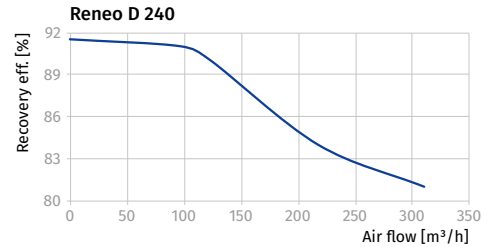
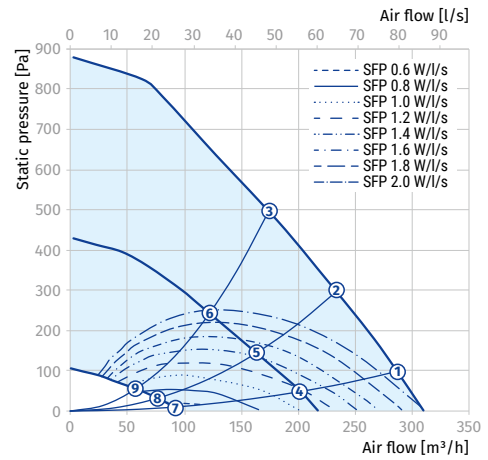
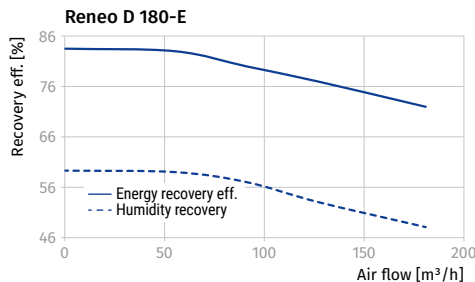
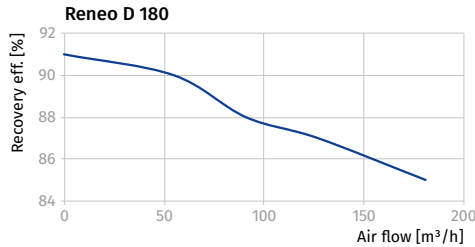
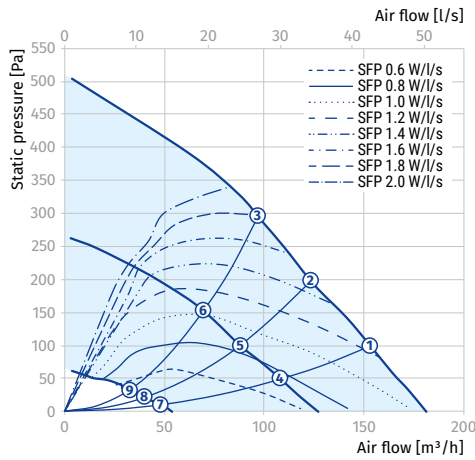









Sound power level, A-weighted	Total	Octave frequency band [Hz]								LpA 3 m	LpA 1 m
		63	125	250	500	1000	2000	4000	8000		
<b>Point 1</b>											
LWA to environment [dBA]	<b>58</b>	36	44	43	50	50	45	43	35	<b>37</b>	<b>47</b>
<b>Point 4</b>											
LWA to environment [dBA]	<b>49</b>	26	34	33	39	41	38	32	26	<b>29</b>	<b>38</b>

#### RENEO D 240

Sound power level, A-weighted	Total	Octave frequency band [Hz]								LpA 3 m	LpA 1 m
		63	125	250	500	1000	2000	4000	8000		
<b>Point 1</b>											
LWA to environment [dBA]	<b>61</b>	39	47	46	50	50	48	45	43	<b>40</b>	<b>50</b>
<b>Point 4</b>											
LWA to environment [dBA]	<b>53</b>	31	39	38	44	46	39	36	32	<b>33</b>	<b>42</b>



**Accessories**

		Reneo D 180(-E) S21	Reneo D 181(-E) S21	Reneo D 180(-E) S14	Reneo D 181(-E) S14
G4 panel filter		FP 205x200x48 Coarse 90% G4	FP 205x200x48 Coarse 90% G4	FP 205x200x48 Coarse 90% G4	FP 205x200x48 Coarse 90% G4
F7 panel filter		FP 205x200x48 ePM1 60% F7	FP 205x200x48 ePM1 60% F7	FP 205x200x48 ePM1 60% F7	FP 205x200x48 ePM1 60% F7
Decorative panel		-	EP-Reneo D 181	-	EP-Reneo D 181
LCD control panel		S25	S25	-	-
Control panel		S22	S22	-	-
Wireless control panel		S22 Wi-Fi	S22 Wi-Fi	-	-
Internal humidity sensor		FS2	FS2	FS2	FS2
Internal CO <sub>2</sub> sensor		CD-3	CD-3	CD-3	CD-3
CO <sub>2</sub> sensor with indication		CD-1	CD-1	CD-1	CD-1
CO <sub>2</sub> sensor		CD-2	CD-2	CD-2	CD-2
Humidity sensor		HR-S	HR-S	HR-S	HR-S
Electric preheater		EVH 160 S21 V.2	EVH 160 S21 V.2	-	-
Electric reheater		ENH 160 S21 V.2	ENH 160 S21 V.2	-	-
Syphon kit (for the units without an enthalpy heat exchanger)		SFK 20x32	SFK 20x32	SFK 20x32	SFK 20x32
Silencer		SD 160	SD 160	SD 160	SD 160
Air damper		VKA 160	VKA 160	VKA 160	VKA 160
Electric actuator		TF230	TF230	TF230	TF230

		Reneo D 240(-E) S21	Reneo D 241(-E) S21	Reneo D 240(-E) S14	Reneo D 241(-E) S14
G4 panel filter		FP 205x200x48 Coarse 90% G4	FP 205x200x48 Coarse 90% G4	FP 205x200x48 Coarse 90% G4	FP 205x200x48 Coarse 90% G4
F7 panel filter		FP 205x200x48 ePM1 60% F7	FP 205x200x48 ePM1 60% F7	FP 205x200x48 ePM1 60% F7	FP 205x200x48 ePM1 60% F7
Decorative panel		-	EP-Reneo D 181	-	EP-Reneo D 181
LCD control panel		S25	S25	-	-
Control panel		S22	S22	-	-
Wireless control panel		S22 Wi-Fi	S22 Wi-Fi	-	-
Internal humidity sensor		FS2	FS2	FS2	FS2
Internal CO <sub>2</sub> sensor		CD-3	CD-3	CD-3	CD-3
CO <sub>2</sub> sensor with indication		CD-1	CD-1	CD-1	CD-1
CO <sub>2</sub> sensor		CD-2	CD-2	CD-2	CD-2
Humidity sensor		HR-S	HR-S	HR-S	HR-S
Electric preheater		EVH 160 S21 V.2	EVH 160 S21 V.2	-	-
Electric reheater		ENH 160 S21 V.2	ENH 160 S21 V.2	-	-
Syphon kit (for the units without an enthalpy heat exchanger)		SFK 20x32	SFK 20x32	SFK 20x32	SFK 20x32
Silencer		SD 160	SD 160	SD 160	SD 160
Air damper		VKA 160	VKA 160	VKA 160	VKA 160
Electric actuator		TF230	TF230	TF230	TF230

# KOMFORT EC SB

## Heat and humidity recovery air handling units

### Features

- Air handling units for efficient energy saving supply and exhaust ventilation in flats, houses, cottages and other premises.
- Heat and humidity recovery minimizes ventilation heat losses during cold season and reduces air conditioner load during hot season.
- Controllable air exchange for creating the best suitable indoor microclimate.
- Compatible with round Ø 125, 160 or 200 mm air ducts.



**Air flow:**  
up to 692 m<sup>3</sup>/h  
192 l/s



**Heat recovery efficiency:**  
up to 98 %



### Design

- The casing is made of double-skinned polymer-coated steel panels, internally filled with 20, 30, 40 mm (depending on the unit model) mineral wool layer for heat- and sound-insulation.
- The unit is equipped with a hinged service panel to enable convenient access for maintenance or repair operations.
- The spigots are located at the top of the unit and are equipped with rubber seals for airtight connection to the air ducts.

### Fans

- The units are equipped with high-efficient EC motors with an external rotor and a centrifugal impeller with backward curved blades.
- EC motors have the best power consumption to air capacity ratio and meet the latest demands concerning energy saving and high-efficient ventilation.
- EC motors are featured with high performance, low noise level and optimum control across the entire speed range.
- The impellers are dynamically balanced.

### Air filtration

- The built-in F7 filter provides efficient supply air filtration. The G4 filter is used for extract air cleaning.
- In the **KOMFORT EC SB(E) 250** units, the supply air is cleaned by the G4 filter (F7 filter optionally available).

### Bypass

- The **KOMFORT EC SB(-E)** units are equipped with a bypass for ventilation (air cooling by the cool air from outside).

HEAT RECOVERY AIR HANDLING UNITS

**KOMFORT EC SB**

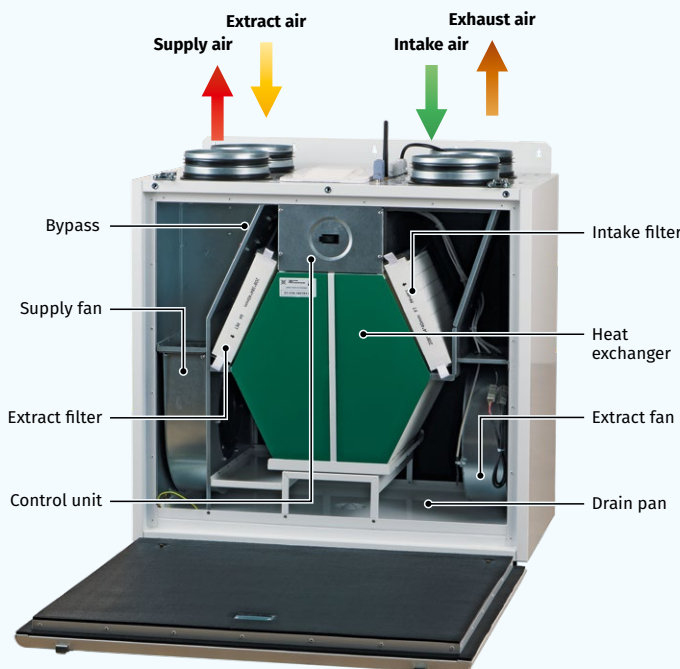

**KOMFORT EC SB(E) 250(-E)**

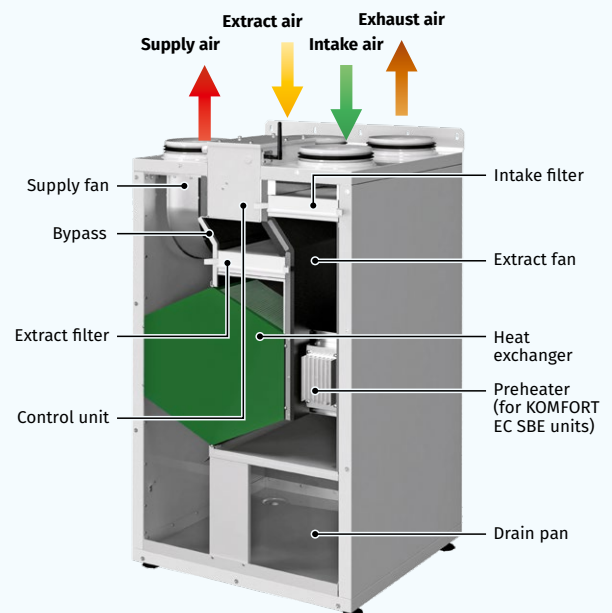

### Heat recovery

The **KOMFORT EC S(B)** unit is equipped with a plate counter-flow polystyrene heat exchanger for heat recovery. The unit condensate is collected and drained to the drain pan under the heat exchanger.



The **KOMFORT EC S(B)-E** unit is equipped with an enthalpy plate counter-flow heat exchanger for energy (heat and humidity) recovery. Due to humidity recovery condensate is not generated in the enthalpy heat exchanger.



- The air flows are completely separated in the heat exchanger. Thus smells and contaminants are not transferred from the extract air to the supply air.
- Heat recovery is based on heat and/or humidity transfer through the heat exchanger plates. In the cold season supply air is heated in the heat exchanger by transferring the heat energy of warm and humid extract air to the cold fresh air. Heat recovery minimizes ventilation heat losses and heating costs respectively.
- In the warm season the heat exchanger performs reverse and intake air is cooled in the heat exchanger by the cool extract air. That reduces operation load on air conditioners and saves electricity.
- When the indoor and outdoor temperature difference is insignificant, heat recovery is not reasonable. In this case the heat exchanger can be temporary replaced with a summer block for the warm season (available as a specially ordered accessory).

### Mounting

- The units are designed for wall or floor mounting.
- Universal casing design provides either left-handed or right-handed unit installation.

### Control and automation

- The **KOMFORT EC S(B)-E S21** units are equipped with an integrated automation system. The remote control panel is not included in the delivery set (available separately).
- The S21 controller allows to integrate the unit into the **Smart Home** system or **BMS (Building Management System)**.
- The unit can be controlled by the **Blauberg AHU** mobile application via Wi-Fi.



Download the **Blauberg AHU** app for Android







Download the **Blauberg AHU** app for iOS



- The **KOMFORT EC S(B)-E S14** units have an integrated automation system with a wall-mounted control panel S14 with a LED indication.

### Automation functions

Functions	KOMFORT EC S(B)-E S21	KOMFORT EC S(B)-E S14
Unit control via Wi-Fi using a mobile application	+	-
Unit control via a wired remote control panel	S22 control panel (option) 	S14 control panel 
Unit control via a wireless remote control panel	S22 Wi-Fi control panel (option) 	-
Unit control via a wired remote LCD control panel	S25 control panel (option) 	-
BMS (Building Management System)	RS-485	-
	Wi-Fi	-
	Ethernet	-
	MODBUS (RTU, TCP)	-
Blauberg Cloud Server service	+	-
Speed selection	+	+
Filter replacement indication	by filter timer by filter clogging differential pressure switch (KOMFORT EC SB 550)	by filter timer -
Alarm indication	full alarm description in the mobile application	LED alarm indication
Week-scheduled operation	+	-
Bypass	automatic	-
	manual	manual
Timer	+	-
Boost mode	+	-
Fireplace mode	+	-
Freeze protection	through cyclic stops of the supply fan	through cyclic stops of the supply fan
	through preheating (option)	-
Reheater connection	option	-
Cooler connection	option	-
Minimum supply air temperature control	+	-
Humidity control	option	option
CO <sub>2</sub> control	option	option
VOC control	option	-
PM2.5 control	option	-
Fire alarm sensor connection	option	option

Option: function is available when purchasing the appropriate accessory (see the "Accessories" section).

### Designation key

Series	Motor type	Spigot modification	Bypass	Heater type	Rated air flow, [m³/h]	Heat exchanger type	Service side	Control
KOMFORT	EC: electronically commutated motor	S: vertical spigot orientation	-: no bypass B: with a bypass	-: no heater E: integrated electric preheater	160; 250; 350; 550	-: heat recovery -E: energy recovery	L: left R: right (for KOMFORT EC SB(E) 250 only)	S21 S14

### Overall dimensions [mm]

Model	∅ D	B	H	L
KOMFORT EC S 160(-E) S14	125	330	550	600
KOMFORT EC SB 160(-E) S21/S14	125	330	580	600
KOMFORT EC SB(E) 250(-E) S21/S14	160	560	970	560
KOMFORT EC SB 350(-E) S21/S14	160	583	675	730
KOMFORT EC SB 550(-E) S21/S14	200	720	675	823

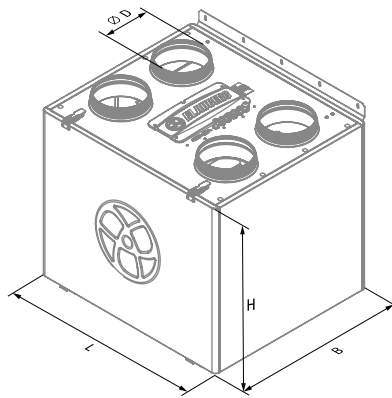

### Technical data

Parameters	KOMFORT EC SB 160 S21 KOMFORT EC SB 160 S14	KOMFORT EC SB 160-E S21 KOMFORT EC SB 160-E S14
Supply voltage [V / 50 (60) Hz]	1~ 230	1~ 230
Power [W]	57	57
Current [A]	0.5	0.5
Maximum air flow [m³/h (l/s)]	200 (56)	200 (56)
Sound pressure level at a distance of 3 m [dBA]	24	24
Transported air temperature [°C]	-25...+40	-25...+40
Casing material	polymer-coated steel	polymer-coated steel
Insulation	20 mm mineral wool	20 mm mineral wool
Extract filter	G4	G4
Supply filter	F7 (option: G4)	F7 (option: G4)
Connected air duct diameter [mm]	125	125
Weight [kg]	36	36
Heat recovery efficiency [%]	85–93	76–92
Heat exchanger type	counter-flow	counter-flow
Heat exchanger material	polystyrene	enthalpy
SEC class	A+	A
ErP	2016, 2018	2016, 2018

### KOMFORT EC S(B) 160(-E)

Sound power level, A-weighted	Total	Octave frequency band [Hz]								LpA 3 m	LpA 1 m
		63	125	250	500	1000	2000	4000	8000		
L <sub>WA</sub> to supply inlet [dBA]	52	28	46	49	41	35	33	36	29		
L <sub>WA</sub> to supply outlet [dBA]	60	32	52	58	47	37	36	41	35		
L <sub>WA</sub> to exhaust inlet [dBA]	51	27	45	49	41	36	32	35	29		
L <sub>WA</sub> to exhaust outlet [dBA]	60	31	50	59	48	36	36	41	32		
L <sub>WA</sub> to environment [dBA]	45	25	41	42	34	31	28	27	22	24	34

Data provided for point 1 of the air flow diagram

Point	Total power of the unit [W]	Sound pressure level at 3 m (1 m) [dBA]
1	57	24 (34)
2	56	23 (33)
3	54	23 (33)
4	28	20 (30)
5	27	20 (30)
6	26	20 (30)
7	14	13 (23)
8	13	13 (23)
9	13	13 (23)

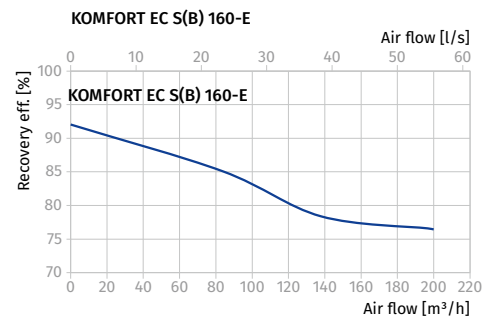
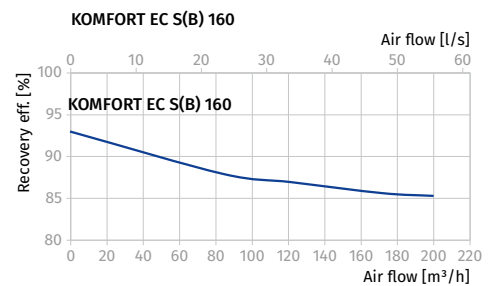
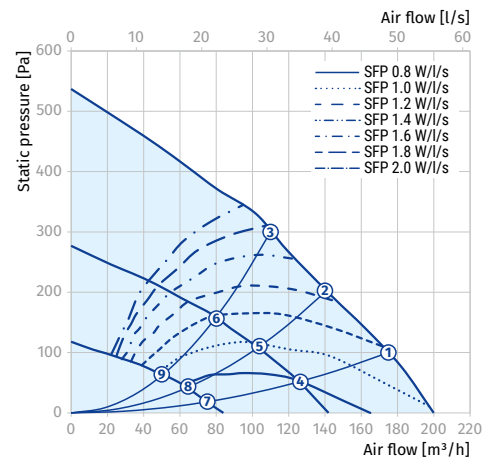

### Calculation of air temperature downstream of the heat exchanger:

$$t = t_{\text{outd}} + k_{\text{hr}} \times (t_{\text{extr}} - t_{\text{outd}}) / 100,$$

where

$t_{\text{outd}}$  – outdoor air temperature [°C]

$t_{\text{extr}}$  – extract air temperature [°C]

$k_{\text{hr}}$  – heat exchanger efficiency (according to the diagram) [%]

Parameters	KOMFORT EC SB 250 S21 KOMFORT EC SB 250 S14	KOMFORT EC SB 250-E S21 KOMFORT EC SB 250-E S14	KOMFORT EC SBE 250 S21	KOMFORT EC SBE 250-E S21
Supply voltage [V / 50 (60) Hz]	1~ 230	1~ 230	1~ 230	1~ 230
Power [W]	180	180	180	180
Current [A]	1.37	1.37	1.37	1.37
Electric heater power [W]	-	-	1400	1400
Electric heater current [A]	-	-	6.09	6.09
Max. unit power with electric heater [W]	180	180	1580	1580
Max. unit current with electric heater [A]	1.37	1.37	7.46	7.46
Maximum air flow [m³/h (l/s)]	390 (108)	390 (108)	390 (108)	390 (108)
Sound pressure level at a distance of 3 m [dBA]	35	35	35	35
Transported air temperature [°C]	-25...+40	-25...+40	-25...+40	-25...+40
Casing material	polymer-coated steel	polymer-coated steel	polymer-coated steel	polymer-coated steel
Insulation	30 mm mineral wool	30 mm mineral wool	30 mm mineral wool	30 mm mineral wool
Extract filter	G4	G4	G4	G4
Supply filter	G4 (option: F7)	G4 (option: F7)	G4 (option: F7)	G4 (option: F7)
Connected air duct diameter [mm]	160	160	160	160
Weight [kg]	66	66	66	66
Heat recovery efficiency [%]	88-95	78-90	88-95	78-90 %
Heat exchanger type	counter-flow	counter-flow	counter-flow	counter-flow
Heat exchanger material	polystyrene	enthalpy	polystyrene	enthalpy
SEC class	A+	A	A+	A
ErP	2016, 2018	2016, 2018	2016, 2018	2016, 2018

**KOMFORT EC SB(E) 250 (-E)**

Sound power level, A-weighted	Total	Octave frequency band [Hz]							LpA 3 m	LpA 1 m
		125	250	500	1000	2000	4000	8000		
L <sub>WA</sub> to supply inlet [dBA]	70	51	55	59	64	65	63	54	49	59
L <sub>WA</sub> to supply outlet [dBA]	68	50	55	59	64	63	58	53	48	58
L <sub>WA</sub> to exhaust inlet [dBA]	76	28	58	66	70	68	69	62	55	65
L <sub>WA</sub> to exhaust outlet [dBA]	67	27	56	65	57	59	54	47	47	57
L <sub>WA</sub> to environment [dBA]	56	24	50	49	47	45	48	45	35	45

Data provided for point 1 of the air flow diagram

Point	Total power of the unit [W]	Sound pressure level at 3 m (1 m) [dBA]
1	180	35 (45)
2	179	35 (45)
3	168	35 (45)
4	63	24 (34)
5	57	24 (34)
6	52	23 (33)
7	15	18 (27)
8	15	17 (27)
9	14	17 (27)

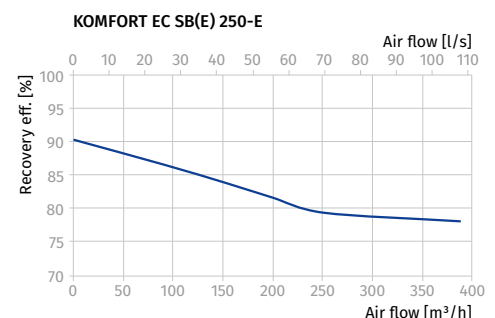
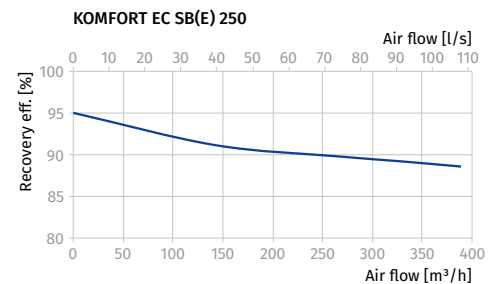
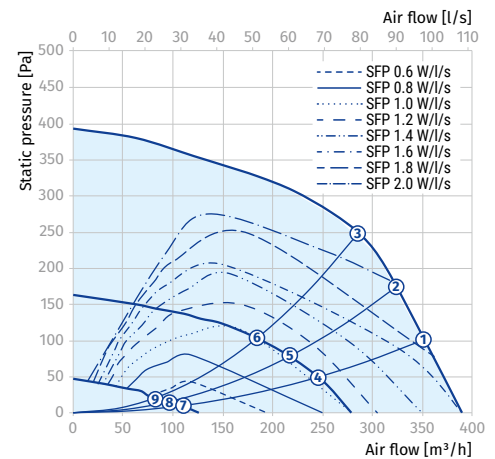



Parameters	KOMFORT EC SB 350 S21 KOMFORT EC SB 350 S14	KOMFORT EC SB 350-E S21 KOMFORT EC SB 350-E S14
Supply voltage [V / 50 (60) Hz]	1~ 230	1~ 230
Power [W]	178	178
Current [A]	1.4	1.4
Maximum air flow [m³/h (l/s)]	450 (125)	450 (125)
Sound pressure level at a distance of 3 m [dBA]	28	28
Transported air temperature [°C]	-25...+40	-25...+40
Casing material	polymer-coated steel	polymer-coated steel
Insulation	40 mm mineral wool	40 mm mineral wool
Extract filter	G4	G4
Supply filter	F7 (option: G4)	F7 (option: G4)
Connected air duct diameter [mm]	160	160
Weight [kg]	64	64
Heat recovery efficiency [%]	85-92	73-91
Heat exchanger type	counter-flow	counter-flow
Heat exchanger material	polystyrene	enthalpy
SEC class	A+	A
ErP	2016, 2018	2016, 2018

**KOMFORT EC SB 350(-E)**

Sound power level, A-weighted	Total	Octave frequency band [Hz]								LpA 3 m	LpA 1 m
		63	125	250	500	1000	2000	4000	8000		
L <sub>WA</sub> to supply inlet [dBA]	56	50	46	53	45	39	34	36	32		
L <sub>WA</sub> to supply outlet [dBA]	64	56	52	63	52	39	38	43	35		
L <sub>WA</sub> to exhaust inlet [dBA]	56	52	46	53	45	38	34	36	31		
L <sub>WA</sub> to exhaust outlet [dBA]	64	58	53	62	51	40	38	42	33		
L <sub>WA</sub> to environment [dBA]	49	45	40	44	38	33	29	27	22	28	38

Data provided for point 1 of the air flow diagram

Point	Total power of the unit [W]	Sound pressure level at 3 m (1 m) [dBA]
1	177	28 (38)
2	175	27 (37)
3	170	27 (37)
4	71	23 (33)
5	71	22 (32)
6	69	22 (32)
7	21	15 (25)
8	21	14 (24)
9	21	14 (24)

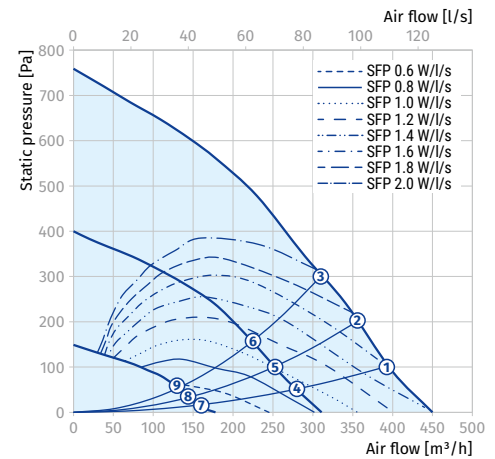

**KOMFORT EC S(B) 350**

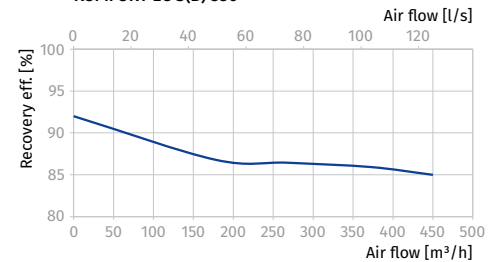

**KOMFORT EC S(B) 350-E**

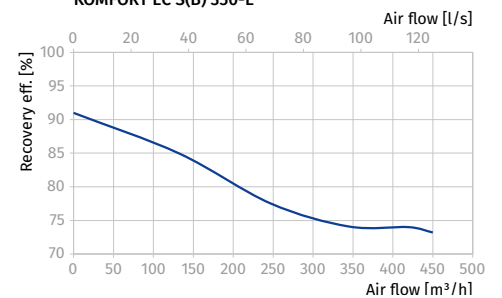

**KOMFORT EC SB 350**

Parameters	KOMFORT EC SB 550 S21 KOMFORT EC SB 550 S14	KOMFORT EC SB 550-E S21 KOMFORT EC SB 550-E S14
Supply voltage [V / 50 (60) Hz]	1~ 230	1~ 230
Power [W]	350	350
Current [A]	2.4	2.4
Maximum air flow [m³/h (l/s)]	692 (192)	692 (192)
Sound pressure level at a distance of 3 m [dBA]	38	38
Transported air temperature [°C]	-25...+40	-25...+40
Casing material	polymer-coated steel	polymer-coated steel
Insulation	40 mm mineral wool	40 mm mineral wool
Extract filter	G4	G4
Supply filter	F7 (option: G4)	F7 (option: G4)
Connected air duct diameter [mm]	200	200
Weight [kg]	82	82
Heat recovery efficiency [%]	85-92	73-91
Heat exchanger type	counter-flow	counter-flow
Heat exchanger material	polystyrene	enthalpy
SEC class	A+	A
ErP	2016, 2018	2016, 2018

**KOMFORT EC SB 550(-E)**

Sound power level, A-weighted	Total	Octave frequency band [Hz]								LpA 3 m	LpA 1 m
		63	125	250	500	1000	2000	4000	8000		
LWA to supply outlet [dBA]	68	53	49	53	63	61	53	78	43		
LWA to exhaust inlet [dBA]	62	44	42	47	49	46	42	36	27		
LWA to environment [dBA]	56	41	37	39	43	45	45	38	35	38	48

Data provided for point 1 of the air flow diagram

Point	Total power of the unit [W]	Sound pressure level at 3 m (1 m) [dBA]
1	345	38 (48)
2	349	36 (45)
3	349	36 (45)
4	131	27 (37)
5	131	27 (37)
6	131	27 (37)
7	22	17 (26)
8	22	17 (27)
9	22	17 (27)

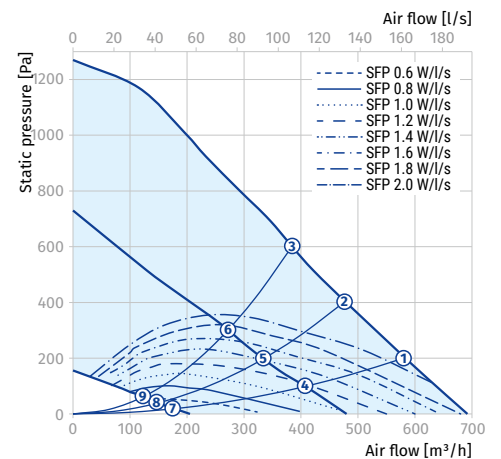



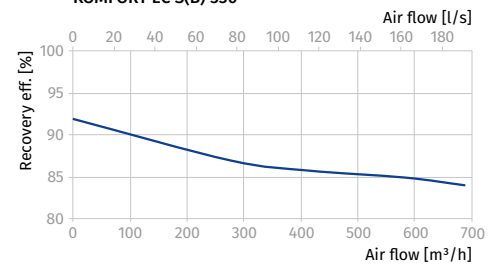



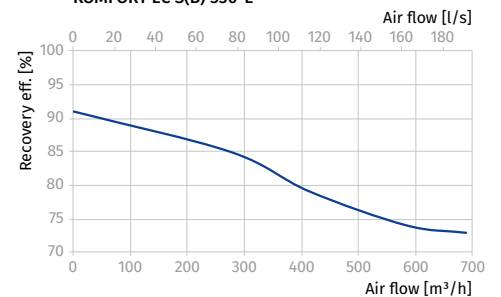







**KOMFORT EC S(B) 550**

















**KOMFORT EC S(B) 550-E**



## Accessories

		KOMFORT EC SB 160(-E) S21	KOMFORT EC SB 160(-E) S14
G4 panel filter		–	–
G4 panel filter		FP 285x195x10 G4	FP 285x195x10 G4
F7 panel filter		FP 285x195x10 F7	FP 285x195x10 F7
Control panel		S22	–
Wireless control panel		S22 Wi-Fi	–
LCD control panel		S25	–
Humidity sensor		FS2	FS2
CO <sub>2</sub> sensor with indication		CD-1	CD-1
CO <sub>2</sub> sensor		CD-2	CD-2
Humidity sensor		HR-S	HR-S
Electric preheater		EVH 125 S21 V.2	–
Electric reheater		ENH 125 S21 V.2	–
Syphon kit (for the units without an enthalpy heat exchanger)		SFK 20x32	SFK 20x32
Air damper		VKA 125	VKA 125
Electric actuator		TF230	TF230

		KOMFORT EC SB 250(-E) S21	KOMFORT EC SB 250(-E) S14	KOMFORT EC SBE 250(-E) S21
G4 panel filter		FP 500x170x48 G4	FP 500x170x48 G4	FP 500x170x48 G4
G4 panel filter		FP 340x170x48 G4	FP 340x170x48 G4	FP 340x170x48 G4
F7 panel filter		FP 340x170x48 F7	FP 340x170x48 F7	FP 340x170x48 F7
Control panel		S22	-	S22
Wireless control panel		S22 Wi-Fi	-	S22 Wi-Fi
LCD control panel		S25	-	S25
Humidity sensor		FS2	FS2	FS2
CO <sub>2</sub> sensor with indication		CD-1	CD-1	CD-1
CO <sub>2</sub> sensor		CD-2	CD-2	CD-2
Humidity sensor		HR-S	HR-S	HR-S
Electric preheater		-	-	-
Electric reheater		ENH-160 S21 V.2	-	ENH-160 S21 V.2
Syphon kit (for the units without an enthalpy heat exchanger)		SFK 20x32	SFK 20x32	-
Air damper		VKA 160	VKA 160	VKA 160
Electric actuator		TF230	TF230	TF230

		KOMFORT EC SB 350(-E) S21	KOMFORT EC SB 350(-E) S14	KOMFORT EC SB 550(-E) S21	KOMFORT EC SB 550(-E) S14
G4 panel filter		–	–	–	–
G4 panel filter		FP 500x196x40 G4	FP 500x196x40 G4	FP 630x198x40 G4	FP 630x198x40 G4
F7 panel filter		FP 500x196x40 F7	FP 500x196x40 F7	FP 630x198x40 F7	FP 630x198x40 F7
Control panel		S22	–	S22	–
Wireless control panel		S22 Wi-Fi	–	S22 Wi-Fi	–
LCD control panel		S25	–	S25	–
Humidity sensor		FS2	FS2	FS2	FS2
CO <sub>2</sub> sensor with indication		CD-1	CD-1	CD-1	CD-1
CO <sub>2</sub> sensor		CD-2	CD-2	CD-2	CD-2
Humidity sensor		HR-S	HR-S	HR-S	HR-S
Electric preheater		EVH 160 S21 V.2	–	EVH 200 S21 V.2	–
Electric reheater		ENH 160 S21 V.2	–	ENH 200 S21 V.2	–
Syphon kit (for the units without an enthalpy heat exchanger)		SFK 20x32	SFK 20x32	SFK 20x32	SFK 20x32
Air damper		VKA 160	VKA 160	VKA 200	VKA 200
Electric actuator		TF230	TF230	TF230	TF230

# KOMFORT EC DB

## Suspended heat recovery air handling units

### Features

- Air handling units for efficient supply and exhaust ventilation in flats, houses, cottages and other buildings.
- Heat recovery minimises ventilation heat losses.
- Controllable air exchange for creating the best suitable indoor microclimate.
- Compatible with round Ø 125 and 160 mm air ducts.



**Air flow:**  
up to 410 m<sup>3</sup>/h  
114 l/s



**Heat recovery efficiency:**  
up to 98 %



### Design

- The casing is made of double-skinned aluzinc panels, internally filled with 40 mm mineral wool layer for heat and sound insulation.
- The panel of the casing ensures easy access to the internals for cleaning and other maintenance operations.
- The spigots for connection to the air ducts are located at the sides of the unit and are rubber sealed for airtight connection to the air ducts.

### Fans

- High-efficient external rotor EC motors and centrifugal impellers with backward curved blades are used for air supply and exhaust.
- EC motors have the best power consumption to air flow ratio and meet the latest demands concerning energy saving and high-efficient ventilation.

- EC motors are featured with high performance, low noise level and totally controllable speed range.
- Dynamically balanced impellers.

### Bypass

- The units are equipped with the 100 % bypass for summer ventilation (room cooling by the cool intake air).

### Air filtration

- The built-in F7 filter provides efficient supply air filtration.
- The G4 filter is used for extract air filtration.

HEAT RECOVERY AIR HANDLING UNITS

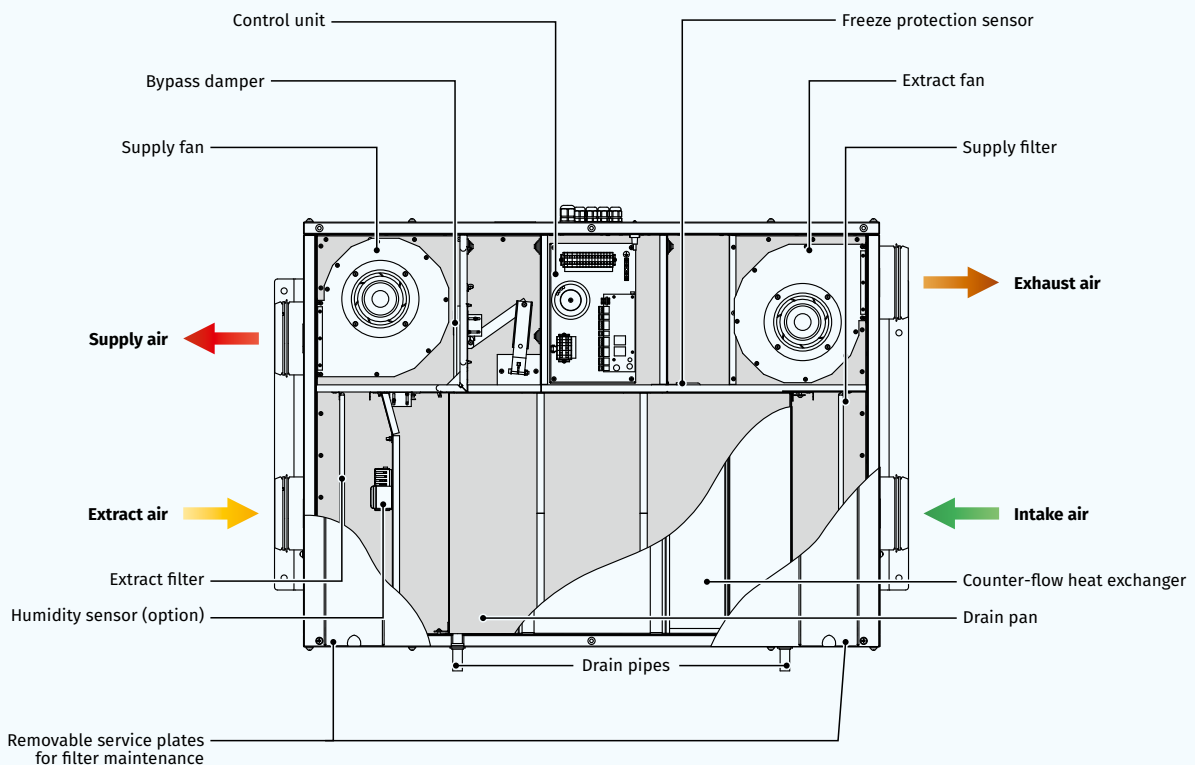

### Heat recovery

- The unit is equipped with a plate counter-flow aluminium heat exchanger for heat recovery. The unit condensate is collected and drained to the drain pan under the heat exchanger.
- The air flows are completely separated in the heat exchanger. Thus smells and contaminants are not transferred from the extract air to the supply air.
- Heat recovery is based on heat and/or humidity transfer through the heat exchanger plates. In the cold season supply air is heated in the heat exchanger by transferring the heat energy of warm and humid extract air to the cold fresh air. Heat recovery minimizes ventilation heat losses and heating costs respectively.
- In the warm season the heat exchanger performs reverse and intake air is cooled in the heat exchanger by the cool extract air. That reduces operation load on air conditioners and saves electricity.



### Control and automation

- The **KOMFORT EC DB S21** units are equipped with an integrated automation system. The remote control panel is not included in the delivery set (available separately).
- The S21 controller allows to integrate the unit into the **Smart Home** system or **BMS (Building Management System)**.
- The unit can be controlled by the **Blauberg AHU** mobile application via Wi-Fi.



Download the **Blauberg AHU** app for Android



Download the **Blauberg AHU** app for iOS

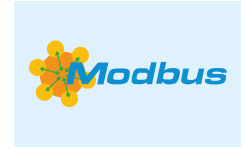





- The **KOMFORT EC DB S14** units have an integrated automation system with a wall-mounted control panel S14 with a LED indication.

### Mounting

- The units are designed for ceiling or wall mounting.
- The mounting place must provide enough space for connection to drain system and condensate drainage using the SFK 20x32 kit (available separately).

### Automation functions

Functions	KOMFORT EC DB S21	KOMFORT EC DB S14
Unit control via Wi-Fi using a mobile application	+	-
Unit control via a wired remote control panel	S22 control panel (option) 	S14 control panel 
Unit control via a wireless remote control panel	S22 Wi-Fi control panel (option) 	-
Unit control via a wired remote LCD control panel	S25 control panel (option) 	-
BMS (Building Management System)	RS-485	-
	Wi-Fi	-
	Ethernet	-
	MODBUS (RTU, TCP)	-
Blauberg Cloud Server service	+	-
Speed selection	+	+
Filter replacement indication	by filter timer	by filter timer
	by filter clogging differential pressure switch	-
Alarm indication	full alarm description in the mobile application	LED alarm indication
Week-scheduled operation	+	-
Bypass	automatic	-
	manual	manual
Timer	+	-
Boost mode	+	-
Fireplace mode	+	-
Freeze protection	through cyclic stops of the supply fan	through cyclic stops of the supply fan
	through preheating (option)	-
Reheater connection	option	-
Cooler connection	option	-
Minimum supply air temperature control	+	-
Humidity control	option	option
CO <sub>2</sub> control	option	option
VOC control	option	-
PM2.5 control	option	-
Fire alarm sensor connection	option	option

Option: function is available when purchasing the appropriate accessory (see the "Accessories" section).

### Designation key

Series	Motor type	Mounting type	Bypass	Rated air flow [m³/h]	Service side	Control
KOMFORT	EC: electronically commutated motor	D: suspended mounting, horizontally directed spigots	B: integrated bypass	160; 250; 350	R: right L: left	S21 S14

### Overall dimensions [mm]

Model	D	B	H	H1	L
KOMFORT EC DB 160 S21/S14	125	754	320	361	1008
KOMFORT EC DB 250 S21/S14	125	754	320	361	1008
KOMFORT EC DB 350 S21/S14	160	1044	320	363	1138

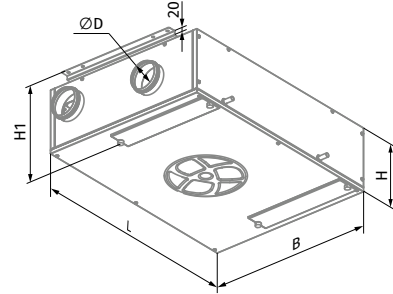

### Technical data

Parameters	KOMFORT EC DB 160 S21 KOMFORT EC DB 160 S14	KOMFORT EC DB 250 S21 KOMFORT EC DB 250 S14	KOMFORT EC DB 350 S21 KOMFORT EC DB 350 S14
Voltage [V / 50 (60) Hz]	1 ~ 230	1 ~ 230	1 ~ 230
Power [W]	50	101	170
Current [A]	0.4	0.8	1.3
Maximum air flow [m³/h (l/s)]	190 (53)	270 (75)	410 (114)
Sound pressure level at 3 m [dBA]	26	28	34
Transported air temperature [°C]	-25...+40	-25...+40	-25...+40
Casing material	galvanized steel	galvanized steel	galvanized steel
Insulation	40 mm mineral wool	40 mm mineral wool	40 mm mineral wool
Extract filter	G4	G4	G4
Supply filter	F7	F7	F7
Connected air duct diameter [mm]	125	125	160
Weight [kg]	48	48	70
Heat recovery efficiency [%]	82-94	80-98	80-91
Heat exchanger type	counter-flow	counter-flow	counter-flow
Heat exchanger material	polystyrene	polystyrene	polystyrene
SEC class	A+	A	A+
ErP	2016, 2018	2016, 2018	2016, 2018

### KOMFORT EC DB 160

Sound power level, A-weighted	Total	Octave frequency band [Hz]								LpA 3 m	LpA 1 m
		63	125	250	500	1000	2000	4000	8000		
L <sub>WA</sub> to supply inlet [dBA]	53	32	45	50	45	38	34	36	29		
L <sub>WA</sub> to supply outlet [dBA]	61	36	51	60	52	38	39	41	33		
L <sub>WA</sub> to exhaust inlet [dBA]	53	33	45	50	45	38	34	35	31		
L <sub>WA</sub> to exhaust outlet [dBA]	61	37	51	59	54	41	40	41	33		
L <sub>WA</sub> to environment [dBA]	47	29	41	44	37	34	28	27	23	26	36

Data provided for point 1 of the air flow diagram

Point	Total power of the unit [W]	Sound pressure level at 3 m (1 m) [dBA]
1	49	26 (36)
2	49	26 (36)
3	48	25 (35)
4	21	22 (32)
5	21	22 (32)
6	20	21 (31)
7	8	19 (29)
8	8	18 (28)
9	8	18 (28)

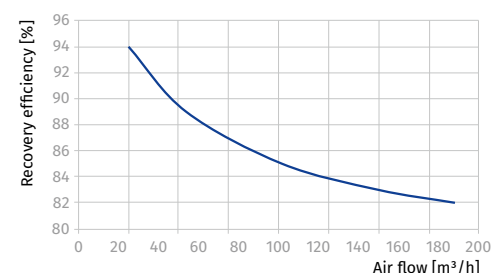
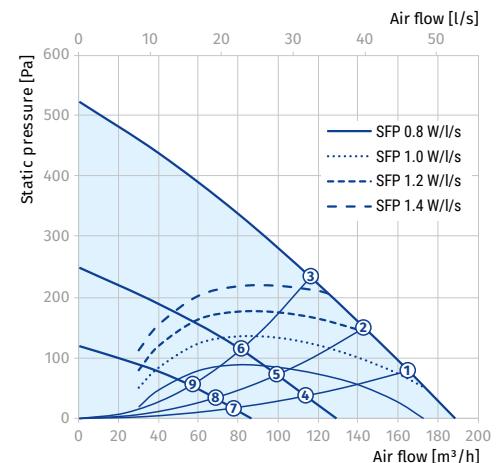



### KOMFORT EC DB 250

Sound power level, A-weighted	Total	Octave frequency band [Hz]								LpA 3 m	LpA 1 m
		63	125	250	500	1000	2000	4000	8000		
L <sub>WA</sub> to supply inlet [dBA]	55	51	45	51	44	37	33	35	30		
L <sub>WA</sub> to supply outlet [dBA]	65	59	54	63	52	41	39	43	34		
L <sub>WA</sub> to exhaust inlet [dBA]	55	50	45	51	44	37	33	35	31		
L <sub>WA</sub> to exhaust outlet [dBA]	66	57	53	64	53	39	38	43	35		
L <sub>WA</sub> to environment [dBA]	49	45	40	44	38	33	29	27	22	28	38

Data provided for point 1 of the air flow diagram

Point	Total power of the unit [W]	Sound pressure level at 3 m (1 m) [dBA]
1	100	28 (38)
2	99	27 (37)
3	98	27 (37)
4	55	23 (33)
5	54	22 (32)
6	54	22 (32)
7	17	15 (25)
8	17	14 (24)
9	16	14 (24)

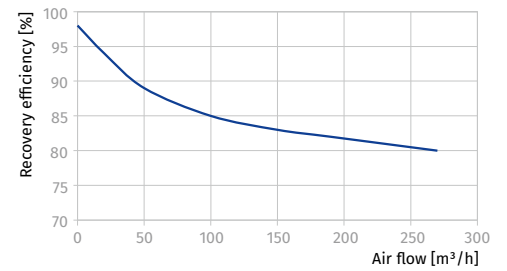
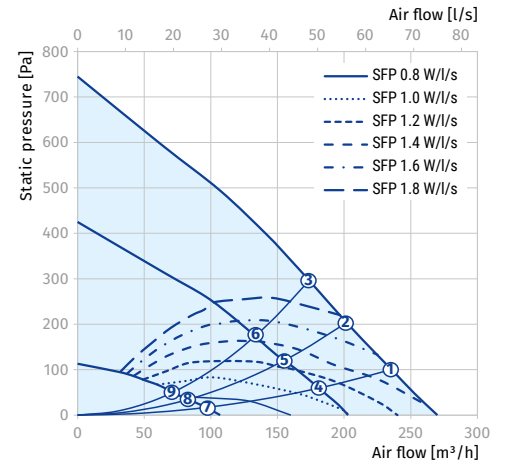

### KOMFORT EC DB 350







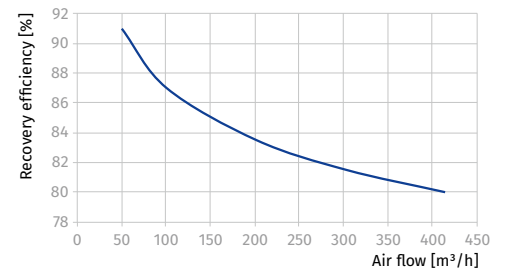
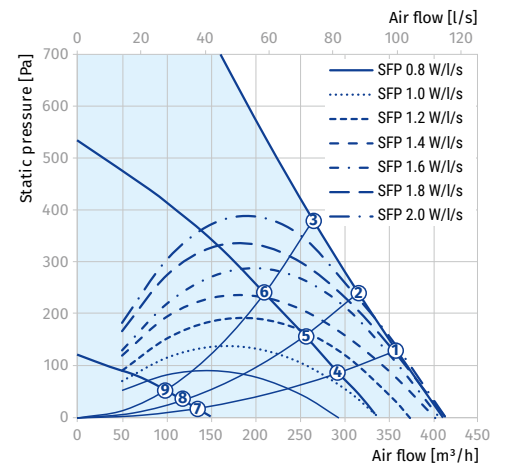







Sound power level, A-weighted	Total	Octave frequency band [Hz]								LpA 3 m	LpA 1 m
		63	125	250	500	1000	2000	4000	8000		
L <sub>WA</sub> to supply inlet [dBA]	60	46	54	58	50	46	40	40	31		
L <sub>WA</sub> to supply outlet [dBA]	63	52	58	60	54	46	40	41	35		
L <sub>WA</sub> to exhaust inlet [dBA]	61	47	54	58	50	47	41	41	32		
L <sub>WA</sub> to exhaust outlet [dBA]	63	51	58	59	56	46	40	41	35		
L <sub>WA</sub> to environment [dBA]	55	44	51	51	43	38	32	28	24	34	44















Data provided for point 1 of the air flow diagram

Point	Total power of the unit [W]	Sound pressure level at 3 m (1 m) [dBA]
1	169	34 (44)
2	169	34 (44)
3	169	33 (43)
4	87	28 (38)
5	86	28 (38)
6	84	27 (37)
7	20	22 (32)
8	19	22 (32)
9	19	21 (31)



**Accessories**

		KOMFORT EC DB 160 S21	KOMFORT EC DB 160 S14	KOMFORT EC DB 250 S21	KOMFORT EC DB 250 S14
G4 panel filter		FP 403x253x48 G4	FP 403x253x48 G4	FP 403x253x48 G4	FP 403x253x48 G4
F7 panel filter		FP 403x253x48 F7	FP 403x253x48 F7	FP 403x253x48 F7	FP 403x253x48 F7
Control panel		S22	-	S22	-
Wireless control panel		S22 Wi-Fi	-	S22 Wi-Fi	-
LCD control panel		S25	-	S25	-
Humidity sensor		FS2	FS2	FS2	FS2
Humidity sensor		HR-S	HR-S	HR-S	HR-S
CO <sub>2</sub> sensor with indication		CD-1	CD-1	CD-1	CD-1
CO <sub>2</sub> sensor		CD-2	CD-2	CD-2	CD-2
Electric preheater		EVH 125 S21 V.2	-	EVH 125 S21 V.2	-
Electric reheater		ENH 125 S21 V.2	-	ENH 125 S21 V.2	-
Syphon kit		SFK 20x32	SFK 20x32	SFK 20x32	SFK 20x32
Silencer		SD 125	SD 125	SD 125	SD 125
Air damper		VKA 125	VKA 125	VKA 125	VKA 125
Electric actuator		TF230	TF230	TF230	TF230

		KOMFORT EC DB 350 S21	KOMFORT EC DB 350 S14
G4 panel filter		FP 603x253x48 G4	FP 603x253x48 G4
F7 panel filter		FP 603x253x48 F7	FP 603x253x48 F7
Control panel		S22	-
Wireless control panel		S22 Wi-Fi	-
LCD control panel		S25	-
Humidity sensor		FS2	FS2
Humidity sensor		HR-S	HR-S
CO <sub>2</sub> sensor with indication		CD-1	CD-1
CO <sub>2</sub> sensor		CD-2	CD-2
Electric preheater		EVH 160 S21 V.2	-
Electric reheater		ENH 160 S21 V.2	-
Syphon kit		SFK 20x32	SFK 20x32
Silencer		SD 160	SD 160
Air damper		VKA 160	VKA 160
Electric actuator		TF230	TF230

# KOMFORT ERV EC DB

## Suspended heat and energy recovery air handling units

### Features

- Air handling units for efficient supply and exhaust ventilation in flats, houses, cottages and other buildings.
- Reduction of load on air conditioning systems in a hot climate and heat loss in a cold climate due to heat and moisture recovery.
- Control of air exchange for creating comfortable indoor microclimate.
- Compatible with round Ø 100 or 150 mm air ducts.



**Air flow:**  
up to 430 m<sup>3</sup>/h  
119 l/s



**Heat recovery efficiency:**  
up to 85 %



### Design

- The casing is made of polymer-coated steel panels, internally filled with foamed polyurethane layer 5–10 mm (depend on modification) for heat- and sound-insulation.
- The unit is equipped with a removable bottom panel for ease of maintenance. This service panel is used to access the filters and the heat exchanger for maintenance operations.
- The spigots are located at the sides of the unit and are equipped with rubber seals for airtight connection to the air ducts.
- The casing is equipped with fixing brackets to suspend the unit to the ceiling.

### Fans

- The unit is equipped with high-efficient external rotor EC motors used for air supply and exhaust.
- The **KOMFORT ERV EC DB 100 S14**, **KOMFORT ERV EC DB 150 S14** and **KOMFORT ERV EC DB 250 S14** units are equipped with a centrifugal impeller with forward curved blades and the **KOMFORT ERV EC DB 350 S14** units – with backward curved blades.
- EC motors have the best power consumption to air flow ratio and meet the latest demands concerning energy saving and high-efficient ventilation.
- EC motors are featured with high performance, low noise level and totally controllable speed range.
- The impellers are dynamically balanced.

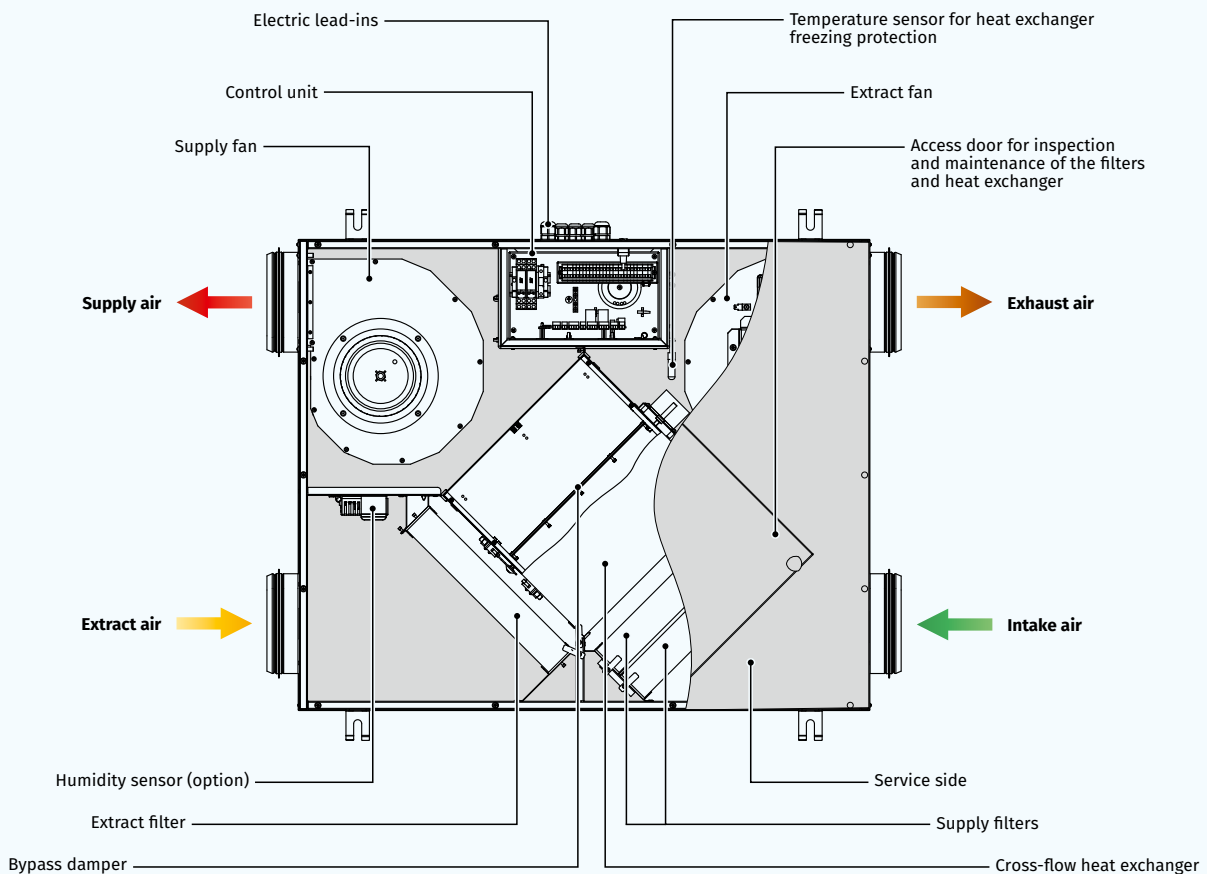

### Heat recovery

- The unit is equipped with an enthalpy plate cross-flow heat exchanger for energy (heat and humidity) recovery. Due to humidity recovery condensate is not generated in the enthalpy heat exchanger.



- The air flows are completely separated in the heat exchanger. Thus smells and contaminants are not transferred from the extract air to the supply air.
- Heat recovery is based on heat and/or humidity transfer through the heat exchanger plates. In the cold season supply air is heated in the heat exchanger by transferring the heat energy of warm and humid extract air to the cold fresh air. Heat recovery minimizes ventilation heat losses and heating costs respectively.
- In the warm season the heat exchanger performs reverse and intake air is cooled in the heat exchanger by the cool extract air. That reduces operation load on air conditioners and saves electricity.

### FREEZE PROTECTION

- The integrated automatic freeze protection is used to prevent freezing of the heat exchanger in the cold season. The supply fan turns off according to the temperature sensor to get the heat exchanger warmed up with extract air. After that the supply fan turns on and the unit continues to run in the standard mode.

### Air filtration

- Two built-in G4 and F8 filters provide efficient supply air filtration.
- The G4 filter is used for extract air filtration.

### Bypass

- The units are equipped with a bypass for summer ventilation (air cooling by the cool air from outside).

### Designation key

Series	Unit type	Motor type	Mounting type	Bypass	Rated air flow [m³/h]	Service side	Control
KOMFORT	ERV: energy recovery ventilation	EC: electronically commutated motor	D: suspended mounting, horizontally directed spigots	B: integrated bypass	100; 150; 250; 350	R: right L: left	S14: sensor control panel with LED indication

### Overall dimensions [mm]

Model	D	B	H	L	L1
KOMFORT ERV EC DB 100 S14	100	481	204	600	734
KOMFORT ERV EC DB 150 S14	100	704	222	854	987
KOMFORT ERV EC DB 250 S14	150	704	227	854	987
KOMFORT ERV EC DB 350 S14	150	754	277	1024	1157

### Control and automation

- The **KOMFORT ERV EC DB S14** units have an with a wall-mounted control panel S14 with a LED indication. The units are equipped with a USB connector (Type B) and can be connected to a PC for configuring the advanced settings in a special software.
- The standard delivery set includes a 10 m cable for connection of the unit to the control panel.
- S14 automation functions:**
  - Unit On/Off.
  - Unit performance control (selection of Low, Medium or High speed).
  - Bypass damper opening and closing for summer ventilation.
  - Alarm indication.
  - Filter maintenance indication.
- Additional functions of the S14 automation with installed software:**
  - Fan speed adjustment from 0 to 100 %. Each speed is individually adjusted for the supply and the extract fans.
  - Operation control on feedback from the FS2 duct humidity sensor (to be ordered separately).
  - Unit operation setting according to the external control unit (to be ordered separately).
  - Temperature setting for freeze protection system activation.
  - Control and operation adjustment of the filter maintenance timer
  - External relay control unit and humidity level control.
  - Software version upgrading.



### Mounting

- Due to a low casing height the air handling units are a perfect solution for space-restricted installation above suspended ceilings.
- The unit mounting position must provide access for service maintenance.

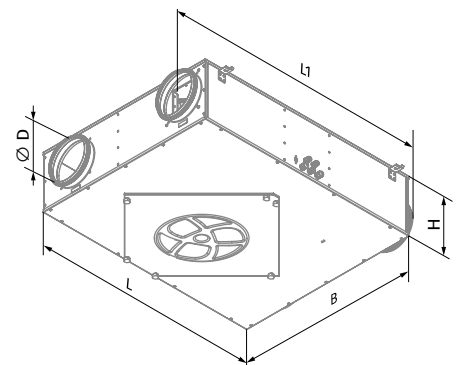

**Technical data**

Parameters	KOMFORT ERV EC DB 100 S14	KOMFORT ERV EC DB 150 S14	KOMFORT ERV EC DB 250 S14	KOMFORT ERV EC DB 350 S14
Voltage [V / 50 (60) Hz]	1~230	1 ~ 230	1 ~ 230	1 ~ 230
Power [W]	66	83	84	171
Current [A]	0.5	0.7	0.7	1.3
Maximum air flow [m <sup>3</sup> /h (l/s)]	170 (47)	215 (60)	300 (83)	430 (119)
Sound pressure level at 3 m [dBA]	30	32	36	46
Transported air temperature [°C]	-5...+40	-5...+40	-5...+40	-5...+40
Extract filter	G4	G4	G4	G4
Supply filter	G4 + F8 (PM2.5 > 93 %)	G4 + F8 (PM2.5 > 93 %)	G4 + F8 (PM2.5 > 83 %)	G4 + F8 (PM2.5 > 87 %)
Connected air duct diameter [mm]	100	100	150	150
Weight [kg]	17	26	29	42
Heat recovery efficiency [%]*	70–82	68–82	63–73	68–85
Humidity recovery efficiency [%]	24–41	22–41	16–27	19–34
Heat exchanger type	cross-flow	cross-flow	cross-flow	cross-flow
Heat exchanger material	enthalpy	enthalpy	enthalpy	enthalpy
SEC class	A	A	A	A
ErP	2016, 2018	2016, 2018	2016, 2018	2016, 2018

\*Heat recovery efficiency is specified in compliance with EN 13141-7.

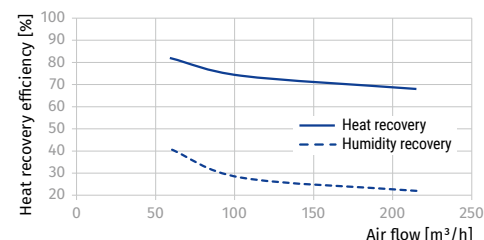
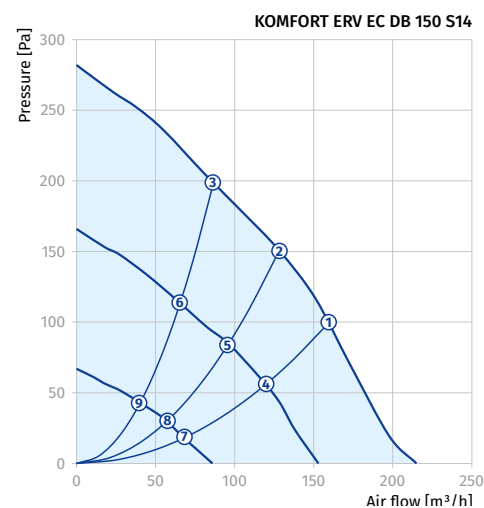
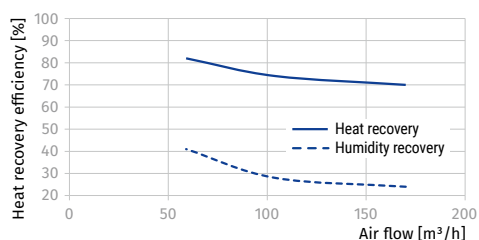
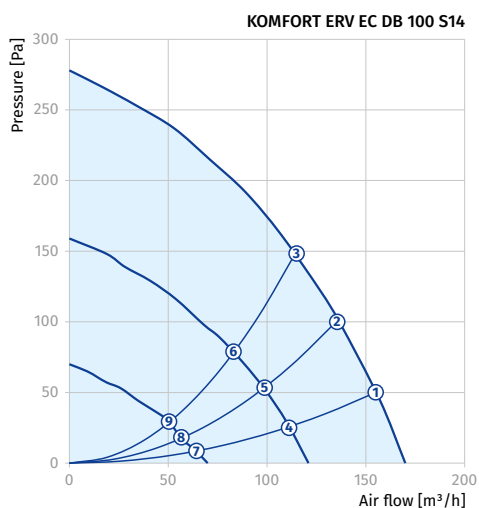
**Total power of the unit [W]**

Point	KOMFORT ERV EC DB 100 S14	KOMFORT ERV EC DB 150 S14	KOMFORT ERV EC DB 250 S14	KOMFORT ERV EC DB 350 S14
1	62	64	80	147
2	55	61	67	145
3	48	55	59	144
4	30	26	43	75
5	27	24	34	73
6	25	23	28	70
7	13	13	23	21
8	13	13	22	21
9	12	13	19	20

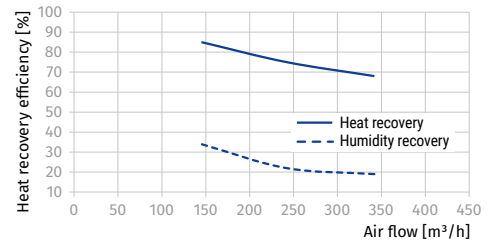
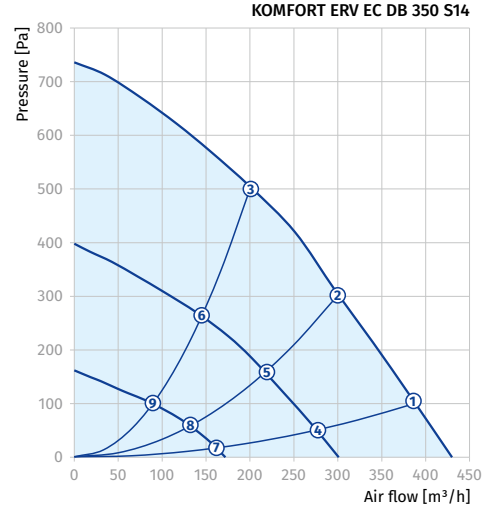
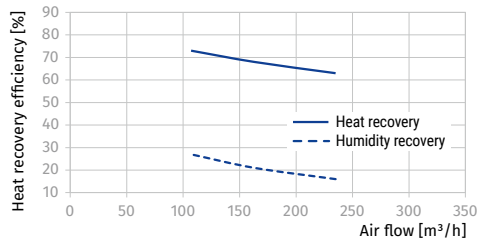
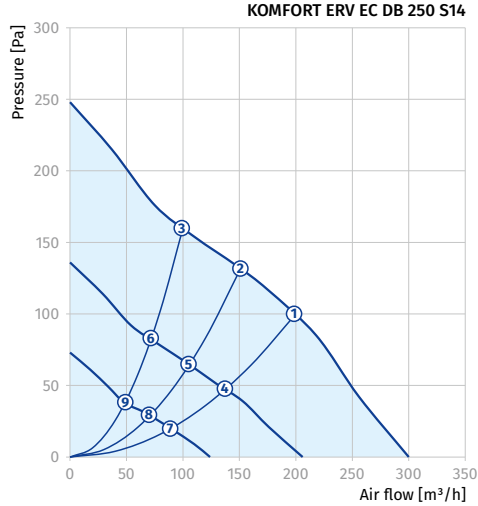

**Accessories**

		KOMFORT ERV EC DB 100 S14	KOMFORT ERV EC DB 150 S14	KOMFORT ERV EC DB 250 S14	KOMFORT ERV EC DB 350 S14
G4 panel filter		FP 200x191x20 G4	FP 300x220x48 G4	FP 300x220x48 G4	FP 300x270x48 G4
F8 panel filter		FP 200x191x40 F8	FP 300x220x48 F8	FP 300x220x48 F8	FP 300x270x48 F8
Humidity sensor		FS2	FS2	FS2	FS2
CO <sub>2</sub> sensor with indication		CD-1	CD-1	CD-1	CD-1
CO <sub>2</sub> sensor		CD-2	CD-2	CD-2	CD-2
Humidity sensor		HR-S	HR-S	HR-S	HR-S
Air damper		VKA 100	VKA 100	VKA 150	VKA 150
Electric actuator		TF230	TF230	TF230	TF230

HEAT RECOVERY AIR HANDLING UNITS

# KOMFORT ERV D S20

## Suspended heat and energy recovery air handling units

### Features

- Air handling unit for efficient supply and exhaust ventilation in flats, houses, cottages and other buildings.
- Heat and humidity recovery minimizes ventilation heat losses during cold season and reduce air conditioner load during hot season.
- Controllable air exchange ensures the best suitable indoor microclimate.
- Compatible with round Ø 100 or 150 mm air ducts.



**Air flow:**  
up to 400 m<sup>3</sup>/h  
111 l/s



**Heat recovery efficiency:**  
up to 87 %



### Design

- The casing is made of polymer coated steel panels, internally heat- and sound-insulated with 5–10 mm (depend on modification) polyurethane foam.
- The bottom service panel provides easy access for maintenance of the filters and the heat exchanger.
- The spigots for connection to the air ducts are located at the sides of the unit and are rubbed sealed for airtight connection to the air ducts.
- The mounting brackets on the casing ensure easy installation under the ceiling.

### Fans

- Asynchronous motors are used for air supply and exhaust.
- The units are equipped with a centrifugal impeller with forward curved blades.
- Integrated overheating protection with automatic restart.
- Ball bearings for longer service life.
- Dynamically balanced impellers.
- Featured with reliable and low-noise operation.

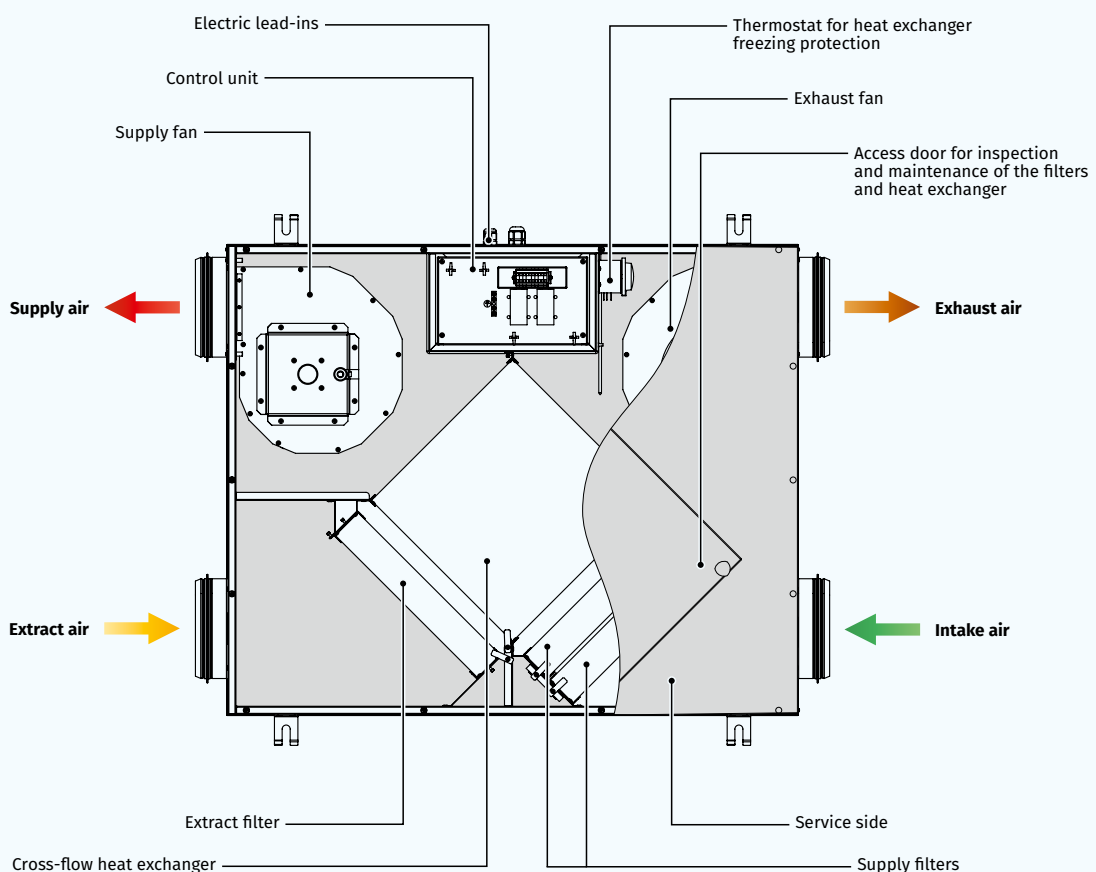



### Heat recovery

- The unit is equipped with an enthalpy plate cross-flow heat exchanger for energy (heat and humidity) recovery. Due to humidity recovery condensate is not generated in the enthalpy heat exchanger.



- The air flows are completely separated in the heat exchanger. Thus smells and contaminants are not transferred from the extract air to the supply air.
- Heat recovery is based on heat and/or humidity transfer through the heat exchanger plates. In the cold season supply air is heated in the heat exchanger by transferring the heat energy of warm and humid extract air to the cold fresh air. Heat recovery minimizes ventilation heat losses and heating costs respectively.
- In the warm season the heat exchanger performs reverse and intake air is cooled in the heat exchanger by the cool extract air. That reduces operation load on air conditioners and saves electricity.

### Control and automation

- Integrated control system based on triac speed controller CDT1 E.



### Air filtration

- Two built-in G4 and F8 filters provide efficient supply air filtration.
- The G4 filter is used for extract air filtration.

### Mounting

- Due to the low casing height the unit is the ideal solution for mounting in the limited space behind the suspended ceiling.
- The installation place must be easily accessible for servicing.

### FREEZE PROTECTION

- The integrated automatic freeze protection is used to prevent freezing of the heat exchanger in the cold season. The supply fan turns off according to the temperature sensor to get the heat exchanger warmed up with extract air. After that the supply fan turns on and the unit continues to run in the standard mode.

### Designation key

Series	Unit type	Mounting type	Rated air flow [m³/h]	Service side	Control
KOMFORT	ERV: energy recovery ventilation	D: suspended mounting, horizontally directed spigots	150; 250; 350	R: right L: left	S20: speed controller CDT1 E

### Overall dimensions [mm]

Model	∅ D	B	H	L	L1
KOMFORT ERV D 150 S20	99	704	227	854	947
KOMFORT ERV D 250 S20	149	704	227	854	947
KOMFORT ERV D 350 S20	149	754	277	1024	1117

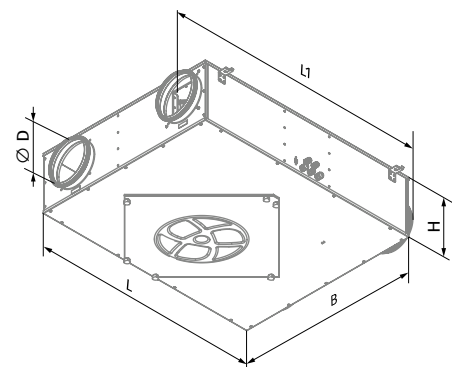

**Technical data**



Parameters	KOMFORT ERV D 150 S20	KOMFORT ERV D 250 S20	KOMFORT ERV D 350 S20
Voltage [V / 50 (60) Hz]	1 ~ 230	1 ~ 230	1 ~ 230
Power [W]	125	250	310
Current [A]	0.6	1.1	1.4
Maximum air flow [m <sup>3</sup> /h (l/s)]	230 (64)	370 (103)	400 (111)
Sound pressure level at 3 m [dBA]	49	52	57
Transported air temperature [°C]	-5...+40	-5...+40	-5...+40
Insulation [mm]	5 - 10	5 - 10	5 - 10
Extract filter	G4	G4	G4
Supply filter	G4 and F8 (PM2.5 93 %)	G4 and F8 (PM2.5 93 %)	G4 and F8 (PM2.5 93 %)
Connected air duct diameter [mm]	100	150	150
Weight [kg]	26	29	42
Heat recovery efficiency [%]*	72-87	66-76	71-87
Humidity recovery efficiency [%]	27-47	22-32	23-40
Heat exchanger type	cross-flow	cross-flow	cross-flow
Heat exchanger material	enthalpy	enthalpy	enthalpy
SEC class	D	E	E
ErP	2016	2016	2016

\*Heat recovery efficiency is specified in compliance with EN 13141-7.

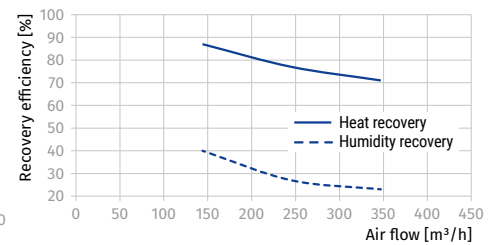
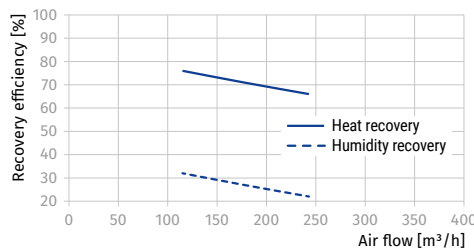
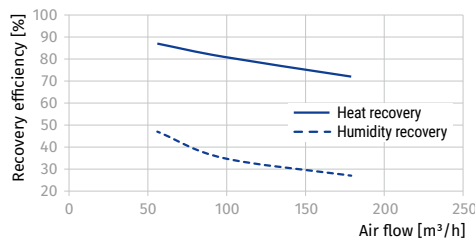
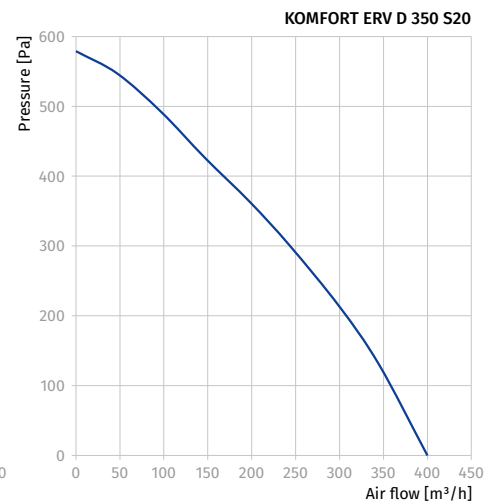
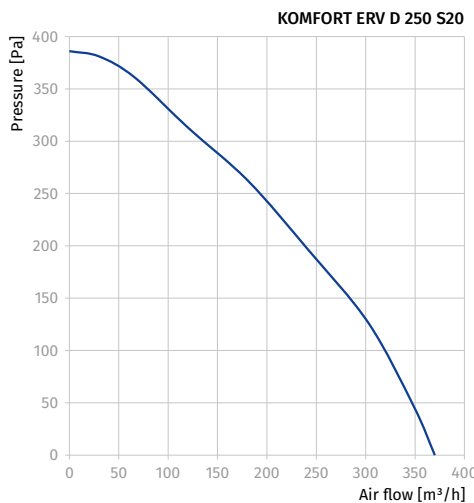
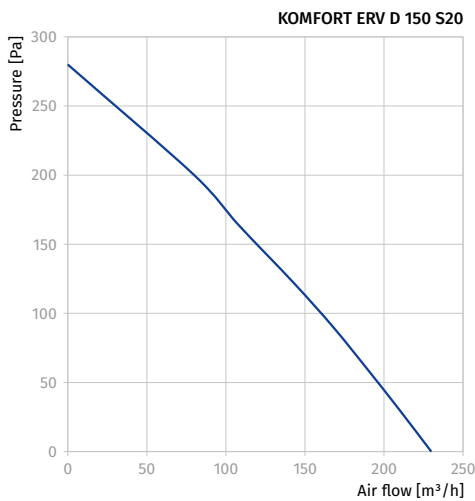
HEAT RECOVERY AIR HANDLING UNITS



**Accessories**

		KOMFORT ERV D 150 S20	KOMFORT ERV D 250 S20	KOMFORT ERV D 350 S20
G4 panel filter		FP 300x220x48 G4	FP 300x220x48 G4	FP 300x270x48 G4
F8 panel filter		FP 300x220x48 F8	FP 300x220x48 F8	FP 300x270x48 F8

# KOMFORT ERV D S3/S4

## Suspended energy recovery air handling units

### Features

- Air handling units for efficient supply and exhaust ventilation in flats, houses, cottages and other buildings.
- Reduction of load for air conditioning systems in hot climate and heat losses in cold climate conditions due to heat and humidity recovery.
- Quality air exchange control for arrangement of comfortable indoor climate.
- Compatible with round Ø 100 or 150 mm air ducts.



**Air flow:**  
up to 500 m<sup>3</sup>/h  
139 l/s



**Heat recovery efficiency:**  
up to 87 %



### Design

- The casing is made of polymer-coated steel panels, internally filled with 5–10 mm thick expanded polyurethane layer.
- The bottom service panel is used to access the filters and the heat exchanger for maintenance operations.
- The spigots are located at the sides of the unit and are equipped with rubber seals for airtight connection to the air ducts.
- The casing is equipped with fixing brackets to suspend the unit to the ceiling.

### Fans

- Asynchronous external rotor motors are used for air supply and exhaust.
- The units are equipped with single-phase three-speed external rotor motors with centrifugal impellers and forward curved blades.
- Integrated motor overheating protection with automatic restart.
- Ball bearings ensure long service life.
- The impellers are dynamically balanced.
- Featured with reliable and low-noise operation.

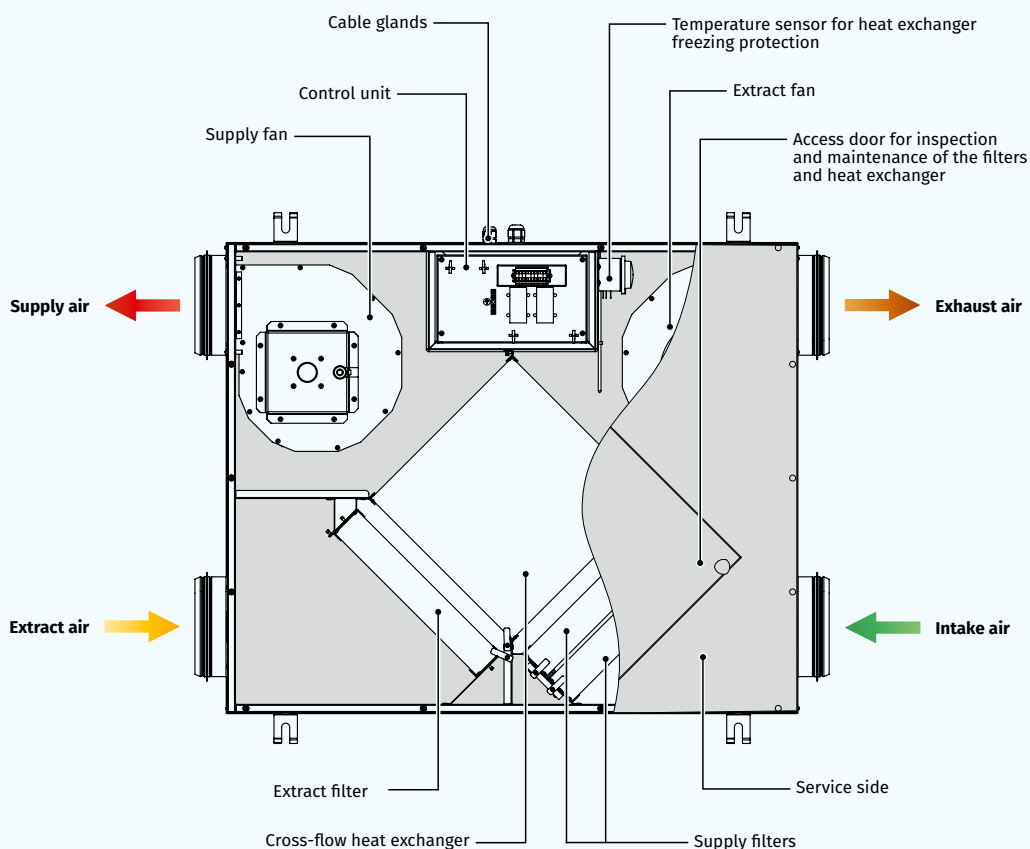

### Air filtration

- Two built-in G4 and F8 filters provide efficient supply air filtration.
- The G4 filter is used for extract air filtration.

### Heat recovery

- The unit is equipped with an enthalpy plate cross-flow heat exchanger for energy (heat and humidity) recovery. Due to humidity recovery condensate is not generated in the enthalpy heat exchanger.
- The air flows are completely separated in the heat exchanger. Thus smells and contaminants are not transferred from the extract air to the supply air.
- Heat recovery is based on heat and/or humidity transfer through the heat exchanger plates. In the cold season supply air is heated in the heat exchanger by transferring the heat energy of warm and humid extract air to the cold fresh air. Heat recovery minimizes ventilation heat losses and heating costs respectively.
- In the warm season the heat exchanger performs reverse and intake air is cooled in the heat exchanger by the cool extract air. That reduces operation load on air conditioners and saves electricity.
- When the indoor and outdoor temperature difference is insignificant, heat recovery is not reasonable. In this case the heat exchanger can be temporary replaced with a summer block for the warm season (available as a specially ordered accessory).



### Control and automation

- The units have integrated control system based on the mechanical three-speed speed switch CDP-3/5 (**KOMFORT ERV D... S3**) or sensor three-speed speed switch SGR-3/1 (**KOMFORT ERV D... S4**), and power cable with mains plug.
- The control unit is integrated in the unit casing.
- The power and ground cables are connected to the control unit via the cable glands on the side of the unit.



### Mounting

- Due to a low casing height the air handling units are a perfect solution for space-restricted installations above suspended ceilings.
- The unit mounting position must provide access for service maintenance.

### FREEZE PROTECTION

- The integrated automatic freeze protection is used to prevent freezing of the heat exchanger in the cold season. The supply fan turns off according to the temperature sensor to get the heat exchanger warmed up with extract air. After that the supply fan turns on and the unit continues to run in the standard mode.

### Designation key

Series	Unit type	Mounting type
KOMFORT	ERV: energy recovery unit	D: suspended mounting, horizontally directed spigots

Rated air flow [m³/h]	Service side	Control
100; 200; 300; 450	R: right L: left	S3: mechanical speed switch CDP-3/5 S4: sensor speed switch SGR-3/1

### Overall dimensions [mm]

Model	∅ D	B	H	L
KOMFORT ERV D 100 S3/S4	100	481	203	600
KOMFORT ERV D 200 S3/S4	100	704	227	854
KOMFORT ERV D 300 S3/S4	150	704	227	854
KOMFORT ERV D 450 S3	150	704	227	1020

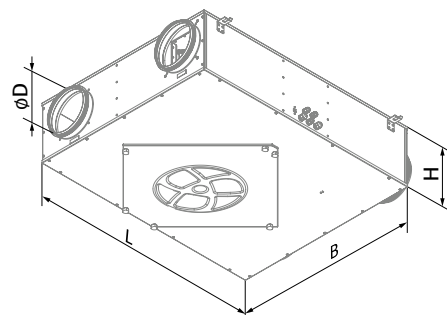

**Technical data**

Parameters	KOMFORT ERV D 100 S3 KOMFORT ERV D 100 S4	KOMFORT ERV D 200 S3 KOMFORT ERV D 200 S4
Voltage [V / 50 Hz]	1~230	1~230
Power [W]	76	141
Current [A]	0.33	0.63
Maximum air flow [m <sup>3</sup> /h (l/s)]	160 (44)	280 (78)
Sound pressure level at 3 m [dBA]	47	49
Transported air temperature [°C]	-5...+40	-5...+40
Insulation	5–10 mm expanded polyurethane	5–10 mm expanded polyurethane
Extract filter	G4	G4
Supply filter	G4 and F8 (PM2.5 > 93 %)	G4 and F8 (PM2.5 > 93 %)
Connected air duct diameter [mm]	100	100
Weight [kg]	17	24
Heat recovery efficiency [%]*	75–87	72–87
Humidity recovery efficiency [%]	32–47	27–47
Heat exchanger type	cross-flow	cross-flow
Heat exchanger material	enthalpy	enthalpy
SEC class	D	D
ErP	2016	2016

\*Heat recovery efficiency is specified in compliance with EN 13141-7.

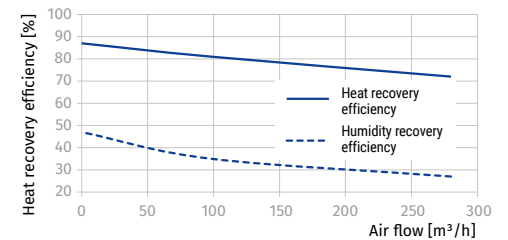
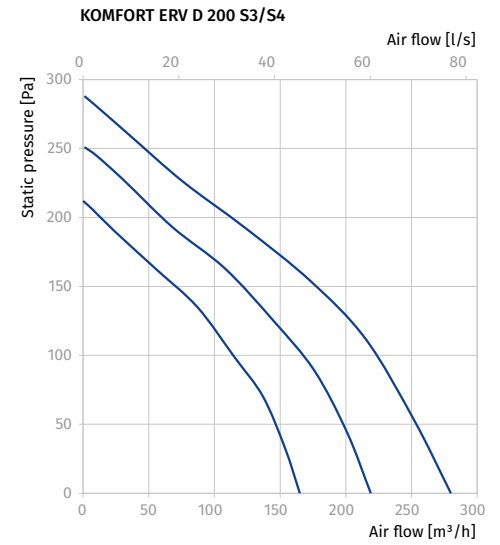
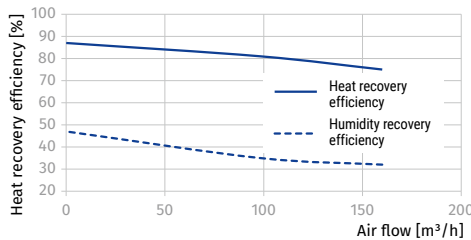
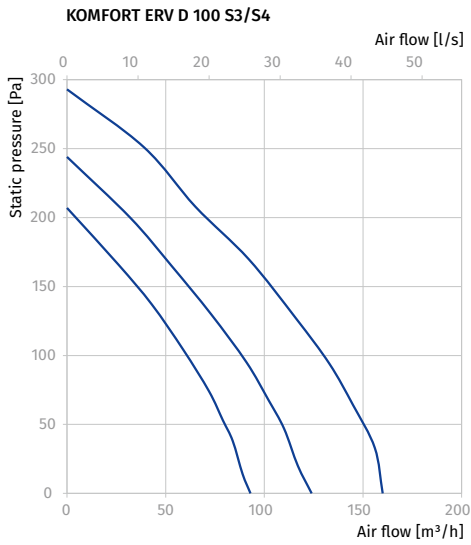

Parameters	KOMFORT ERV D 300 S3 KOMFORT ERV D 300 S4	KOMFORT ERV D 450 S3
Voltage [V / 50 Hz]	1~230	1~230
Power [W]	193	354
Current [A]	0.84	1.54
Maximum air flow [m³/h (l/s)]	340 (94)	500 (139)
Sound pressure level at 3 m [dBA]	52	57
Transported air temperature [°C]	-5...+40	-5...+40
Insulation	5-10 mm expanded polyurethane	5-10 mm expanded polyurethane
Extract filter	G4	G4
Supply filter	G4 and F8 (PM2.5 > 93 %)	G4 and F8 (PM2.5 > 93 %)
Connected air duct diameter [mm]	150	150
Weight [kg]	27	39
Heat recovery efficiency [%]*	66-87	71-87
Humidity recovery efficiency [%]	22-47	23-40
Heat exchanger type	cross-flow	cross-flow
Heat exchanger material	enthalpy	enthalpy
SEC class	E	E
ErP	2016	

\*Heat recovery efficiency is specified in compliance with EN 13141-7.

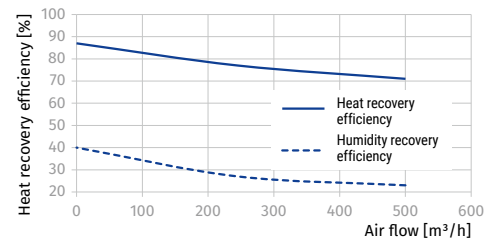
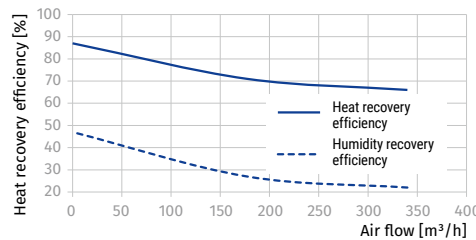
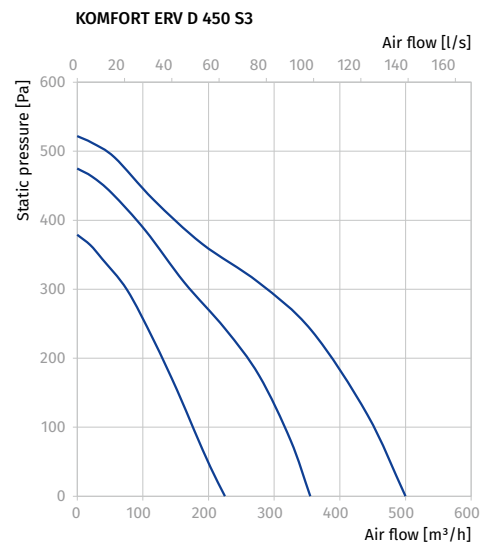
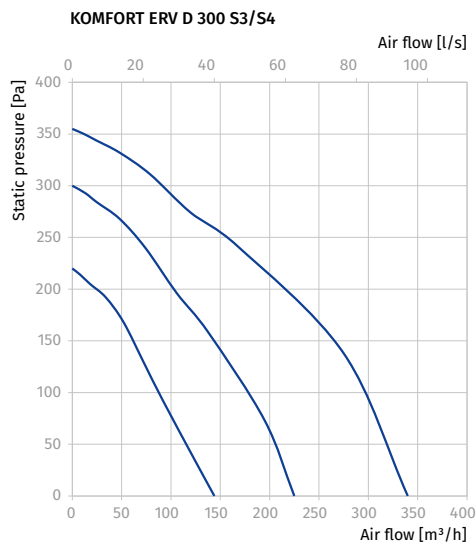

HEAT RECOVERY AIR HANDLING UNITS

### Accessories

		KOMFORT ERV D 100 S3 KOMFORT ERV D 100 S4	KOMFORT ERV D 200 S3 KOMFORT ERV D 200 S4	KOMFORT ERV D 300 S3 KOMFORT ERV D 300 S4	KOMFORT ERV D 450 S3
G4 panel filter		FP 200x191x20 G4	FP 300x220x48 G4	FP 300x220x48 G4	FP 300x270x48 G4
F8 panel filter		FP 200x191x20 F8	FP 300x220x48 F8	FP 300x220x48 F8	FP 300x270x48 F8
Summer block		SB C4 300/220	SB C4 300/220	SB C4 300/270	SB C4 300/270

# KOMFORT EC DBE

## Suspended heat recovery air handling units

### Features

- Air handling units for efficient supply and exhaust ventilation in flats, houses, cottages and other buildings.
- For controllable mechanical energy saving ventilation systems.
- Heat recovery minimises ventilation heat losses.
- Control of air exchange for creating comfortable indoor microclimate.
- Compatible with round Ø 160, 200, 250, 315, 400 mm air ducts.



**Air flow:**  
up to 4300 m<sup>3</sup>/h  
1195 l/s



**Heat recovery efficiency:**  
up to 90 %



### Design

- The casing is made of double-skinned aluzinc panels, internally filled with 20 mm mineral wool layer for heat and sound insulation.
- The casing has fixing brackets with vibration absorbing connectors for easy installation.
- The spigots for connection to the air ducts are located at the side of the unit and are rubber sealed for airtight connection to the air ducts.
- The service panel ensures easy access to the internals for cleaning, filter replacement and other maintenance operations.

#### KOMFORT EC DBE... 300/550/900

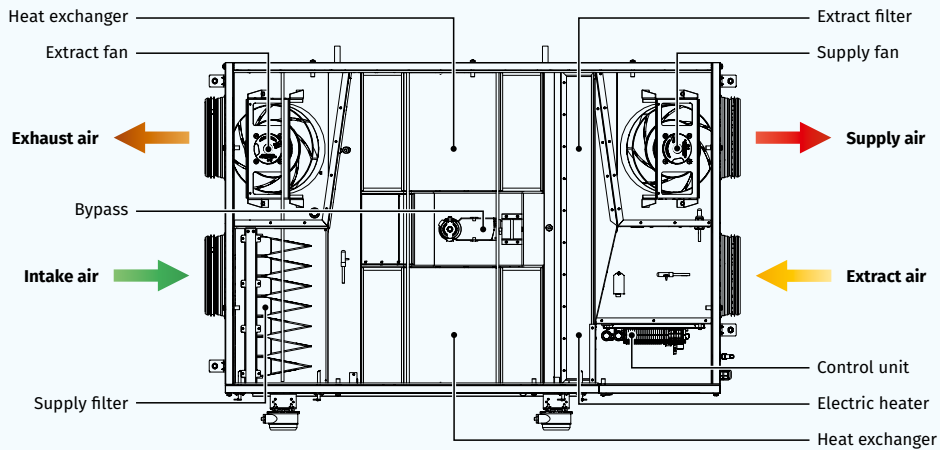

#### KOMFORT EC DBE... 2000/3000

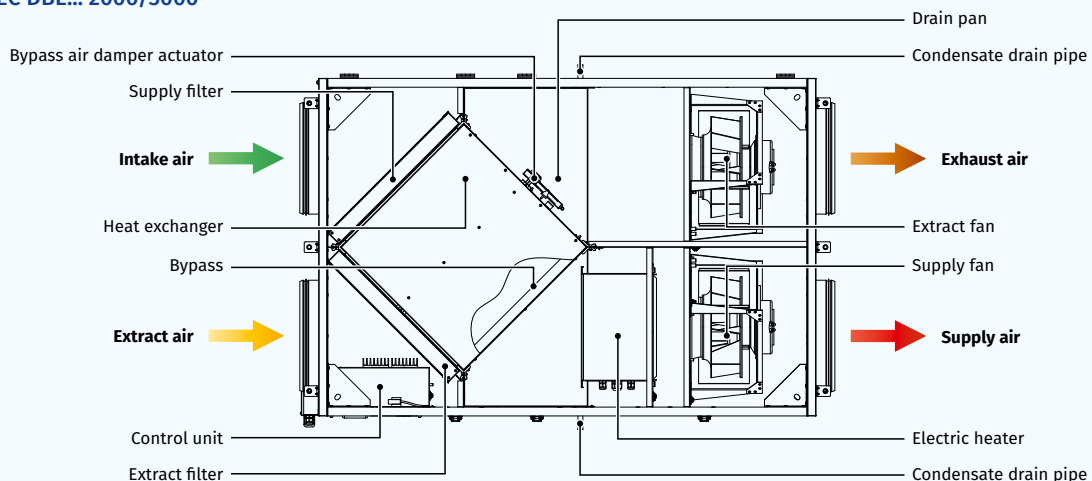



### Fans

- High-efficient external rotor EC motors and centrifugal impellers with backward curved blades are used for air supply and exhaust.
- EC motors have the best power consumption to air flow ratio and meet the latest demands concerning energy saving and high-efficient ventilation.
- EC motors are featured with high performance, low noise level and totally controllable speed range.
- Dynamically balanced impellers.

### Heat recovery

- The **KOMFORT EC DBE 300/550/900** unit is equipped with a plate counter-flow polystyrene heat exchanger for heat recovery. The drain pan located under the heat exchanger is designed for condensate collection and drainage.
- The **KOMFORT EC DBE 2000/3000** unit is equipped with a plate cross-flow aluminum heat exchanger for heat recovery. The drain pan located under the heat exchanger is designed for condensate collection and drainage.
- The **KOMFORT EC DBE...-E 300/550/900** unit is equipped with an enthalpy plate counter-flow heat exchanger for energy (heat and humidity) recovery. Due to humidity recovery condensate is not generated in the enthalpy heat exchanger.

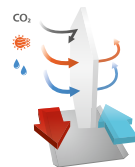

- The air flows are completely separated in the heat exchanger. Thus smells and contaminants are not transferred from the extract air to the supply air.
- Heat recovery is based on heat and/or humidity transfer through the heat exchanger plates. In the cold season supply air is heated in the heat exchanger by transferring the heat energy of warm and humid extract air to the cold fresh air. Heat recovery minimizes ventilation heat losses and heating costs respectively.
- In the warm season the heat exchanger performs reverse and intake air is cooled in the heat exchanger by the cool extract air. That reduces operation load on air conditioners and saves electricity.

### Air heater

- The unit is equipped with an electric heater for operation during cold seasons at low outside temperature.
- The integrated electric heater is activated to warm up supply air flow if set indoor air temperature may not be reached by means of heat recovery only.
- Smooth heat output control ensures automatic supply air temperature maintaining.
- Two integrated overheat protection thermostats, one actuated at +60 °C with automatic restart and the other one actuated at +90 °C with manual restart.

### Bypass

- The units are equipped with a bypass for summer ventilation (room cooling by cool air from outside) and heat exchanger freeze protection.

### Air filtration

- The built-in G4 supply filter and G4 extract filter provide air filtration.
- The F7 supply filter (specially ordered accessory) may be used for efficient supply air filtration.

### Mounting

- Ceiling mounting with fixing brackets.
- The correctly mounted unit must provide free condensate collection and drainage as well as good access for servicing and filter replacement.
- Access for servicing and cleaning the filter: from the right or left side panel, depending on the unit modification.

### Control and automation

- The units are equipped with an S21 integrated automation system. The remote control panel is not included in the delivery set (available separately).
- The S21 controller allows to integrate the unit into the **Smart Home** system or **BMS (Building Management System)**.
- The unit can be controlled by the **Blauberg AHU** mobile application via Wi-Fi.





Download the **Blauberg AHU** app for Android

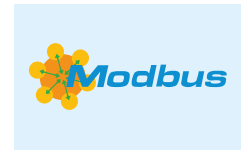

Download the **Blauberg AHU** app for iOS



### Automation functions

Functions	Description
Unit control via Wi-Fi using a mobile application	+
Unit control via a wired remote control panel	S22 control panel (option) 
Unit control via a wireless remote control panel	S22 Wi-Fi control panel (option) 
Unit control via a wired remote LCD control panel	S25 control panel (option) 
BMS (Building Management System)	RS-485 Wi-Fi Ethernet MODBUS (RTU, TCP)
Blauberg Cloud Server service	+
Speed selection	+
Filter replacement indication	by filter timer by filter clogging differential pressure switch (only units with DTV)
Alarm indication	full alarm description in the mobile application
Week-scheduled operation	+
Bypass	automatic manual
Timer	+
Boost mode	+
Fireplace mode	+
Freeze protection	through cyclic stops of the supply fan through preheating (option)
Cooler connection	option
Minimum supply air temperature control	+
Humidity control	option
CO <sub>2</sub> control	option
VOC control	option
PM2.5 control	option
Fire alarm sensor connection	option

Option: function is available when purchasing the appropriate accessory (see the "Accessories" section).

**Designation key**

Series	Motor type	Mounting type	Bypass	Heater type	Rated air flow [m³/h]	Heat exchanger type	Service side	Control	Additional elements
KOMFORT	EC: electronically commutated motor	D: suspended mounting, horizontally directed spigots	B: with a bypass	E: electric heater	300; 550; 900; 2000; 3000	- _: heat recovery E: energy recovery	L: left R: right	S21	_: no additional elements DTV: equipped with a differential pressure switch to control filter contamination

**Overall dimensions [mm]**

Model	Ø D	B	B1	H	L	L1
KOMFORT EC DBE 300(-E) S21	160	485	577	280	1238	1291
KOMFORT EC DBE 550(-E) S21	200	827	960	280	1238	1291
KOMFORT EC DBE 900(-E) S21	250	1351	1485	318	1349	1402
KOMFORT EC DBE 2000 S21	315	950	-	762	1400	1452
KOMFORT EC DBE 3000 S21	400	1265	-	881	1835	1888

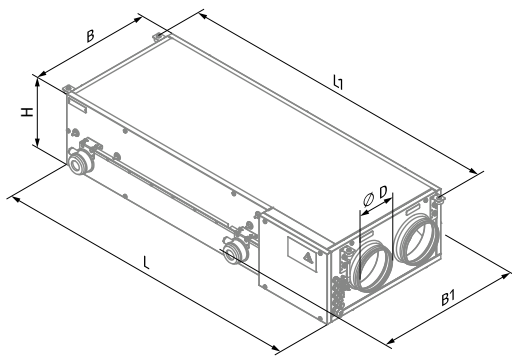

KOMFORT EC DBE 300

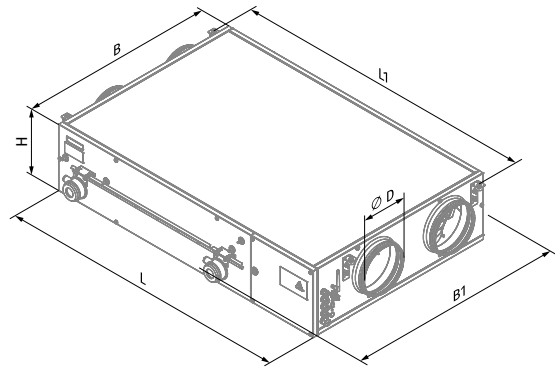

KOMFORT EC DBE 550

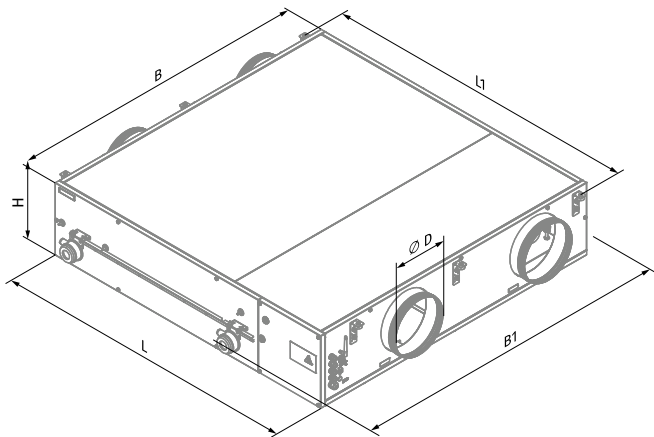

KOMFORT EC DBE 900

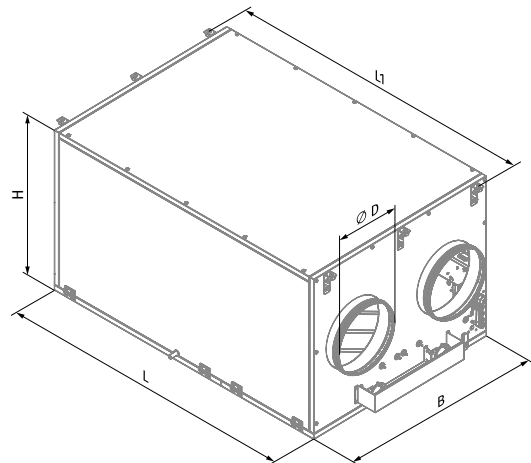

KOMFORT EC DBE 2000 / KOMFORT EC DBE 3000

HEAT RECOVERY AIR HANDLING UNITS

### Technical data

Parameters	KOMFORT EC DBE 300 S21	KOMFORT EC DBE 300-E S21	KOMFORT EC DBE 550 S21	KOMFORT EC DBE 550-E S21	KOMFORT EC DBE 900 S21	KOMFORT EC DBE 900-E S21	KOMFORT EC DBE 2000 S21	KOMFORT EC DBE 3000 S21
Voltage [V / 50 (60) Hz]	1~230	1~230	1~230	1~230	1~230	1~230	3~400	3~400
Max. unit power without electric heater [W]	180	180	297	297	442	442	1063	2226
Max. unit current without electric heater [A]	1.4	1.4	2.4	2.4	3.1	3.1	4.7	3.5
Electric heater power [W]	1500	1500	2000	2000	3300	3300	15000	21000
Electric heater current [A]	6.5	6.5	8.7	8.7	14.3	14.3	21.7	30.0
Max. power with electric heater [W]	1680	1680	2297	2297	3742	3742	16063	23226
Max. current with electric heater [A]	7.9	7.9	11.1	11.1	17.4	17.4	26.4	33.5
Maximum air flow [m³/h (l/s)]	340 (94)	340 (94)	620 (172)	620 (172)	1030 (286)	1030 (286)	2100 (583)	4300 (1195)
Sound pressure level at 3 m [dBA]	27	27	30	30	33	33	36	46
Transported air temperature [°C]	-25...+40	-25...+40	-25...+40	-25...+40	-25...+40	-25...+40	-25...+40	-25...+40
Casing material	aluzinc	aluzinc	aluzinc	aluzinc	aluzinc	aluzinc	aluzinc	aluzinc
Insulation	20 mm, mineral wool	20 mm, mineral wool	20 mm, mineral wool	20 mm, mineral wool	20 mm, mineral wool	20 mm, mineral wool	25 mm, mineral wool	25 mm, mineral wool
Extract filter	G4	G4	G4	G4	G4	G4	G4	G4
Supply filter	G4 (F7 option)	G4 (F7 option)	G4 (F7 option)	G4 (F7 option)	G4 (F7 option)	G4 (F7 option)	G4	G4
Connected air duct diameter [mm]	160	160	200	200	250	250	315	400
Weight [kg]	44	44	67	67	111	111	140	281
Heat recovery efficiency [%]	72-90	69-87	78-90	69-87	75-88	69-85	50-67	59-72
Heat exchanger type	counter-flow	counter-flow	counter-flow	counter-flow	counter-flow	counter-flow	cross-flow	cross-flow
Heat exchanger material	polystyrene	enthalpy	polystyrene	enthalpy	polystyrene	enthalpy	aluminum	aluminum
SEC class	A	A	A	A	A	A	NRVU	NRVU

### KOMFORT EC DBE 300

Sound power level, A-weighted	Total	Octave frequency band [Hz]								LpA 3 m	LpA 1 m
		63	125	250	500	1000	2000	4000	8000		
L <sub>WA</sub> to supply inlet [dBA]	66	13	51	65	54	51	47	37	28		
L <sub>WA</sub> to supply outlet [dBA]	75	14	53	68	65	67	69	64	64		
L <sub>WA</sub> to exhaust inlet [dBA]	62	11	45	61	52	51	48	38	34		
L <sub>WA</sub> to exhaust outlet [dBA]	71	12	47	62	66	61	64	55	61		
L <sub>WA</sub> to environment [dBA]	48	17	30	43	45	36	35	31	35	27	37

Point	Unit power [W]
1	174
2	168
3	152
4	77
5	74
6	68
7	19
8	19
9	18

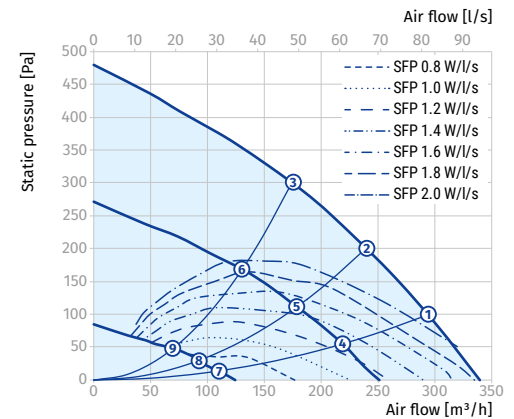

KOMFORT EC DBE 300 S21

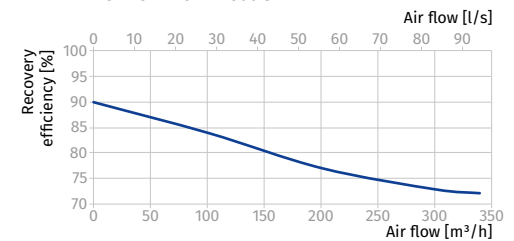

KOMFORT EC DBE 300-E S21

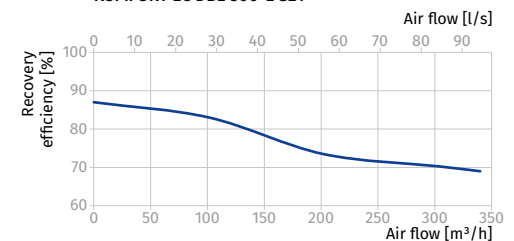

**KOMFORT EC DBE 550**

Sound power level, A-weighted	Total	Octave frequency band [Hz]								LpA 3 m	LpA 1 m
		63	125	250	500	1000	2000	4000	8000		
LWA to supply inlet [dBA]	69	26	60	68	54	53	48	40	29		
LWA to supply outlet [dBA]	76	27	62	71	66	68	68	66	64		
LWA to exhaust inlet [dBA]	69	26	60	68	54	53	48	40	29		
LWA to exhaust outlet [dBA]	66	24	55	65	53	53	49	41	35		
LWA to environment [dBA]	50	29	40	46	46	38	36	34	36	30	40

Data provided for point 1 of the air flow diagram

Point	Unit power [W]
1	294
2	285
3	271
4	109
5	106
6	101
7	34
8	34
9	32

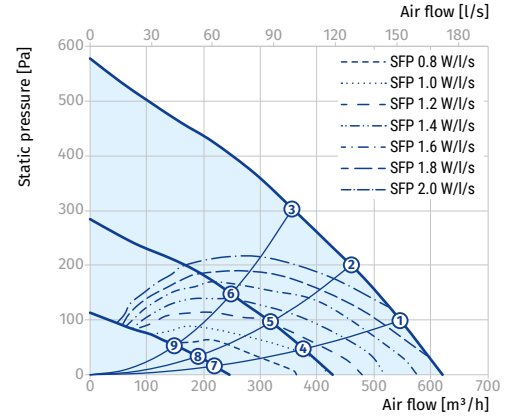

**KOMFORT EC DBE 550 S21**

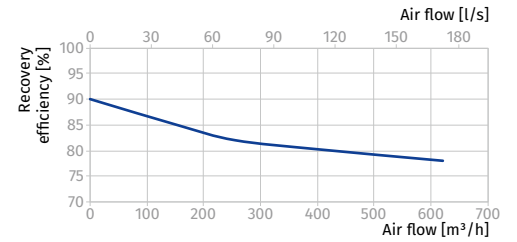

**KOMFORT EC DBE 550-E S21**

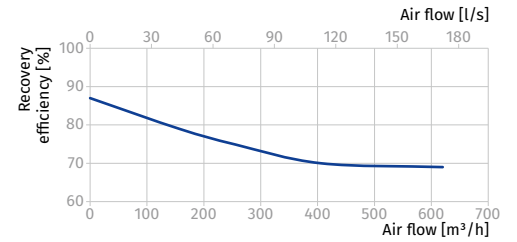

**KOMFORT EC DBE 900**

Sound power level, A-weighted	Total	Octave frequency band [Hz]								LpA 3 m	LpA 1 m
		63	125	250	500	1000	2000	4000	8000		
LWA to supply inlet [dBA]	80	30	64	72	69	74	73	71	71		
LWA to supply outlet [dBA]	70	29	62	69	58	59	53	45	36		
LWA to exhaust inlet [dBA]	78	29	60	69	72	70	71	64	70		
LWA to exhaust outlet [dBA]	69	28	58	68	59	61	56	48	44		
LWA to environment [dBA]	53	33	42	47	49	44	41	39	43	33	43

Point	Unit power [W]
1	442
2	442
3	442
4	160
5	149
6	147
7	46
8	43
9	40

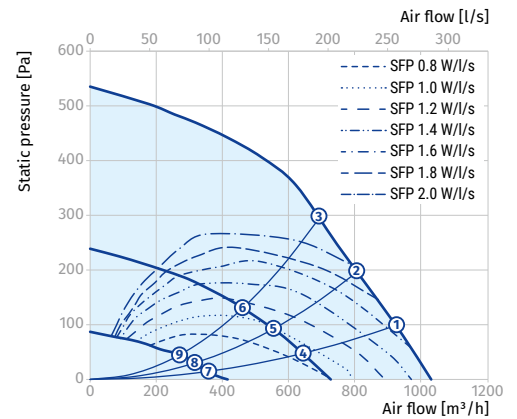

**KOMFORT EC DBE 900 S21**

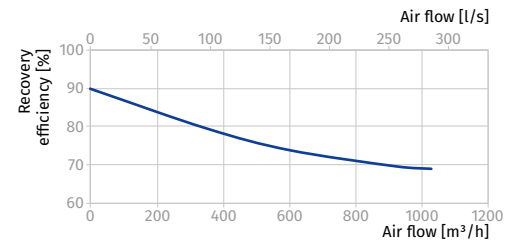

**KOMFORT EC DBE 900-E S21**

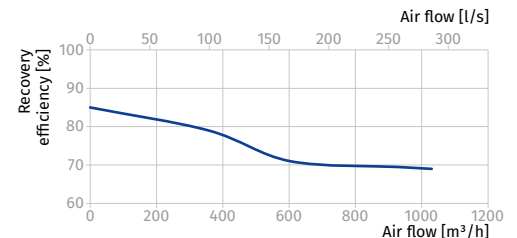

### KOMFORT EC DBE 2000

Sound power level, A-weighted	Total	Octave frequency band [Hz]								LpA 3 m	LpA 1 m
		63	125	250	500	1000	2000	4000	8000		
L <sub>WA</sub> to supply inlet [dBA]	75	37	68	74	61	58	51	43	31		
L <sub>WA</sub> to supply outlet [dBA]	82	38	70	77	73	75	73	70	68		
L <sub>WA</sub> to exhaust inlet [dBA]	72	33	61	71	60	58	53	45	40		
L <sub>WA</sub> to exhaust outlet [dBA]	78	34	63	72	74	68	69	62	67		
L <sub>WA</sub> to environment [dBA]	56	40	47	52	52	43	40	37	40	36	46

Point	Unit power [W]
1	1061
2	1061
3	1062
4	448
5	448
6	447
7	84
8	83
9	83

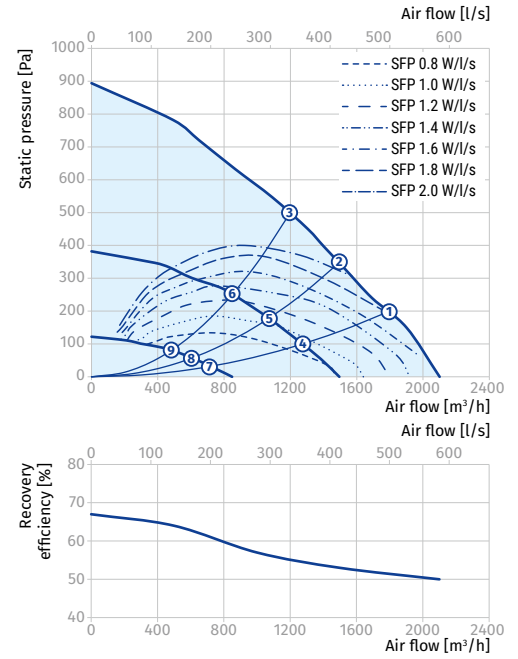







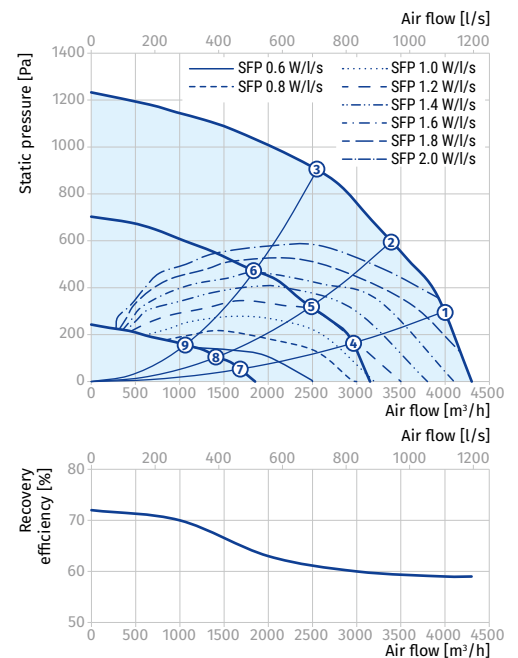









### KOMFORT EC DBE 3000













Sound power level, A-weighted	Total	Octave frequency band [Hz]								LpA 3 m	LpA 1 m
		63	125	250	500	1000	2000	4000	8000		
L <sub>WA</sub> to supply inlet [dBA]	90	48	83	89	72	69	60	50	37		
L <sub>WA</sub> to supply outlet [dBA]	96	49	85	93	87	88	86	83	81		
L <sub>WA</sub> to exhaust inlet [dBA]	86	44	75	85	71	69	62	53	47		
L <sub>WA</sub> to exhaust outlet [dBA]	92	45	78	86	88	81	82	73	80		
L <sub>WA</sub> to environment [dBA]	67	52	58	63	62	51	47	44	47	46	56

Point	Unit power [W]
1	2200
2	2220
3	2143
4	858
5	868
6	840
7	198
8	200
9	162



**Accessories**

		KOMFORT EC DBE 300 S21 KOMFORT EC DBE 300-E S21	KOMFORT EC DBE 550 S21 KOMFORT EC DBE 550-E S21	KOMFORT EC DBE 900 S21 KOMFORT EC DBE 900-E S21
G4 panel filter		FP 440x128x20 G4	FP 782x128x20 G4	FP 647x274x20 G4
G4 pocket filter		FPT 208x236x27 G4	FPT 392x236x27 G4	FPT 647x274x27 G4
F7 pocket filter		FPT 208x236x27 F7	FPT 392x236x27 F7	FPT 647x274x27 F7
Control panel		S22	S22	S22
Wireless control panel		S22 Wi-Fi	S22 Wi-Fi	S22 Wi-Fi
LCD control panel		S25	S25	S25
Humidity sensor		FS2	FS2	FS2
CO <sub>2</sub> sensor with indication		CD-1	CD-1	CD-1
CO <sub>2</sub> sensor		CD-2	CD-2	CD-2
Humidity sensor		HR-S	HR-S	HR-S
Electric preheater		EVH 160 S21 V.2	EVH 200 S21 V.2	EVH 250 S21 V.2
Syphon kit (for the units without an enthalpy heat exchanger)		SFK 20x32	SFK 20x32	SFK 20x32
Silencer		SD 160	SD 200	SD 250
Backdraft air damper		VRV 160	VRV 200	VRV 250
Air damper		VKA 160	VKA 200	VKA 250
Electric actuator		TF230	TF230	TF230

		KOMFORT EC DBE 2000 S21	KOMFORT EC DBE 3000 S21
G4 panel filter		FP 708x480x48 G4	FP 827x741x48 G4
Control panel		S22	S22
Wireless control panel		S22 Wi-Fi	S22 Wi-Fi
LCD control panel		S25	S25
Humidity sensor		FS2	FS2
CO <sub>2</sub> sensor with indication		CD-1	CD-1
CO <sub>2</sub> sensor		CD-2	CD-2
Humidity sensor		HR-S	HR-S
Syphon kit (for the units without an enthalpy heat exchanger)		SFK 20x32	SFK 20x32
Silencer		SD 315	SD 400
Backdraft air damper		VRV 315	VRV 400
Air damper		VKA 315	VKA 400
Electric actuator		TF230	TF230

# KOMFORT EC DBW

## Suspended heat recovery air handling units

### Features

- Air handling units for efficient supply and exhaust ventilation in flats, houses, cottages and other buildings.
- Heat recovery minimises ventilation heat losses.
- Provide controllable air exchange to create the best suitable indoor microclimate.
- Compatible with round Ø 200, 250, 315, 400 mm round air ducts.



**Air flow:**  
up to 4300 m<sup>3</sup>/h  
1195 l/s



**Heat recovery efficiency:**  
up to 90 %



### Design

- The casing is made of double-skinned aluzinc panels, internally filled with 20 mm mineral wool layer for heat and sound insulation.
- The casing has fixing brackets with vibration absorbing connectors for easy installation.
- The spigots for connection to the air ducts are located at the side of the unit and are rubber sealed for airtight connection to the air ducts.
- The service panel ensures easy access to the internals for cleaning, filter replacement and other maintenance operations.

#### KOMFORT EC DBW... 300/550/900

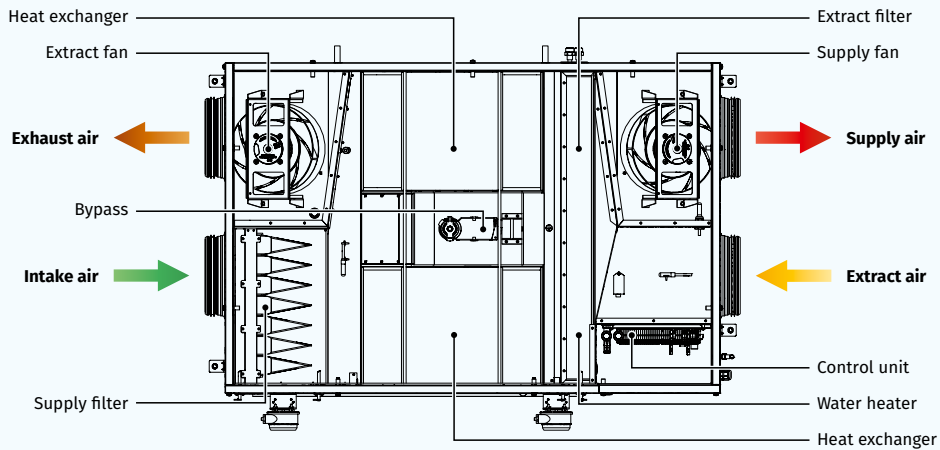

#### KOMFORT EC DBW... 2000/3000

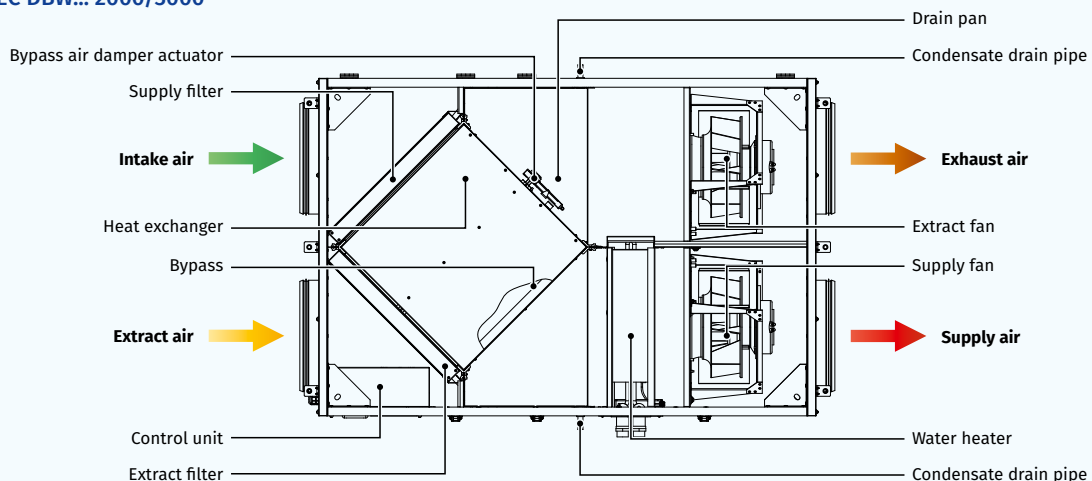



### Fans

- High-efficient external rotor EC motors and centrifugal impellers with backward curved blades are used for air supply and exhaust.
- EC motors have the best power consumption to air flow ratio and meet the latest demands concerning energy saving and high-efficient ventilation.
- EC motors are featured with high performance, low noise level and totally controllable speed range.
- Dynamically balanced impellers.

### Heat recovery

- The **KOMFORT EC DBW 550/900** unit is equipped with a plate counter-flow polystyrene heat exchanger for heat recovery. The drain pan located under the heat exchanger is designed for condensate collection and drainage.
- The **KOMFORT EC DBW 2000/3000** unit is equipped with a plate cross-flow aluminum heat exchanger for heat recovery. The drain pan located under the heat exchanger is designed for condensate collection and drainage.
- The **KOMFORT EC DBW...-E 550/900** unit is equipped with an enthalpy plate counter-flow heat exchanger for energy (heat and humidity) recovery. Due to humidity recovery condensate is not generated in the enthalpy heat exchanger.



- The air flows are completely separated in the heat exchanger. Thus smells and contaminants are not transferred from the extract air to the supply air.
- Heat recovery is based on heat and/or humidity transfer through the heat exchanger plates. In the cold season supply air is heated in the heat exchanger by transferring the heat energy of warm and humid extract air to the cold fresh air. Heat recovery minimizes ventilation heat losses and heating costs respectively.
- In the warm season the heat exchanger performs reverse and intake air is cooled in the heat exchanger by the cool extract air. That reduces operation load on air conditioners and saves electricity.

### Air heater

- The unit is equipped with a water (glycol) heater for operation at low outside air temperature.
- The integrated water heater is activated to warm up supply air flow if set indoor air temperature may not be reached by means of heat recovery only.
- Heat medium temperature control ensures supply air temperature maintaining.
- The air temperature sensor downstream of the waterheating coils and the return water temperature sensor are used for freezing protection of the water heater.

### Bypass

- The units are equipped with a bypass for summer ventilation (room cooling by cool air from outside) and heat exchanger freeze protection.

### Air filtration

- The built-in G4 supply filter and G4 extract filter provide air filtration.
- The F7 supply filter (specially ordered accessory) may be used for efficient supply air filtration.

### Mounting

- Mounting to the ceiling with fixing brackets.
- The correctly mounted unit must provide free condensate collection and drainage as well as good access for servicing and filter replacement.
- Access for servicing and cleaning the filter: from the right or left side panel, depending on the unit modification.

### Control and automation

- The units are equipped with an S21 integrated automation system. The remote control panel is not included in the delivery set (available separately).
- The S21 controller allows to integrate the unit into the **Smart Home** system or **BMS (Building Management System)**.
- The unit can be controlled by the **Blauberg AHU** mobile application via Wi-Fi.





Download the **Blauberg AHU** app for Android

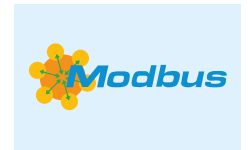

Download the **Blauberg AHU** app for iOS



### Automation functions

Functions	Description
Unit control via Wi-Fi using a mobile application	+
Unit control via a wired remote control panel	S22 control panel (option) 
Unit control via a wireless remote control panel	S22 Wi-Fi control panel (option) 
Unit control via a wired remote LCD control panel	S25 control panel (option) 
BMS (Building Management System)	RS-485 Wi-Fi Ethernet MODBUS (RTU, TCP)
Blauberg Cloud Server service	+
Speed selection	+
Filter replacement indication	by filter timer by filter clogging differential pressure switch (only units with DTV)
Alarm indication	full alarm description in the mobile application
Week-scheduled operation	+
Bypass	automatic manual
Timer	+
Boost mode	+
Fireplace mode	+
Freeze protection	through cyclic stops of the supply fan through preheating (option)
Cooler connection	option
Minimum supply air temperature control	+
Humidity control	option
CO <sub>2</sub> control	option
VOC control	option
PM2.5 control	option
Fire alarm sensor connection	option

Option: function is available when purchasing the appropriate accessory (see the "Accessories" section).

### Designation key

Series	Motor type	Mounting type	Bypass	Heater type	Rated air flow [m³/h]	Heat exchanger type	Service side	Control	Additional elements
KOMFORT	EC: electronically commutated motor	D: suspended mounting, horizontally directed spigots	B: with a bypass	W: water heater	550; 900; 2000; 3000	- _: heat recovery E: energy recovery	L: left R: right	S21	_: no additional elements DTV: equipped with a differential pressure switch to control filter contamination

### Overall dimensions [mm]

Model	∅ D	B	B1	H	L	L1
KOMFORT EC DBW 550(-E) S21	199	827	960	283	1238	1286
KOMFORT EC DBW 900(-E) S21	249	1350	1485	317	1346	1395
KOMFORT EC DBW 2000 S21	315	950	-	761	1400	1453
KOMFORT EC DBW 3000 S21	400	1265	-	881	1835	1888

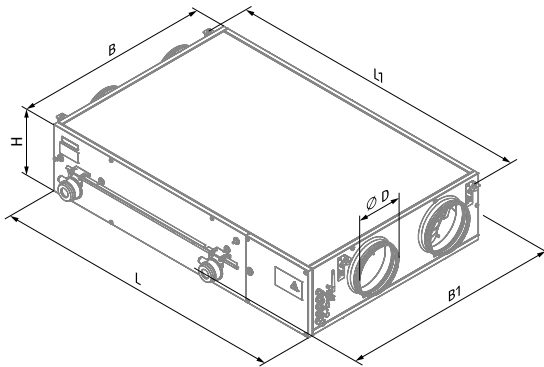

KOMFORT EC DBW 550

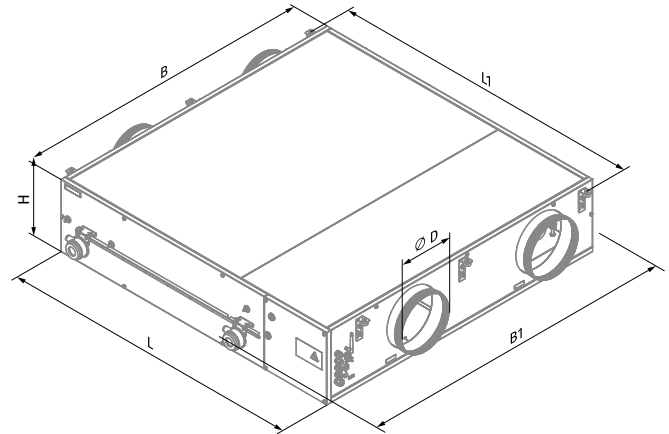

KOMFORT EC DBW 900

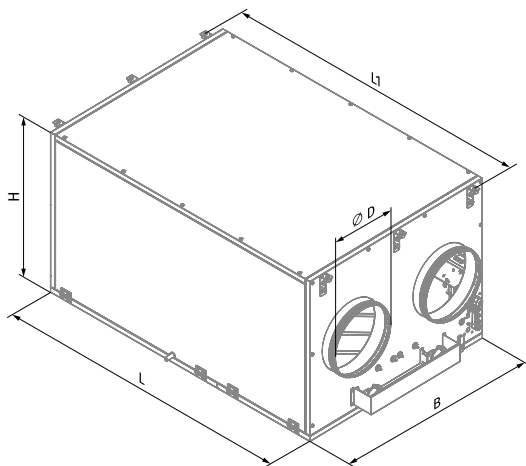

KOMFORT EC DBW 2000 / KOMFORT EC DBW 3000

### Technical data

Parameters	KOMFORT EC DBW 550 S21	KOMFORT EC DBW 550-E S21	KOMFORT EC DBW 900 S21	KOMFORT EC DBW 900-E S21	KOMFORT EC DBW 2000 S21	KOMFORT EC DBW 3000 S21
Voltage [V / 50 (60) Hz]	1~230	1~230	1~230	1~230	1~230	3~400
Max. unit power [W]	297	297	442	442	1063	2226
Max. unit current [A]	2.4	2.4	3	3	4.7	3.5
Number of water (glycol) coil rows	2	2	2	2	2	2
Maximum air flow [m³/h (l/s)]	620 (172)	620 (172)	1030 (286)	1030 (286)	2100 (583)	4300 (1195)
Sound pressure level at 3 m [dBA]	30	30	33	33	36	46
Transported air temperature [°C]	-25...+40	-25...+40	-25...+40	-25...+40	-25...+40	-25...+40
Casing material	aluzinc	aluzinc	aluzinc	aluzinc	aluzinc	aluzinc
Insulation	20 mm, mineral wool	20 mm, mineral wool	20 mm, mineral wool	20 mm, mineral wool	25 mm, mineral wool	25 mm, mineral wool
Extract filter	G4	G4	G4	G4	G4	G4
Supply filter	G4 (F7 option)	G4 (F7 option)	G4 (F7 option)	G4 (F7 option)	G4	G4
Connected air duct diameter [mm]	200	200	250	250	315	400
Weight [kg]	68	68	112	112	140	268
Heat recovery efficiency [%]	78-90	69-87	75-88	69-85	50-67	59-72
Heat exchanger type	counter-flow	counter-flow	counter-flow	counter-flow	cross-flow	cross-flow
Heat exchanger material	polystyrene	enthalpy	polystyrene	enthalpy	aluminum	aluminum
SEC class	A	A	A	A	NRVU	NRVU

### KOMFORT EC DBW 550

Sound power level, A-weighted	Total	Octave frequency band [Hz]								LpA 3 m	LpA 1 m
		63	125	250	500	1000	2000	4000	8000		
L <sub>WA</sub> to supply inlet [dBA]	69	26	60	68	54	53	48	40	29		
L <sub>WA</sub> to supply outlet [dBA]	76	27	62	71	66	68	68	66	64		
L <sub>WA</sub> to exhaust inlet [dBA]	69	26	60	68	54	53	48	40	29		
L <sub>WA</sub> to exhaust outlet [dBA]	66	24	55	65	53	53	49	41	35		
L <sub>WA</sub> to environment [dBA]	50	29	40	46	46	38	36	34	36	30	40

Point	Unit power [W]
1	294
2	285
3	271
4	109
5	106
6	101
7	34
8	34
9	32

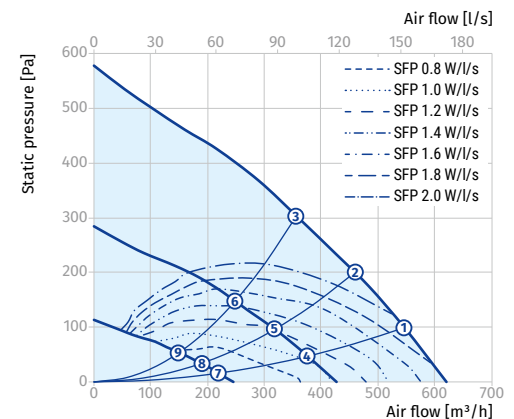

KOMFORT EC DBW 550 S21

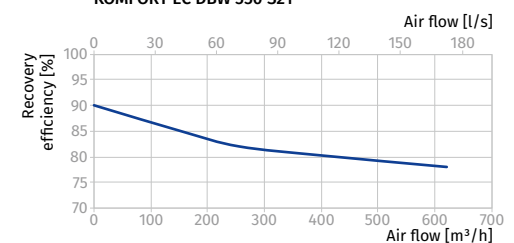

KOMFORT EC DBW 550-E S21

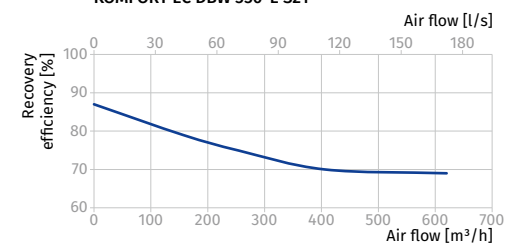

**KOMFORT EC DBW 900**

Sound power level, A-weighted	Total	Octave frequency band [Hz]								LpA 3 m	LpA 1 m
		63	125	250	500	1000	2000	4000	8000		
LWA to supply inlet [dBA]	80	30	64	72	69	74	73	71	71		
LWA to supply outlet [dBA]	70	29	62	69	58	59	53	45	36		
LWA to exhaust inlet [dBA]	78	29	60	69	72	70	71	64	70		
LWA to exhaust outlet [dBA]	69	28	58	68	59	61	56	48	44		
LWA to environment [dBA]	53	33	42	47	49	44	41	39	43	33	43

Point	Unit power [W]
1	442
2	442
3	442
4	160
5	149
6	147
7	46
8	43
9	40

**KOMFORT EC DBW 2000**

Sound power level, A-weighted	Total	Octave frequency band [Hz]								LpA 3 m	LpA 1 m
		63	125	250	500	1000	2000	4000	8000		
LWA to supply inlet [dBA]	75	37	68	74	61	58	51	43	31		
LWA to supply outlet [dBA]	82	38	70	77	73	75	73	70	68		
LWA to exhaust inlet [dBA]	72	33	61	71	60	58	53	45	40		
LWA to exhaust outlet [dBA]	78	34	63	72	74	68	69	62	67		
LWA to environment [dBA]	56	40	47	52	52	43	40	37	40	36	46

Point	Unit power [W]
1	1061
2	1061
3	1062
4	448
5	448
6	447
7	84
8	83
9	83

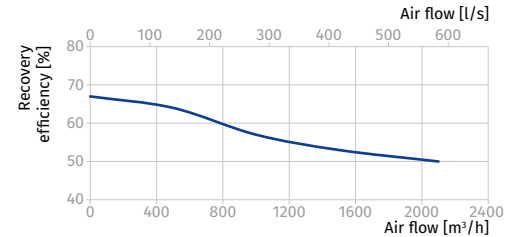
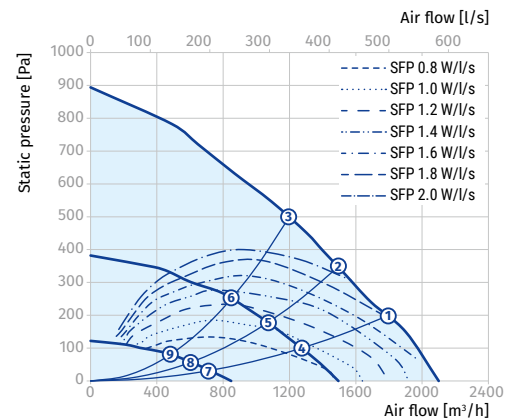
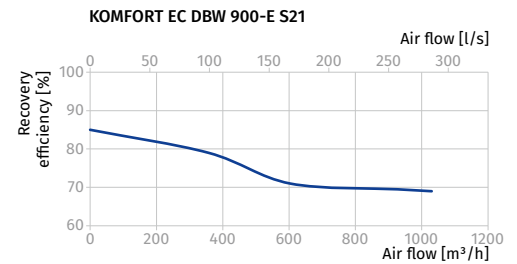
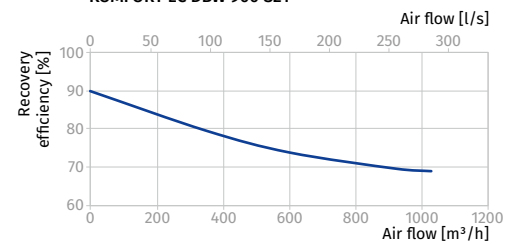
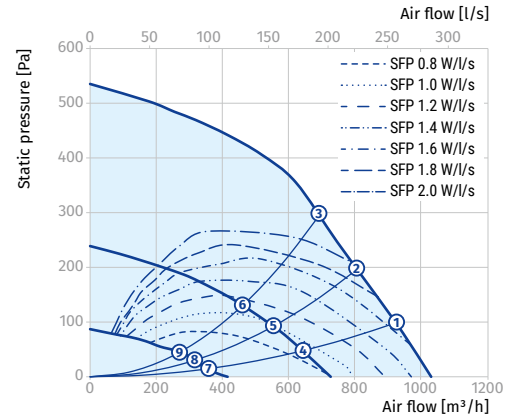

### KOMFORT EC DBW 3000

Sound power level, A-weighted	Total	Octave frequency band [Hz]								LpA 3 m	LpA 1 m
		63	125	250	500	1000	2000	4000	8000		
L <sub>WA</sub> to supply inlet [dBA]	90	48	83	89	72	69	60	50	37		
L <sub>WA</sub> to supply outlet [dBA]	96	49	85	93	87	88	86	83	81		
L <sub>WA</sub> to exhaust inlet [dBA]	86	44	75	85	71	69	62	53	47		
L <sub>WA</sub> to exhaust outlet [dBA]	92	45	78	86	88	81	82	73	80		
L <sub>WA</sub> to environment [dBA]	67	52	58	63	62	51	47	44	47	46	56

Point	Unit power [W]
1	2200
2	2220
3	2143
4	858
5	868
6	840
7	198
8	200
9	162

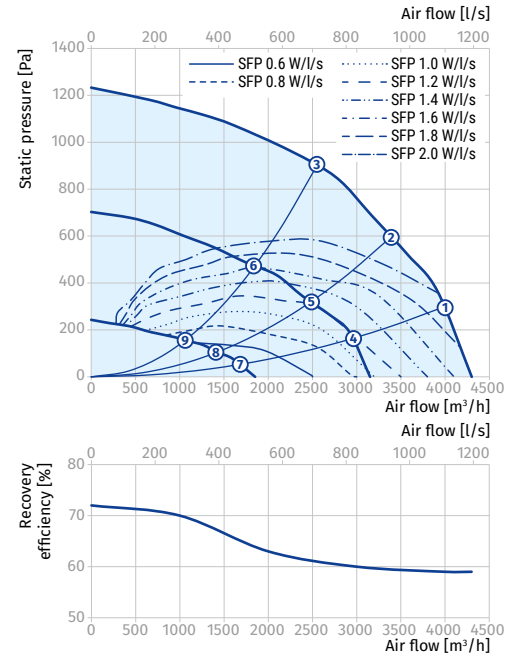

## Hot water coil calculation diagram

### KOMFORT EC DBW 550

Air temperature downstream of the water heating coils [°C]

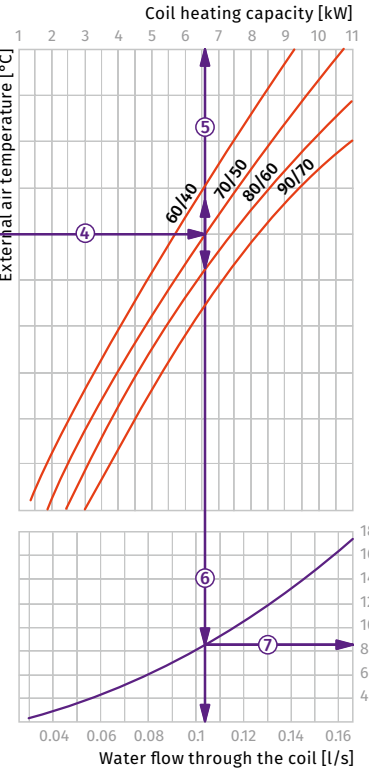
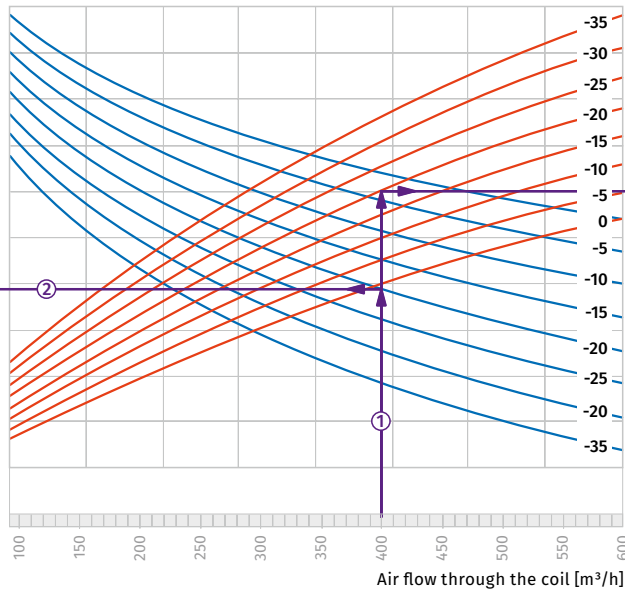
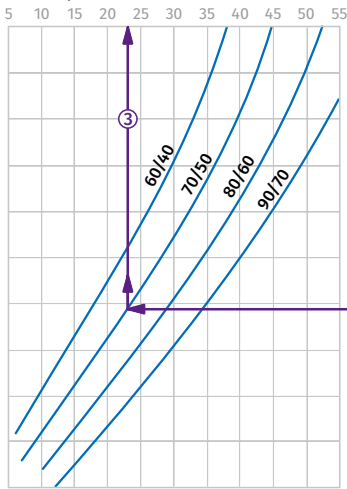

#### How to use water heater diagrams.

Sample parameters: Air flow = 400 m<sup>3</sup>/h.  
Outside air temperature = -20 °C.  
Water temperature (in/out) = +70/+50 °C.

- To calculate the maximum air temperature, find the intersection point of the air flow line (e.g., 400 m<sup>3</sup>/h) ① with the rated outer temperature shown in blue line (e.g., -20 °C) and draw the line ② to the left until it crosses the water in/out temperature curve (e.g., +70/+50). From this point draw a vertical line to the supply air temperature downstream of the heater (+23 °C) ③.

- To calculate the heater power, find the intersection point of the air flow ① with the rated winter temperature shown in red line (e.g., -20 °C) and draw the line ④ to the right until it crosses the water in/out temperature curve (e.g., +70/+50). From this point draw a vertical line to the heater power axis (6.6 kW) ⑤.
- To calculate the required water flow in the heater, prolong this line ⑥ downwards to the water flow axis (0.105 l/s).
- To calculate the water pressure drop in the heater, find the intersection point of the line ⑥ with the pressure loss curve and prolong the line ⑦ to the right on the water pressure drop axis (8.5 kPa).

### KOMFORT EC DBW 900

Air temperature downstream of the water heating coils [°C]

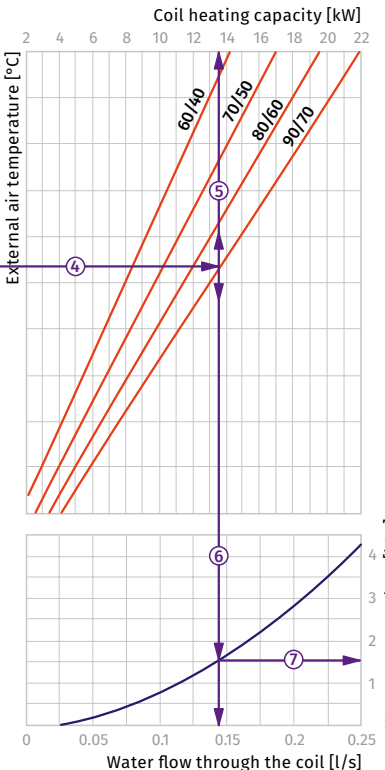
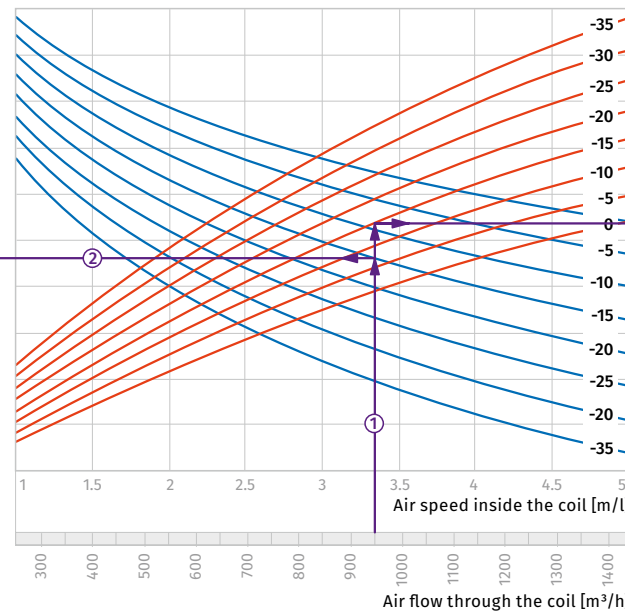
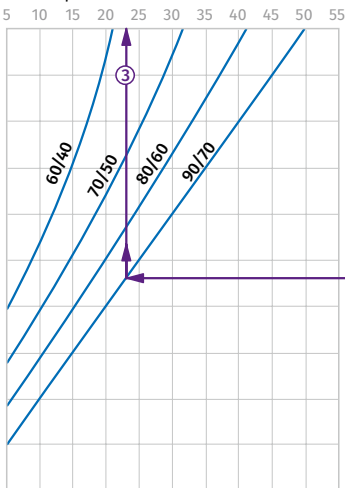

#### How to use water heater diagrams.

Sample parameters: Air flow = 950 m<sup>3</sup>/h.  
Outside air temperature = -15 °C.  
Water temperature (in/out) = +90/+70 °C.  
The air flow is 950 m<sup>3</sup>/h and the air speed in the heater is 3.35 m/s ①.

- To calculate the maximum air temperature, find the intersection point of the air flow line ① with the rated outer temperature shown in blue line (e.g., -15 °C) and draw the line ② to the left until it crosses the water in/out temperature curve (e.g., +90/+70). From this point draw a vertical line to the supply air temperature downstream of the heater (+23 °C) ③.

- To calculate the heater power, find the intersection point of the air flow ① with the rated winter temperature shown in red line (e.g., -15 °C) and draw the line ④ to the right until it crosses the water in/out temperature curve (e.g., +90/+70). From this point draw a vertical line to the heater power axis (13.5 kW) ⑤.
- To calculate the required water flow in the heater, prolong this line ⑥ downwards to the water flow axis (0.14 l/s).
- To calculate the water pressure drop in the heater, find the intersection point of the line ⑥ with the pressure loss curve and prolong the line ⑦ to the right on the water pressure drop axis (1.5 kPa).

### KOMFORT EC DBW 2000

Air temperature downstream of the water heating coils [°C]

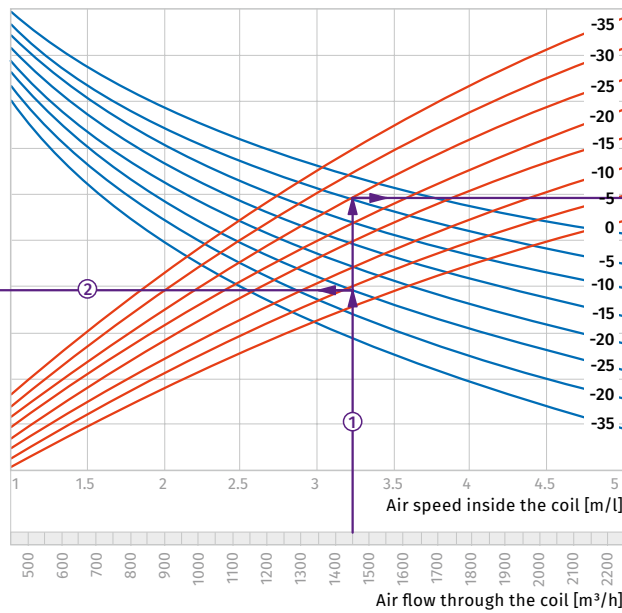
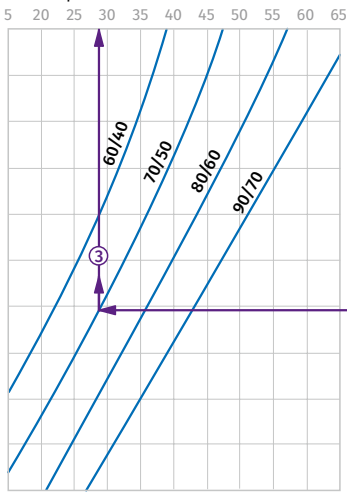

Coil heating capacity [kW]

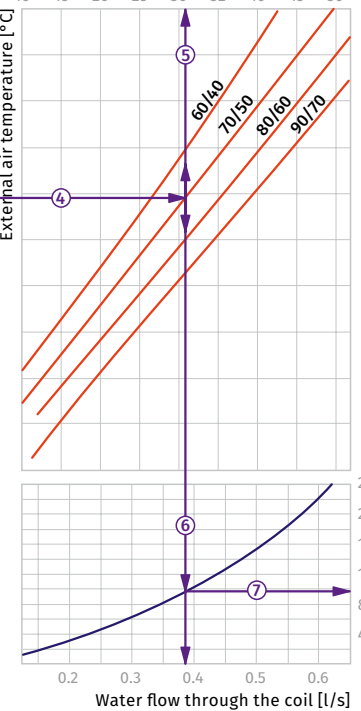

**How to use water heater diagrams.**

Sample parameters: Air flow = 1450 m<sup>3</sup>/h.  
 Outside air temperature = -25 °C.  
 Water temperature (in/out) = +70/+50 °C.  
 The air flow is 1450 m<sup>3</sup>/h and the air speed in the heater is 3.2 m/s ①.

- To calculate the maximum air temperature find the intersection point of the air flow line ① with the rated outer temperature shown in blue line (e.g., -25 °C) and draw the line ② to the left until it crosses the water in/out temperature curve (e.g., +70/+50). From this point draw a vertical line to the supply air temperature downstream of the heater (+28 °C) ③.

- To calculate the heater power find the intersection point of the air flow ① with the rated winter temperature shown in red line (e.g., -25 °C) and draw the line ④ to the right until it crosses the water in/out temperature curve (e.g., +70/+50). From this point draw a vertical line to the heater power axis (31.0 kW) ⑤.
- To calculate the required water flow in the heater prolong this line ⑥ downwards to the water flow axis (0.38 l/s).
- To calculate the water pressure drop in the heater find the intersection point of the line ⑥ with the pressure loss curve and prolong the line ⑦ to the right on the water pressure drop axis (9.8 kPa).

### KOMFORT EC DBW 3000

Air temperature downstream of the water heating coils [°C]

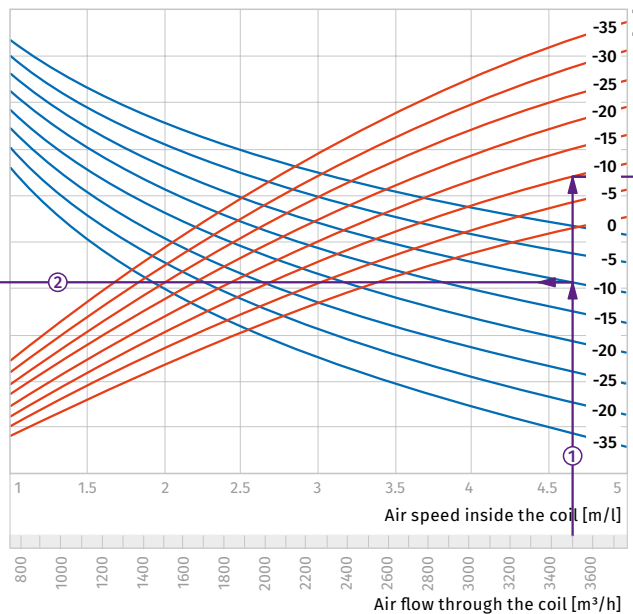
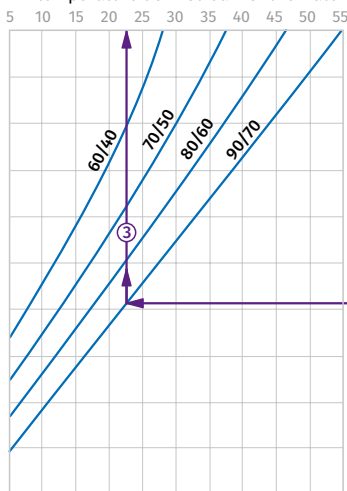

Coil heating capacity [kW]

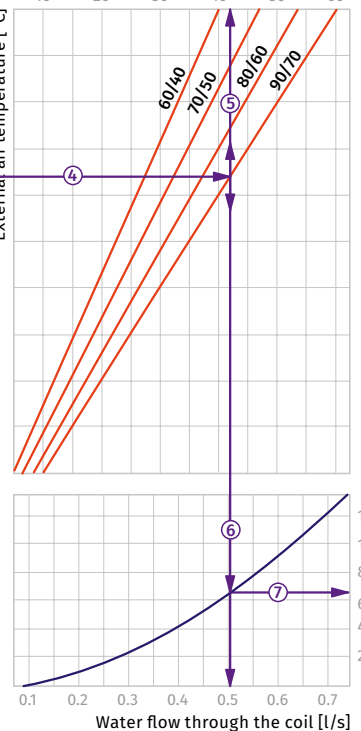

















**How to use water heater diagrams.**

Sample parameters: Air flow = 3500 m<sup>3</sup>/h.  
 Outside air temperature = -10 °C.  
 Water temperature (in/out) = +90/+70 °C.  
 The air flow is 3500 m<sup>3</sup>/h and the air speed in the heater is 4.65 m/s ①.















- To calculate the maximum air temperature find the intersection point of the air flow line ① with the rated outer temperature shown in blue line (e.g., -10 °C) and draw the line ② to the left until it crosses the water in/out temperature curve (e.g., +90/+70). From this point draw a vertical line to the supply air temperature downstream of the heater (+22.5 °C) ③.

- To calculate the heater power find the intersection point of the air flow ① with the rated winter temperature shown in red line (e.g., -10 °C) and draw the line ④ to the right until it crosses the water in/out temperature curve (e.g., +90/+70). From this point draw a vertical line to the heater power axis (42.0 kW) ⑤.
- To calculate the required water flow in the heater prolong this line ⑥ downwards to the water flow axis (0.5 l/s).
- To calculate the water pressure drop in the heater find the intersection point of the line ⑥ with the pressure loss curve and prolong the line ⑦ to the right on the water pressure drop axis (6.5 kPa).

**Accessories**

		KOMFORT EC DBW 550 S21 KOMFORT EC DBW 550-E S21	KOMFORT EC DBW 900 S21 KOMFORT EC DBW 900-E S21
G4 panel filter		FP 782x128x20 G4	FP 647x274x20 G4
G4 pocket filter		FPT 392x236x27 G4	FPT 647x274x27 G4
F7 pocket filter		FPT 392x236x27 F7	FPT 647x274x27 F7
Control panel		S22	S22
Wireless control panel		S22 Wi-Fi	S22 Wi-Fi
LCD control panel		S25	S25
Humidity sensor		FS2	FS2
CO <sub>2</sub> sensor with indication		CD-1	CD-1
CO <sub>2</sub> sensor		CD-2	CD-2
Humidity sensor		HR-S	HR-S
Electric preheater		EVH 200 S21 V.2	EVH 250 S21 V.2
Syphon kit (for the units without an enthalpy heat exchanger)		SFK 20x32	SFK 20x32
Silencer		SD 200	SD 250
Backdraft air damper		VRV 200	VRV 250
Air damper		VKA 200	VKA 250
Electric actuator		TF230	TF230
Water mixing unit		WMG	WMG



		KOMFORT EC DBW 2000 S21	KOMFORT EC DBW 3000 S21
G4 panel filter		FP 708x480x48 G4	FP 827x741x48 G4
Control panel		S22	S22
Wireless control panel		S22 Wi-Fi	S22 Wi-Fi
LCD control panel		S25	S25
Humidity sensor		FS2	FS2
CO <sub>2</sub> sensor with indication		CD-1	CD-1
CO <sub>2</sub> sensor		CD-2	CD-2
Humidity sensor		HR-S	HR-S
Syphon kit (for the units without an enthalpy heat exchanger)		SFK 20x32	SFK 20x32
Silencer		SD 315	-
Backdraft air damper		VRV 315	VRV 400
Air damper		VKA 315	VKA 400
Electric actuator		TF230	TF230
Water mixing unit		WMG	WMG

# KOMFORT EC LB(E)

## Heat recovery air handling units

### Features

- Air handling units for efficient supply and exhaust ventilation in flats, houses, cottages and other buildings.
- Used to create controlled energy-saving ventilation systems.
- The heat recovery technology is used to minimize ventilation heat losses.
- Control of air exchange for creating comfortable indoor microclimate.
- Compatible with round Ø 160, 200 or 250 mm air ducts.



**Air flow:**  
up to 830 m<sup>3</sup>/h  
231 l/s



**Heat recovery efficiency:**  
up to 98 %



### Design

- The casing is made of double-skinned aluzinc panels, internally filled with mineral wool layer 40 mm for heat- and sound-insulation.
- The casing has mounting brackets with anti-vibration rubber mounts for easy installation.
- The unit is equipped with service hatches on the side panels for easy maintenance of filters. This design enables the left-hand and right-hand installation of the unit.
- The spigots are located at the sides of the unit and are equipped with rubber seals for airtight connection to the air ducts.

### Fans

- High-efficient external rotor EC motors and centrifugal impellers are used for air supply and exhaust.
- The forward curved blades in **KOMFORT EC LB(E) 300/LB(E) 400** provide permanent air flow.
- The **KOMFORT EC LB(E) 700** model has impellers with backward curved blades.
- EC motors have the best power consumption to air capacity ratio and meet the latest demands concerning energy saving and high-efficient ventilation.
- EC motors are featured with high performance, low noise level and totally controllable speed range.
- The impellers are dynamically balanced.

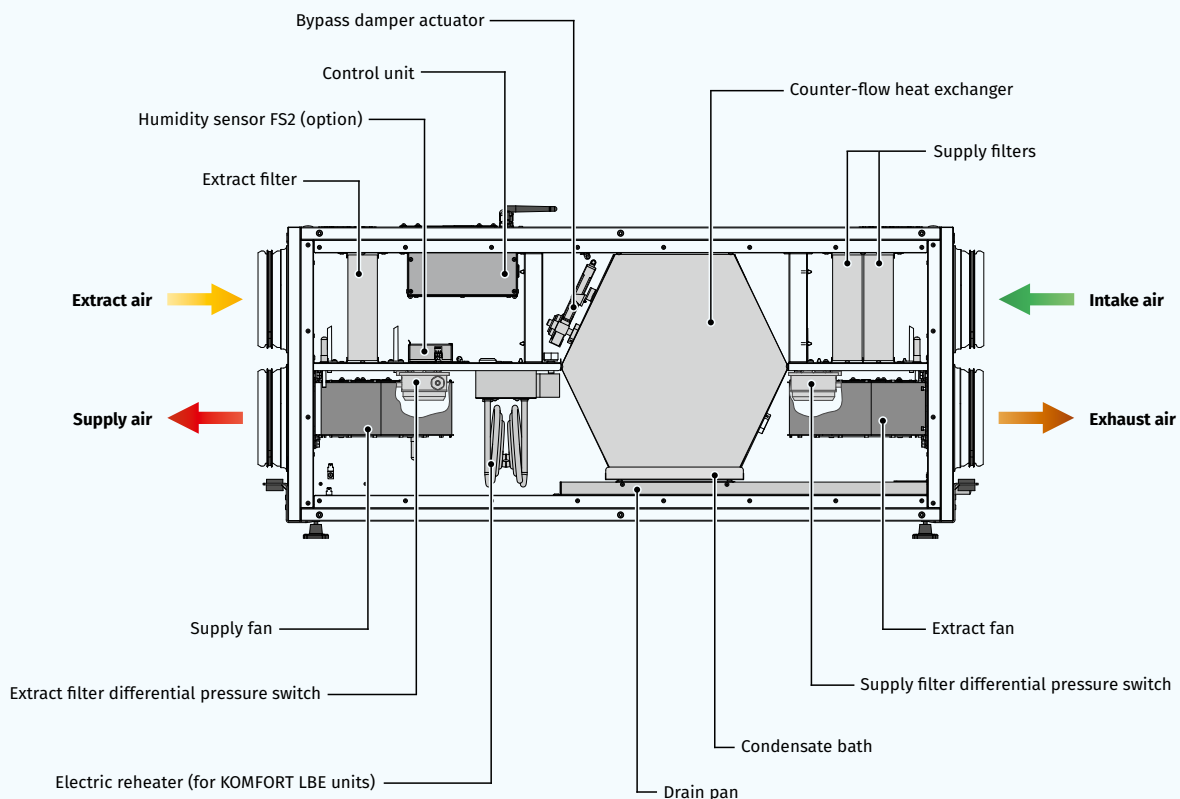

### Heat recovery

- o The **KOMFORT EC LB(E)...** unit is equipped with a plate counter-flow polystyrene heat exchanger for heat recovery. The unit condensate is collected and drained to the drain pan under the heat exchanger.



- o The **KOMFORT EC LB(E)....-E** unit is equipped with an enthalpy plate counter-flow heat exchanger for energy (heat and humidity) recovery. Due to humidity recovery condensate is not generated in the enthalpy heat exchanger.



- o The air flows are completely separated in the heat exchanger. Thus smells and contaminants are not transferred from the extract air to the supply air.
- o Heat recovery is based on heat and/or humidity transfer through the heat exchanger plates. In the cold season supply air is heated in the heat exchanger by transferring the heat energy of warm and humid extract air to the cold fresh air. Heat recovery minimizes ventilation heat losses and heating costs respectively.
- o In the warm season the heat exchanger performs reverse and intake air is cooled in the heat exchanger by the cool extract air. That reduces operation load on air conditioners and saves electricity.

### Air filtration

- o Two built-in G4 and F7 filters provide efficient supply air filtration.
- o The G4 filter is used for extract air filtration.

### Air heater

- o The **KOMFORT EC LBE S21** units are equipped with an electric heater for additional heating of supply air downstream of the heat exchanger.
- o The **KOMFORT EC LB S21** units are not equipped with built-in heaters but both a preheater and a reheater can be purchased separately.

### Bypass

- o The **KOMFORT EC LB(E) S21** model is equipped with a bypass which is automatically opened in summer if there is a need to cool down the ventilated area with cool intake air.
- o If the unit is equipped with an electric heater, the bypass is used for freeze protection of the heat exchanger.

### Mounting

- o Mounting on floor or ceiling with fixing brackets.
- o The correctly mounted unit must provide condensate collecting and drainage as well as access to service mounting and filter replacement.

### Control and automation

- o **KOMFORT EC LB... S21** units are equipped with an integrated automation system. The remote control panel is not included in the delivery set (purchased separately).
- o The S21 controller allows to integrate the unit into the **Smart Home** system or **BMS (Building Management System)**.
- o The unit can be controlled via the **Blauberg AHU** mobile application via Wi-Fi.





Download the **Blauberg AHU** app for Android

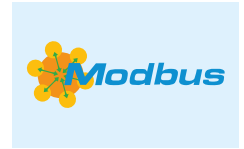

Download the **Blauberg AHU** app for iOS



## Automation functions

Functions	KOMFORT EC LB(E) S21
Unit control via Wi-Fi using a mobile application	+
Unit control via a wired remote control panel	S22 control panel (option) 
Unit control via a wireless remote control panel	S22 Wi-Fi control panel (option) 
Unit control via a wired remote LCD control panel	S25 control panel (option) 
BMS (Building Management System)	RS-485
	Wi-Fi
	Ethernet
	MODBUS (RTU, TCP)
Blauberg Cloud Server service	+
Speed selection	+
Filter replacement indication	by hour meter readings
Alarm indication	by filter clogging differential pressure switch
Week-scheduled operation	full alarm description in the mobile application
By-pass	+
Timer	automatic
Boost mode	manual
Fireplace mode	+
Freeze protection	through cyclic stops of the supply fan
	through preheating (option)
	using a bypass
Reheater connection	option
Cooler connection	option
Minimum supply air temperature control	+
Humidity control	option
CO <sub>2</sub> control	option
VOC control	option
PM2.5 control	option
Fire alarm sensor connection	option

Option: function is available when purchasing the appropriate accessory (see the "Accessories" section).

## Designation key

Series	Motor type	Spigot modification	Bypass	Heater type	Rated air flow, [m <sup>3</sup> /h]	Heat exchanger type	Control
KOMFORT	EC: electronically commutated motor	L: horizontal spigot orientation	B: with a bypass	_: without a heater E: electric heater	300; 400; 700	_: heat recovery -E: energy recovery	S21

## Overall dimensions [mm]

Model	∅ D	B	B1	H	L	L1
KOMFORT EC LB 300(-E) S21	157	566	480	479	1083	1180
KOMFORT EC LBE 300(-E) S21	157	566	480	479	1083	1180
KOMFORT EC LB 400(-E) S21	197	682	596	504	1094	1191
KOMFORT EC LBE 400(-E) S21	197	682	596	504	1094	1191
KOMFORT EC LB 700(-E) S21	247	866	700	601	1282	1379
KOMFORT EC LBE 700(-E) S21	247	866	700	601	1282	1379

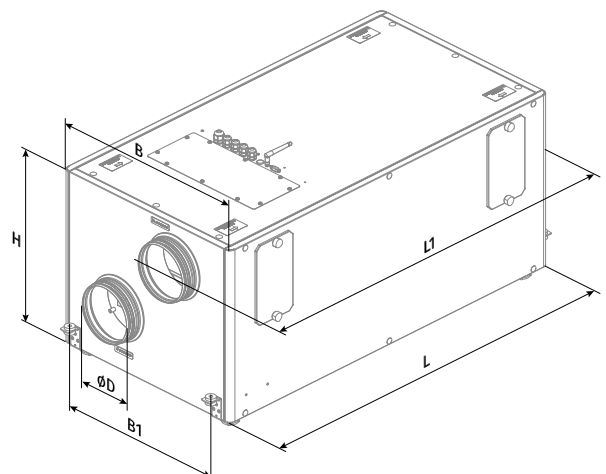

### Technical data

Parameters	KOMFORT EC LB 300 S21	KOMFORT EC LBE 300 S21	KOMFORT EC LB 300-E S21	KOMFORT EC LBE 300-E S21
Voltage [V / 50 (60) Hz]	1~ 230	1~ 230	1~ 230	1~ 230
Power (without a heater) [W]	182	182	182	182
Current (without a heater) [A]	1.4	1.4	1.4	1.4
Electric heater power [W]	-	2800	-	2800
Electric heater current [A]	-	12.2	-	12.2
Power (with a heater) [W]	182	2982	182	2982
Current (with a heater) [A]	1.4	13.6	1.4	13.6
Maximum air flow [m³/h (l/s)]	380 (106)	380 (106)	380 (106)	380 (106)
Sound pressure level at a distance of 3 m [dBA]	24	24	24	24
Transported air temperature [°C]	-25...+40	-25...+40	-25...+40	-25...+40
Casing material	galvanized steel	galvanized steel	galvanized steel	galvanized steel
Insulation	40 mm mineral wool	40 mm mineral wool	40 mm mineral wool	40 mm mineral wool
Extract filter	G4	G4	G4	G4
Supply filter	G4+F7	G4+F7	G4+F7	G4+F7
Connected air duct diameter [mm]	160	160	160	160
Weight [kg]	63.1	64.3	63.1	64.3
Heat recovery efficiency [%]	80–98	80–98	74–89	74–89
Heat exchanger type	counter-flow	counter-flow	counter-flow	counter-flow
Heat exchanger material	polystyrene	polystyrene	enthalpy	enthalpy
SEC class	A+	A+	A	A

Sound power level, A-weighted	Total	Octave band [Hz]								LpA 3 m	LpA 1 m
		63	125	250	500	1000	2000	4000	8000		
L <sub>WA</sub> to supply inlet [dBA]	67	50	55	56	62	60	62	56	50		
L <sub>WA</sub> to supply outlet [dBA]	53	42	47	46	46	44	39	29	21		
L <sub>WA</sub> to exhaust inlet [dBA]	68	56	54	61	62	59	61	56	50		
L <sub>WA</sub> to exhaust outlet [dBA]	55	42	47	51	48	46	43	31	22		
L <sub>WA</sub> to environment [dBA]	45	34	35	40	39	32	36	31	27	24	34

\*Data for point 1 in the performance diagram

Point	Power [W]	Sound pressure level at 3 m distance [dBA]
1	155	24 (34)
2	143	23 (33)
3	119	23 (33)
4	61	20 (30)
5	56	20 (30)
6	46	20 (30)
7	20	13 (23)
8	19	13 (23)
9	18	13 (23)

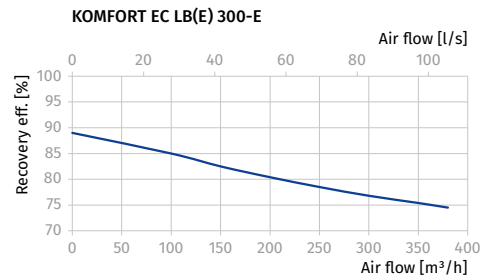
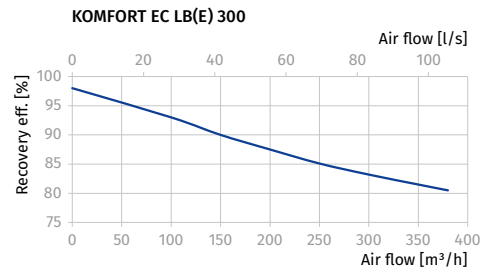
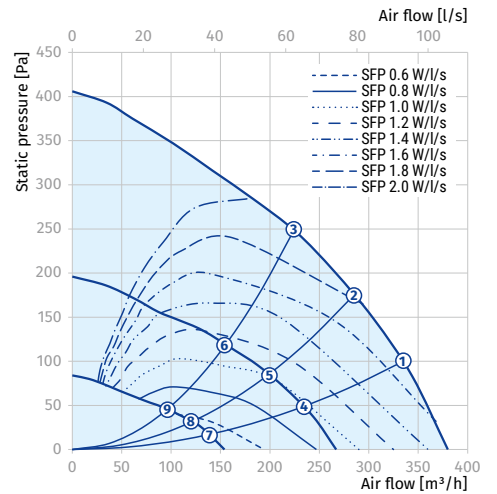

HEAT RECOVERY AIR HANDLING UNITS

Parameters	KOMFORT EC LB 400 S21	KOMFORT EC LBE 400 S21	KOMFORT EC LB 400-E S21	KOMFORT EC LBE 400-E S21
Voltage [V / 50 (60) Hz]	1~ 230	1~ 230	1~ 230	1~ 230
Power (without a heater) [W]	289	289	289	289
Current (without a heater) [A]	2.1	2.1	2.1	2.1
Electric heater power [W]	-	2800	-	2800
Electric heater current [A]	-	12.2	-	12.2
Power (with a heater) [W]	289	3089	289	3089
Current (with a heater) [A]	2.1	14.3	2.1	14.3
Maximum air flow [m <sup>3</sup> /h (l/s)]	540 (150)	540 (150)	540 (150)	540 (150)
Sound pressure level at a distance of 3 m [dBA]	27	27	27	27
Transported air temperature [°C]	-25...+40	-25...+40	-25...+40	-25...+40
Casing material	galvanized steel	galvanized steel	galvanized steel	galvanized steel
Insulation	40 mm mineral wool	40 mm mineral wool	40 mm mineral wool	40 mm mineral wool
Extract filter	G4	G4	G4	G4
Supply filter	G4+F7	G4+F7	G4+F7	G4+F7
Connected air duct diameter [mm]	200	200	200	200
Weight [kg]	74.8	76	74.8	76
Heat recovery efficiency [%]	84-98	84-98	78-89	78-89
Heat exchanger type	counter-flow	counter-flow	counter-flow	counter-flow
Heat exchanger material	polystyrene	polystyrene	enthalpy	enthalpy
SEC class	A+	A+	A	A

Sound power level, A-weighted	Total	Octave band [Hz]								LpA 3 m	LpA 1 m
		63	125	250	500	1000	2000	4000	8000		
L <sub>WA</sub> to supply inlet [dBA]	71	52	57	57	68	64	64	59	53		
L <sub>WA</sub> to supply outlet [dBA]	56	44	49	47	52	47	41	31	24		
L <sub>WA</sub> to exhaust inlet [dBA]	70	52	56	60	66	62	64	60	53		
L <sub>WA</sub> to exhaust outlet [dBA]	58	39	49	52	53	49	46	35	24		
L <sub>WA</sub> to environment [dBA]	48	32	37	40	45	36	38	35	30	27	37

\*Data for point 1 in the performance diagram

Point	Power [W]	Sound pressure level at 3 m distance [dBA]
1	240	27 (37)
2	215	26 (36)
3	196	26 (36)
4	89	21 (31)
5	80	21 (31)
6	72	20 (30)
7	27	19 (29)
8	26	19 (29)
9	24	17 (27)

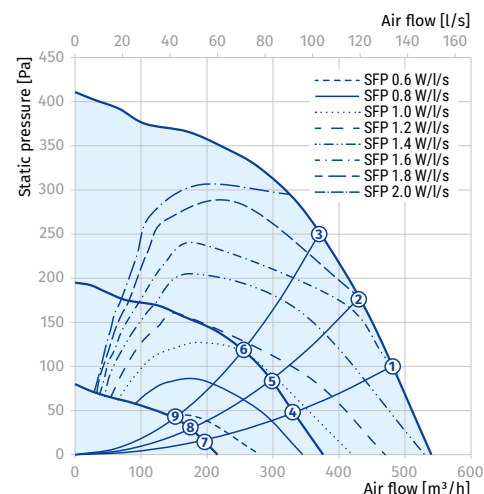

KOMFORT EC LB(E) 400

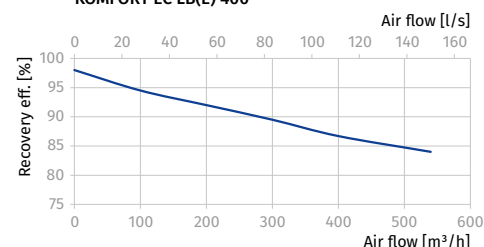

KOMFORT EC LB(E) 400-E

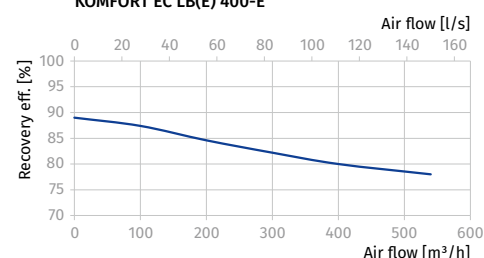

Parameters	KOMFORT EC LB 700 S21	KOMFORT EC LBE 700 S21	KOMFORT EC LB 700-E S21	KOMFORT EC LBE 700-E S21
Voltage [V / 50 (60) Hz]	1~ 230	1~ 230	1~ 230	1~ 230
Power (without a heater) [W]	336	336	336	336
Current (without a heater) [A]	2.4	2.4	2.4	2.4
Electric heater power [W]	-	3600	-	3600
Electric heater current [A]	-	15.6	-	15.6
Power (with a heater) [W]	336	3936	336	3936
Current (with a heater) [A]	2.4	18.0	2.4	18.0
Maximum air flow [m³/h (l/s)]	830 (231)	830 (231)	830 (231)	830 (231)
Sound pressure level at a distance of 3 m [dBA]	31	31	31	31
Transported air temperature [°C]	-25...+40	-25...+40	-25...+40	-25...+40
Casing material	galvanized steel	galvanized steel	galvanized steel	galvanized steel
Insulation	40 mm mineral wool	40 mm mineral wool	40 mm mineral wool	40 mm mineral wool
Extract filter	G4	G4	G4	G4
Supply filter	G4+F7	G4+F7	G4+F7	G4+F7
Connected air duct diameter [mm]	250	250	250	250
Weight [kg]	107	108.4	107	108.4
Heat recovery efficiency [%]	80–98	80–98	74–89	74–89
Heat exchanger type	counter-flow	counter-flow	counter-flow	counter-flow
Heat exchanger material	polystyrene	polystyrene	enthalpy	enthalpy
SEC class	A+	A+	A	A

Sound power level, A-weighted	Total	Octave band [Hz]								LpA 3 m	LpA 1 m
		63	125	250	500	1000	2000	4000	8000		
L <sub>WA</sub> to supply inlet [dBA]	76	56	61	61	73	69	69	64	57		
L <sub>WA</sub> to supply outlet [dBA]	60	49	53	52	56	51	44	34	26		
L <sub>WA</sub> to exhaust inlet [dBA]	74	56	60	65	70	66	68	64	56		
L <sub>WA</sub> to exhaust outlet [dBA]	61	42	53	56	56	52	49	37	25		
L <sub>WA</sub> to environment [dBA]	51	35	40	43	49	39	40	37	32	31	41





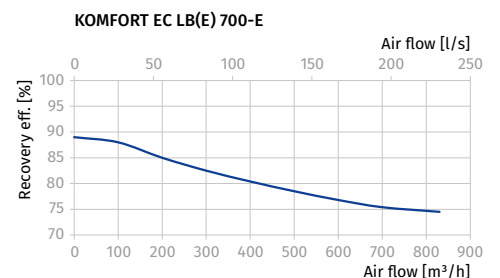
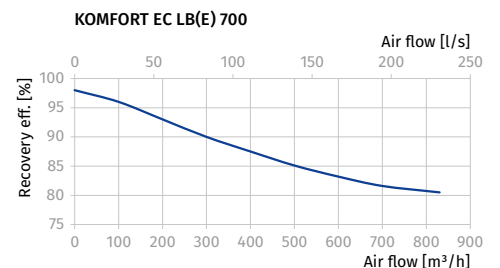
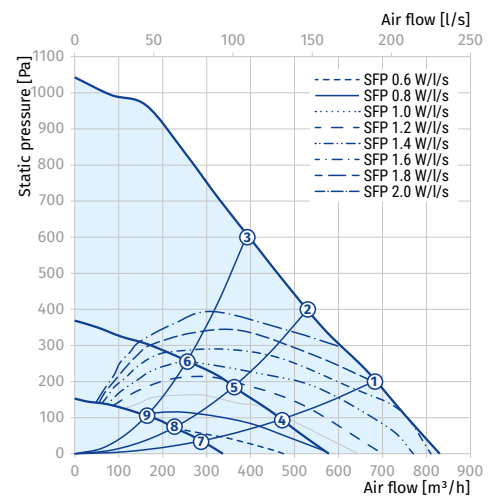











\*Data for point 1 in the performance diagram

Point	Power [W]	Sound pressure level at 3 m distance [dBA]
1	336	31 (41)
2	336	30 (40)
3	336	29 (39)
4	123	25 (35)
5	115	25 (35)
6	96	24 (34)
7	41	23 (33)
8	38	23 (33)
9	36	20 (30)



















HEAT RECOVERY AIR HANDLING UNITS

**Accessories**

		KOMFORT EC LB 300(-E) S21	KOMFORT EC LBE 300(-E) S21	KOMFORT EC LB 400(-E) S21
Panel filter G4		FP 484x178x48 G4	FP 484x178x48 G4	FP 600x205x48 G4
Panel filter F7		FP 484x178x48 F7	FP 484x178x48 F7	FP 600x205x48 F7
Control panel		S22	S22	S22
Wireless control panel		S22 Wi-Fi	S22 Wi-Fi	S22 Wi-Fi
LCD control panel		S25	S25	S25
Indoor humidity sensor		FS2	FS2	FS2
CO <sub>2</sub> sensor with indication		CD-1	CD-1	CD-1
CO <sub>2</sub> sensor		CD-2	CD-2	CD-2
Humidity sensor		HR-S	HR-S	HR-S
Reheater		ENH 160 S21 V.2	-	ENH 200 S21 V.2
Preheater		EVH 160 S21 V.2	EVH 160 S21 V.2	EVH 200 S21 V.2
Silencer		SD 160	SD 160	SD 200
Non-return valve		VRV 160	VRV 160	VRV 200
Air damper		VKA 160	VKA 160	VKA 200
Drain pump		CP-2	CP-2	CP-2
Air damper actuator		TF230	TF230	TF230



		KOMFORT EC LBE 400(-E) S21	KOMFORT EC LB 700(-E) S21	KOMFORT EC LBE 700(-E) S21
Panel filter G4		FP 600x205x48 G4	FP 784x253x48 G4	FP 784x253x48 G4
Panel filter F7		FP 600x205x48 F7	FP 784x253x48 F7	FP 784x253x48 F7
Control panel		S22	S22	S22
Wireless control panel		S22 Wi-Fi	S22 Wi-Fi	S22 Wi-Fi
LCD control panel		S25	S25	S25
Indoor humidity sensor		FS2	FS2	FS2
CO <sub>2</sub> sensor with indication		CD-1	CD-1	CD-1
CO <sub>2</sub> sensor		CD-2	CD-2	CD-2
Humidity sensor		HR-S	HR-S	HR-S
Reheater		-	ENH 250 S21 V.2	-
Preheater		EVH 200 S21 V.2	EVH 250 S21 V.2	EVH 250 S21 V.2
Silencer		SD 200	SD 250	SD 250
Non-return valve		VRV 200	VRV 250	VRV 250
Air damper		VKA 200	VKA 250	VKA 250
Drain pump		CP-2	CP-2	CP-2
Air damper actuator		TF230	TF230	TF230

# KOMFORT RoTo EC SKE 200

Air handling units with rotary heat exchanger



## Features

- Air handling units for efficient supply and exhaust ventilation in flats, houses, cottages and other buildings.
- Heat recovery is provided by the rotary heat exchanger and minimizes ventilation heat losses
- Controllable air exchange for creating the best suitable indoor microclimate.
- Unit is equipped with kitchen hood.



**Air flow:**  
up to 270 m<sup>3</sup>/h  
75 l/s



**Heat recovery efficiency:**  
up to 94 %



## Design

- The fan casing is made of galvanized steel, internally filled with mineral wool layer for heat and sound insulation.
- The insulation is 25 mm thick.
- KOMFORT Roto EC SK 200 – unit w/o electric heater.
- KOMFORT Roto EC SKE 200 – unit with an electric heater.

## Air filtration

- Two built-in **Coarse 90% (G4)** filters provide efficient supply air filtration.
- Supply ePM1 65% (F7) filter available as an option.

## Heater

- Units **KOMFORT Roto EC SKE 200** are equipped with an electric heater.

## Decorative panel

- **Blauberg EP-Roto EC SKE 200 Hi-tech** – stainless steel decorative panels for improving appearance of the products.



**KOMFORT ROTO EC SK 200 L**

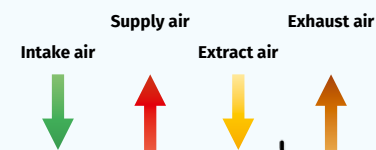

**KOMFORT ROTO EC SK 200 R**

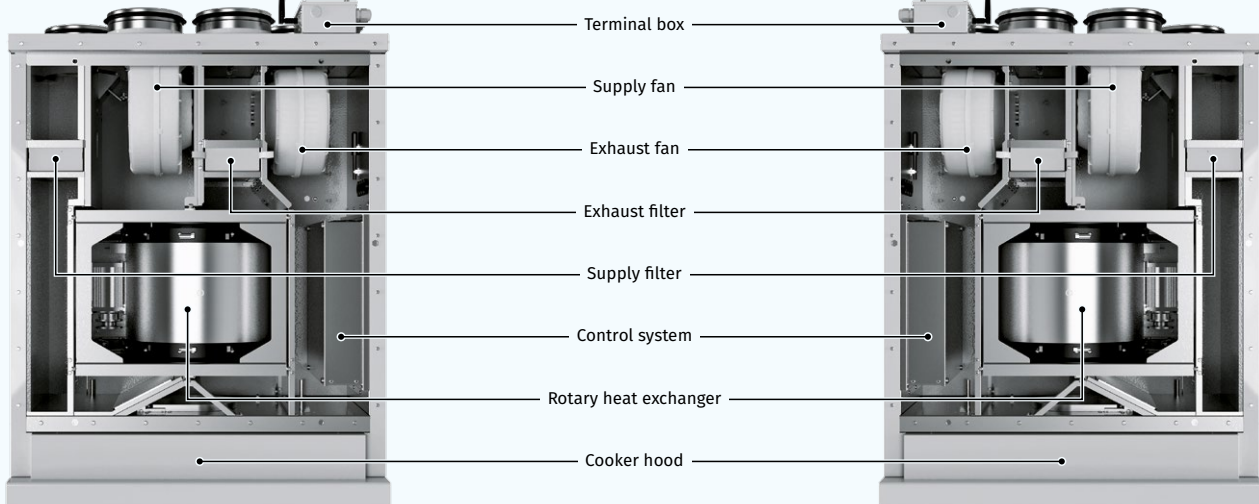
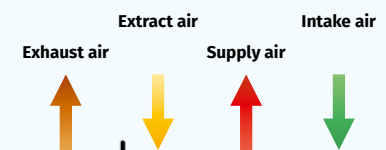

AIR HANDLING UNITS WITH ROTARY HEAT EXCHANGER

### Heat recovery

- o The unit has a high-efficient rotary heat exchanger.
- o The advantages of the rotary heat exchanger as compared to plate heat exchangers include no condensate generation, maintaining comfort air humidity and high freeze resistance.

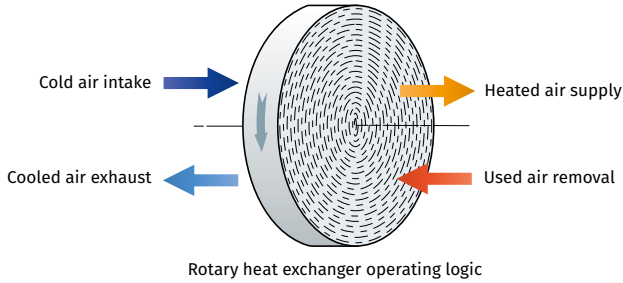

### Control and automation

- o The units are equipped with an integrated automation system. The remote control panel is not included in the delivery set (purchased separately).
- o The S21 controller allows to integrate the unit into the **Smart Home** system or **BMS (Building Management System)**.
- o Unit control is done via Wi-Fi using the mobile application **Blauberg Home**.





Download the Blaubeerg Home app for Android



Download the Blaubeerg Home app for iOS



### Automation functions

Functions	Description
Unit control via Wi-Fi using a mobile application	+
Unit control via a wired remote control panel	S22 control panel (option) 
Unit control via a wireless remote control panel	S22 Wi-Fi control panel (option) 
Unit control via a wired remote LCD control panel	S25 control panel (option) 
<b>BMS (Building Management System)</b>	RS-485
	Wi-Fi
	Ethernet
	MODBUS (RTU, TCP)
<b>Blauberg Cloud Server service</b>	+
<b>Speed selection</b>	+
<b>Filter replacement indication</b>	by filter timer
<b>Alarm indication</b>	+
<b>Week-scheduled operation</b>	+
<b>Bypass</b>	automatic
	manual
<b>Timer</b>	+
<b>Boost mode</b>	+
<b>Fireplace mode</b>	+
<b>Freeze protection</b>	+
<b>Cooler connection</b>	+
<b>Minimum supply air temperature control</b>	+
<b>Humidity control</b>	option
<b>CO<sub>2</sub> control</b>	option
<b>VOC control</b>	option
<b>PM2.5 control</b>	option
<b>Fire alarm sensor connection</b>	option

Option: the function is available when purchasing the appropriate accessory (see the "Accessories" section).

### Designation key

Series	Motor	Casing type	Modification	Size	Unit version	Control system
KOMFORT Roto	EC: electronically commutated motor	S: vertical	K: integrated white hood E: integrated electric heater S: integrated stainless steel hood	200: nominal airflow [m <sup>3</sup> /h]	L: left version R: right version	S21

**Overall dimensions [mm]**

Model	H	L	L1	W	W1	W2
KOMFORT Roto EC SK(E) 200	746	326	338	596	408	173

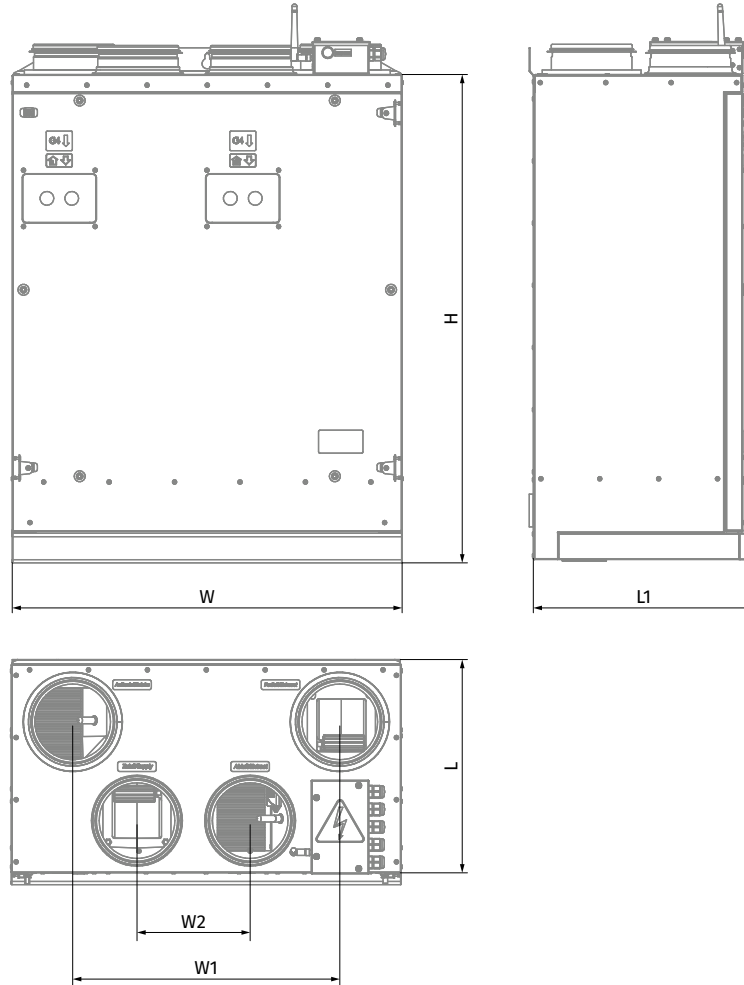







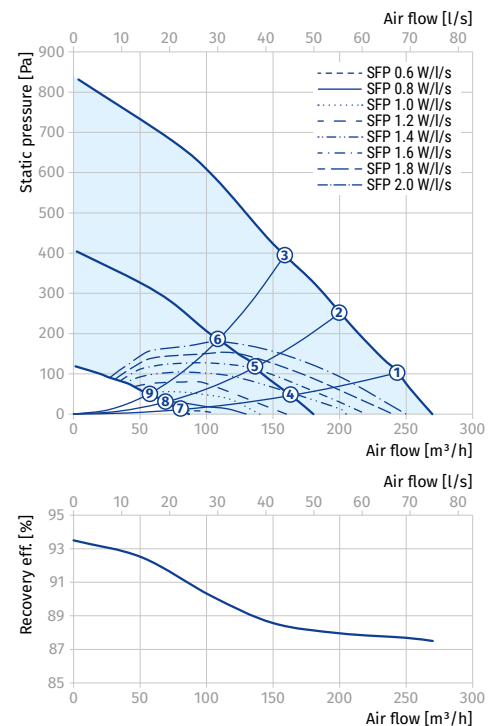



AIR HANDLING UNITS WITH ROTARY HEAT EXCHANGER

**Technical data**

Parameters	KOMFORT Roto EC SK 200	KOMFORT Roto EC SKE 200
Voltage [V / 50-60 Hz]	1 ~ 230	1 ~ 230
Max. unit power without electric heater [W]	171	171
Max. power of electric heater [W]	-	700
Max. unit power [W]	171	871
Max. unit current without electric heater [A]	1.31	1.31
Max. unit current of electric heater [A]	-	3.0
Max. unit current [A]	1.31	4.31
Max. air flow [m³/h]	270	270
Sound pressure level at 3 m distance [dBA]	33	33
Operating temperature [°C]	-25...+40	-25...+40
Case material	polymer coated steel	polymer coated steel
Insulation	25 mm, mineral wool	25 mm, mineral wool
Extract filter	G4	G4
Supply filter	G4 (F7 optional)	G4 (F7 optional)
Connected air duct diameter [mm]	125	125
Weight [kg]	52	53
Heat recovery efficiency [%]	87-93	87-93
Heat exchanger type	rotary	rotary
Heat exchanger material	aluminum	aluminum
SEC class	A	A



## Accessories

		KOMFORT Roto EC SK 200 S21	KOMFORT Roto EC SKE 200 S21
Decorative panel		EP-Roto EC SKE 200 Hi-tech	EP-Roto EC SKE 200 Hi-tech
G4 panel filter		FP 261x86x48 Coarse 90% G4	FP 261x86x48 Coarse 90% G4
F7 panel filter		FP 261x86x48 ePM1 65% F7	FP 261x86x48 ePM1 65% F7
LCD control panel		S25	S25
Control panel		S22	S22
Wireless control panel		S22 Wi-Fi	S22 Wi-Fi
CO <sub>2</sub> sensor with indication		CD-1	CD-1
Humidity sensor		HR-S	HR-S
Silencer		SD 125	SD 125
Air damper		VKA 125	VKA 125
Electric actuator		TF230	TF230

# KOMFORT RoTo EC SE

## Heat recovery air handling units

### Features

- Air handling units for efficient supply and exhaust ventilation in flats, houses, cottages and other buildings.
- Heat recovery is provided by the rotary heat exchanger and minimizes ventilation heat losses.
- Controllable air exchange for creating the best suitable indoor microclimate.
- Compatible with round Ø 125, 160 and 200 mm air ducts.
- Additional spigot for kitchen hood air duct connection.



**Air flow:**  
up to 670 m<sup>3</sup>/h  
186 l/s



**Heat recovery efficiency:**  
up to 92 %



### Design

- The fan casing is made of galvanized steel, internally filled with mineral wool layer for heat and sound insulation.
- The spigots are located at the top of the unit and are rubber sealed for airtight connection to the air ducts.
- The insulation of **KOMFORT Roto EC SE 280, 400 and 600** is 40 mm.
- **KOMFORT Roto EC S(2)E**: model with electric heater.

### Fans

- High-efficient external rotor EC motors and centrifugal impellers with forward curved blades are used for air supply and exhaust.

- EC motors have the best power consumption to air flow ratio and meet the latest demands concerning energy saving and high-efficient ventilation.
- EC motors are featured with high performance, low noise level and totally controllable speed range.
- Dynamically balanced impellers.

### Kitchen hood

- All units are equipped with a 5th spigot for connection to the kitchen hood air duct.

AIR HANDLING UNITS WITH ROTARY HEAT EXCHANGER

**KOMFORT ROTO EC S2E 280**

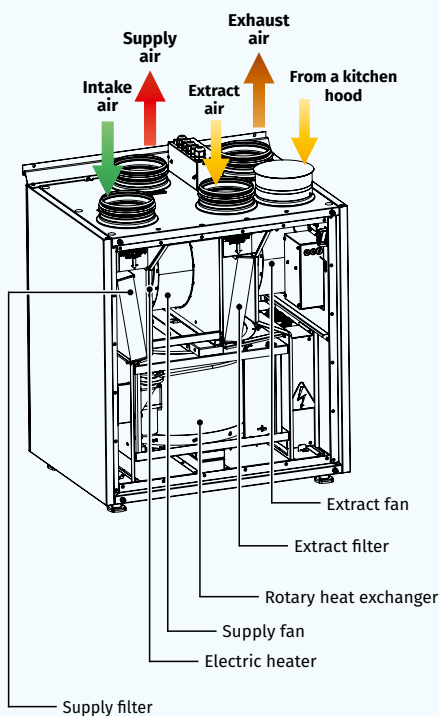

**KOMFORT ROTO EC SE 400  
KOMFORT ROTO EC SE 600**

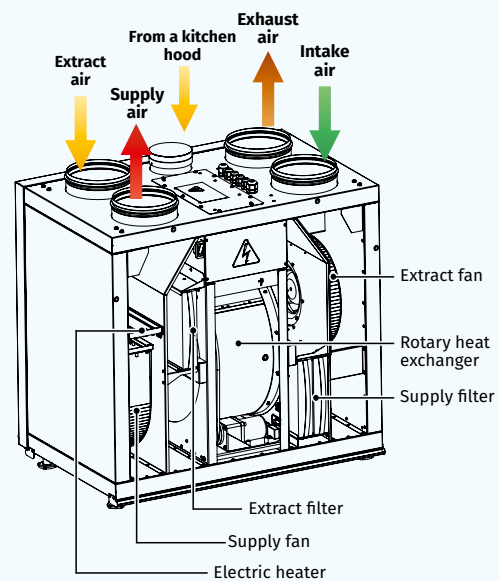

### Air filtration

- Two built-in G4 and F7 filters provide efficient supply air filtration. The unit **KOMFORT Roto EC S2E 280** features F7 filter.
- The G4 filter is used for extract air filtration.

### Heat recovery

- The unit has a high-efficient rotary heat exchanger.
- The rotary regenerator is a short, rotating cylinder, filled with corrugated aluminium sheet layers. The air streams flow through them.
- The band layers of the heat regenerator first come in contact with the supply and then with extract air flows.
- Therefore the band is alternatively warmed up and cooled down and the extract air heat and humidity are transferred to the cold intake air. This way heat recovery reduces heat losses in the cold season and reduces operation load for air conditioner in the warm season.
- The advantages of the rotary regenerator as compared to the plate heat exchangers include no condensate generation, maintaining comfort air humidity and high freeze resistance.

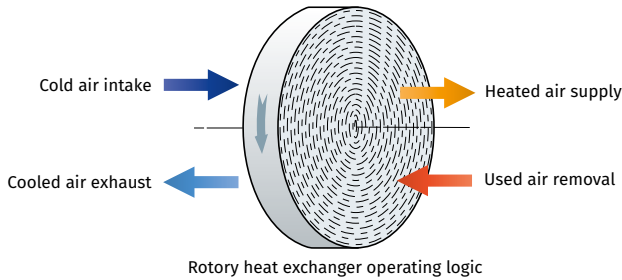

### Heater

- The **KOMFORT Roto EC SE** units are equipped with the electric heater. If the necessary temperature level of the supply air cannot be achieved through heat recovery, the heater turns on automatically and heats the air supplied to the premise. The heaters incorporate protective measures securing the safe unit operation.

### Mounting

- The units can be fixed to the wall or mounted on the floor.
- During mounting stage the front and the back panels can be reversed providing either left-handed or right-handed unit mounting.

### Control and automation

- KOMFORT Roto EC S... S21** units are equipped with an integrated automation system. The remote control panel is not included in the delivery set (purchased separately).
- The S21 controller allows to integrate the unit into the **Smart Home** system or **BMS (Building Management System)**.
- The unit can be controlled via the **Blauberg AHU** mobile application via Wi-Fi.



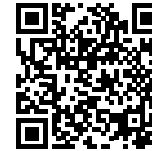

Download the **Blauberg AHU** app for Android



Download the **Blauberg AHU** app for iOS



### Automation functions

Functions	Description
Control via Wi-Fi using a mobile application	+
Control via a wired remote control panel	S22 control panel (option) 
Control via a wireless remote control panel	S22 Wi-Fi control panel (option) 
Control via a wired remote LCD control panel	S25 control panel (option) 
BMS (Building Management System)	RS-485
	Wi-Fi
	Ethernet
	MODBUS (RTU, TCP)
Blauberg Cloud Server service	+
Speed selection	+
Filter replacement indication	by filter timer
Alarm indication	full alarm description in the mobile application
Week-scheduled operation	+
Timer	+
Boost mode	+
Fireplace mode	+
Cooler connection	option
Kitchen hood connection	option
Minimum supply air temperature control	+
Humidity control	option
CO <sub>2</sub> control	option
VOC control	option
PM2.5 control	option
Fire alarm sensor connection	option

Option: function is available when purchasing the appropriate accessory (see the "Accessories" section).

### Designation key

Series	Unit type	Motor type	Spigot modification	Insulation	Heater type	Rated air flow [m³/h]	Control
KOMFORT	Roto: rotary heat exchanger	EC: electronically commutated motor	S: vertical spigot orientation	_: 40 mm	E: electric heater	280; 400; 600	S21

### Overall dimensions [mm]

Model	Ø D	Ø D1	B	B1	H	H1	H2	L	L1
KOMFORT Roto EC SE 280 S21	125	125	482	-	630	754	-	598	-
KOMFORT Roto EC SE 400 S21	160	100	528	-	675	755	-	747	-
KOMFORT Roto EC SE 600 S21	200	125	628	-	772	852	-	819	-

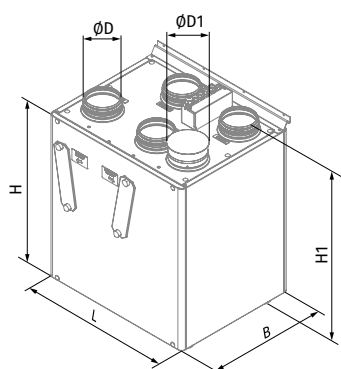

KOMFORT Roto EC SE 280

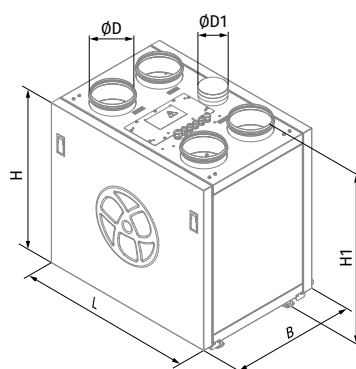

KOMFORT Roto EC SE 400  
KOMFORT Roto EC SE 600



### Technical data

Parameters	KOMFORT Roto EC SE 280 S21
Voltage [V / 50 (60) Hz]	1~230
Max. unit power without electric heater [W]	195
Max. power of electric heater [W]	650
Max. unit power [W]	845
Max. unit current without electric heater [A]	1.9
Max. unit current of electric heater [A]	2.8
Max. unit current [A]	4.7
Maximum air flow [m³/h (l/s)]	300 (83)
Sound pressure level at 3 m distance [dBA]	26
Operating temperature [°C]	-25...+40
Casing material	polymer coated steel
Insulation	40 mm mineral wool
Extract filter	G4
Supply filter	F7
Connected air duct diameter [mm]	125
Weight [kg]	64
Heat recovery efficiency [%] *	81-90
Heat exchanger type	rotary
Heat exchanger material	aluminum
SEC class	A
ErP	2016, 2018

\*Heat recovery efficiency is specified in compliance with EN 13141-7.

### KOMFORT ROTO EC SE 280

Sound power level, A-weighted	Total	Octave frequency band [Hz]								LpA 3 m	LpA 1 m
		63	125	250	500	1000	2000	4000	8000		
LWA to supply inlet [dBA]	54	47	42	50	44	41	39	39	31		
LWA to supply outlet [dBA]	69	63	56	65	59	55	50	52	46		
LWA to exhaust inlet [dBA]	54	47	41	51	43	33	31	34	30		
LWA to exhaust outlet [dBA]	65	61	50	61	55	46	43	46	40		
LWA to environment [dBA]	47	42	37	43	36	31	28	26	21	26	36

Data provided for point 1 of the air flow diagram

Total power. Total sound pressure level.

Point	Total power of the unit [W]	Sound pressure level at 3 m (1 m) [dBA]
1	154	26 (36)
2	132	26 (36)
3	110	25 (35)
4	55	24 (34)
5	47	24 (34)
6	38	22 (32)
7	19	15 (25)
8	18	14 (24)
9	17	13 (23)

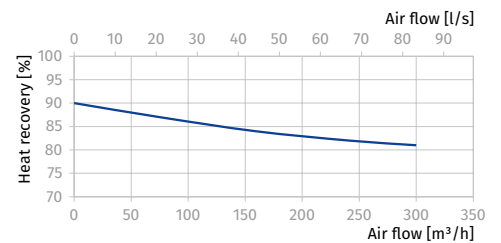
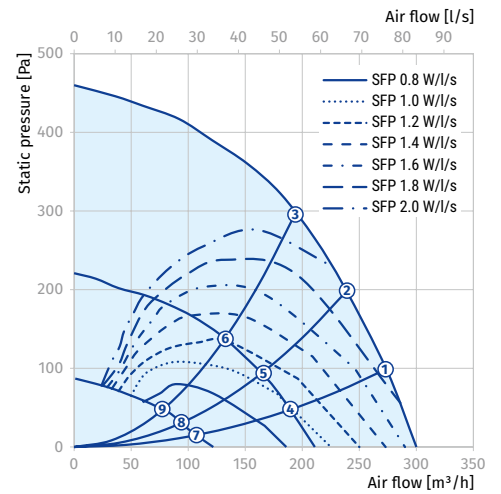

### Calculation of air temperature downstream of the heat exchanger:

$$t = t_{\text{outd}} + k_{\text{hr}} \times (t_{\text{extr}} - t_{\text{outd}}) / 100,$$

where

$t_{\text{outd}}$  – outdoor air temperature [°C]

$t_{\text{extr}}$  – extract air temperature [°C]

$k_{\text{hr}}$  – heat exchanger efficiency (according to the diagram) [%]

Parameters	KOMFORT Roto EC SE 400 S21
Voltage [V / 50 (60) Hz]	1~230
Max. unit power without electric heater [W]	200
Max. power of electric heater [W]	1400
Max. unit power [W]	1600
Max. unit current without electric heater [A]	1.4
Max. unit current of electric heater [A]	6.1
Max. unit current [A]	7.5
Maximum air flow [m <sup>3</sup> /h (l/s)]	440 (122)
Sound pressure level at 3 m distance [dBA]	33
Operating temperature [°C]	-25...+40
Casing material	polymer coated steel
Insulation	40 mm mineral wool
Extract filter	G4
Supply filter	G4+F7
Connected air duct diameter [mm]	160
Weight [kg]	82
Heat recovery efficiency [%] *	76-85
Heat exchanger type	rotary
Heat exchanger material	aluminum
SEC class	A
ErP	2016, 2018

\*Heat recovery efficiency is specified in compliance with EN 13141-7.

**KOMFORT ROTO EC SE 400**

Sound power level, A-weighted	Total	Octave frequency band [Hz]								LpA 3 m	LpA 1 m
		63	125	250	500	1000	2000	4000	8000		
L <sub>WA</sub> to supply inlet [dBA]	59	27	46	54	55	53	48	44	35		
L <sub>WA</sub> to supply outlet [dBA]	60	27	46	54	55	53	49	44	35		
L <sub>WA</sub> to exhaust inlet [dBA]	55	25	41	50	51	44	42	39	30		
L <sub>WA</sub> to exhaust outlet [dBA]	55	26	41	51	51	44	42	39	31		
L <sub>WA</sub> to environment [dBA]	54	18	36	47	49	48	43	37	33	33	43

Data provided for point 1 of the air flow diagram

**Total power. Total sound pressure level.**

Point	Total power of the unit [W]	Sound pressure level at 3 m (1 m) [dBA]
1	170	33 (43)
2	170	33 (43)
3	170	32 (42)
4	68	31 (41)
5	65	28 (38)
6	59	27 (37)
7	26	23 (33)
8	25	21 (31)
9	25	19 (29)

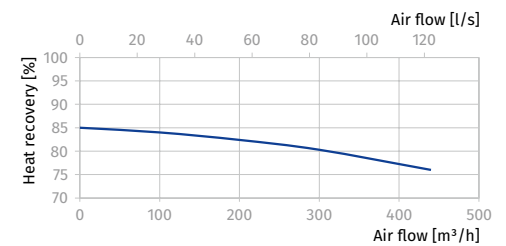
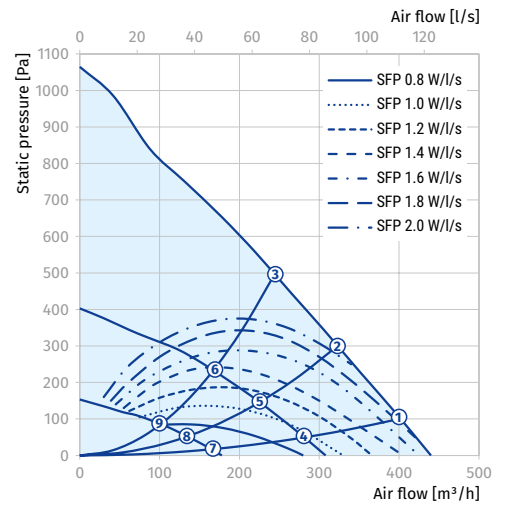

AIR HANDLING UNITS WITH ROTARY HEAT EXCHANGER

Parameters	KOMFORT Roto EC SE 600 S21
Voltage [V / 50 (60) Hz]	1~230
Max. unit power without electric heater [W]	405
Max. power of electric heater [W]	2800
Max. unit power [W]	3205
Max. unit current without electric heater [A]	2.6
Max. unit current of electric heater [A]	12.2
Max. unit current [A]	14.8
Maximum air flow [m³/h (l/s)]	670 (186)
Sound pressure level at 3 m distance [dBA]	35
Operating temperature [°C]	-25...+40
Casing material	polymer coated steel
Insulation	40 mm mineral wool
Extract filter	G4
Supply filter	G4+F7
Connected air duct diameter [mm]	200
Weight [kg]	92
Heat recovery efficiency [%] *	81-89
Heat exchanger type	rotary
Heat exchanger material	aluminum
SEC class	A
ErP	2016, 2018

\*Heat recovery efficiency is specified in compliance with EN 13141-7.

**KOMFORT ROTO EC SE 600**

Sound power level, A-weighted	Total	Octave frequency band [Hz]								LpA 3 m	LpA 1 m
		63	125	250	500	1000	2000	4000	8000		
LWA to supply inlet [dBA]	82	65	63	65	80	74	74	68	64		
LWA to supply outlet [dBA]	66	60	56	55	63	58	49	40	33		
LWA to exhaust inlet [dBA]	82	64	67	71	81	77	79	75	67		
LWA to exhaust outlet [dBA]	70	51	64	62	68	60	60	50	42		
LWA to environment [dBA]	56	39	47	46	54	46	46	44	40	35	45

Data provided for point 1 of the air flow diagram





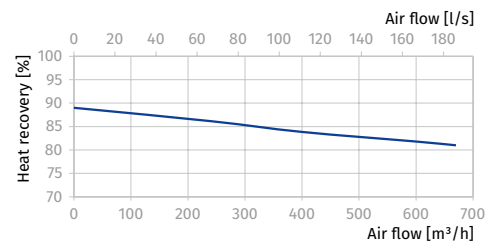
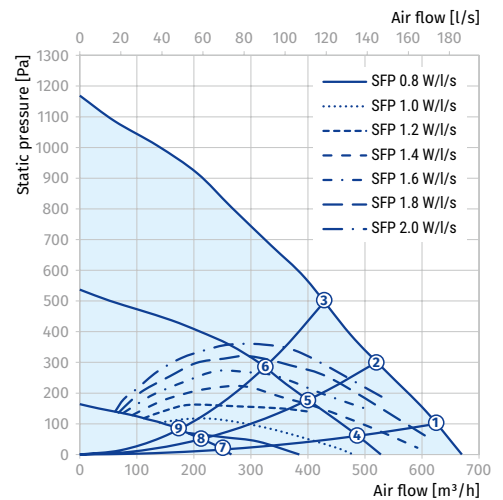







Total power. Total sound pressure level.













Point	Total power of the unit [W]	Sound pressure level at 3 m (1 m) [dBA]
1	375	35 (45)
2	375	35 (45)
3	375	34 (44)
4	163	30 (40)
5	155	29 (39)
6	151	28 (38)
7	43	27 (37)
8	42	23 (33)
9	39	23 (33)



AIR HANDLING UNITS WITH ROTARY HEAT EXCHANGER

**Accessories**

		KOMFORT Roto EC SE 280 S21	KOMFORT Roto EC SE 400 S21
G4 panel filter		FP 400x196x40 G4	FP 436x196x40 G4
F7 panel filter		FP 400x196x40 F7	FP 436x196x40 F7
Control panel		S22	S22
Wireless control panel		S22 Wi-Fi	S22 Wi-Fi
LCD control panel		S25	S25
CO <sub>2</sub> sensor with indication		CD-1	CD-1
CO <sub>2</sub> sensor		CD-2	CD-2
Humidity sensor		HR-S	HR-S
Humidity sensor		FS2	FS2
Silencer		SD 125	SD 160
Backdraft air damper		VRV 125	VRV 160
Air damper		VKA 125	VKA 160
Electric actuator		TF230	TF230

KOMFORT Roto EC SE 600 S21		
G4 panel filter		FP 536x220x40 G4
F7 panel filter		FP 536x220x40 F7
Control panel		S22
Wireless control panel		S22 Wi-Fi
LCD control panel		S25
CO <sub>2</sub> sensor with indication		CD-1
CO <sub>2</sub> sensor		CD-2
Humidity sensor		HR-S
Humidity sensor		FS2
Silencer		SD 200
Backdraft air damper		VRV 200
Air damper		VKA 200
Electric actuator		TF230

# KOMFORT Roto EC LE/LW

Air handling units with rotary heat exchanger

## Features

- Air handling units for efficient supply and exhaust ventilation in flats, houses, cottages and other buildings.
- Used to create controlled energy-saving ventilation systems.
- The heat recovery technology is used to minimize ventilation heat losses.
- Control of air exchange for creating comfortable indoor microclimate.
- Compatible with round  $\varnothing$  160, 250 or 315 mm air ducts. **KOMFORT Roto EC LE/LW 2000** are designed for connection to 500x300 mm rectangular air ducts.



**Air flow:**  
up to 2250 m<sup>3</sup>/h  
625 l/s



**Heat recovery efficiency:**  
up to 95 %



## Design

- **KOMFORT Roto EC LE** – model with electric heater.
- **KOMFORT Roto EC LW** – model with water heater.
- The casing is made of double-skinned aluzinc panels, internally filled with 20–25 mm mineral wool layer for heat- and sound-insulation.
- The casing has mounting brackets with anti-vibration rubber mounts for easy installation.
- The spigots are located at the sides of the unit and are equipped with rubber seals for airtight connection to the air ducts.
- The hinged side panels ensure easy access to the internals for service works including cleaning, filter replacement, etc.

## Air filtration

- The built-in G4 supply filter and G4 extract filter provide air filtration.

## Fans

- The unit is equipped with high-efficient external rotor EC motors and centrifugal impellers with backward curved blades.
- EC motors have the best power consumption to air flow ratio and meet the latest demands concerning energy saving and high-efficient ventilation.
- EC motors are featured with high performance, low noise level and totally controllable speed range.
- The impellers are dynamically balanced.

## Mounting

- The unit can be installed on the floor, suspended to the ceiling or fixed to the wall by means of mounting brackets.
- The correctly mounted unit must provide condensate collecting and drainage and free access to the hinged side panel for servicing and filter replacement.
- Access on the left side.

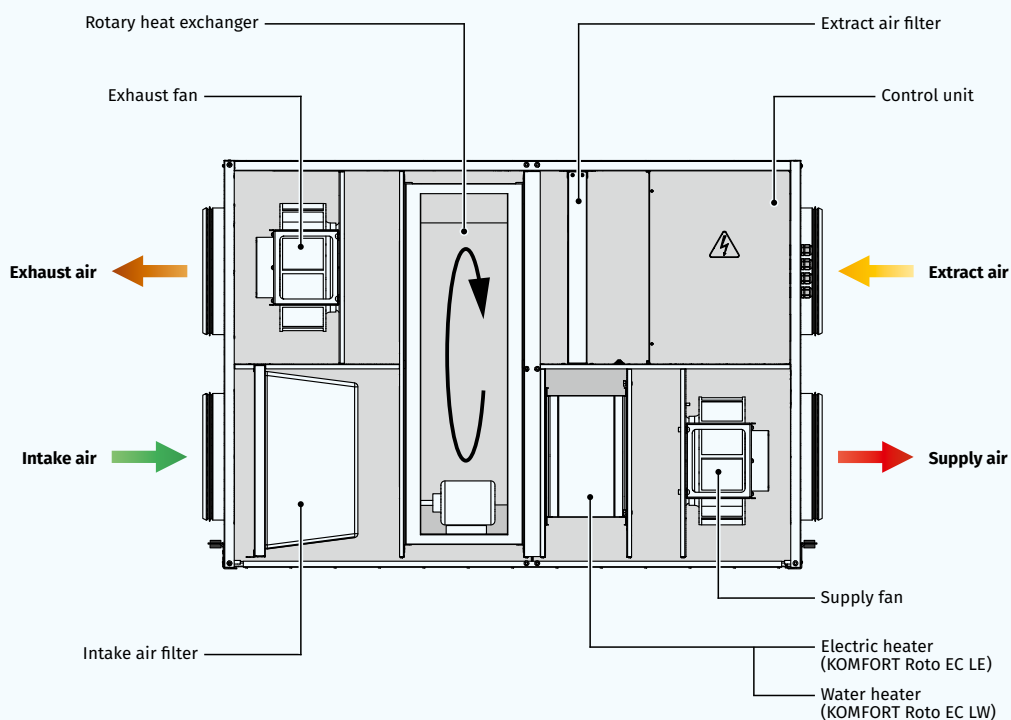

### Heat recovery

- The unit has a high-efficient rotary aluminium heat exchanger.
- The rotary regenerator is a short, rotating cylinder, filled with corrugated aluminium sheet layers. The air streams flow through them.
- The band layers of the heat regenerator first come in contact with the supply and then with extract air flows.
- Therefore the band is alternatively warmed up and cooled down and the extract air heat and humidity are transferred to the cold intake air. This way heat recovery reduces heat losses in the cold season and reduces operation load for air conditioner in the warm season.
- The advantages of the rotary regenerator as compared to the plate heat exchangers include no condensate generation, maintaining comfort air humidity and high freeze resistance.

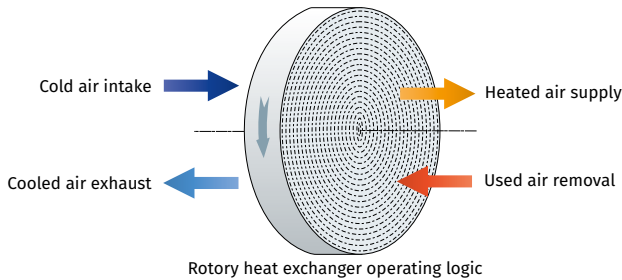

- For overheating protection the electro heater is equipped with two built-in thermal switches: with +60 °C operating temperature, automatic restart, and with +90 °C operating temperature, manual restart.
- **KOMFORT Roto EC LW** are equipped with a water (glycol) heater for operation at low outside temperatures.
- Smooth water heater control ensures automatic maintenance of supply air temperature.
- The air temperature sensor downstream of the heater and the return water temperature sensor are used for freezing protection of the water heater.
- Water heaters are designed for operation with maximum operating pressure of 1 MPa (10 bar) and maximum heat medium operating temperature +95 °C.
- The spigots of water heater are located on service panel side.

### Control and automation

- **KOMFORT Roto EC LE S17** and **KOMFORT Roto EC LW S17** are equipped with the th-Tune control panel.
- **KOMFORT Roto EC LE S18** and **KOMFORT Roto EC LW S18** are equipped with the pGD1 control panel.
- **Automation functions:**
  - Fan speed selection: low, high or medium.
  - Speed setting from 0 to 100 % for supply and exhaust fans separately
  - Filter maintenance indication
  - Alarm indication
  - Timer-based operation of the unit
  - Week-scheduled operation of the unit
  - Control and regulation of supply air temperature
  - CCU controlling
  - Air damper actuator controlling



### Heater

- The integrated heater is activated to warm up supply air flow if set indoor air temperature may not be reached by means of heat recovery only.
- **KOMFORT Roto EC LE** are equipped with an electric heater for operation at low outside temperatures.
  - Smooth electric heater output control ensures automatic maintenance of supply air temperature.

### Designation key

Series	Unit type	Motor type	Spigot modification	Heater type	Rated air flow [m³/h]	Heater parameters	Control
KOMFORT	<b>Roto:</b> rotary heat exchanger	<b>EC:</b> electronically commutated motor	<b>L:</b> horizontal spigot orientation	<b>E:</b> electric heater <b>W:</b> water heater	<b>400; 700; 900; 1200; - 1500; 2000</b>	<b>2; 3.3; ...:</b> heater power [kW] (electric heater) <b>2:</b> heater rows (water heater)	<b>S17:</b> thTune control panel <b>S18:</b> pGD1 control panel

### Overall dimensions [mm]

Model	D	B	B1	H	L	X	Y
KOMFORT Roto EC LE/LW 400	159	648	440	670	1050	-	-
KOMFORT Roto EC LE/LW 700	249	745	580	700	1210	-	-
KOMFORT Roto EC LE/LW 1000	249	745	580	700	1210	-	-
KOMFORT Roto EC LE/LW 1200	314	745	460	880	1335	-	-
KOMFORT Roto EC LE/LW 1500	314	855	560	1010	1430	-	-
KOMFORT Roto EC LE/LW 2000	-	875	630	1010	1485	500	300

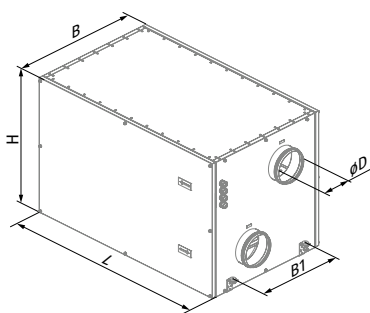

KOMFORT Roto EC LE/LW 400 / Roto EC LE/LW 700 / Roto EC LE/LW 1000

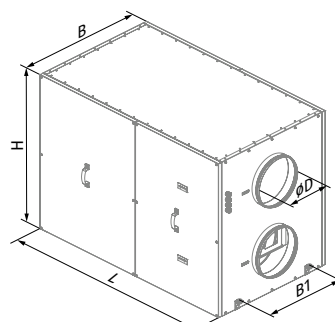

KOMFORT Roto EC LE/LW 1200 / Roto EC LE/LW 1500

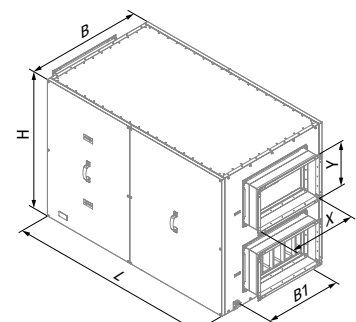

KOMFORT Roto EC LE/LW 2000

**Technical data**

Parameters	KOMFORT Roto EC LE 400-2 S17/S18	KOMFORT Roto EC LE 700-3.3 S17/S18	KOMFORT Roto EC LE 1000-4.5 S17/S18	KOMFORT Roto EC LE 1200-6 S17/S18	KOMFORT Roto EC LE 1500-9 S17/S18	KOMFORT Roto EC LE 2000-12 S17/S18
Voltage [V / 50 (60) Hz]	1 ~ 230	1 ~ 230	3 ~ 400	3 ~ 400	3 ~ 400	3 ~ 400
Motor max. power [W]	2 items x 100	2 items x 105	2 items x 135	2 items x 208	2 items x 222	2 items x 448
Electric heater power [W]	2000	3300	4500	6000	9000	12000
Max. power with electric heater [W]	2290	3615	4940	6570	9750	13070
Max. current with electric heater [A]	9.9	15.8	7.2	9.5	14.1	22.4
Maximum air flow [m³/h (l/s)]	400 (111)	700 (194)	900 (250)	1200 (333)	1500 (417)	2250 (625)
Sound pressure level at 3 m [dBA]	45	52	58	60	62	64
Transported air temperature [°C]	-25...+40	-25...+40	-25...+40	-25...+40	-25...+40	-25...+40
Casing material	aluzinc	aluzinc	aluzinc	aluzinc	aluzinc	aluzinc
Insulation	20 mm mineral wool	20 mm mineral wool	20 mm mineral wool	20 mm mineral wool	25 mm mineral wool	25 mm mineral wool
Extract filter	G4	G4	G4	G4	G4	G4
Supply filter	G4	G4	G4	G4	G4	G4
Connected air duct diameter [mm]	160	250	250	315	315	500x300
Weight [kg]	112	128	130	165	175	198
Heat recovery efficiency [%]	80-95	76-95	72-95	73-95	72-95	68-93
Heat exchanger type	rotary	rotary	rotary	rotary	rotary	rotary
Heat exchanger material	aluminium	aluminium	aluminium	aluminium	aluminium	aluminium
SEC class	A	A	A	NRVU*	NRVU*	NRVU*
ErP	2016, 2018	2016, 2018	2016, 2018	2016, 2018	2016, 2018	2016, 2018

\*Nonresidential Ventilation Unit.

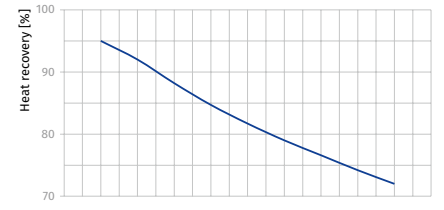
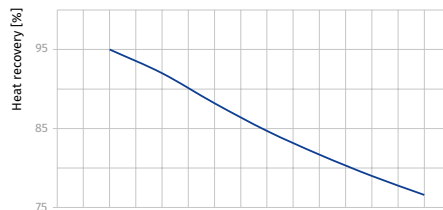
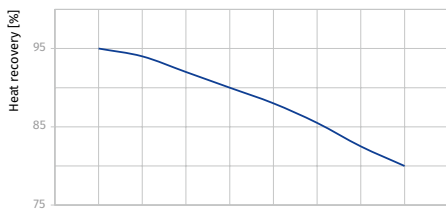
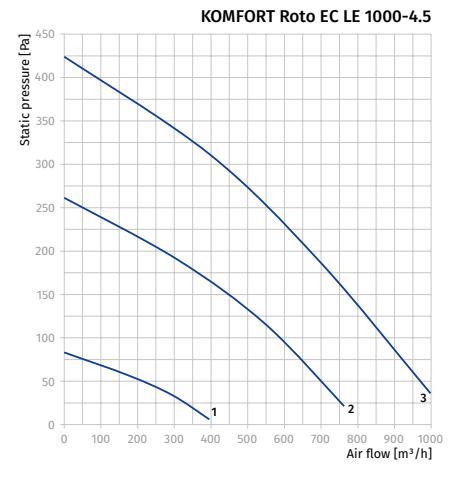
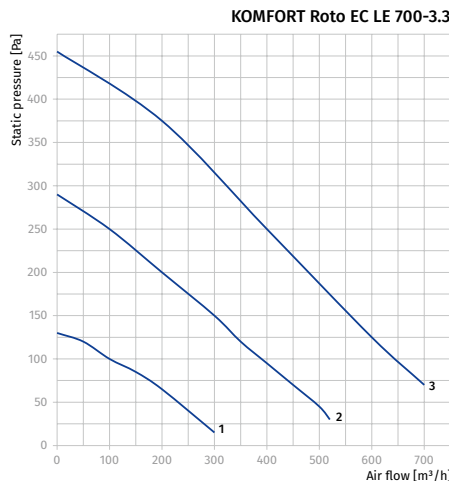
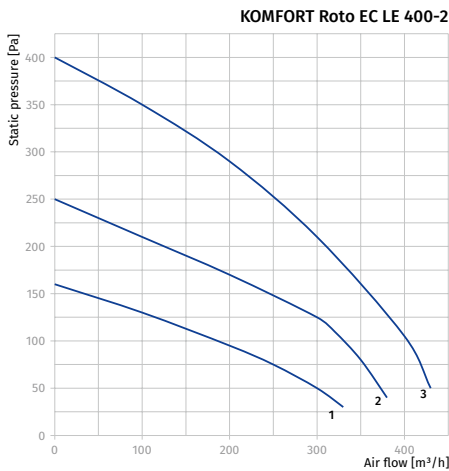



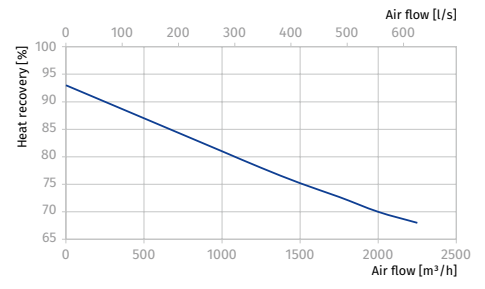
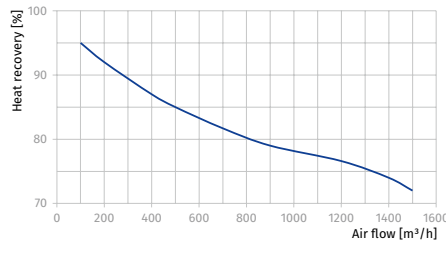
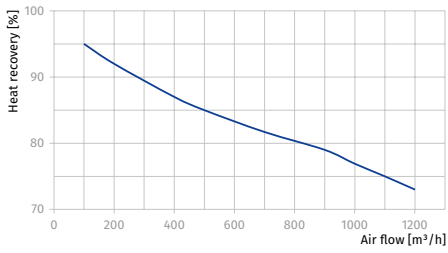
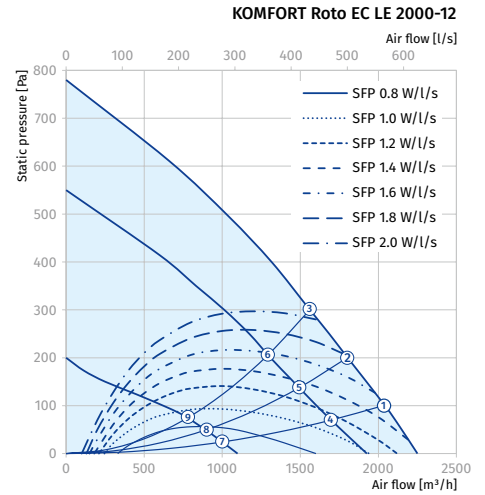
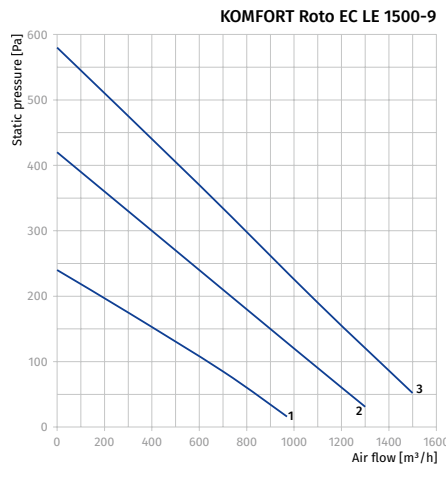
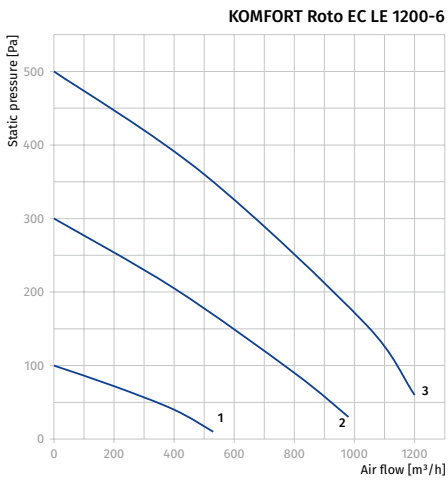

**Total power of the unit, W**

Point	KOMFORT Roto EC LE 2000-12
1	874
2	893
3	905
4	545
5	562
6	568
7	181
8	182
9	184

Parameters	KOMFORT Roto EC LW 400-2 S17/S18	KOMFORT Roto EC LW 700-2 S17/S18	KOMFORT Roto EC LW 1000-2 S17/S18	KOMFORT Roto EC LW 1200-2 S17/S18	KOMFORT Roto EC LW 1500-2 S17/S18	KOMFORT Roto EC LW 2000-2 S17/S18
Voltage [V / 50 (60) Hz]	1 ~ 230	1 ~ 230	1 ~ 230	1 ~ 230	1 ~ 230	1 ~ 230
Max. power without electric heater [W]	2 items x 100	2 items x 105	2 items x 135	2 items x 208	2 items x 222	2 items x 448
Max. power with electric heater [W]	290	315	440	570	750	1070
Max. current with electric heater [A]	1.2	1.4	1.9	2.5	3.2	5
Maximum air flow [m <sup>3</sup> /h (l/s)]	400 (111)	700 (194)	900 (250)	1200 (333)	1500 (417)	2250 (625)
Sound pressure level at 3 m [dBA]	45	52	58	60	62	64
Transported air temperature [°C]	-25...+40	-25...+40	-25...+40	-25...+40	-25...+40	-25...+40
Casing material	aluzinc	aluzinc	aluzinc	aluzinc	aluzinc	aluzinc
Insulation	20 mm mineral wool	20 mm mineral wool	20 mm mineral wool	20 mm mineral wool	25 mm mineral wool	25 mm mineral wool
Extract filter	G4	G4	G4	G4	G4	G4
Supply filter	G4	G4	G4	G4	G4	G4
Connected air duct diameter [mm]	160	250	250	315	315	500x300
Weight [kg]	112	128	130	165	175	198
Heat recovery efficiency [%]	80-95	76-95	72-95	73-95	72-95	68-93
Heat exchanger type	up to 85	up to 85	up to 85	up to 85	up to 85	up to 85
Heat exchanger type	rotary	rotary	rotary	rotary	rotary	rotary
Heat exchanger material	aluminium	aluminium	aluminium	aluminium	aluminium	aluminium
SEC class	A	A	A	NRVU*	NRVU*	NRVU*
ErP	2016, 2018	2016, 2018	2016, 2018	2016, 2018	2016, 2018	2016, 2018

\*Nonresidential Ventilation Unit.

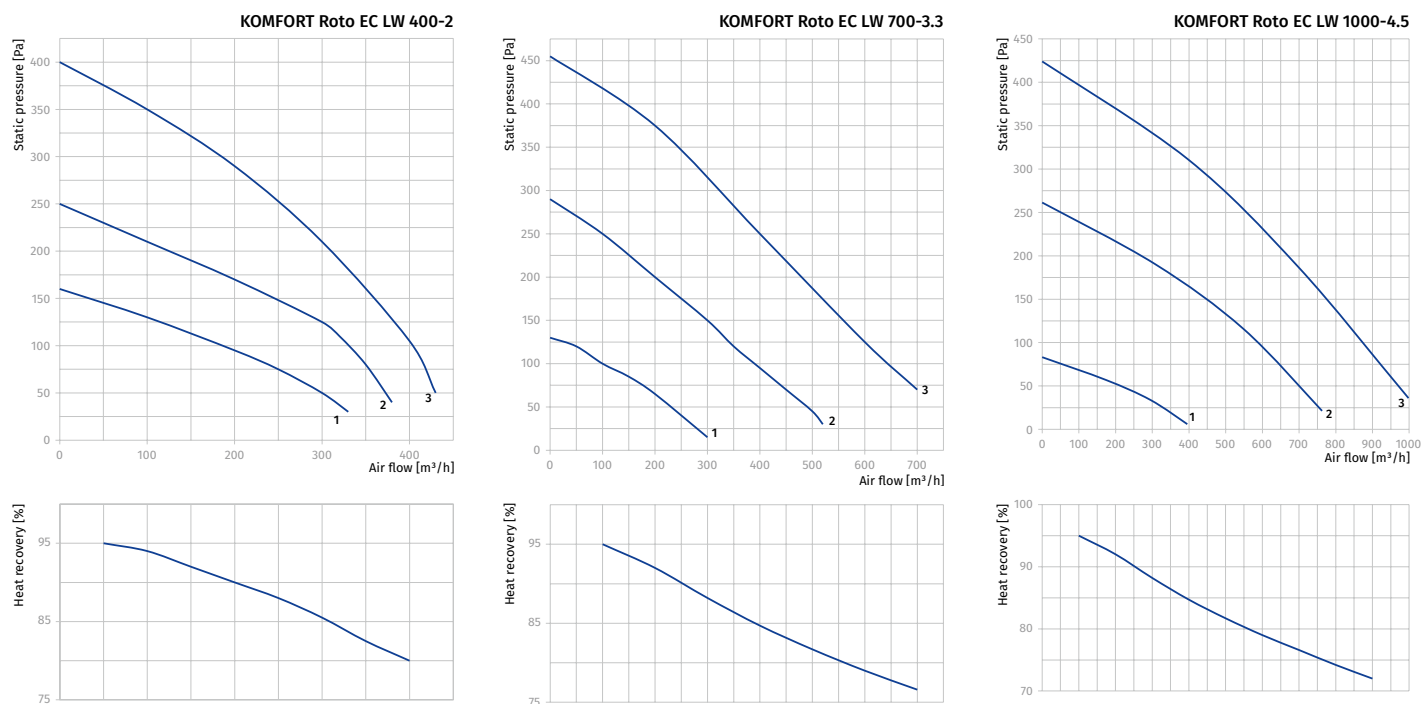

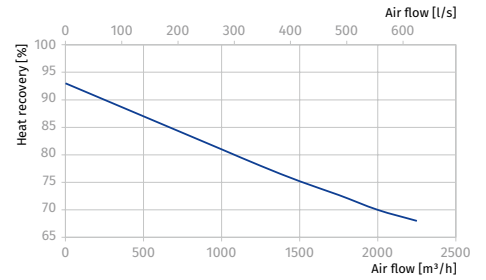
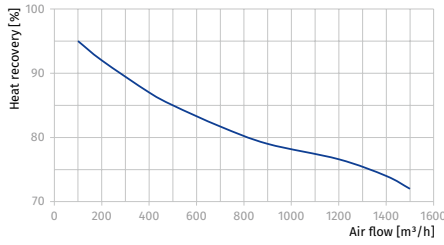
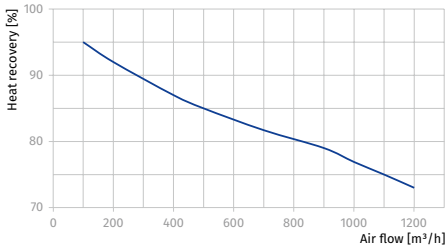
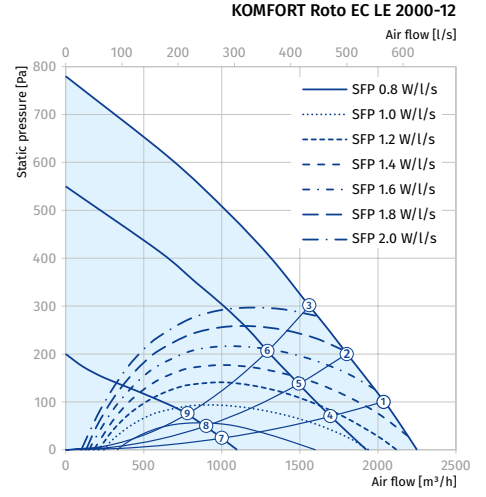
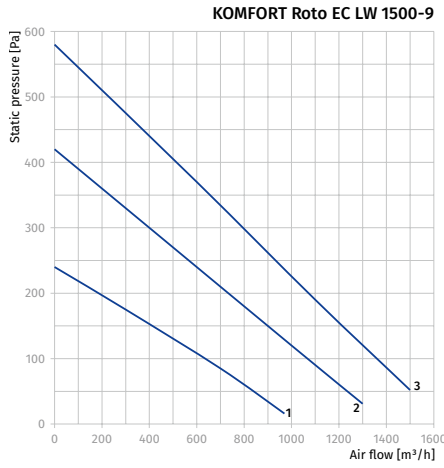
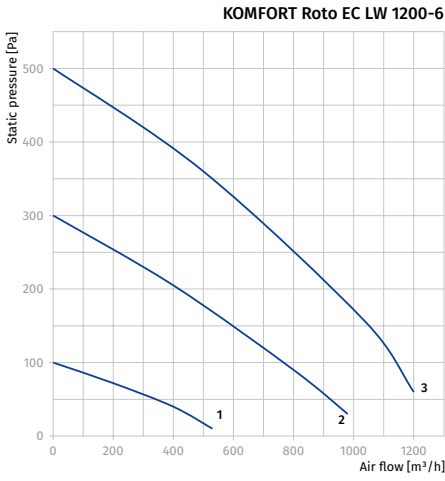

**Total power of the unit, W**

Point	KOMFORT Roto EC LE 2000-12
1	874
2	893
3	905
4	545
5	562
6	568
7	181
8	182
9	184

### Calculation of water heater parameters of the unit

KOMFORT Roto EC LW 400-2 / KOMFORT Roto EC LW 700-2 / KOMFORT Roto EC LW 1000-2

Air temperature downstream of the water heating coils [°C]

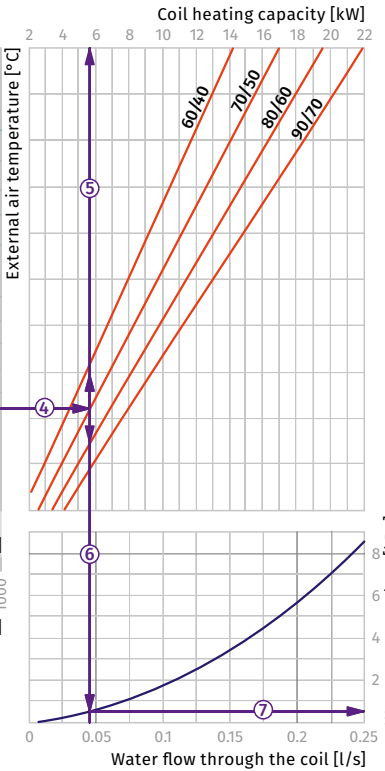
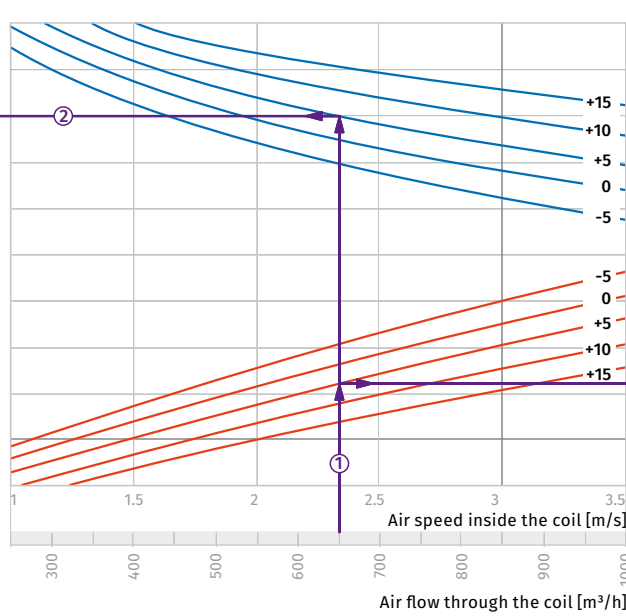
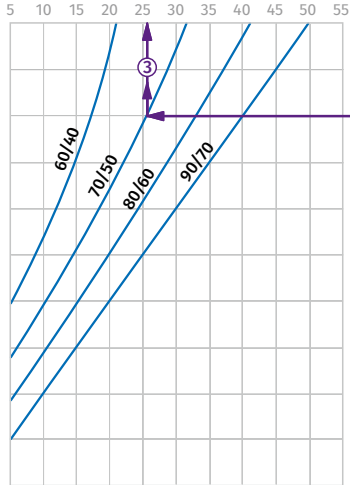

**How to use water heater diagrams.**

Sample parameters: Air flow = 650 m<sup>3</sup>/h.  
Outside air temperature = +5 °C.  
Water temperature (in/out) = +70/+50 °C.  
The air flow is 650 m<sup>3</sup>/h and the air speed in the heater is 2.35 m/s ①.

- To calculate the maximum air temperature find the intersection point of the air flow line ① with the rated outer temperature shown in blue line (e.g., +5 °C) and draw the line ② to the left until it crosses the water in/out temperature curve (e.g., +70/+50). From this point draw a vertical line to the supply air temperature downstream of the heater (+26 °C) ③.

- To calculate the heater power find the intersection point of the air flow ① with the rated winter temperature shown in red line (e.g., +5 °C) and draw the line ④ to the right until it crosses the water in/out temperature curve (e.g., +70/+50). From this point draw a vertical line to the heater power axis (5.8 kW) ⑤.

- To calculate the required water flow in the heater prolong this line ⑥ downwards to the water flow axis (0.04 l/s).
- To calculate the water pressure drop in the heater find the intersection point of the line ⑥ with the pressure loss curve and prolong the line ⑦ to the right on the water pressure drop axis (0.5 kPa).

### KOMFORT ROTO EC LW 1200-2

Air temperature downstream of the water heating coils [°C]

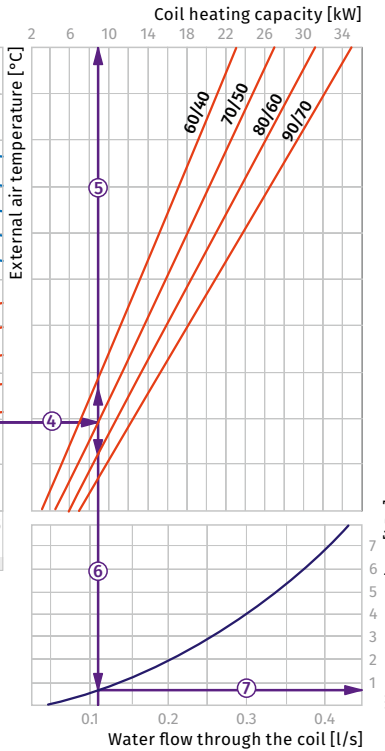
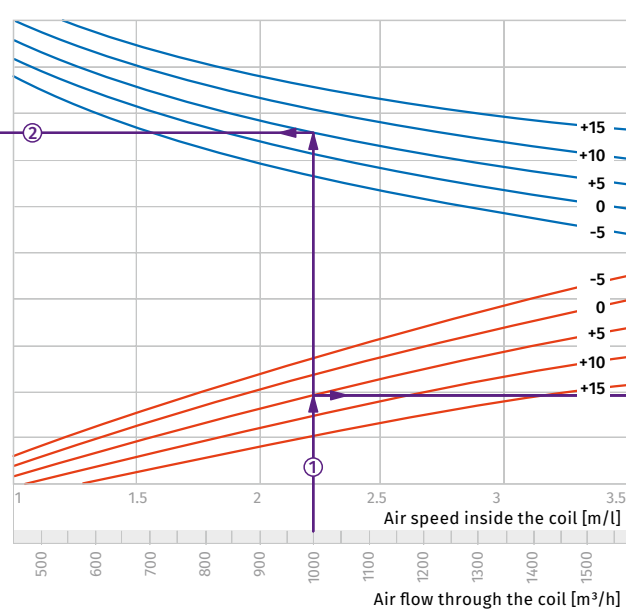
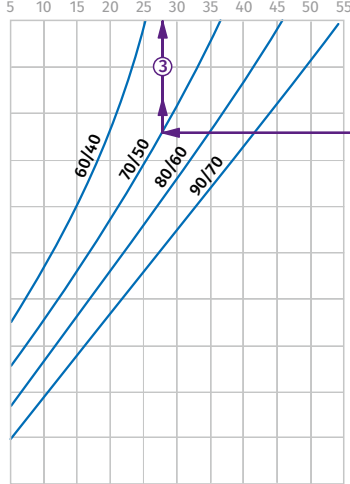

**How to use water heater diagrams.**

Sample parameters: Air flow = 1000 m<sup>3</sup>/h.  
Outside air temperature = +5 °C.  
Water temperature (in/out) = +70/+50 °C.  
The air flow is 1000 m<sup>3</sup>/h and the air speed in the heater is 2.22 m/s ①.

- To calculate the maximum air temperature find the intersection point of the air flow line ① with the rated outer temperature shown in blue line (e.g., +5 °C) and draw the line ② to the left until it crosses the water in/out temperature curve (e.g., +70/+50). From this point draw a vertical line to the supply air temperature downstream of the heater (+28 °C) ③.

- To calculate the heater power find the intersection point of the air flow ① with the rated winter temperature shown in red line (e.g., +5 °C) and draw the line ④ to the right until it crosses the water in/out temperature curve (e.g., +70/+50). From this point draw a vertical line to the heater power axis (9.0 kW) ⑤.

- To calculate the required water flow in the heater prolong this line ⑥ downwards to the water flow axis (0.11 l/s).
- To calculate the water pressure drop in the heater find the intersection point of the line ⑥ with the pressure loss curve and prolong the line ⑦ to the right on the water pressure drop axis (0.8 kPa).

**KOMFORT ROTO EC LW 1500-2 / KOMFORT ROTO EC LW 2000-2**

Air temperature downstream of the water heating coils [°C]

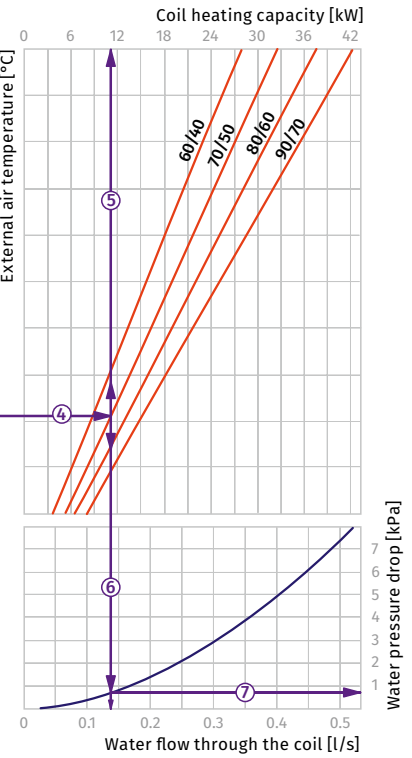
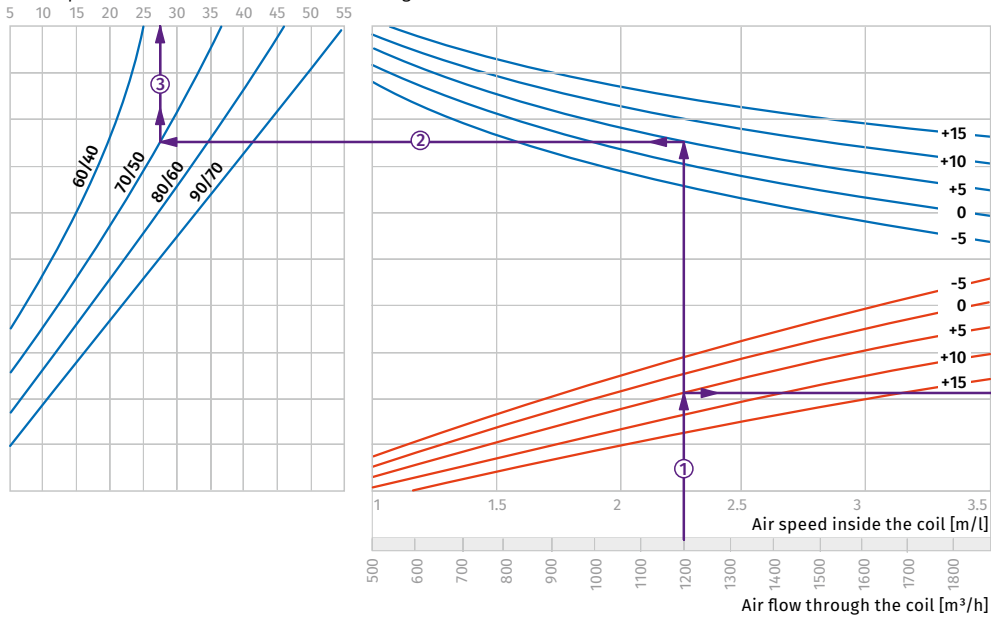

**How to use water heater diagrams.**

Sample parameters: Air flow = 1200 m<sup>3</sup>/h.  
 Outside air temperature = +5 °C.  
 Water temperature (in/out) = +70/+50 °C.  
 The air flow is 1200 m<sup>3</sup>/h and the air speed in the heater is 2.25 m/s ①.

- To calculate the maximum air temperature find the intersection point of the air flow line ① with the rated outer temperature shown in blue line (e.g., +5 °C) and draw the line ② to the left until it crosses the water in/out temperature curve (e.g., +70/+50). From this point draw a vertical line to the supply air temperature downstream of the heater (+27 °C) ③.
- To calculate the heater power find the intersection point of the air flow ① with the rated winter temperature shown in red line (e.g., +5 °C) and draw the line ④ to the right until it crosses the water in/out temperature curve (e.g., +70/+50). From this point draw a vertical line to the heater power axis (11.0 kW) ⑤.
- To calculate the required water flow in the heater prolong this line ⑥ downwards to the water flow axis (0.13 l/s).
- To calculate the water pressure drop in the heater find the intersection point of the line ⑥ with the pressure loss curve and prolong the line ⑦ to the right on the water pressure drop axis (0.8 kPa).

**Accessories**
**KOMFORT ROTO EC LE**

		KOMFORT Roto EC LE 400-2 S17/S18	KOMFORT Roto EC LE 700-3.3 S17/S18	KOMFORT Roto EC LE 1000-4.5 S17/S18	KOMFORT Roto EC LE 1200-6 S17/S18	KOMFORT Roto EC LE 1500-9 S17/S18	KOMFORT Roto EC LE 2000-12 S17/S18
G4 extract panel filter		FP 600x324x48 G4	FP 700x332x48 G4	FP 700x332x48 G4	FP 700x410x48 G4	FP 800x477x47 G4	FP 800x477x47 G4
G4 supply pocket filter		FPT 393x235x27 G4	FPT 700x333x27 G4	FPT 700x333x27 G4	FPT 700x423x27 G4	FPT 800x477x27 G4	FPT 800x477x27 G4
Silencer		SD 160	SD 250	SD 250	SD 315	SD 315	-
Backdraft air damper		VRV 160	VRV 250	VRV 250	VRV 315	VRV 315	-
Backdraft air damper		-	-	-	-	-	VRVS 500x300
Air damper		VRVS 160	VRVS 250	VRVS 250	VRVS 315	VRVS 315	-
Air damper		-	-	-	-	-	VK 500x300
VOC sensor		DPWQ30600	DPWQ30600	DPWQ30600	DPWQ30600	DPWQ30600	DPWQ30600
External CO <sub>2</sub> sensor		DPWQ40200	DPWQ40200	DPWQ40200	DPWQ40200	DPWQ40200	DPWQ40200
Humidity sensor		DPWC11200	DPWC11200	DPWC11200	DPWC11200	DPWC11200	DPWC11200
Humidity sensor		HR-S	HR-S	HR-S	HR-S	HR-S	HR-S
Humidity sensor		FS2	FS2	FS2	FS2	FS2	FS2
Electric actuator		TF230	TF230	TF230	TF230	TF230	TF230

**KOMFORT ROTO EC LW**

		KOMFORT Roto EC LW 400-2 S17/S18	KOMFORT Roto EC LW 700-2 S17/S18	KOMFORT Roto EC LW 1000-2 S17/S18	KOMFORT Roto EC LW 1200-2 S17/S18	KOMFORT Roto EC LW 1500-2 S17/S18	KOMFORT Roto EC LW 2000-2 S17/S18
G4 extract panel filter		FP 600x324x48 G4	FP 700x332x48 G4	FP 700x332x48 G4	FP 700x410x48 G4	FP 800x477x47 G4	FP 800x477x47 G4
G4 supply pocket filter		FPT 393x235x27 G4	FPT 700x333x27 G4	FPT 700x333x27 G4	FPT 700x423x27 G4	FPT 800x477x27 G4	FPT 800x477x27 G4
Water mixing unit		WMG 3/4-4	WMG 3/4-4	WMG 3/4-4	WMG 3/4-4	WMG 1-6	WMG 1-6
Silencer		SD 160	SD 250	SD 250	SD 315	SD 315	-
Backdraft air damper		VRV 160	VRV 250	VRV 250	VRV 315	VRV 315	-
Backdraft air damper		-	-	-	-	-	VRVS 500x300
Air damper		VRVS 160	VRVS 250	VRVS 250	VRVS 315	VRVS 315	-
Air damper		-	-	-	-	-	VK 500x300
VOC sensor		DPWQ30600	DPWQ30600	DPWQ30600	DPWQ30600	DPWQ30600	DPWQ30600
External CO <sub>2</sub> sensor		DPWQ40200	DPWQ40200	DPWQ40200	DPWQ40200	DPWQ40200	DPWQ40200
Humidity sensor		DPWC11200	DPWC11200	DPWC11200	DPWC11200	DPWC11200	DPWC11200
Humidity sensor		HR-S	HR-S	HR-S	HR-S	HR-S	HR-S
Humidity sensor		FS2	FS2	FS2	FS2	FS2	FS2
Electric actuator		TF230	TF230	TF230	TF230	TF230	TF230

AIR HANDLING UNITS WITH ROTARY HEAT EXCHANGER

# KOMFORT RoTo EC DE S21

## Suspended heat recovery air handling units

### Features

- Air handling units for efficient supply and exhaust ventilation in flats, houses, cottages and other buildings.
- Heat recovery is provided by the rotary heat exchanger and minimizes ventilation heat losses.
- Controllable air exchange for creating the best suitable indoor microclimate.
- Compatible with round Ø 160 and 200 mm air ducts.
- Additional spigot for kitchen hood air duct connection.



**Air flow:**  
up to 710 m<sup>3</sup>/h  
197 l/s



**Heat recovery efficiency:**  
up to 87 %



### Design

- The fan casing is made of galvanized steel, internally filled with mineral wool layer for heat and sound insulation.
- The spigots are located at the sides of the unit and are rubber sealed for airtight connection to the air ducts.
- **KOMFORT Roto EC D(2)E** – model with electric heater.
- The insulation of **KOMFORT Roto EC DE** is 40 mm, for **KOMFORT Roto EC D2E** is 20 mm.
- Unit maintenance is performed from the bottom panel side.
- The distinctive feature of **KOMFORT Roto EC D2E** is a low casing profile.

### Kitchen hood

- All the models are equipped with a fifth spigot for connection of the air duct from the kitchen hood.

### Air filtration

- Two built-in filters with G4 and F7 filtration class provide efficient supply air filtration. Optionally, a H13 supply air filter may be used.
- The G4 filter is used for extract air filtration.

### Motors

- High-efficient external rotor EC motors and centrifugal impellers with forward curved blades are used for air supply and exhaust.
- EC motors have the best power consumption to air flow ratio and meet the latest demands concerning energy saving and high-efficient ventilation.
- EC motors are featured with high performance, low noise level and totally controllable speed range.
- Dynamically balanced impellers.



AIR HANDLING UNITS WITH ROTARY HEAT EXCHANGER

### KOMFORT ROTO EC D(E) R (RIGHT SERVICE SIDE)

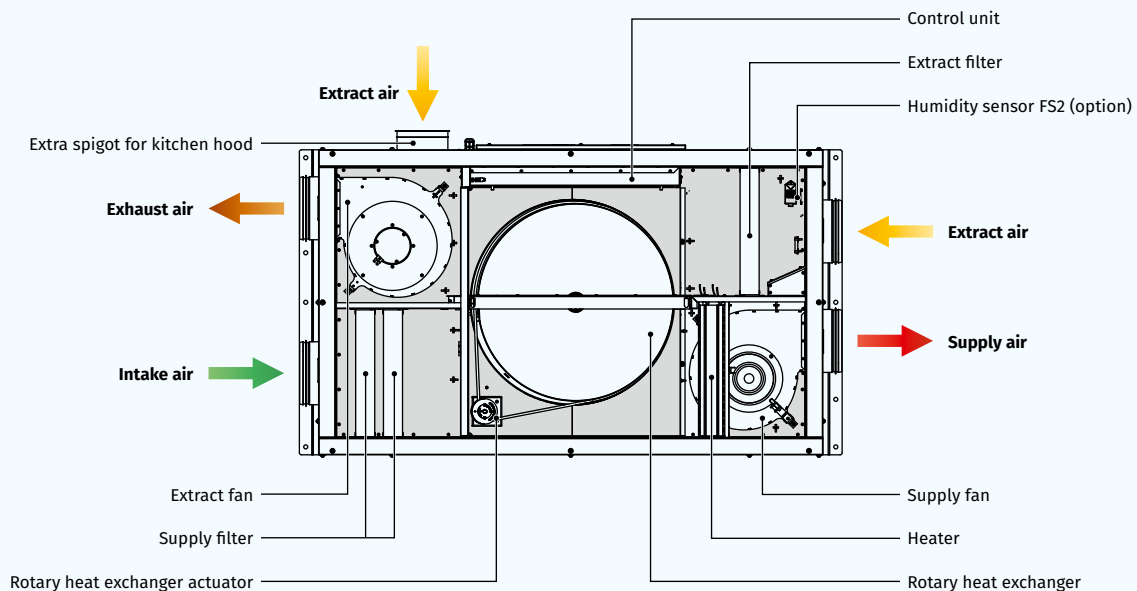



### Rotary heat exchanger

- The unit has a high-efficient rotary aluminium heat exchanger.
- The rotary heat exchanger is a short, rotating cylinder, filled with corrugated aluminium sheet layers. The air streams flow through them.
- The band layers of the heat exchanger first come in contact with the supply and then with extract air flows.
- Therefore the band is alternatively warmed up and cooled down and the extract air heat and humidity are transferred to the cold intake air. This way heat recovery reduces heat losses in the cold season and reduces operation load for air conditioner in the warm season.
- The advantages of the rotary heat exchanger as compared to the plate heat exchangers include no condensate generation, maintaining comfort air humidity and high freeze resistance.

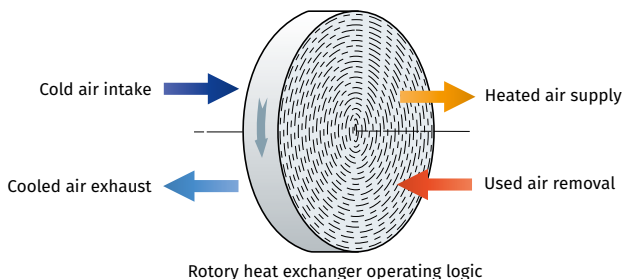

### Heater

- The **KOMFORT Roto EC D(2)E** units are equipped with the electric heater. If the necessary temperature level of the supply air cannot be achieved through heat recovery, the heater turns on automatically and heats the air supplied to the premise. The heaters incorporate protective measures securing the safe unit operation.

### Mounting

- The air handling unit is designed for suspension to a ceiling, wall mounting or mounting to a horizontal plane.

### Control and automation

- **KOMFORT EC D... S21** units are equipped with an integrated automation system. The remote control panel is not included in the delivery set (purchased separately).
- The S21 controller allows to integrate the unit into the **Smart Home** system or **BMS (Building Management System)**.
- The unit can be controlled via the **Blauberg AHU** mobile application via Wi-Fi.





Download the **Blauberg AHU** app for Android

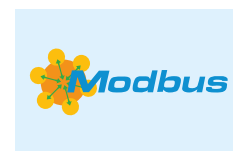

Download the **Blauberg AHU** app for iOS



### Automation functions

Functions	KOMFORT ROTO EC D(2)E S21
Control via Wi-Fi using a mobile application	+
Control via a wired remote control panel	S22 control panel (option) 
Control via a wireless remote control panel	S22 Wi-Fi control panel (option) 
Control via a wired remote LCD control panel	S25 control panel (option) 
BMS (Building Management System)	RS-485
	Wi-Fi
	Ethernet
	MODBUS (RTU, TCP)
Blauberg Cloud Server service	+
Speed selection	+
Filter replacement indication	by filter timer
Alarm indication	full alarm description in the mobile application
Week-scheduled operation	+
Timer	+
Boost mode	+
Fireplace mode	+
Cooler connection	option
Kitchen hood connection	option
Minimum supply air temperature control	+
Humidity control	option
CO <sub>2</sub> control	option
VOC control	option
PM2.5 control	option
Fire alarm sensor connection	option

Option: function is available when purchasing the appropriate accessory (see the "Accessories" section).

### Designation key

Series	Unit type	Motor type	Mounting type	Modification	Heater type	Rated air flow [m <sup>3</sup> /h]	Service side	Control
KOMFORT	<b>Roto:</b> rotary heat exchanger	<b>EC:</b> electronically commutated motor	<b>D:</b> suspended mounting, horizontally directed spigots	<b>_:</b> standard (insulation 40 mm) <b>2:</b> low-profile (insulation 20 mm)	<b>E:</b> electric heater	<b>250; 350; 650</b>	<b>L:</b> left <b>R:</b> right	<b>S21</b>

### Overall dimensions [mm]

Model	D	D1	B	B1	H	H1	L	L1
KOMFORT Roto EC DE 250 S21	160	125	643	688	308	345	1003	1100
KOMFORT Roto EC D2E 250 S21	160	125	618	666	225	245	1002	1097
KOMFORT Roto EC DE 350 S21	160	125	770	818	318	361	1270	1365
KOMFORT Roto EC D2E 350 S21	160	125	798	847	225	245	1362	1457
KOMFORT Roto EC DE 650 S21	200	125	897	932	409	422	1445	1542

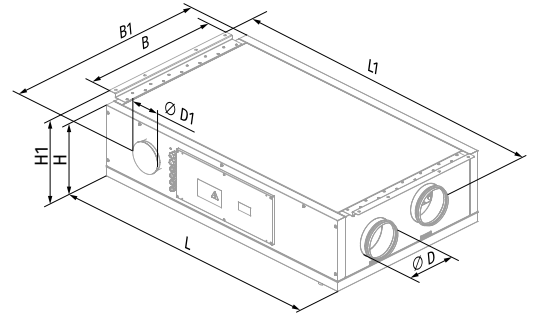

### Technical data

Parameters	KOMFORT Roto EC D2E 250 S21	KOMFORT Roto EC DE 250 S21
Voltage [V / 50 (60) Hz]	1~230	1~230
Maximum power [W]	828	835
Power of electric heater [W]	700	700
Power without heater [W]	128	135
Maximum current [A]	4.0	4.1
Current of electric heater [A]	3.1	3.1
Current without heater [A]	0.9	1.0
Maximum air flow [m <sup>3</sup> /h (l/s)]	300 (83)	310 (86)
Sound pressure level at 3 m [dBA]	23	21
Transported air temperature [°C]	-25...+40	-25...+40
Casing material	galvanized steel	galvanized steel
Insulation	20 mm mineral wool	40 mm mineral wool
Extract filter	G4	G4
Supply filter	G4, F7 (option: H13)	G4, F7 (option: H13)
Connected air duct diameter [mm]	160	160
Weight [kg]	54	56
Heat recovery efficiency [%]*	72-87	71-87
Heat exchanger type	rotary	rotary
Heat exchanger material	aluminum	aluminum
SEC class	A	A
ErP	2016, 2018	2016, 2018

\*Heat recovery efficiency is specified in compliance with EN 13141-7.

### KOMFORT ROTO EC D2E 250

Sound power level, A-weighted	Total	Octave frequency band [Hz]								LpA 3 m	LpA 1 m
		63	125	250	500	1000	2000	4000	8000		
LWA to supply inlet [dBA]	55	18	39	42	53	50	40	30	19		
LWA to supply outlet [dBA]	72	31	46	59	68	68	60	58	46		
LWA to exhaust inlet [dBA]	50	17	34	39	49	41	34	27	17		
LWA to exhaust outlet [dBA]	65	30	41	55	64	57	52	51	40		
LWA to environment [dBA]	41	8	25	36	35	33	30	29	27	21	31

Data provided for point 1 of the air flow diagram

Total power. Total sound pressure level.

Point	Total power of the unit [W]	Sound pressure level at 3 m (1m) [dBA]
1	93	23 (33)
2	89	23 (33)
3	77	22 (32)
4	41	21 (31)
5	39	19 (29)
6	38	18 (28)
7	17	18 (28)
8	17	17 (27)
9	16	17 (27)

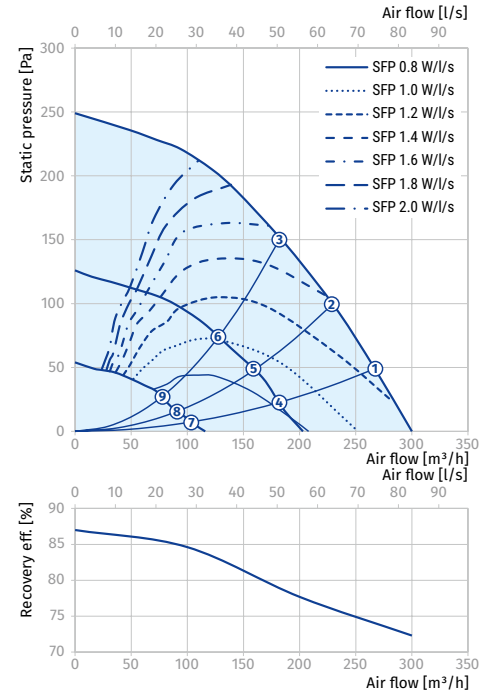

### KOMFORT ROTO EC DE 250

Sound power level, A-weighted	Total	Octave frequency band [Hz]								LpA 3 m	LpA 1 m
		63	125	250	500	1000	2000	4000	8000		
LWA to supply inlet [dBA]	58	21	42	45	56	53	42	32	21		
LWA to supply outlet [dBA]	59	21	43	45	56	53	42	32	21		
LWA to exhaust inlet [dBA]	53	20	38	42	52	44	36	29	18		
LWA to exhaust outlet [dBA]	54	20	38	43	53	44	36	29	18		
LWA to environment [dBA]	43	10	28	39	38	35	32	31	29	23	33

Data provided for point 1 of the air flow diagram

Total power. Total sound pressure level.

Point	Total power of the unit [W]	Sound pressure level at 3 m (1m) [dBA]
1	101	21 (31)
2	115	21 (31)
3	80	20 (30)
4	45	18 (28)
5	42	17 (27)
6	40	17 (27)
7	17	16 (26)
8	17	16 (26)
9	16	16 (26)

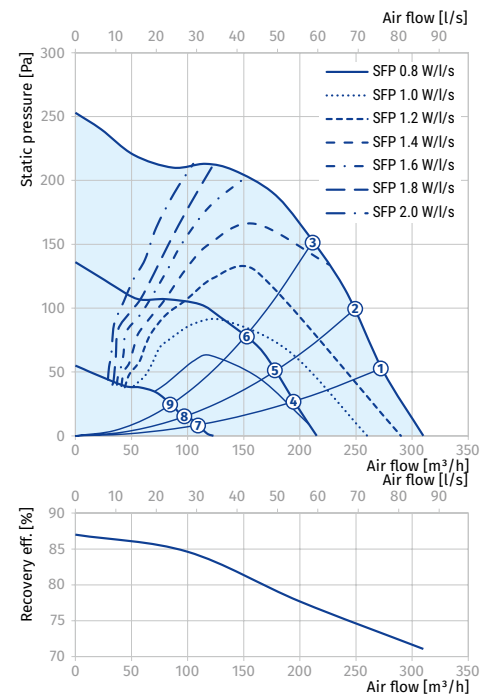

AIR HANDLING UNITS WITH ROTARY HEAT EXCHANGER

#### Calculation of air temperature downstream of the heat exchanger:

$$t = t_{\text{outd}} + k_{\text{hr}} \times (t_{\text{extr}} - t_{\text{outd}}) / 100,$$

where

$t_{\text{outd}}$  – outdoor air temperature [°C]

$t_{\text{extr}}$  – extract air temperature [°C]

$k_{\text{hr}}$  – heat exchanger efficiency (according to the diagram) [%]

Parameters	KOMFORT Roto EC D2E 350 S21	KOMFORT Roto EC DE 350 S21	KOMFORT Roto EC DE 650 S21
Voltage [V / 50 (60) Hz]	1~230	1~230	1~230
Maximum power [W]	1600	1585	3167
Power of electric heater [W]	1400	1400	2800
Power without heater [W]	200	185	367
Maximum current [A]	6.9	6.9	13.7
Current of electric heater [A]	5.6	5.6	11.2
Current without heater [A]	1.3	1.3	2.5
Maximum air flow [m <sup>3</sup> /h (l/s)]	400 (111)	430 (119)	710 (197)
Sound pressure level at 3 m [dBA]	33	31	36
Transported air temperature [°C]	-25...+40	-25...+40	-25...+40
Casing material	galvanized steel	galvanized steel	galvanized steel
Insulation	20 mm mineral wool	40 mm mineral wool	40 mm mineral wool
Extract filter	G4	G4	G4
Supply filter	G4, F7 (option: H13)	G4, F7 (option: H13)	G4, F7 (option: H13)
Connected air duct diameter [mm]	160	160	200
Weight [kg]	79	82	104
Heat recovery efficiency [%]*	73-87	72-87	80-87
Heat exchanger type	rotary	rotary	rotary
Heat exchanger material	aluminum	aluminum	aluminum
SEC class	A	A	A
ErP	2016, 2018	2016, 2018	2016, 2018

\*Heat recovery efficiency is specified in compliance with EN 13141-7.

### KOMFORT ROTO EC D2E 350

Sound power level, A-weighted	Total	Octave frequency band [Hz]								LpA 3 m	LpA 1 m
		63	125	250	500	1000	2000	4000	8000		
L <sub>WA</sub> to supply inlet [dBA]	59	26	45	53	54	52	48	43	34		
L <sub>WA</sub> to supply outlet [dBA]	83	44	58	67	75	75	79	75	71		
L <sub>WA</sub> to exhaust inlet [dBA]	54	25	40	50	50	43	41	38	30		
L <sub>WA</sub> to exhaust outlet [dBA]	74	42	52	63	70	63	68	66	62		
L <sub>WA</sub> to environment [dBA]	53	18	35	46	49	48	43	37	33	33	43

Data provided for point 1 of the air flow diagram

#### Total power. Total sound pressure level.

Point	Total power of the unit [W]	Sound pressure level at 3 m (1 m) [dBA]
1	172	33 (43)
2	171	33 (43)
3	167	32 (42)
4	125	31 (41)
5	124	28 (38)
6	122	27 (37)
7	98	27 (37)
8	97	23 (33)
9	97	23 (33)

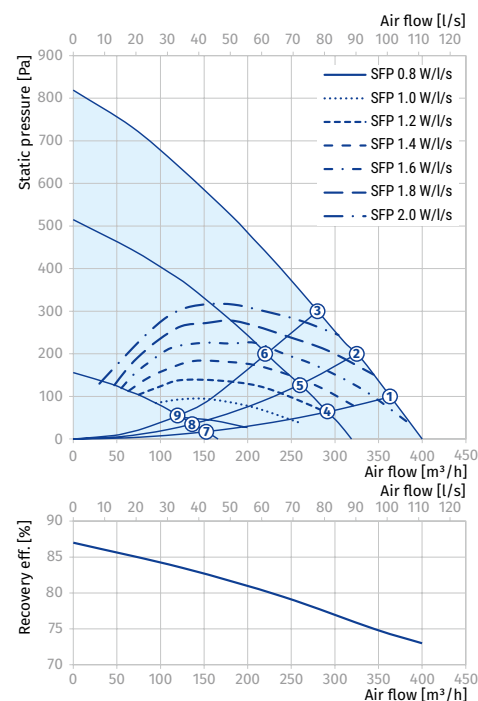

### KOMFORT ROTO EC DE 350

Sound power level, A-weighted	Total	Octave frequency band [Hz]								LpA 3 m	LpA 1 m
		63	125	250	500	1000	2000	4000	8000		
LWA to supply inlet [dBA]	56	24	43	51	52	50	46	42	33		
LWA to supply outlet [dBA]	80	41	55	65	72	72	76	72	69		
LWA to exhaust inlet [dBA]	52	23	38	47	48	42	39	37	29		
LWA to exhaust outlet [dBA]	72	40	50	61	67	61	65	64	60		
LWA to environment [dBA]	51	16	33	44	47	46	41	36	32	31	41

Data provided for point 1 of the air flow diagram

Total power. Total sound pressure level.

Point	Total power of the unit [W]	Sound pressure level at 3 m (1m) [dBA]
1	154	31 (41)
2	151	31 (41)
3	149	30 (40)
4	116	27 (37)
5	116	26 (36)
6	115	26 (36)
7	76	24 (34)
8	75	21 (31)
9	63	21 (31)

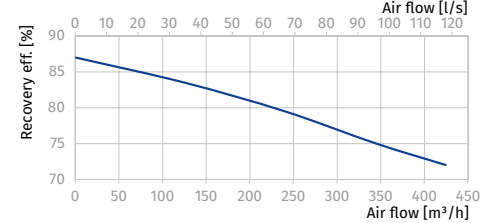
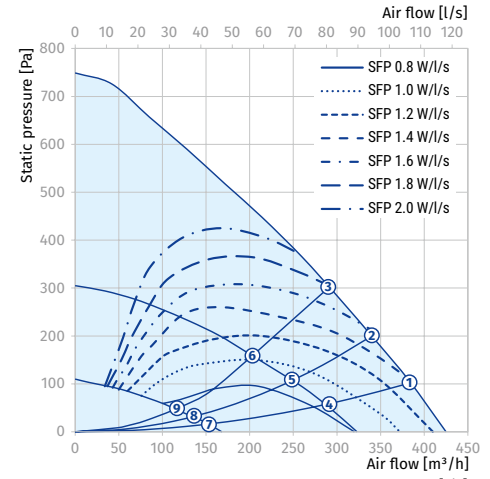

### KOMFORT ROTO EC DE 650

Sound power level, A-weighted	Total	Octave frequency band [Hz]								LpA 3 m	LpA 1 m
		63	125	250	500	1000	2000	4000	8000		
LWA to supply inlet [dBA]	79	56	62	64	74	72	74	71	66		
LWA to supply outlet [dBA]	68	48	51	57	67	52	49	42	30		
LWA to exhaust inlet [dBA]	81	55	60	64	77	73	75	71	66		
LWA to exhaust outlet [dBA]	67	47	51	58	65	58	57	48	39		
LWA to environment [dBA]	57	30	46	45	55	46	47	39	38	36	46







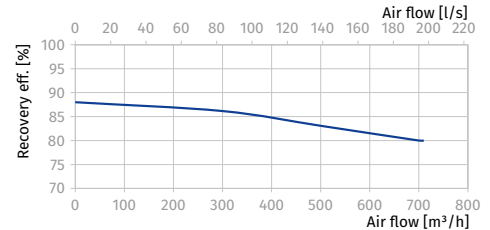
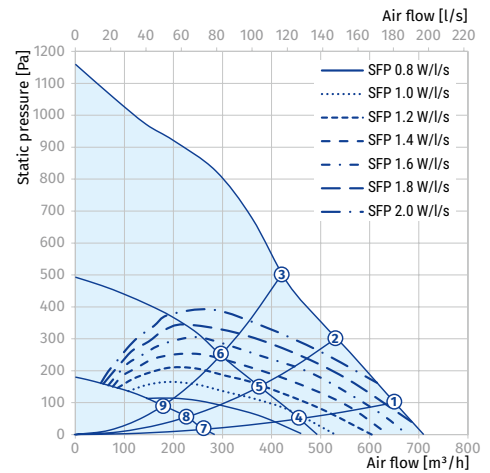







Data provided for point 1 of the air flow diagram















Total power. Total sound pressure level.

Point	Total power of the unit [W]	Sound pressure level at 3 m (1m) [dBA]
1	342	36 (46)
2	342	36 (46)
3	342	35 (45)
4	122	31 (41)
5	122	29 (39)
6	122	29 (39)
7	34	27 (37)
8	33	24 (34)
9	33	24 (34)



**Accessories**

		KOMFORT Roto EC D2E 250 S21	KOMFORT Roto EC DE 250 S21	KOMFORT Roto EC D2E 350 S21
G4 panel filter		FP 280x180x48 G4	FP 260x220x48 G4	FP 372x180x48 G4
F7 panel filter		FP 280x180x48 F7	FP 260x220x48 F7	FP 372x180x48 F7
H13 panel filter		FP 280x180x48 H13	FP 260x220x48 H13	FP 372x180x48 H13
Control panel		S22	S22	S22
Wireless control panel		S22 Wi-Fi	S22 Wi-Fi	S22 Wi-Fi
LCD control panel		S25	S25	S25
VOC sensor		DPWQ30600	DPWQ30600	DPWQ30600
External CO <sub>2</sub> sensor		DPWQ40200	DPWQ40200	DPWQ40200
Humidity sensor		DPWC11200	DPWC11200	DPWC11200
Humidity sensor		HR-S	HR-S	HR-S
Humidity sensor		FS2	FS2	FS2
Kitchen hood		DAH 251-13	DAH 251-13	DAH 251-13
Backdraft air damper		VRV 160	VRV 160	VRV 160
Air damper		VKA 160	VKA 160	VKA 160
Electric actuator		TF230	TF230	TF230

		KOMFORT Roto EC DE 350 S21	KOMFORT Roto EC DE 650 S21
G4 panel filter		FP 320x235x48 G4	FP 378x295x48 G4
F7 panel filter		FP 320x235x48 F7	FP 378x295x48 F7
H13 panel filter		FP 320x235x48 H13	FP 378x295x48 H13
Control panel		S22	S22
Wireless control panel		S22 Wi-Fi	S22 Wi-Fi
LCD control panel		S25	S25
VOC sensor		DPWQ30600	DPWQ30600
External CO <sub>2</sub> sensor		DPWQ40200	DPWQ40200
Humidity sensor		DPWC11200	DPWC11200
Humidity sensor		HR-S	HR-S
Humidity sensor		FS2	FS2
Kitchen hood		DAH 251-13	DAH 251-13
Backdraft air damper		VRV 160	VRV 200
Air damper		VKA 160	VKA 200
Electric actuator		TF230	TF230

AIR HANDLING UNITS WITH ROTARY HEAT EXCHANGER

# BLAUBOX EC ME

## Supply ventilation units

### Features

- Ventilation unit for efficient supply ventilation in various premises.
- Controllable air supply, heating and filtration.
- BMS connection via ModBUS RTU.



**Air flow:**  
up to 5000 m<sup>3</sup>/h  
1389 l/s



### Design

- Steel casing covered with aluzinc coating internally filled with 30 mm heat- and sound-insulating layer made of mineral wool.
- Mounting brackets with anti-vibration rubber. Service panel ensures easy access to the internals.
- **Blaubox EC ME 300 ... 700** are compatible with round ducts.

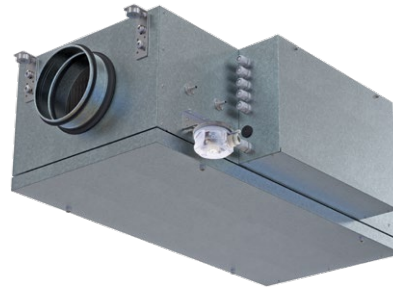

Blaubox EC ME 300 ... 700

#### Blaubox EC ME 300 ... 700

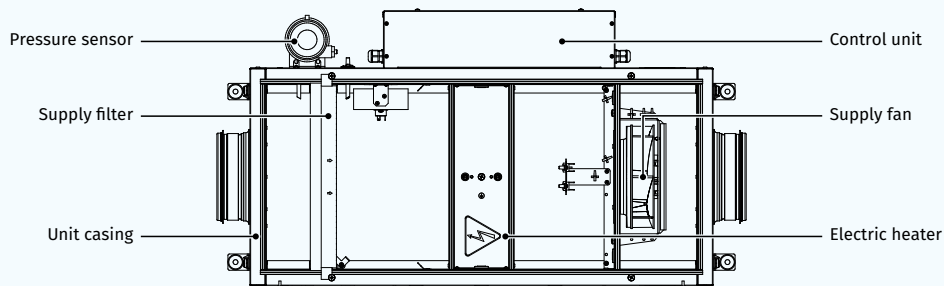

#### Blaubox EC ME 1000 ... 4000

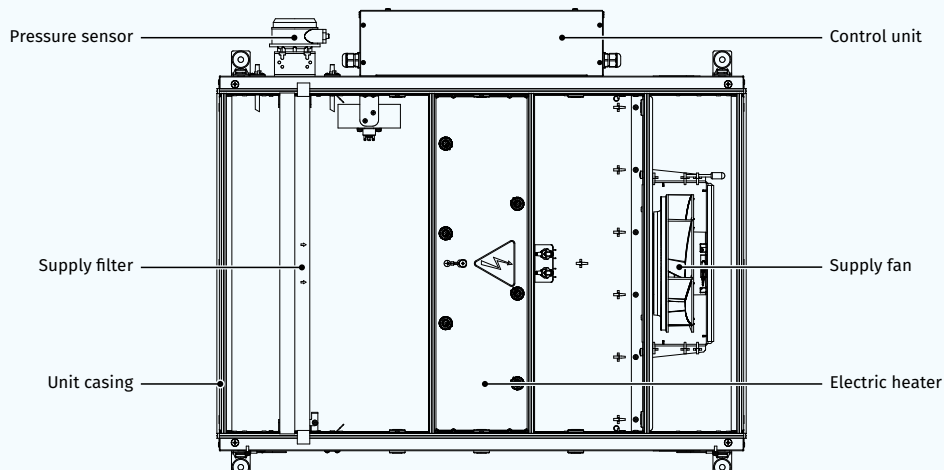



### Fans

- o Efficient external rotor EC-motors and centrifugal impellers with backward curved blades.
- o EC-motors are featured with high performance, low noise level and totally controllable speed range.
- o Dynamically balanced impeller.

### Air filtration

- o Panel Coarse 60% (G4) filter for supply air purification.
- o Panel ePM10 90% (F7) filter is available as an option.

### Air heater

- o The unit is equipped with an electric heater.
- o Heating elements are extra ribbed for larger heat exchange surface.
- o Integrated overheat protection.



### Mounting

- o The unit is suitable for indoor mounting on the floor, ceiling mounting or wall mounting with fixing brackets in any mounting position, except for the vertical one with air flow downward.
- o The correctly mounted unit must provide free access to the service panel.

### Control and automation

- o The units are equipped with an S31 integrated automation control system.
- o Remote control panels are not included in the delivery set and ordered separately.

### Automation functions

Functions	Description
Wired control panel	S30 
Wired control panel	S32 
Unit on / off	+
Fan speed control and setting	+
Filter clogging indication and control	Pressure sensor
Week schedule	+
Electric heater protection with auto restart	+
Electric heater protection with manual restart	+
Supply temperature control	+
Outer temperature sensor	+
Water heater frost protection	+
Return temperature sensor	+
Air damper control	+
Alarm indication	+
BMS Connection	ModBUS (RTU)
Humidity sensor	0-10 V or NO
CO <sub>2</sub> Sensor	0-10 V or NO
Exhaust fan control	on / off
Three-way valve control	+
Circulation pump control	+
Condensing unit control	0-10 V

### Designation key

Series	Motor type	Heater type	Rated air flow [m³/h]	Electric heater power [kW]	Service side	Control
Blaubox: supply air unit	EC: electronically commutated motor	ME: electric	300; 400; 700; 1000; 1500; 2000; 3000; 4000	1.7; 2.0; 3.0; 5.1; 6.0; 9.0; 12.0; 14.0; 15.0; 18.0; 27.0; 45.0; 54.0	L: left R: right	S31

**Overall dimensions [mm]**

Model	∅ D	H	H1	L	L1	L2	W	W1	W2	W3
Blaubox EC ME 300 S31	160	290	-	850	903	950	400	514	313	-
Blaubox EC ME 400 S31	200	350	-	850	903	972	400	514	313	-
Blaubox EC ME 700 S31	250	350	-	850	903	972	460	565	353	-
Blaubox EC ME 1000 S31	-	380	200	900	770	-	600	653	746	400
Blaubox EC ME 1500 S31	-	440	250	900	770	-	700	754	847	500
Blaubox EC ME 2000 S31	-	440	300	900	770	-	700	754	847	500
Blaubox EC ME 3000 S31	-	500	300	1200	1070	-	800	853	944	600
Blaubox EC ME 4000 S31	-	550	400	1200	1070	-	940	993	1087	700

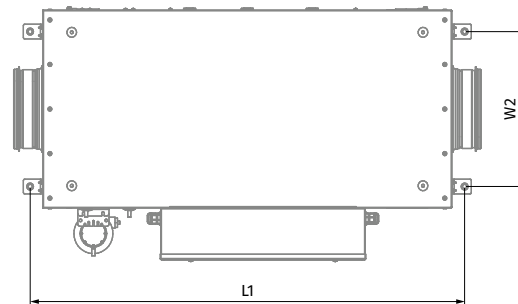
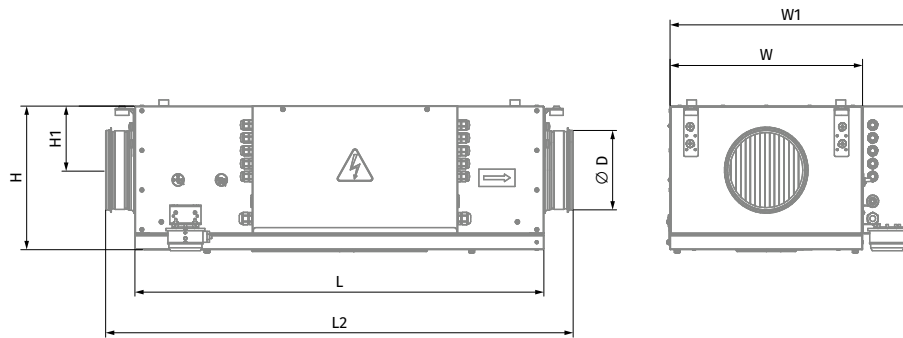

Blaubox EC ME 300 – Blaubox EC ME 700

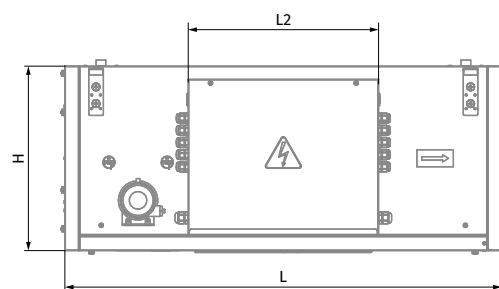
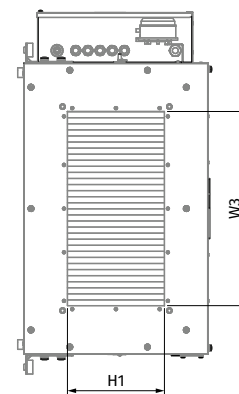
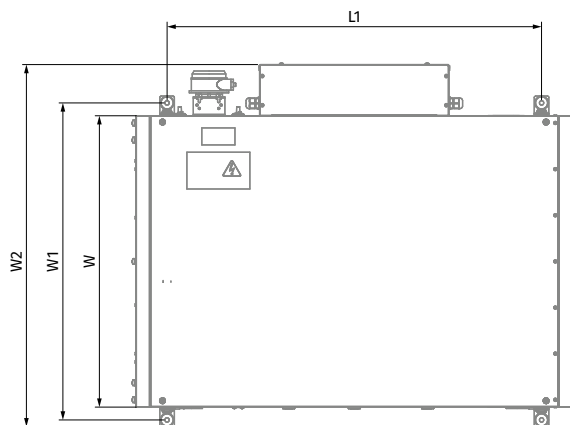

Blaubox EC ME 1000 – Blaubox EC ME 4000

**Technical data**

Parameters	Blaubox EC ME 300-1.7 S31	Blaubox EC ME 300-5.1 S31	Blaubox EC ME 400-2.4 S31	Blaubox EC ME 400-3.3 S31	Blaubox EC ME 400-6 S31
Supply voltage [V / 50 Hz]	1 ~ 230	3 ~ 400	1 ~ 230	3 ~ 400	3 ~ 400
Max. unit power without electric heater [kW]	0.064	0.064	0.062	0.062	0.062
Electric heater power [kW]	1.7	5.1	2.4	3.3	6.0
Max. power with electric heater [kW]	1.764	5.164	2.462	3.362	6.062
Max. unit current without electric heater [A]	0.3	0.3	0.5	0.5	0.5
Max. current with electric heater [A]	7.7	7.4	12	5.4	9.7
Maximum airflow [m³/h]	365	354	430	430	430
Sound pressure level at 3 m [dBA]	35	35	31	31	31
Transported air temperature [°C]	-30...+40	-30...+40	-30...+40	-30...+40	-30...+40
Casing material	aluzinc	aluzinc	aluzinc	aluzinc	aluzinc
Insulation	30 mm mineral wool	30 mm mineral wool	30 mm mineral wool	30 mm mineral wool	30 mm mineral wool
Filter	Coarse 90% / G4 (option: ePM1 70% / F7)	Coarse 90% / G4 (option: ePM1 70% / F7)	Coarse 90% / G4 (option: ePM1 70% / F7)	Coarse 90% / G4 (option: ePM1 70% / F7)	Coarse 90% / G4 (option: ePM1 70% / F7)
Connected air duct diameter [mm]	160	160	200	200	200
Weight [kg]	24	24	25	25	25

**BLAUBOX EC ME 300 S31**

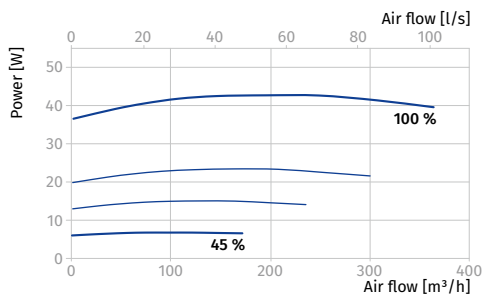
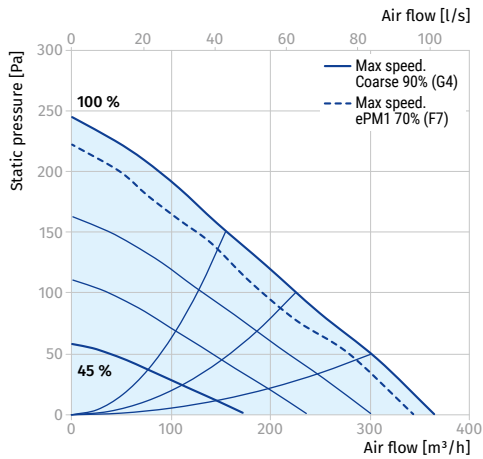

**BLAUBOX EC ME 400 S31**

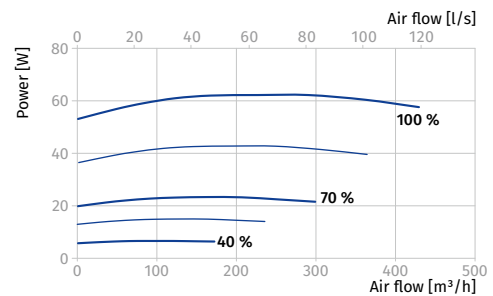
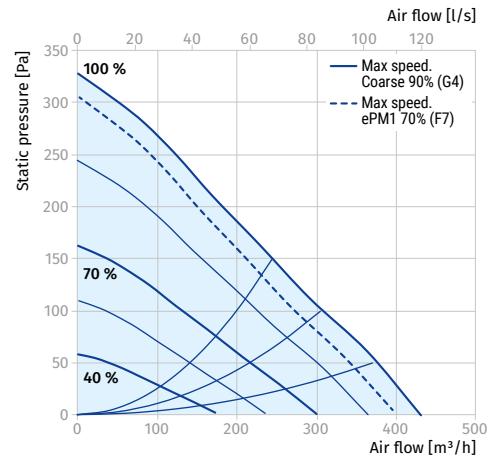

Parameters	Blaubox EC ME 700-3 S31	Blaubox EC ME 700-6 S31	Blaubox EC ME 700-9 S31	Blaubox EC ME 1000-6 S31	Blaubox EC ME 1000-12 S31	Blaubox EC ME 1000-15 S31
Supply voltage [V / 50 Hz]	3 ~ 400	3 ~ 400	3 ~ 400	3 ~ 400	3 ~ 400	3 ~ 400
Max. unit power without electric heater [kW]	0.116	0.116	0.116	0.165	0.165	0.165
Electric heater power [kW]	3.0	6.0	9.0	6.0	12.0	15.0
Max. power with electric heater [kW]	3.116	6.116	9.116	6.165	12.165	15.165
Max. unit current without electric heater [A]	0.5	0.5	0.5	1.3	1.3	1.3
Max. current with electric heater [A]	5	10	14.6	11	19.5	24.3
Maximum airflow [m³/h]	760	760	760	1000	1000	1000
Sound pressure level at 3 m [dBA]	41	41	41	45	45	45
Transported air temperature [°C]	-30...+40	-30...+40	-30...+40	-30...+40	-30...+40	-30...+40
Casing material	aluzinc	aluzinc	aluzinc	aluzinc	aluzinc	aluzinc
Insulation	30 mm mineral wool	30 mm mineral wool	30 mm mineral wool	30 mm mineral wool	30 mm mineral wool	30 mm mineral wool
Filter	Coarse 90% / G4 (option: ePM1 70% / F7)	Coarse 90% / G4 (option: ePM1 70% / F7)	Coarse 90% / G4 (option: ePM1 70% / F7)	Coarse 90% / G4 (option: ePM1 70% / F7)	Coarse 90% / G4 (option: ePM1 70% / F7)	Coarse 90% / G4 (option: ePM1 70% / F7)
Connected air duct diameter [mm]	250	250	250	400 × 200	400 × 200	400 × 200
Weight [kg]	27	27	27	30	30	30

**BLAUBOX EC ME 700 S31**

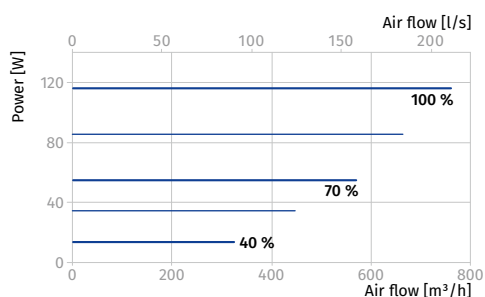
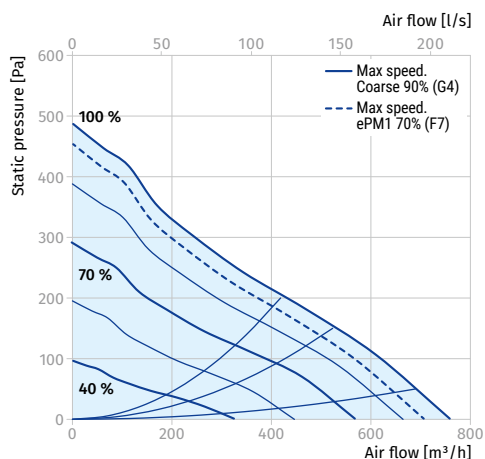

**BLAUBOX EC ME 1000 S31**

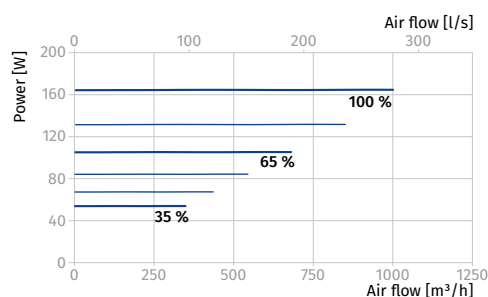
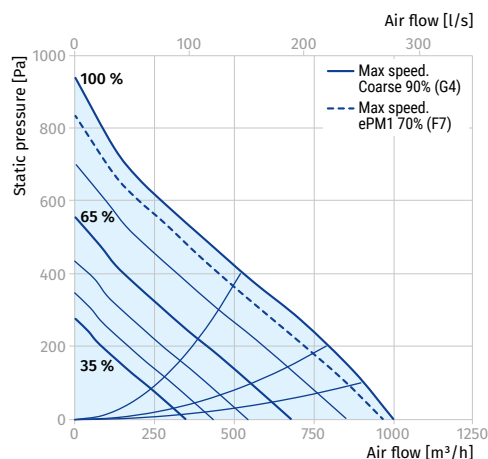

Parameters	Blaubox EC ME 1500-9 S31	Blaubox EC ME 1500-15 S31	Blaubox EC ME 1500-18 S31	Blaubox EC ME 2000-12 S31	Blaubox EC ME 2000-18 S31	Blaubox EC ME 2000-24 S31
Supply voltage [V / 50 Hz]	3 ~ 400	3 ~ 400	3 ~ 400	3 ~ 400	3 ~ 400	3 ~ 400
Max. unit power without electric heater [kW]	0.223	0.223	0.223	0.406	0.406	0.406
Electric heater power [kW]	9.0	15.0	18.0	12.0	18.0	24.0
Max. power with electric heater [kW]	9.223	15.223	18.223	12.406	18.406	24.406
Max. unit current without electric heater [A]	1.7	1.7	1.7	1.8	1.8	1.8
Max. current with electric heater [A]	14.8	22.8	29.2	19.9	29.5	39.1
Maximum airflow [m³/h]	1500	1500	1500	2450	2450	2450
Sound pressure level at 3 m [dBA]	46	46	46	48	48	48
Transported air temperature [°C]	-30...+40	-30...+40	-30...+40	-30...+40	-30...+40	-30...+40
Casing material	aluzinc	aluzinc	aluzinc	aluzinc	aluzinc	aluzinc
Insulation	30 mm mineral wool	30 mm mineral wool	30 mm mineral wool	30 mm mineral wool	30 mm mineral wool	30 mm mineral wool
Filter	Coarse 90% / G4 (option: ePM1 70% / F7)	Coarse 90% / G4 (option: ePM1 70% / F7)	Coarse 90% / G4 (option: ePM1 70% / F7)	Coarse 90% / G4 (option: ePM1 70% / F7)	Coarse 90% / G4 (option: ePM1 70% / F7)	Coarse 90% / G4 (option: ePM1 70% / F7)
Connected air duct diameter [mm]	500 × 250	500 × 250	500 × 250	500 × 300	500 × 300	500 × 300
Weight [kg]	35	35	35	40	40	40

**BLAUBOX EC ME 1500 S31**

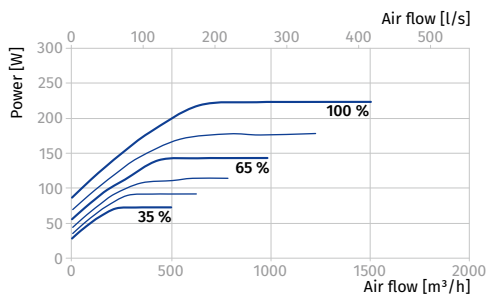
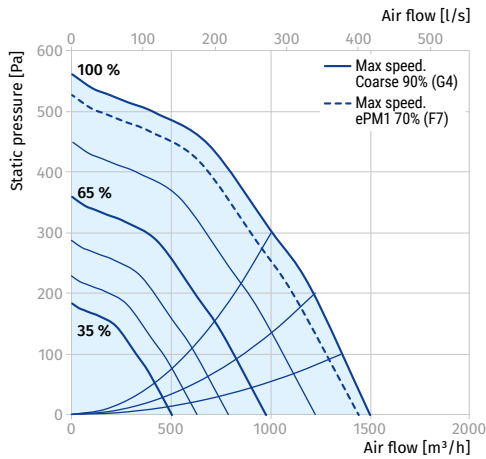

**BLAUBOX EC ME 2000 S31**

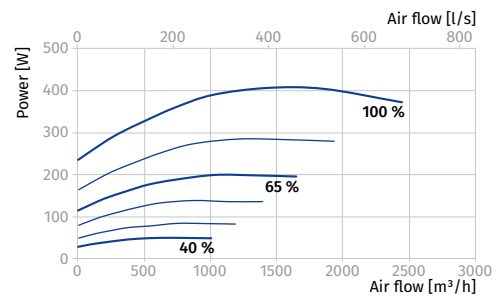
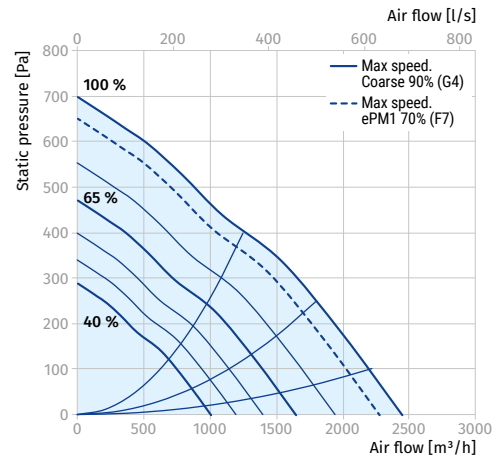

Parameters	Blaubox EC ME 3000-18 S31	Blaubox EC ME 3000-27 S32	Blaubox EC ME 3000-45 S33	Blaubox EC ME 4000-24 S34	Blaubox EC ME 4000-45 S35	Blaubox EC ME 4000-54 S36
Supply voltage [V / 50 Hz]	3 ~ 400	3 ~ 400	3 ~ 400	3 ~ 400	3 ~ 400	3 ~ 400
Max. unit power without electric heater [kW]	0.472	0.472	0.472	0.717	0.717	0.717
Electric heater power [kW]	18.0	27.0	45.0	24.0	45.0	54.0
Max. power with electric heater [kW]	18.472	27.472	45.472	24.717	45.717	54.717
Max. unit current without electric heater [A]	2.1	2.1	2.1	1.1	1.1	1.1
Max. current with electric heater [A]	29.6	44	72.8	42.9	73.2	87.6
Maximum airflow [m³/h]	3150	3150	3150	5000	5000	5000
Sound pressure level at 3 m [dBA]	47	47	47	49	49	49
Transported air temperature [°C]	-30...+40	-30...+40	-30...+40	-30...+40	-30...+40	-30...+40
Casing material	aluzinc	aluzinc	aluzinc	aluzinc	aluzinc	aluzinc
Insulation	30 mm mineral wool	30 mm mineral wool	30 mm mineral wool	30 mm mineral wool	30 mm mineral wool	30 mm mineral wool
Filter	Coarse 90% / G4 (option: ePM1 70% / F7)	Coarse 90% / G4 (option: ePM1 70% / F7)	Coarse 90% / G4 (option: ePM1 70% / F7)	Coarse 90% / G4 (option: ePM1 70% / F7)	Coarse 90% / G4 (option: ePM1 70% / F7)	Coarse 90% / G4 (option: ePM1 70% / F7)
Connected air duct diameter [mm]	600 × 300	600 × 300	600 × 300	700 × 400	700 × 400	700 × 400
Weight [kg]	50	50	50	60	60	60

**BLAUBOX EC ME 3000 S31**

**BLAUBOX EC ME 4000 S31**

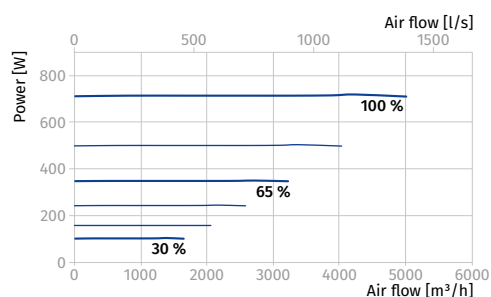
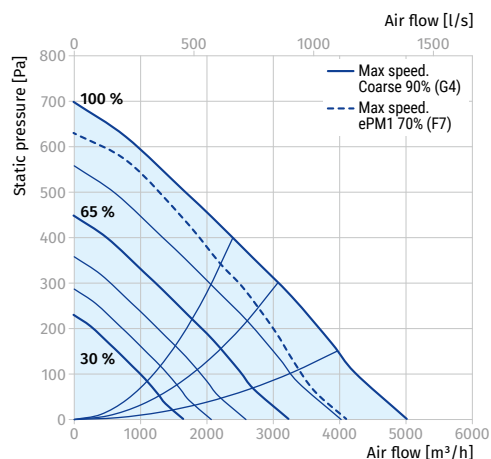
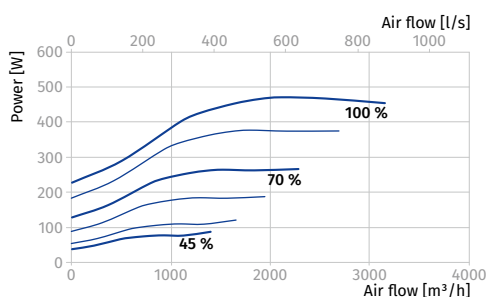
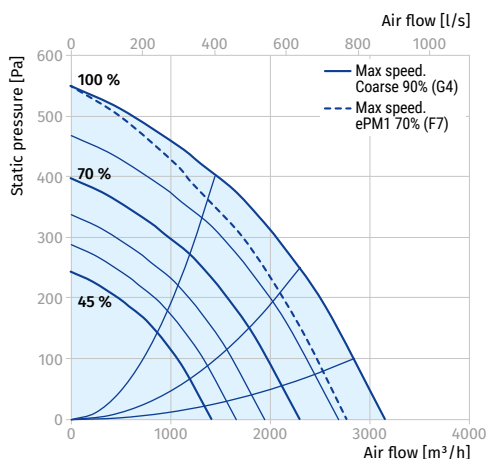

SUPPLY VENTILATION UNITS

**Accessories**

		Blaubox EC ME 300	Blaubox EC ME 400	Blaubox EC ME 700	Blaubox EC ME 1000
Panel filter G4		FP 334x226x48 Coarse 90% / G4	FP 334x287x48 Coarse 90% / G4	FP 384x287x48 Coarse 90% / G4	FP 536x316x48 Coarse 90% / G4
Panel filter F7		FP 334x226x48 ePM1 70% / F7	FP 334x287x48 ePM1 70% / F7	FP 384x287x48 ePM1 70% / F7	FP 536x316x48 ePM1 70% / F7
Flexible anti-vibration connector		EVA 125	EVA 200	EVA 250	EVA 40x20
Silencer		SD 125	SD 200	SD 250	SD 40x20
Air damper		VKA 125	VKA 200	VKA 250	SL 40x20
Air damper electric actuator		TF230 / TF24	TF230 / TF24	TF230 / TF24	TF230 / TF24

		Blaubox EC ME 1500	Blaubox EC ME 2000	Blaubox EC ME 3000	Blaubox EC ME 4000
Panel filter G4		FP 636x376x48 Coarse 90% / G4	FP 636x376x48 Coarse 90% / G4	FP 734x435x80 Coarse 90% / G4	FP 874x485x80 Coarse 90% / G4
Panel filter F7		FP 636x376x48 ePM1 70% / F7	FP 636x376x48 ePM1 70% / F7	FP 384x287x48 ePM1 70% / F7	FP 874x485x80 ePM1 70% / F7
Flexible anti-vibration connector		EVA 50x25	EVA 50x30	EVA 60x30	EVA 70x40
Silencer		SD 50x25	SD 50x30	SD 60x30	SD 70x40
Air damper		SL 50x25	SL 50x30	SL 60x30	SL 70x40
Air damper electric actuator		TF230 / TF24	TF230 / TF24	TF230 / TF24	TF230 / TF24

# BLAUBOX EC MW

## Supply ventilation units

### Features

- Ventilation unit for efficient supply ventilation in various premises.
- Controllable air supply, heating and filtration.
- BMS connection via ModBUS RTU.



**Air flow:**  
up to 4950 m<sup>3</sup>/h  
1375 l/s

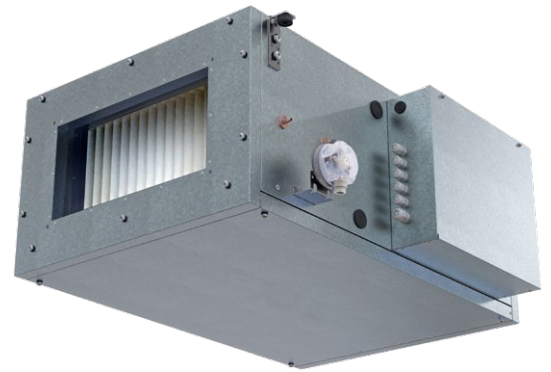

### Design

- Steel casing covered with aluzinc coating internally filled with 30 mm heat- and sound-insulating layer made of mineral wool.
- Mounting brackets with anti-vibration rubber. Service panel ensures easy access to the internals.
- **Blaubox EC MW 700** is compatible with round ducts.



Blaubox EC MW 700

### Blaubox EC ME 300 ... 700

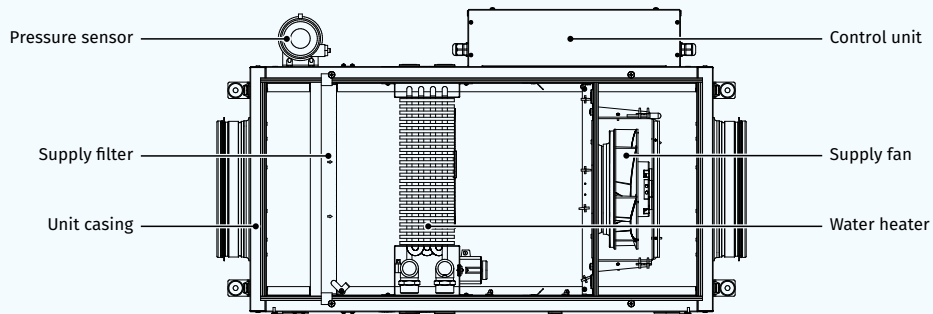

### Blaubox EC ME 1000 ... 4000

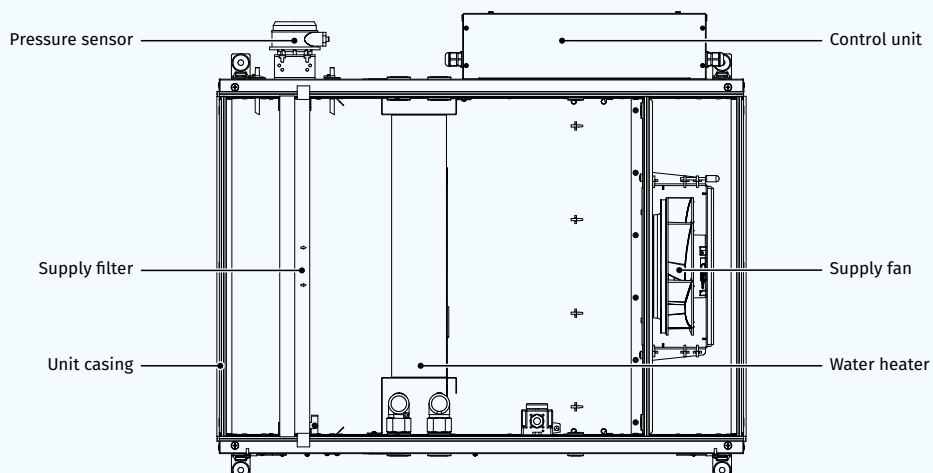



### Fans

- o Efficient external rotor EC-motors and centrifugal impellers with backward curved blades.
- o EC-motors are featured with high performance, low noise level and totally controllable speed range.
- o Dynamically balanced impeller.

### Air filtration

- o Panel Coarse 60% (G4) filter for supply air purification.
- o Panel ePM10 90% (F7) filter is available as an option.

### Air heater

- o The unit is equipped with a water heater.
- o Integrated frost protection.



### Mounting

- o The unit is suitable for indoor mounting on the floor, ceiling mounting or wall mounting with fixing brackets in any mounting position, except for the vertical one with air flow downward.
- o The correctly mounted unit must provide free access to the service panel.

### Control and automation

- o The units are equipped with an S31 integrated automation control system.
- o Remote control panels are not included in the delivery set and ordered separately.

### Automation functions

Functions	Description
Wired control panel	S30 
Wired control panel	S32 
Unit on / off	+
Fan speed control and setting	+
Filter clogging indication and control	Pressure sensor
Week schedule	+
Electric heater protection with auto restart	+
Electric heater protection with manual restart	+
Supply temperature control	+
Outer temperature sensor	+
Water heater frost protection	+
Return temperature sensor	+
Air damper control	+
Alarm indication	+
BMS Connection	ModBUS (RTU)
Humidity sensor	0-10 V or NO
CO <sub>2</sub> Sensor	0-10 V or NO
Exhaust fan control	on / off
Three-way valve control	+
Circulation pump control	+
Condensing unit control	0-10 V

### Designation key

Series	Motor type	Heater type	Rated air flow [m <sup>3</sup> /h]	Service side	Control
Blaubox: supply air unit	EC: electronically commutated motor	MW: water	300; 400; 700; 1000; 1500; 2000; 3000; 4000	L: left R: right	S31

**Overall dimensions [mm]**

Model	∅ D	H	H1	H2	L	L1	L2	L3	W	W1	W2	W3
Blaubox EC MW 700 S31	250	350	218	-	850	903	972	65	460	565	-	-
Blaubox EC MW 1000 S31	-	380	200	250	900	770	65	-	600	653	746	400
Blaubox EC MW 1500 S31	-	440	250	318	900	770	65	-	700	754	847	500
Blaubox EC MW 2000 S31	-	440	300	318	900	770	65	-	700	754	847	500
Blaubox EC MW 3000 S31	-	500	300	368	1200	1070	65	-	800	853	944	600
Blaubox EC MW 4000 S31	-	550	400	380	1200	1070	65	-	940	993	1087	700

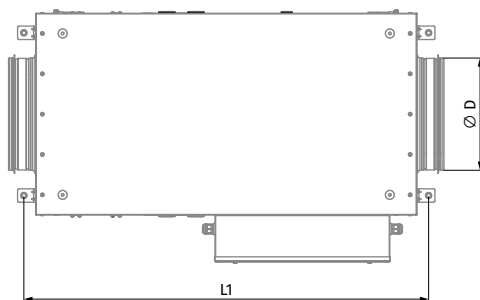
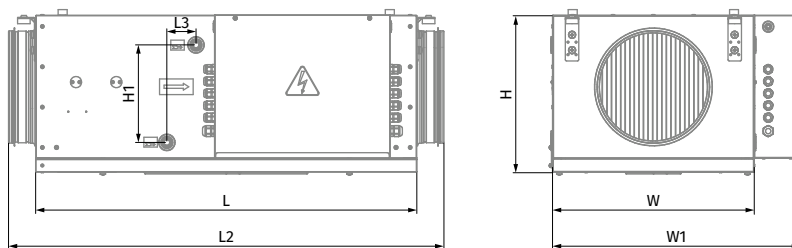

**Blaubox EC MW 700**

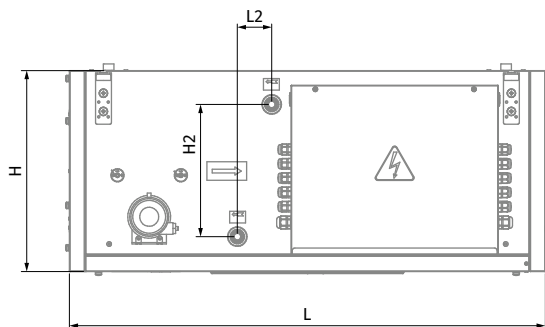
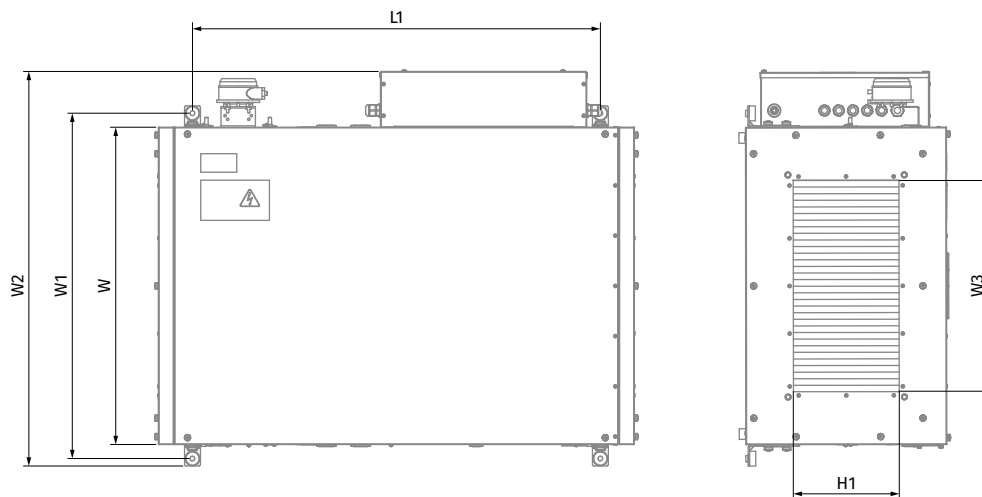

**Blaubox EC MW 1000 – Blaubox EC MW 4000**

**Technical data**

Parameters	Blaubox EC MW 700 S31	Blaubox EC MW 1000 S31
Supply voltage [V / 50 Hz]	1 ~ 230	1 ~ 230
Number of water coil rows	4	4
Water coil connection diameter [in]	3/4	1
Max. unit power [kW]	0.139	0.165
Max. unit current [A]	1.05	1.23
Maximum airflow [m³/h]	800	920
Max. water temperature [°C]	150	150
Sound pressure level at 3 m [dBA]	44	48
Transported air temperature [°C]	-30...+40	-30...+40
Casing material	aluzinc	aluzinc
Insulation	30 mm mineral wool	30 mm mineral wool
Filter	Coarse 90% / G4 (option: ePM1 70% / F7)	Coarse 90% / G4 (option: ePM1 70% / F7)
Connected air duct diameter [mm]	250	400 x 200
Weight [kg]	27	35

**BLAUBOX EC MW 700 S31**

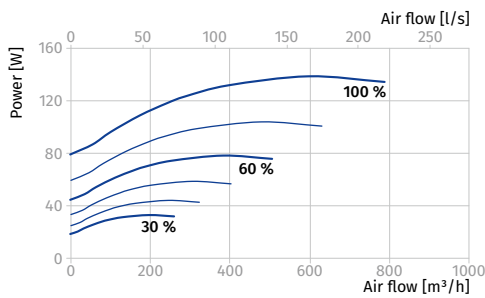
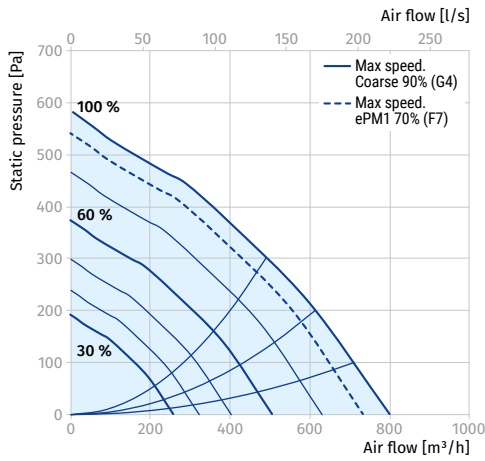

**BLAUBOX EC MW 1000 S31**

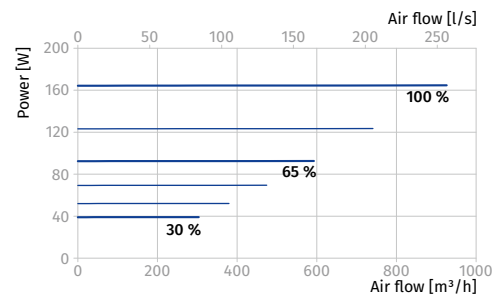
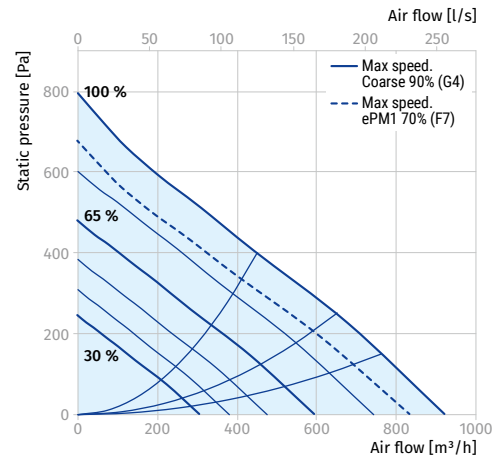

Parameters	Blaubox EC MW 1500 S31	Blaubox EC MW 2000 S31
Supply voltage [V / 50 Hz]	1 ~ 230	1 ~ 230
Number of water coil rows	4	4
Water coil connection diameter [in]	1	1
Max. unit power [kW]	0.222	0.387
Max. unit current [A]	1.6	1.7
Maximum airflow [m³/h]	1445	2150
Max. water temperature [°C]	150	150
Sound pressure level at 3 m [dBA]	49	53
Transported air temperature [°C]	-30...+40	-30...+40
Casing material	aluzinc	aluzinc
Insulation	30 mm mineral wool	30 mm mineral wool
Filter	Coarse 90% / G4 (option: ePM1 70% / F7)	Coarse 90% / G4 (option: ePM1 70% / F7)
Connected air duct diameter [mm]	500 × 250	500 × 300
Weight [kg]	49	45

**BLAUBOX EC MW 1500 S31**

**BLAUBOX EC MW 2000 S31**

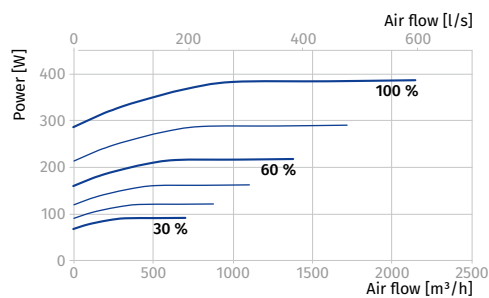
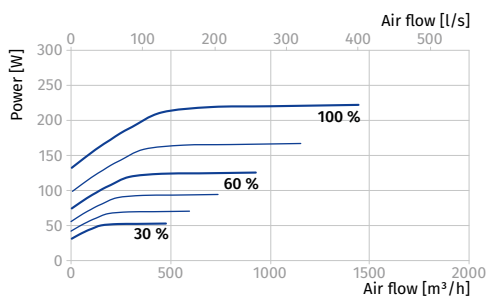
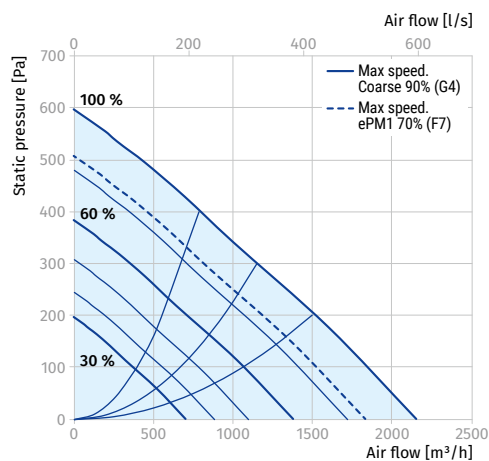
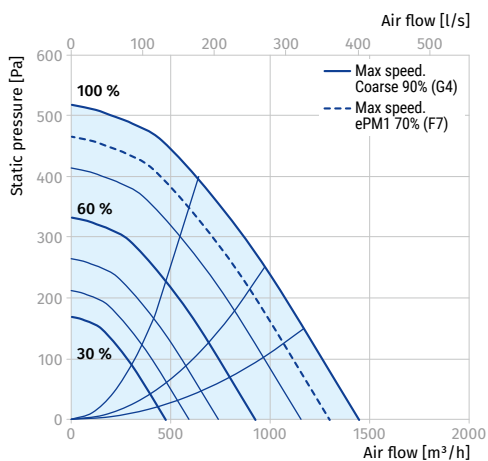

SUPPLY VENTILATION UNITS

Parameters	Blaubox EC MW 3000 S31	Blaubox EC MW 4000 S31
Supply voltage [V / 50 Hz]	1 ~ 230	1 ~ 230
Number of water coil rows	4	4
Water coil connection diameter [in]	1 1/8	1 3/8
Max. unit power [kW]	0.425	0.698
Max. unit current [A]	1.8	1.06
Maximum airflow [m³/h]	2930	4950
Max. water temperature [°C]	150	150
Sound pressure level at 3 m [dBA]	52	54
Transported air temperature [°C]	-30...+40	-30...+40
Casing material	aluzinc	aluzinc
Insulation	30 mm mineral wool	30 mm mineral wool
Filter	Coarse 90% / G4 (option: ePM1 70% / F7)	Coarse 90% / G4 (option: ePM1 70% / F7)
Connected air duct diameter [mm]	600 × 300	700 × 400
Weight [kg]	50	58

**BLAUBOX EC MW 3000 S31**

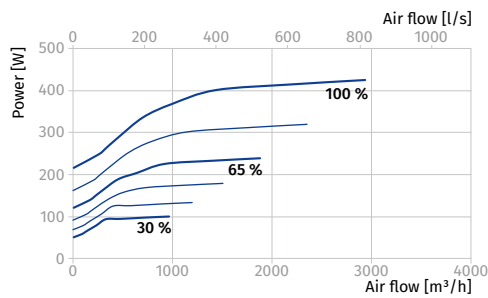
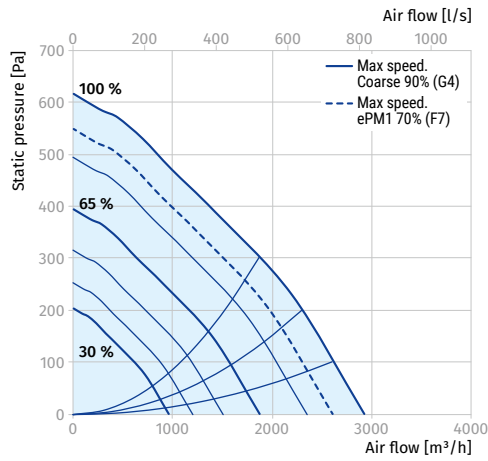

**BLAUBOX EC MW 4000 S31**

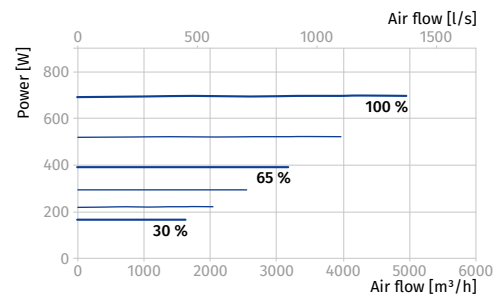
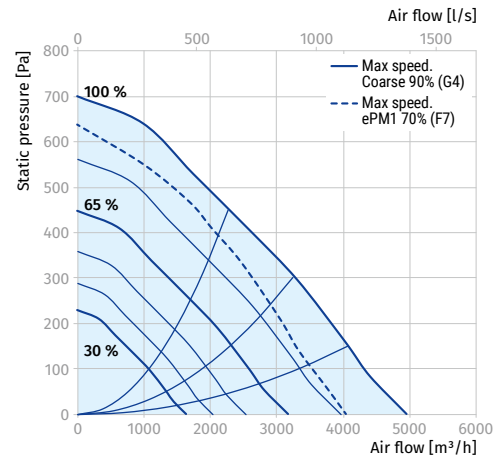

## Hot water coil calculation diagram

### BLAUBOX EC MW 700 S31

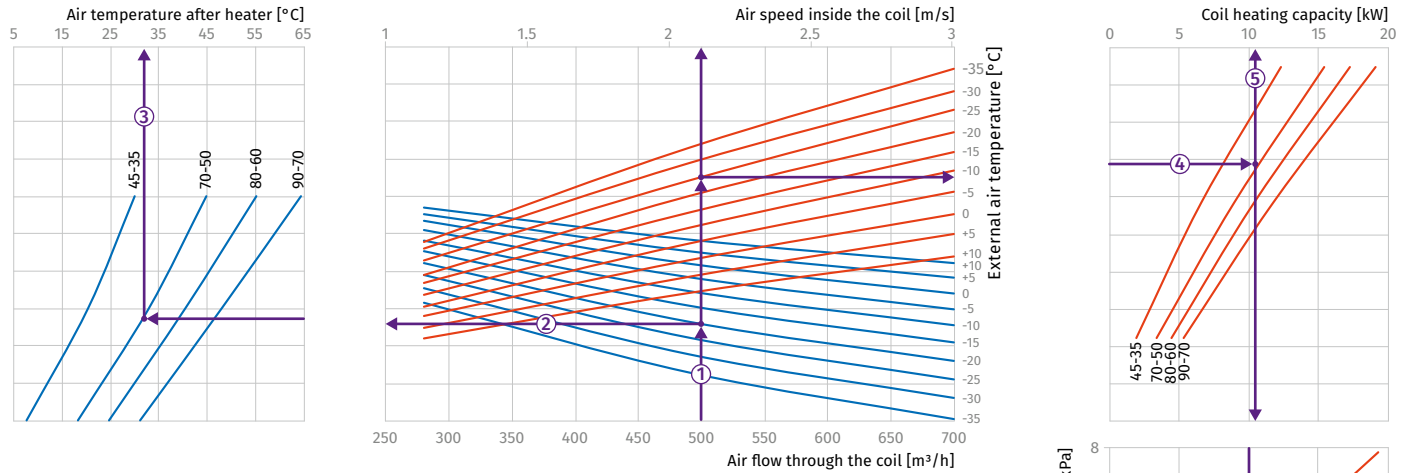

#### How to use water heater diagrams

- Air Speed. Starting from 500 m³/h on the air flow scale draw a vertical line ① till the air speed axis which makes about 2.1 m/s.
- Supply air temperature. Prolong the line ① up to the point where it crosses the outside air temperature (blue curve), e.g. -20 °C; then draw a horizontal line ② from this point to the left till crossing water in/out temperature curve (70/50 °C). From this point draw a vertical line ③ to the supply air temperature axis on top of the graphic (+31 °C).

- Heating coil capacity. Prolong the line ① up to the point where it crosses the outside air temperature -20 °C (red curve) and draw a horizontal line ④ from this point to the right until it crosses water in/out temperature curve (70/50 °C), from here draw a vertical line ⑤ up to the scale representing the heating coil capacity (11 kW).
- Water flow. Prolong the line ⑤ down to water flow axis at the bottom of the graphic ⑥ (600 kg/h).
- Water pressure drop. Draw the line ⑦ from the point where line ⑥ crosses the black curve to the pressure drop axis. (3 kPa).

### BLAUBOX EC MW 1000 S31

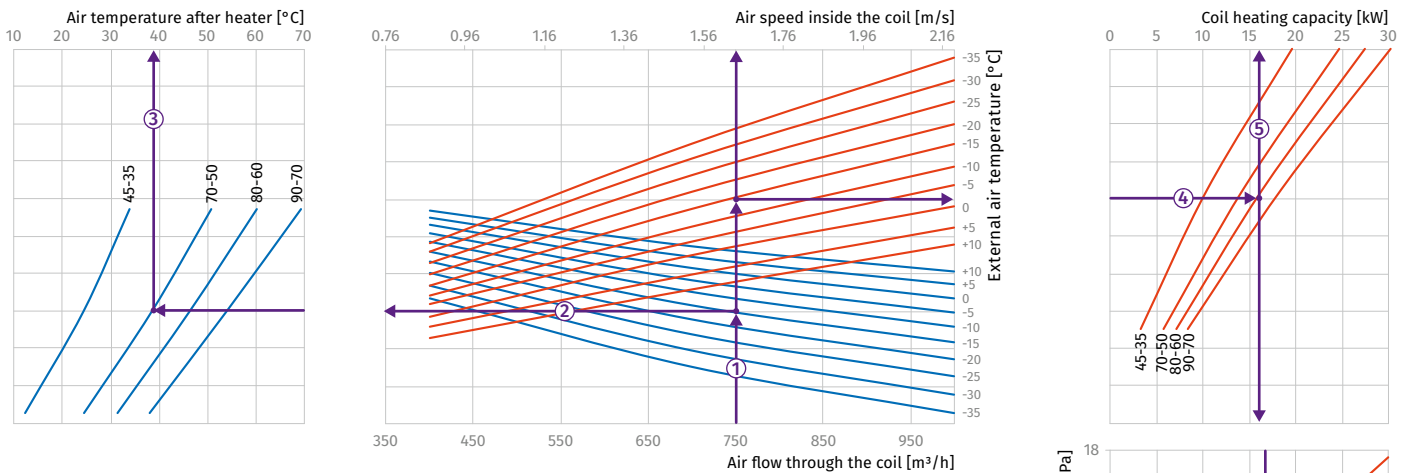

#### How to use water heater diagrams

- Air Speed. Starting from 750 m³/h on the air flow scale draw a vertical line ① till the air speed axis which makes about 1.6 m/s.
- Supply air temperature. Prolong the line ① up to the point where it crosses the outside air temperature (blue curve), e.g. -15 °C; then draw a horizontal line ② from this point to the left till crossing water in/out temperature curve (70/50 °C). From this point draw a vertical line ③ to the supply air temperature axis on top of the graphic (+39 °C).

- Heating coil capacity. Prolong the line ① up to the point where it crosses the outside air temperature -15 °C (red curve) and draw a horizontal line ④ from this point to the right until it crosses water in/out temperature curve (70/50 °C), from here draw a vertical line ⑤ up to the scale representing the heating coil capacity (16 kW).
- Water flow. Prolong the line ⑤ down to water flow axis at the bottom of the graphic ⑥ (1000 kg/h).
- Water pressure drop. Draw the line ⑦ from the point where line ⑥ crosses the black curve to the pressure drop axis. (6 kPa).

### BLAUBOX EC MW 1500 S31

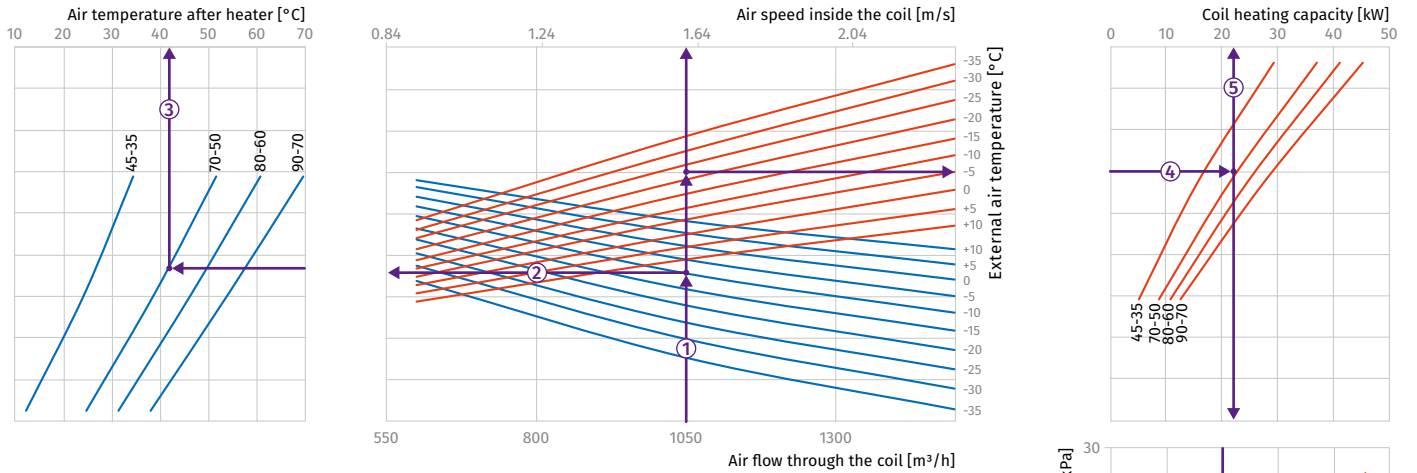

#### How to use water heater diagrams

- Air Speed. Starting from 1050 m³/h on the air flow scale draw a vertical line ① till the air speed axis which makes about 1.6 m/s.
- Supply air temperature. Prolong the line ① up to the point where it crosses the outside air temperature (blue curve), e.g. -10 °C; then draw a horizontal line ② from this point to the left till crossing water in/out temperature curve (70/50 °C). From this point draw a vertical line ③ to the supply air temperature axis on top of the graphic (+41 °C).

- Heating coil capacity. Prolong the line ① up to the point where it crosses the outside air temperature -15 °C (red curve) and draw a horizontal line ④ from this point to the right until it crosses water in/out temperature curve (70/50 °C), from here draw a vertical line ⑤ up to the scale representing the heating coil capacity (22 kW).
- Water flow. Prolong the line ⑤ down to water flow axis at the bottom of the graphic ⑥ (1220 kg/h).
- Water pressure drop. Draw the line ⑦ from the point where line ⑥ crosses the black curve to the pressure drop axis. (8.5 kPa).

### BLAUBOX EC MW 2000 S31

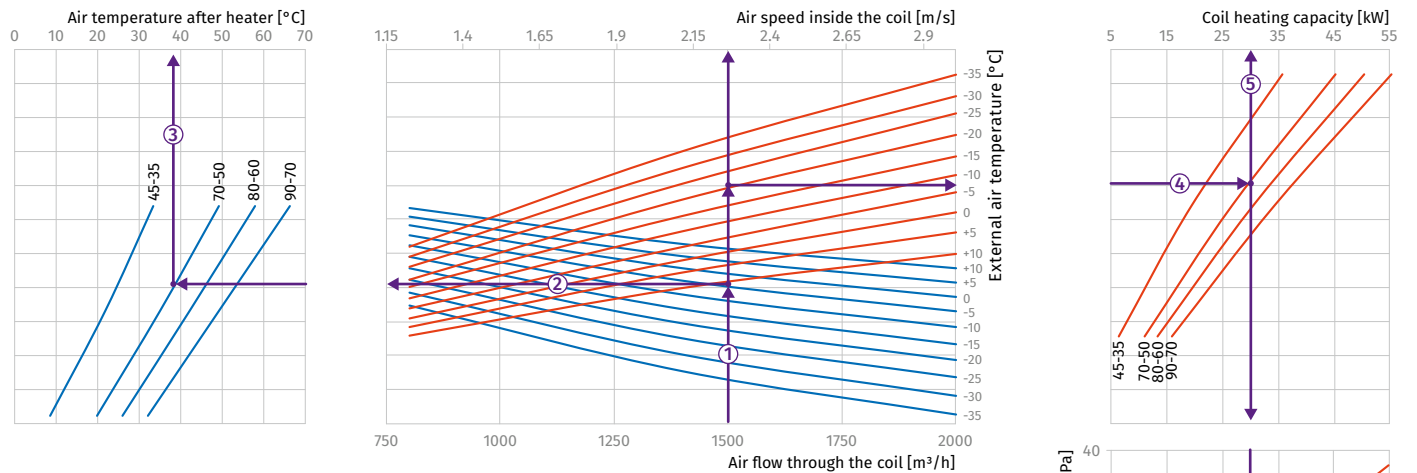

#### How to use water heater diagrams

- Air Speed. Starting from 1500 m³/h on the air flow scale draw a vertical line ① till the air speed axis which makes about 2.25 m/s.
- Supply air temperature. Prolong the line ① up to the point where it crosses the outside air temperature (blue curve), e.g. -5 °C; then draw a horizontal line ② from this point to the left till crossing water in/out temperature curve (70/50 °C). From this point draw a vertical line ③ to the supply air temperature axis on top of the graphic (+38 °C).

- Heating coil capacity. Prolong the line ① up to the point where it crosses the outside air temperature -15 °C (red curve) and draw a horizontal line ④ from this point to the right until it crosses water in/out temperature curve (70/50 °C), from here draw a vertical line ⑤ up to the scale representing the heating coil capacity (30 kW).
- Water flow. Prolong the line ⑤ down to water flow axis at the bottom of the graphic ⑥ (1750 kg/h).
- Water pressure drop. Draw the line ⑦ from the point where line ⑥ crosses the black curve to the pressure drop axis. (15 kPa).

**BLAUBOX EC MW 3000 S31**

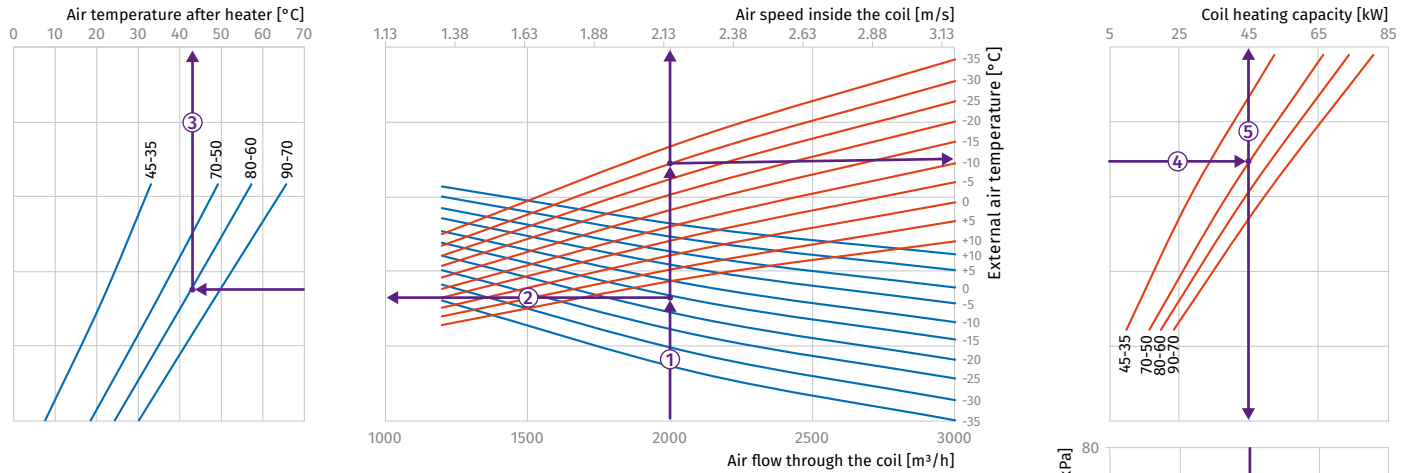

**How to use water heater diagrams**

- Air Speed. Starting from 2000 m<sup>3</sup>/h on the air flow scale draw a vertical line ① till the air speed axis which makes about 2.2 m/s.
- Supply air temperature. Prolong the line ① up to the point where it crosses the outside air temperature (blue curve), e.g. -15 °C; then draw a horizontal line ② from this point to the left till crossing water in/out temperature curve (80/60 °C). From this point draw a vertical line ③ to the supply air temperature axis on top of the graphic (+43 °C).

- Heating coil capacity. Prolong the line ① up to the point where it crosses the outside air temperature -15 °C (red curve) and draw a horizontal line ④ from this point to the right until it crosses water in/out temperature curve (70/50 °C), from here draw a vertical line ⑤ up to the scale representing the heating coil capacity (45 kW).
- Water flow. Prolong the line ⑤ down to water flow axis at the bottom of the graphic ⑥ (2650 kg/h).
- Water pressure drop. Draw the line ⑦ from the point where line ⑥ crosses the black curve to the pressure drop axis. (24 kPa).

**BLAUBOX EC MW 4000 S31**

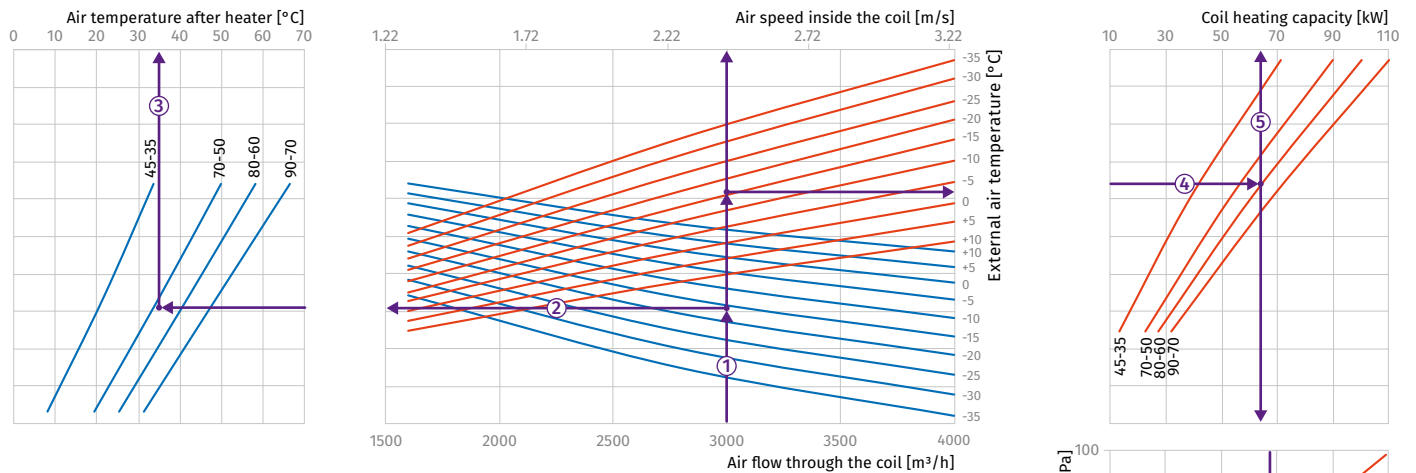





**How to use water heater diagrams**

- Air Speed. Starting from 3000 m<sup>3</sup>/h on the air flow scale draw a vertical line ① till the air speed axis which makes about 2.5 m/s.
- Supply air temperature. Prolong the line ① up to the point where it crosses the outside air temperature (blue curve), e.g. -15 °C; then draw a horizontal line ② from this point to the left till crossing water in/out temperature curve (70/50 °C). From this point draw a vertical line ③ to the supply air temperature axis on top of the graphic (+35 °C).

- Heating coil capacity. Prolong the line ① up to the point where it crosses the outside air temperature -20 °C (red curve) and draw a horizontal line ④ from this point to the right until it crosses water in/out temperature curve (80/60 °C), from here draw a vertical line ⑤ up to the scale representing the heating coil capacity (65 kW).
- Water flow. Prolong the line ⑤ down to water flow axis at the bottom of the graphic ⑥ (4100 kg/h).
- Water pressure drop. Draw the line ⑦ from the point where line ⑥ crosses the black curve to the pressure drop axis. (45 kPa).



**Accessories**

		Blaubox EC MW 700	Blaubox EC MW 1000	Blaubox EC MW 1500	Blaubox EC MW 2000	Blaubox EC MW 3000	Blaubox EC MW 4000
<b>Panel filter G4</b>		FP 384x287x48 Coarse 90% / G4	FP 536x316x48 Coarse 90% / G4	FP 636x376x48 Coarse 90% / G4	FP 636x376x48 Coarse 90% / G4	FP 734x435x80 Coarse 90% / G4	FP 874x485x80 Coarse 90% / G4
<b>Panel filter F7</b>		FP 384x287x48 ePM1 70% / F7	FP 536x316x48 ePM1 70% / F7	FP 636x376x48 ePM1 70% / F7	FP 636x376x48 ePM1 70% / F7	FP 384x287x48 ePM1 70% / F7	FP 874x485x80 ePM1 70% / F7
<b>Flexible anti-vibration connector</b>		EVA 250	EVA 40x20	EVA 50x25	EVA 50x30	EVA 60x30	EVA 70x40
<b>Silencer</b>		SD 250	SD 40x20	SD 50x25	SD 50x30	SD 60x30	SD 70x40
<b>Air damper</b>		VKA 250	SL 40x20	SL 50x25	SL 50x30	SL 60x30	SL 70x40
<b>Air damper electric actuator</b>		TF230 / TF24	TF230 / TF24	TF230 / TF24	TF230 / TF24	TF230 / TF24	TF230 / TF24

# BLAUBOX DE PRO

## Supply suspended ventilation units

### Features

- Ventilation units for efficient supply ventilation in various premises.
- Controllable air supply, heating and filtration.
- Compatible with 400x200, 500x300 and 600x350 mm rectangular air ducts.



**Air flow:**  
up to 3350 m<sup>3</sup>/h  
931 l/s



### Design

- The casing is made of double-skinned aluzinc panels, internally filled with 50 mm mineral wool layer for heat and sound insulation.
- The casing has fixing brackets with vibration absorbing connectors for easy installation.
- The hinged casing panel ensures easy access to the internals for cleaning, filter replacement and other maintenance operations.

### Fans

- Asynchronous external rotor motor and centrifugal high-pressure impeller with backward curved blades is used for air supply.
- Integrated motor overheating protection with automatic restart.
- Dynamically balanced impeller.
- Equipped with ball bearings for longer service life.
- Reliable and quiet operation.

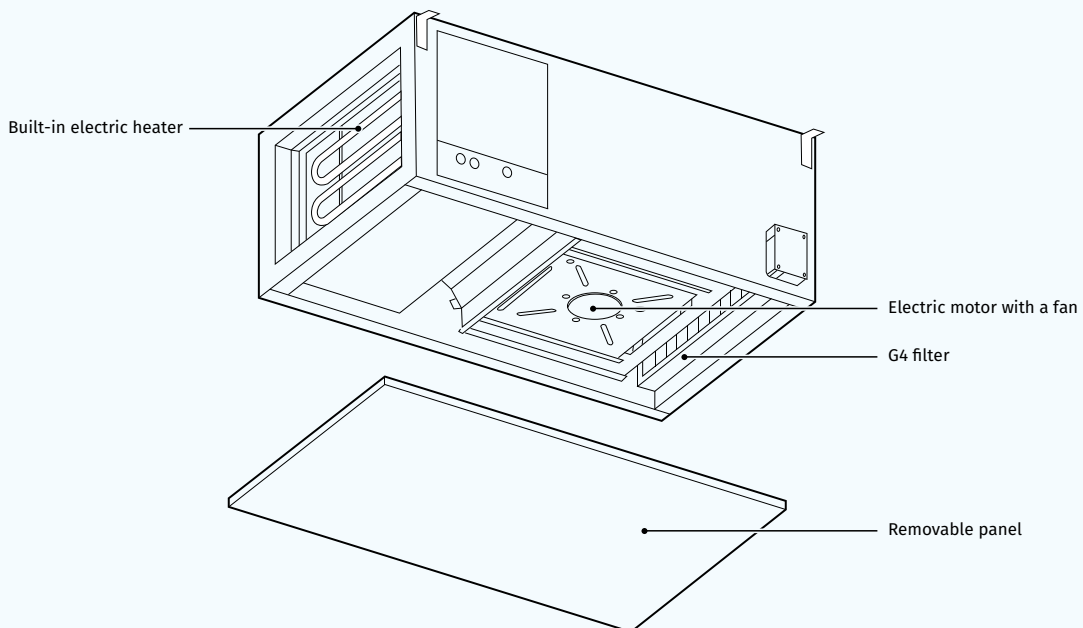

### Air heater

- The units are equipped with an electric heater for operation during cold seasons at low outside temperature.
- Two integrated overheat protection thermostats, one actuated at +60 °C with automatic restart and the other one actuated at +90 °C with manual restart.

### Air filtration

- The built-in G4 supply filter provides air filtration.

### Control and automation

- The units incorporate an integrated control system with a wall-mounted control panel and LCD display.
- The standard delivery set includes a 10 m cable for connection of the unit and the control panel.
- **Control panel functions:**
  - Activating/deactivating the unit.
  - Setting low, medium and high speeds for the supply fan. Air flow control.
  - Supply air setting and maintaining.
  - Display of indoor air temperature.
  - Display of errors (alarms) and filter replacement indication.
  - Setting or week-scheduled operation of the unit.

### Automation functions:

- Overheating protection of the electric heating elements.
- Disabling heater activation during the fan shutoff.
- Filter clogging control with a pressostat.
- All the operation parameters are individually adjustable.

### Mounting

- The unit is suitable for mounting on the floor, ceiling mounting or wall mounting with fixing brackets in any mounting position except for the vertical one with air flow downward.
- Wiring via the terminal block in the terminal box.
- The correctly mounted unit must provide free access to the hinged panel for servicing and filter replacement.

### Designation key

Series	Casing modification	Heater type	Rated air flow [m³/h]	Electric heater power [kW]	Control
BLAUBOX	D: Suspended mounting	E: electric heater	1300; 2500; 3300	– 12; 18; 21	Pro: with control panel

### Overall dimensions [mm]

Model	B	B1	B2	B3	H	H1	H2	L	L1
BLAUBOX DE 1300-12 Pro	400	420	624	582	200	220	374	1145	1106
BLAUBOX DE 2500-18 Pro	500	520	689	646	300	320	447	1250	1212
BLAUBOX DE 3300-21 Pro	600	620	888	744	350	370	500	1252	1212

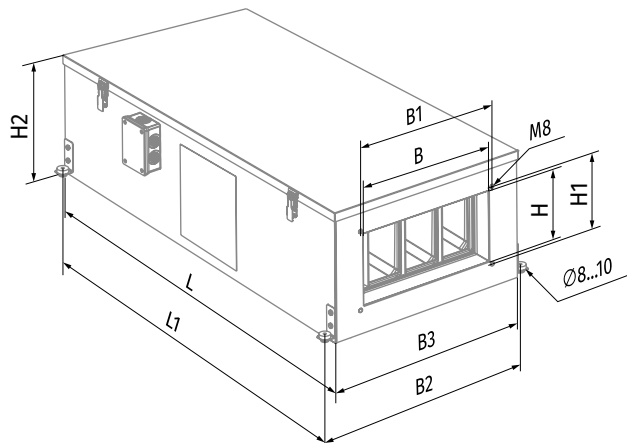

## Technical data

Parameters	BLAUBOX DE 1300-12 Pro	BLAUBOX DE 2500-18 Pro	BLAUBOX DE 3300-21 Pro
Voltage [V / 50 Hz]	3 ~ 400	3 ~ 400	3 ~ 400
Power [kW]	0.32	0.62	1.33
Current [A]	0.55	1.05	2.4
Electric heater power [kW]	12.0	18.0	21.0
Electric heater current [A]	17.4	26.0	30.0
Unit power [kW]	12.32	18.62	22.33
Unit current [A]	17.95	27.05	32.4
Maximum air flow [m <sup>3</sup> /h (l/s)]	1275 (354)	2500 (695)	3350 (931)
Sound pressure level at 3 m [dBA]	51	54	57
Transported air temperature [°C]	-25...+40	-25...+40	-25...+40
Casing material	aluzinc	aluzinc	aluzinc
Insulation	50 mm mineral wool	50 mm mineral wool	50 mm mineral wool
Filter	G4	G4	G4
Connected air duct diameter [mm]	400x200	500x300	600x350
Weight [kg]	56	61	91
ErP	2016, 2018	2016, 2018	2016, 2018

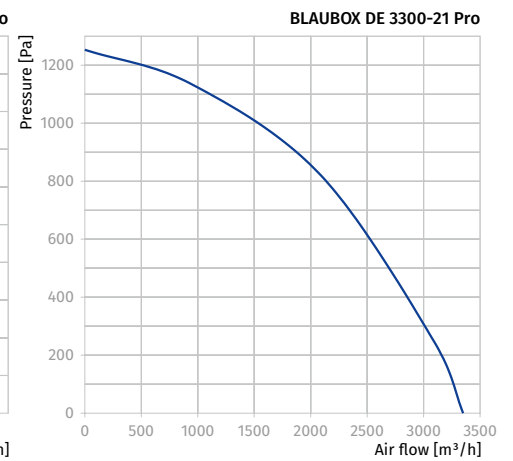
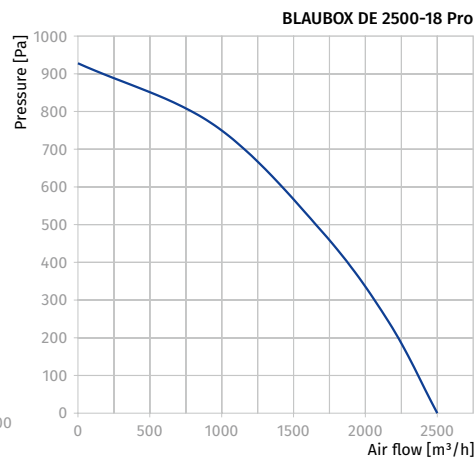
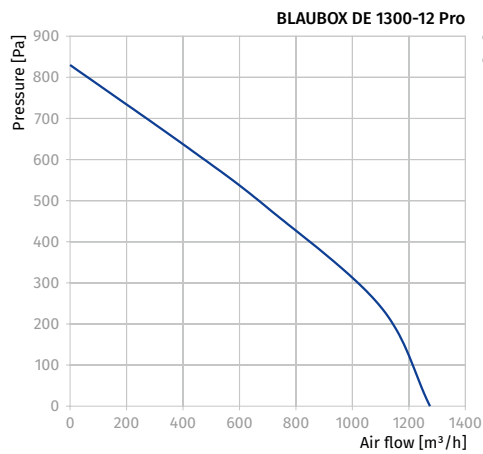

## Accessories

		BLAUBOX DE 1300-12 Pro	BLAUBOX DE 2500-18 Pro	BLAUBOX DE 3300-21 Pro
G4 panel filter		FP 442x275x47 G4	FP 442x275x47 G4	FP 545x390x47 G4
Silencer		SD 40x20	SD 50x30	SD 60x35
Duct cooling unit		KFK 40x20-3	KFK 50x30-3	KFK 60x35-3
Duct cooling unit		KWK 40x20-3	KWK 50x30-3	KWK 60x35-3
Air flow dampers		SL 40x20	SL 50x30	SL 560x35
Flexible anti-vibration connector		EVA 40x20	EVA 50x30	EVA 60x35
Air damper electric actuator		TF230	TF230	TF230

# BLAUBOX DW PRO

## Supply suspended ventilation units

### Features

- Ventilation units for efficient supply ventilation in various premises.
- Controllable air supply, heating and filtration.
- Compatible with 400x200 up to 700x400 mm rectangular air ducts.



**Air flow:**  
up to 3260 m<sup>3</sup>/h  
906 l/s



### Design

- The casing is made of double-skinned aluzinc panels, internally filled with 50 mm mineral wool layer for heat and sound insulation.
- The casing has fixing brackets with vibration absorbing connectors for easy installation.
- The hinged casing panel ensures easy access to the internals for cleaning, filter replacement and other maintenance operations.

### Fans

- Asynchronous external rotor motor and centrifugal high-pressure impeller with backward curved blades is used for air supply.
- Integrated motor overheating protection with automatic restart.
- Dynamically balanced impeller.
- Equipped with ball bearings for longer service life.
- Reliable and quiet operation.

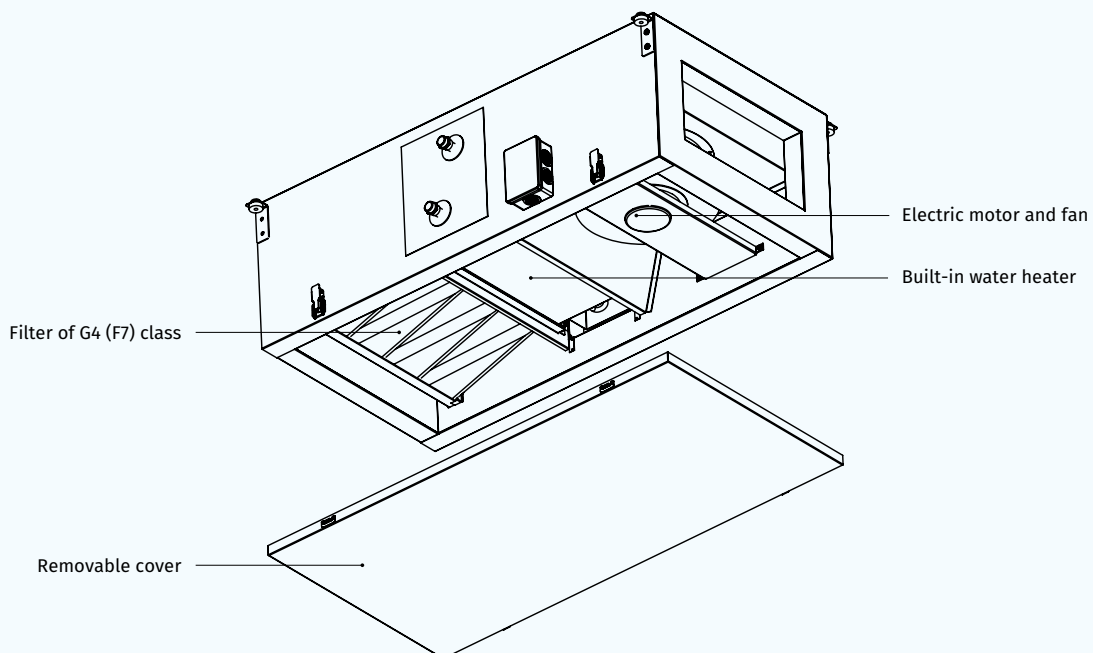

### Air heater

- The units are equipped with a water (glycol) heater for operation during cold seasons at low outside temperature.
- The air temperature sensor downstream of the water heater and the return heat medium sensor ensure freezing protection of the water heater. If any of these sensors detects a temperature point below the set minimum value, the signal is sent automatically to the control unit to troubleshoot cooling.

### Air filtration

- The built-in G4 supply filter provides air filtration.
- Optionally a F7 filter may be installed for efficient filtration.

### Control and automation

- The units incorporate an integrated control system with a wall-mounted control panel and LCD display.
- The standard delivery set includes a 10 m cable for connection of the unit and the control panel.
- **Control panel functions:**
  - Activating/deactivating the unit.
  - Setting low, medium and high speeds for the supply fan. Air flow control.
  - Setting and maintaining of indoor air temperature.
  - Display of the indoor air temperature.
  - Supply filter clogging control according to the pressostat.
  - Alarm indication.

### Automation functions:

- Control of the supply air damper actuator (separate order).
- Smooth rotation speed control of the fan (3 ~ 400 V, 50 Hz).
- Water heater control.
- Generation of the activation signal for the exhaust fan if available in the system.
- Shutdown of the unit on signal from the fire alarm panel.
- Control of the cooler with respect to the set indoor air temperature (separate order).
- All the operation parameters are individually adjustable.

### Mounting

- The unit is suitable for mounting on the floor, ceiling mounting or wall mounting with fixing brackets in any mounting position except for the vertical one with air flow downward.
- The correctly mounted unit must provide free access to the hinged panel for servicing and filter replacement.

### Designation key

Series	Casing modification	Heater type	Rated air flow [m³/h]	Number of water coil rows	Control
BLAUBOX	D: Suspended mounting	W: water heater	1200; 2300; 3200	– 3; 4	Pro: with control panel

### Overall dimensions [mm]

Model	B	B1	B2	B3	H	H1	H2	L	L1
BLAUBOX DW 1200-4 Pro	400	420	624	582	200	220	374	1145	1106
BLAUBOX DW 2300-4 Pro	500	520	689	646	300	320	447	1250	1212
BLAUBOX DW 3200-4 Pro	600	620	787	744	350	370	500	1252	1212

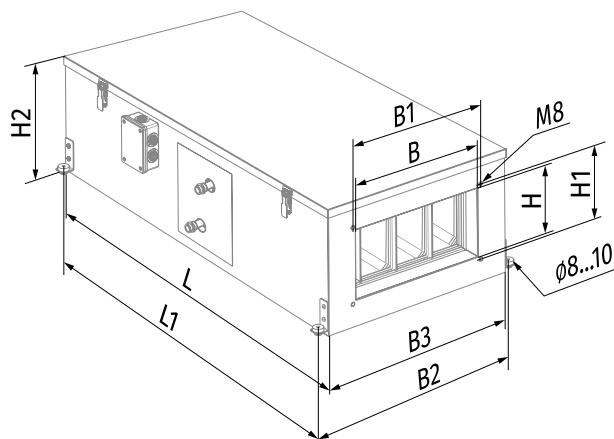

## Technical data

Parameters	BLAUBOX DW 1200-4 Pro	BLAUBOX DW 2300-4 Pro	BLAUBOX DW 3200-4 Pro
Voltage [V / 50 Hz]	3 ~ 400	3 ~ 400	3 ~ 400
Number of water (glycol) coil rows	4	4	4
Power [kW]	0.32	0.62	1.33
Current [A]	0.55	1.05	2.4
Maximum air flow [m <sup>3</sup> /h (l/s)]	1200 (333)	2350 (653)	3260 (906)
Sound pressure level at 3 m [dBA]	51	54	57
Transported air temperature [°C]	-25...+40	-25...+40	-25...+40
Casing material	aluzinc	aluzinc	aluzinc
Insulation	50 mm mineral wool	50 mm mineral wool	50 mm mineral wool
Supply filter	G4 (option: F7)	G4 (option: F7)	G4 (option: F7)
Connected air duct diameter [mm]	400x200	500x300	600x350
Weight [kg]	57	63	94
ErP	2016, 2018	2016, 2018	2016, 2018

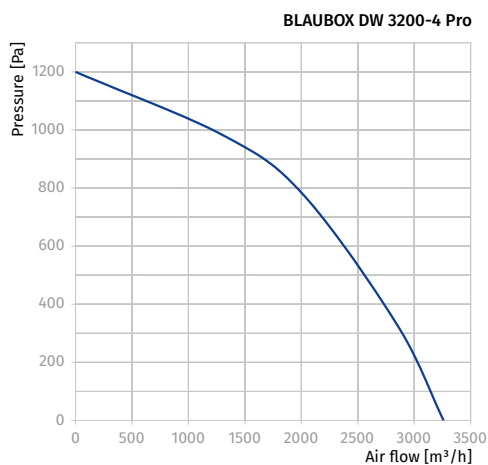
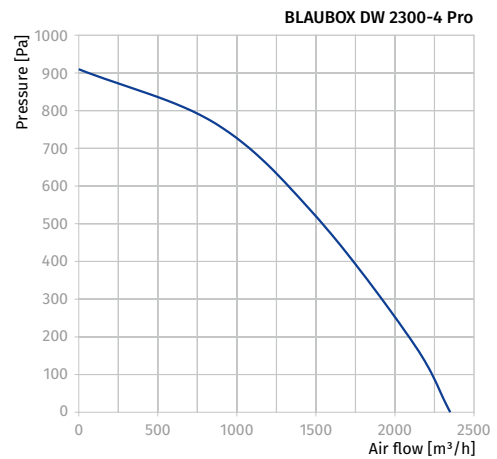
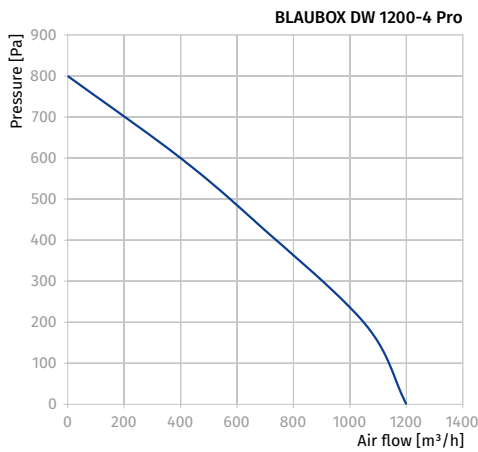



### BLAUBOX DW 1200-4 PRO

Air temperature downstream of the water heating coils [°C]

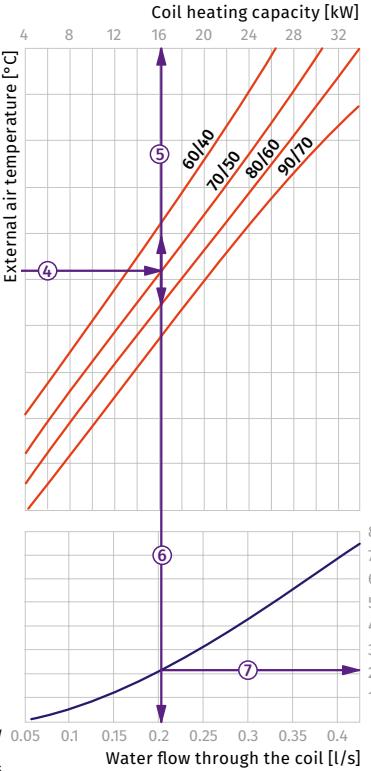
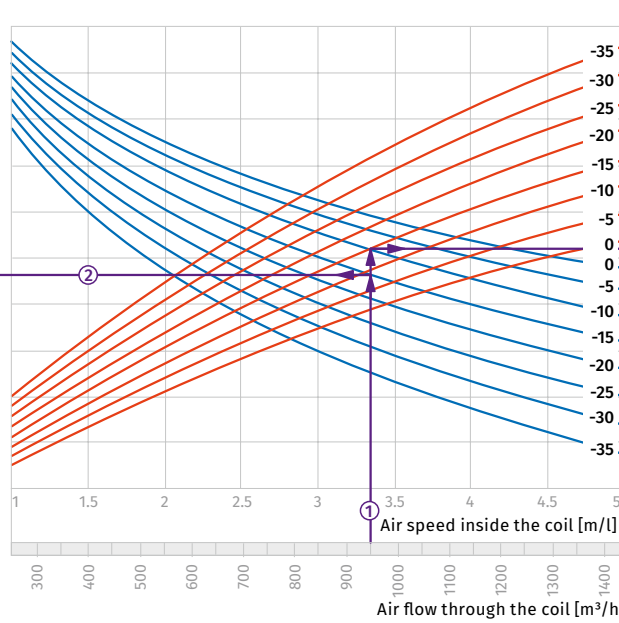
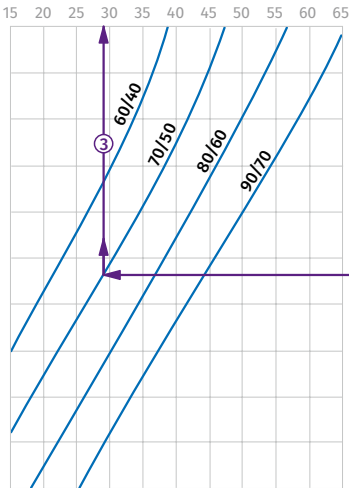

**How to use water heater diagrams.**

The air flow is 350 m<sup>3</sup>/h and the air speed in the cooling unit is 3.35 m/s ①.

- To calculate the maximum air temperature find the intersection point of the air flow line ① with the rated outer temperature shown in blue line (e.g., -15 °C) and draw the line ② to the left until it crosses the water in/out temperature curve (e.g. +70/+50). From this point draw a vertical line to the supply air temperature downstream of the heater (+29 °C) ③.
- To calculate the heater power find the intersection point of the air flow ① with the rated winter temperature shown in red line (e.g., -15 °C) and draw the line ④ to the right until it crosses the

- water in/out temperature curve (e.g. +70/+50). From this point draw a vertical line to the heater power axis (16.0 kW) ⑤.
- To calculate the required water flow in the heater prolong this line ⑥ downwards to the water flow axis (0.2 l/s).
- To calculate the water pressure drop in the heater find the intersection point of the line ⑥ with the pressure loss curve and prolong the line ⑦ to the right on the water pressure drop axis (2.1 kPa).

### BLAUBOX DW 2300-4 PRO

Air temperature downstream of the water heating coils [°C]

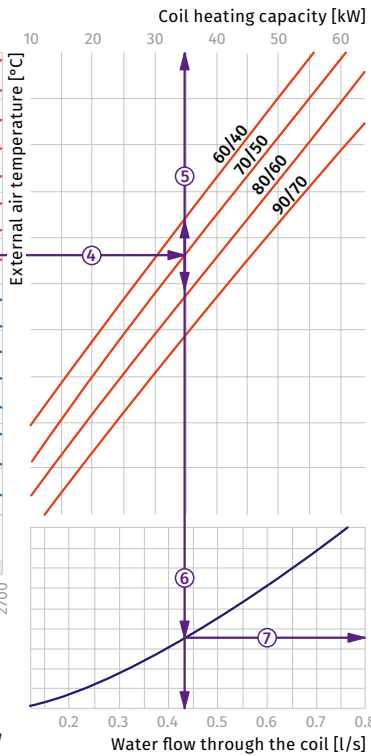
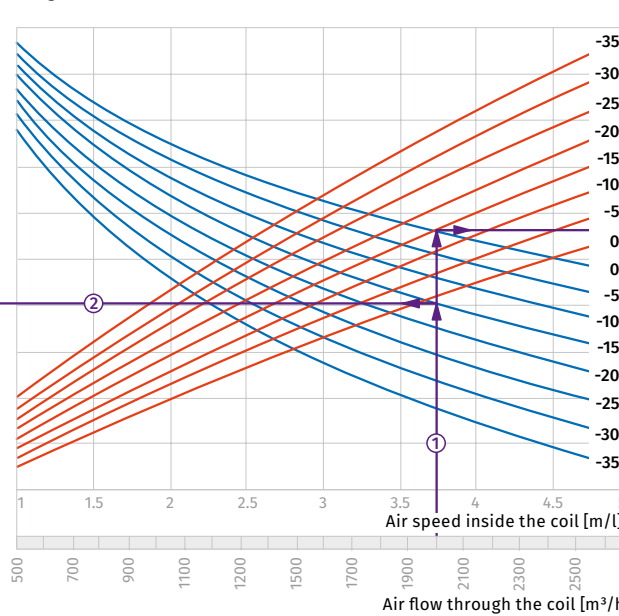
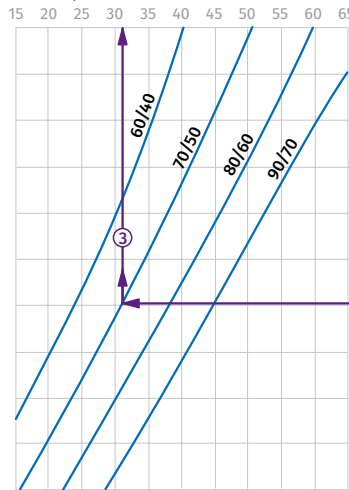

**How to use water heater diagrams.**

The air flow is 2000 m<sup>3</sup>/h and the air speed in the cooling unit is 3.75 m/s ①.

- To calculate the maximum air temperature find the intersection point of the air flow line ① with the rated outer temperature shown in blue line (e.g., -15 °C) and draw the line ② to the left until it crosses the water in/out temperature curve (e.g. +70/+50). From this point draw a vertical line to the supply air temperature downstream of the heater (+31 °C) ③.
- To calculate the heater power find the intersection point of the air flow ① with the rated winter temperature shown in red line (e.g., -15 °C) and draw the line ④ to the right until it crosses the

- water in/out temperature curve (e.g. +70/+50). From this point draw a vertical line to the heater power axis (35.0 kW) ⑤.
- To calculate the required water flow in the heater prolong this line ⑥ downwards to the water flow axis (0.43 l/s).
- To calculate the water pressure drop in the heater find the intersection point of the line ⑥ with the pressure loss curve and prolong the line ⑦ to the right on the water pressure drop axis (9.0 kPa).

**BLAUBOX DW 3200-4 PRO**

Air temperature downstream of the water heating coils [°C]

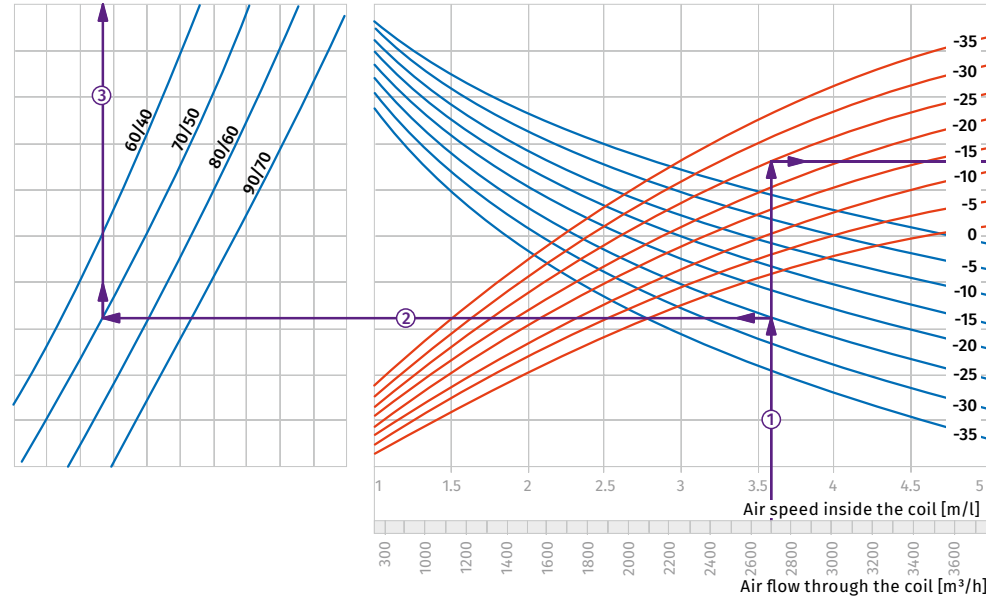

**How to use water heater diagrams.**

The air flow is 2700 m<sup>3</sup>/h and the air speed in the cooling unit is 3.59 m/s ①.

- To calculate the maximum air temperature find the intersection point of the air flow line ① with the rated outer temperature shown in blue line (e.g., -25 °C) and draw the line ② to the left until it crosses the water in/out temperature curve (e.g. +70/+50). From this point draw a vertical line to the supply air temperature downstream of the heater (+28 °C) ③.
- To calculate the heater power find the intersection point of the air flow ① with the rated winter temperature shown in red line (e.g., -25 °C) and draw the line ④ to the right until it crosses the

- water in/out temperature curve (e.g. +70/+50). From this point draw a vertical line to the heater power axis (58.0 kW) ⑤.
- To calculate the required water flow in the heater prolong this line ⑤ downwards to the water flow axis (0.73 l/s).
- To calculate the water pressure drop in the heater find the intersection point of the line ⑥ with the pressure loss curve and prolong the line ⑦ to the right on the water pressure drop axis (14.0 kPa).

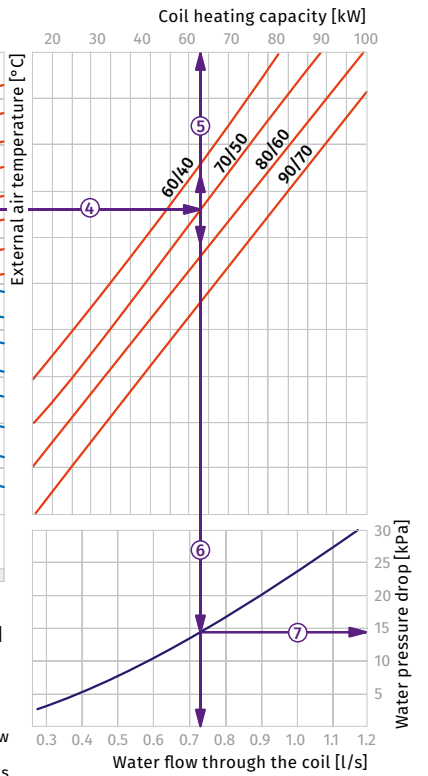

**Accessories**

		BLAUBOX DW 1200-4 Pro	BLAUBOX DW 2300-4 Pro	BLAUBOX DW 3200-4 Pro
G4 pocket filter		FPT 538x342x27 G4	FPT 538x342x27 G4	FPT 637x395x27 G4
Silencer		SD 40x20	SD 50x30	SD 60x35
Duct cooling unit		KFK 40x20-3	KFK 50x30-3	KFK 60x35-3
Duct cooling unit		KWK 40x20-3	KWK 50x30-3	KWK 60x35-3
Water mixing unit		WMG	WMG	WMG
Air flow dampers		SL 40x20	SL 50x30	SL 60x35
Flexible anti-vibration connector		EVA 40x20	EVA 50x30	EVA 60x35
Air damper electric actuator		TF230	TF230	TF230

# EVH S21 V.2

## Electric duct preheater for heat exchanger freeze protection

### Features

- Heat exchanger freeze protection by means of preheating of the intake air.
- Maintains the duct air temperature at a point that prevents the heat exchanger freezing.
- Compatible with  $\varnothing$  125 up to 315 mm air ducts.



### Design

- The casing is internally filled with 20 mm layer of non-flammable mineral wool.
- The casing and the junction box are made of galvanized steel.
- Heating elements are made of stainless steel.
- Airtight connection to air ducts due to rubber seals.

### Control

- Equipped with a power cable.
- The signal cable for connection to the controller of the air handling unit.
- Equipped with a triac power regulator. Regulation is carried out via switching-on and switching-off the full load. Load commutation is carried out by the semiconductor device (triac). The switching unit has no wearing mechanical elements.
- Equipped with overheat thermostats:**
  - main protection with automatic restart at +60 °C;
  - emergency protection with manual restart at +90 °C.

### Mounting

- Fixation to round air ducts by means of clamp (included in the delivery)
- The heater is controlled by the air handling unit through the cable supplied and connected to the heater at the factory.
- In case of horizontal mounting position the control box cover must be directed upwards only. Permitted deviation up to 90°. The control box cover may not be positioned downwards!

### Compatibility chart

Heater model	Unit model
EVH 125 S21 V.2	KOMFORT EC SB unit with a $\varnothing$ 125 pipe and an S21 automation without a DB-9M connector
EVH 150 S21 V.2	KOMFORT EC SB unit with a $\varnothing$ 150 pipe and an S21 automation without a DB-9M connector
EVH 160 S21 V.2	KOMFORT EC SB unit with a $\varnothing$ 160 pipe and an S21 automation without a DB-9M connector
EVH 200 S21 V.2	KOMFORT EC SB unit with a $\varnothing$ 200 pipe and an S21 automation without a DB-9M connector
EVH 250 S21 V.2	KOMFORT EC SB unit with a $\varnothing$ 250 pipe and an S21 automation without a DB-9M connector
EVH 315 S21 V.2	BlauAIR unit with a $\varnothing$ 315 pipe and an S21 automation without a DB-9M connector

### Overall dimensions [mm]

Model	$\varnothing$ D	B	H	L	L1
EVH 125-0.6-1	125	164	249	306	192
EVH 125-0.8-1	125	164	249	306	192
EVH 125-1.2-1	125	164	249	306	192
EVH 150-0.8-1	150	189	280	306	192
EVH 150-1.2-1	150	189	280	306	192
EVH 150-1.7-1	150	189	280	306	192
EVH 150-2.0-1	150	189	280	306	192
EVH 160-0.8-1	160	197	291	306	192
EVH 160-1.2-1	160	197	291	306	192
EVH 160-1.7-1	160	197	291	306	192
EVH 160-2.0-1	160	197	291	306	192
EVH 200-1.2-1	200	239	336	306	192
EVH 200-1.7-1	200	239	336	306	192
EVH 200-2.0-1	200	239	336	306	192
EVH 250-1.2-1	250	287	388	307	192
EVH 250-2.0-1	250	287	388	307	192
EVH 250-3.0-1	250	287	388	307	192
EVH 315-2.0-1	315	353	454	306	192
EVH 315-3.0-1	315	353	454	306	192

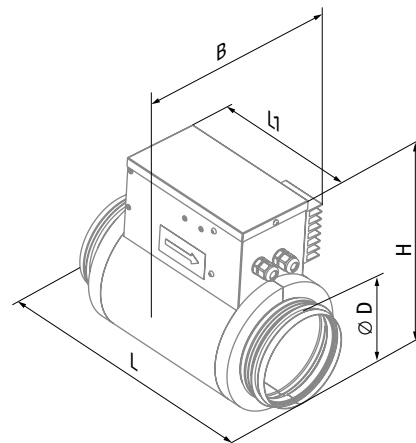

### Designation key

Series	Connected air duct diameter [mm]	Heater power [kW]	Number of phases	Compatibility with automation
EVH	125; 150; 160; 200; 250; 315	0.6; 0.8; 1.2; 1.7; 2.0; 3.0	1: single-phase	S21 V.2: compatible with an S21 automation without a DB-9M connector

### Technical data

Parameters	Min. air flow [m³/h (l/s)]	Power [kW]	Current [A]
EVH 125-0.6-1	60 (17)	0.6	2.6
EVH 125-0.8-1	80 (22)	0.8	3.5
EVH 125-1.2-1	90 (25)	1.2	5.2
EVH 150-0.8-1	80 (22)	0.8	3.5
EVH 150-1.2-1	90 (25)	1.2	5.2
EVH 150-1.7-1	160 (44)	1.7	7.4
EVH 150-2.0-1	170 (47)	2.0	8.7
EVH 160-0.8-1	80 (22)	0.8	3.5
EVH 160-1.2-1	150 (42)	1.2	5.2
EVH 160-1.7-1	160 (44)	1.7	7.4
EVH 160-2.0-1	170 (47)	2.0	8.7
EVH 200-1.2-1	150 (42)	1.2	5.2
EVH 200-1.7-1	160 (44)	1.7	7.4
EVH 200-2.0-1	170 (47)	2.0	8.7
EVH 250-1.2-1	180 (50)	1.2	5.2
EVH 250-2.0-1	200 (56)	2.0	8.7
EVH 250-3.0-1	375 (104)	3.0	13.0
EVH 315-2.0-1	220 (61)	2.0	8.7
EVH 315-3.0-1	320 (89)	3.0	13.0

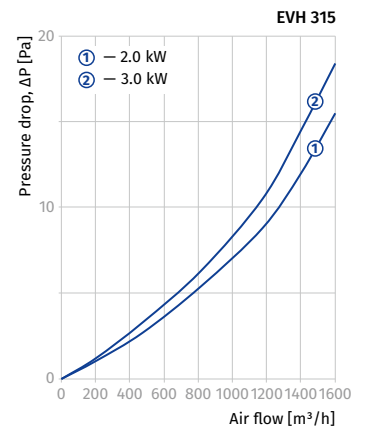
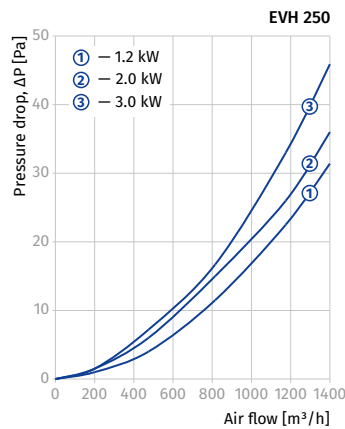
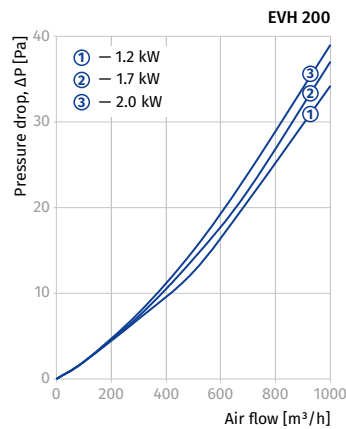
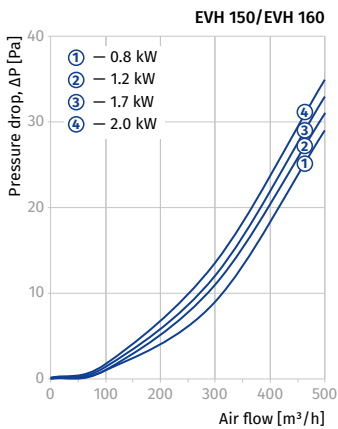
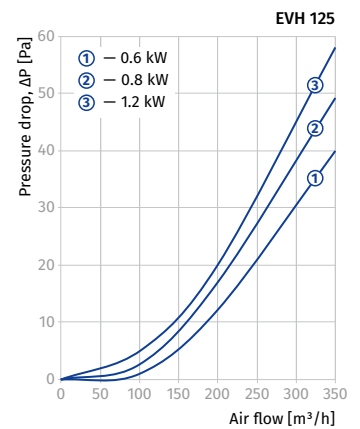

### Heater capacity selection diagram

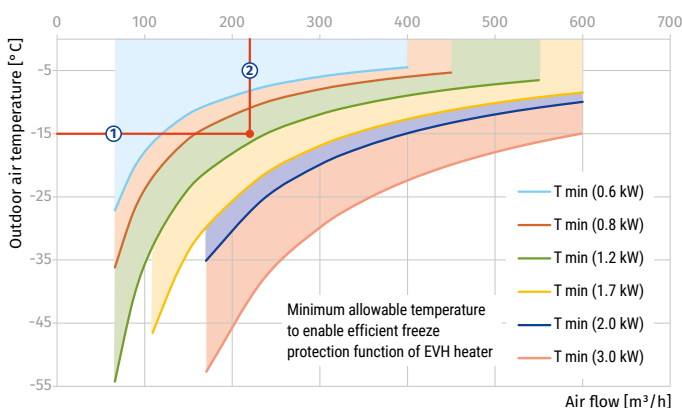

#### EVH heater parameters calculation example:

- It is necessary to select EVH freeze protection heater for the KOMFORT EC SB 350 S21 unit. Design outdoor air temperature in cold season is -15 °C. Design capacity is 220 m³/h.
- Identify the interception point of the air flow line (1) with the outdoor temperature line (2). In this case the heater with the capacity of 1200 W will assure efficient freeze protection of the heat exchanger. Select the **EVH 160-1.2-1** heater with the diameter corresponding to the diameter of the spigot of the KOMFORT EC SB 350 S21 unit.

# ENH S21 V.2

## Duct heater for supply air reheating

### Features

- The heater is designed for integration into a ventilation system and joint operation with an air handling unit equipped with a control system used to switch on the heater and control its operation.
- The heater maintains the supply duct air temperature at a point set by the unit controller.
- Compatible with  $\varnothing$  125 up to 315 mm air ducts.



### Design

- The casing, the junction box and the heater cover are made of galvanized steel with the heating elements in stainless steel. The heater casing is additionally heat-insulated with 20 mm non-flammable mineral wool layer. The heaters are equipped with rubber seals for airtight connection to the air ducts.
- **ENH S21 V.2** duct heaters are equipped with a factory-wired power supply cable and control cable, as well as a duct temperature sensor which is connected to the air handling unit.
- The temperature is controlled smoothly by the air handling unit controller using a PWM signal in cycles of 10 seconds. Load commutation is carried out by a semiconductor device (triac). The heaters are equipped with overheat thermostats:
  - main overheat protection with automatic reset at +60 °C
  - emergency overheat protection with manual reset at +90 °C.

### Mounting

- The heater design ensures its mounting on the round ducts in any position by means of clamps (included in delivery). The air flow direction shall match the direction of the arrow on the heater casing.
- In case of horizontal mounting the control box must be installed with the cover upwards. Swivel range from the normal position up to max. 90°. Do not install the control box with the cover downward.

### Compatibility chart

Heater model	Unit model
ENH 125 S21 V.2	KOMFORT EC SB unit with a $\varnothing$ 125 pipe and an S21 automation without a DB-9M connector
ENH 150 S21 V.2	KOMFORT EC SB unit with a $\varnothing$ 150 pipe and an S21 automation without a DB-9M connector
ENH 160 S21 V.2	KOMFORT EC SB unit with a $\varnothing$ 160 pipe and an S21 automation without a DB-9M connector
ENH 200 S21 V.2	KOMFORT EC SB unit with a $\varnothing$ 200 pipe and an S21 automation without a DB-9M connector
ENH 250 S21 V.2	KOMFORT EC SB unit with a $\varnothing$ 250 pipe and an S21 automation without a DB-9M connector
ENH 315 S21 V.2	BlauAIR unit with a $\varnothing$ 315 pipe and an S21 automation without a DB-9M connector

### Overall dimensions [mm]

Model	$\varnothing$ D	B	H	L	L1
ENH 125-0.6-1	125	164	249	306	192
ENH 125-0.8-1	125	164	249	306	192
ENH 125-1.2-1	125	164	249	306	192
ENH 150-0.8-1	150	189	280	306	192
ENH 150-1.2-1	150	189	280	306	192
ENH 150-1.7-1	150	189	280	306	192
ENH 150-2.0-1	150	189	280	306	192
ENH 160-0.8-1	160	197	291	306	192
ENH 160-1.2-1	160	197	291	306	192
ENH 160-1.7-1	160	197	291	306	192
ENH 160-2.0-1	160	197	291	306	192
ENH 200-1.2-1	200	239	336	306	192
ENH 200-1.7-1	200	239	336	306	192
ENH 200-2.0-1	200	239	336	306	192
ENH 250-1.2-1	250	287	388	307	192
ENH 250-2.0-1	250	287	388	307	192
ENH 250-3.0-1	250	287	388	307	192
ENH 315-2.0-1	315	353	454	306	192
ENH 315-3.0-1	315	353	454	306	192

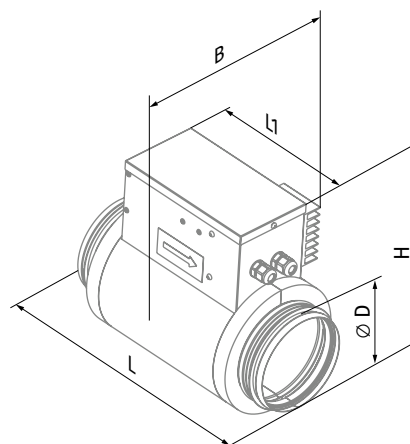

### Designation key

Series	Connected air duct diameter [mm]	Heater power [kW]	Number of phases	Compatibility with automation
ENH	125; 150; 160; 200; 250; 315	– 0.6; 0.8; 1.2; 1.7; 2.0; 3.0	– 1: single-phase	S21 V.2: compatible with an S21 automation without a DB-9M connector

### Technical data

Parameters	Min. air flow [m³/h (l/s)]	Power [kW]	Current [A]
ENH 125-0.6-1	60 (17)	0.6	2.6
ENH 125-0.8-1	80 (22)	0.8	3.5
ENH 125-1.2-1	90 (25)	1.2	5.2
ENH 150-0.8-1	80 (22)	0.8	3.5
ENH 150-1.2-1	90 (25)	1.2	5.2
ENH 150-1.7-1	160 (44)	1.7	7.4
ENH 150-2.0-1	170 (47)	2.0	8.7
ENH 160-0.8-1	80 (22)	0.8	3.5
ENH 160-1.2-1	150 (42)	1.2	5.2
ENH 160-1.7-1	160 (44)	1.7	7.4
ENH 160-2.0-1	170 (47)	2.0	8.7
ENH 200-1.2-1	150 (42)	1.2	5.2
ENH 200-1.7-1	160 (44)	1.7	7.4
ENH 200-2.0-1	170 (47)	2.0	8.7
ENH 250-1.2-1	180 (50)	1.2	5.2
ENH 250-2.0-1	200 (56)	2.0	8.7
ENH 250-3.0-1	375 (104)	3.0	13.0
ENH 315-2.0-1	220 (61)	2.0	8.7
ENH 315-3.0-1	320 (89)	3.0	13.0

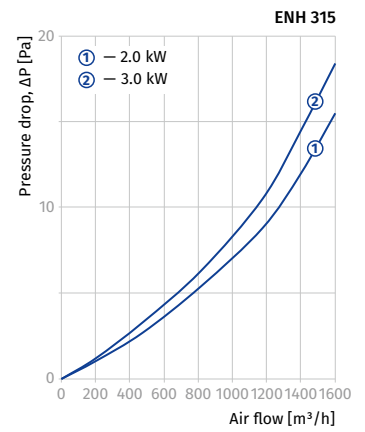
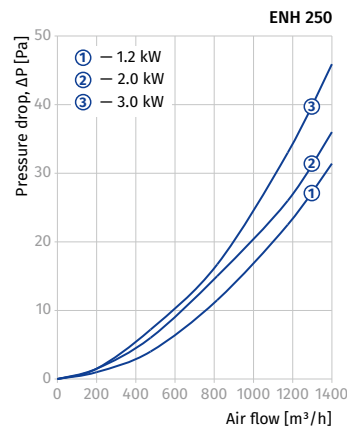
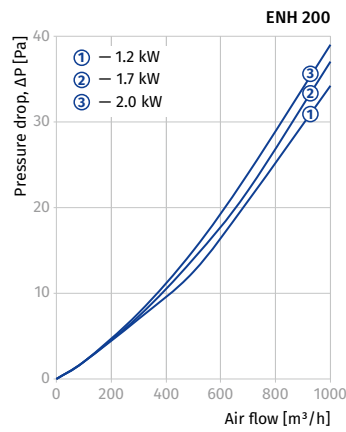
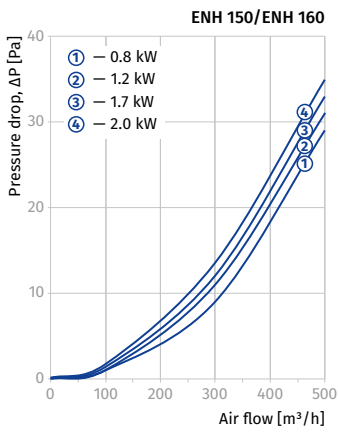
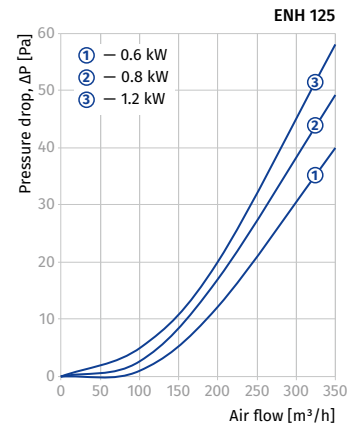

### Heater capacity selection diagram

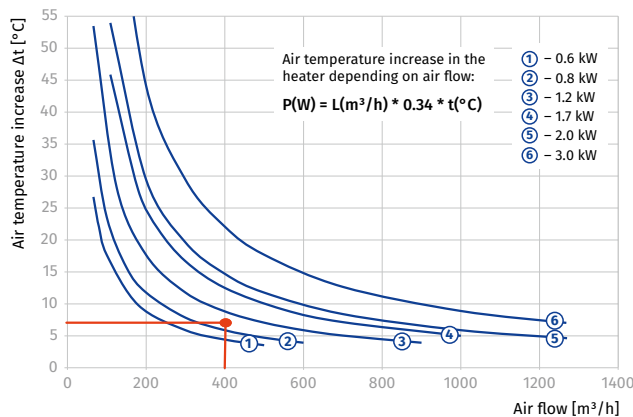

• **The ENH heater parameters calculation example:**

- It is necessary to select a heater for supply air post-heating to a temperature of +24 °C, provided the temperature downstream of the heat exchanger is +17 °C. Therefore it is essential to increase temperature by +7 °C. The ventilation system incorporates the KOMFORT EC SB 350 S21. Rated air capacity 400 m³/h.
- Determine the intersection of the post-heating temperature line (+7 °C) and the rated air capacity line (400 m³/h). In this case the 1200 W heater capacity provides necessary post-heating (+7 °C). The **ENH 160-1.2-1** with the diameter matching the spigot diameter of the air handling unit KOMFORT EC SB 350 S21 is a suitable model.

# SD

## Silencers for round ducts

### Features

- For attenuation of noise produced by a ventilation system and spreaded along ventilation ductworks.
- Used jointly with sound-insulated fans in premises with high requirements to noise level produced by ventilation equipment.
- Compatible with Ø 100 mm up to 315 mm round air ducts.



### Design

- Galvanized steel case is filled with non-flammable sound-absorbing material with protecting covering against fiber blowing.
- Airtight connection with air ducts due to connecting flanges with rubber seals.
- A great variety of standard ranges with several length options.

### Mounting

- Fixing to round ducts with clamps.
- Any mounting position.
- For better sound absorption install the silencers in Series.

### Designation key

Series	Connected air duct diameter [cm]	Length
SD	100; 125; 150; 160; 200; 250; 315	600; 900; 1200

### Overall dimensions [mm]

Model	D	D1	L	L1	Weight [kg]
SD 100/600	99	200	600	50	2.2
SD 100/900	99	200	900	50	3.2
SD 100/1200	99	200	1200	50	4.3
SD 125/600	124	225	600	50	2.7
SD 125/900	124	225	900	50	4.1
SD 125/1200	124	225	1200	50	5.4
SD 150/600	149	250	600	50	2.8
SD 150/900	149	250	900	50	4.2
SD 150/1200	149	250	1200	50	5.6
SD 160/600	159	260	600	50	3.1
SD 160/900	159	260	900	50	4.6
SD 160/1200	159	260	1200	50	6.2
SD 200/600	199	300	600	50	3.5
SD 200/900	199	300	900	50	5.3
SD 200/1200	199	300	1200	50	7.1
SD 250/600	249	350	600	50	4.2
SD 250/900	249	350	900	50	6.2
SD 250/1200	249	350	1200	50	8.3
SD 315/600	314	415	600	50	4.7
SD 315/900	314	415	900	50	7.1
SD 315/1200	314	415	1200	50	9.4

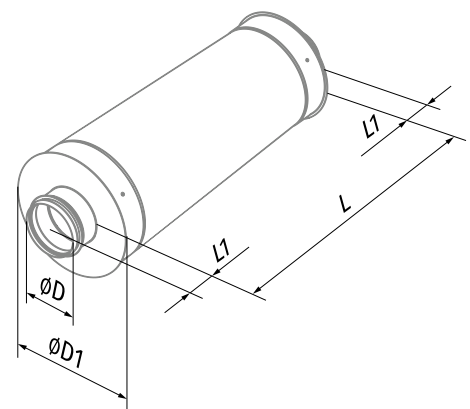



**Noise level reduction, dB (octave-frequency band [Hz])**

Model	63 Hz	125 Hz	250 Hz	500 Hz	1000 Hz	2000 Hz	4000 Hz	8000 Hz
SD 100/600	4	8	10	20	34	30	13	14
SD 100/900	5	10	15	23	44	30	16	15
SD 100/1200	6	11	19	28	50	34	20	18
SD 125/600	3	5	6	15	28	17	10	9
SD 125/900	4	9	12	22	43	22	16	12
SD 125/1200	4	9	16	27	48	27	21	17
SD 150/600	2	4	8	16	32	11	7	7
SD 150/900	3	5	9	18	36	25	13	14
SD 150/1200	4	8	14	25	43	30	18	19
SD 160/600	2	4	8	17	33	11	7	7
SD 160/900	2	5	10	19	37	25	13	15
SD 160/1200	4	10	14	24	42	30	19	20
SD 200/600	2	4	6	10	27	13	7	7
SD 200/900	3	7	11	20	39	23	8	7
SD 200/1200	4	10	14	23	40	26	13	12
SD 250/600	4	5	6	11	22	12	7	6
SD 250/900	4	5	7	16	32	20	12	10
SD 250/1200	4	6	8	17	34	22	14	12
SD 315/600	2	4	5	10	17	9	6	5
SD 315/900	3	5	8	17	30	14	10	8
SD 315/1200	4	7	11	22	36	18	14	10

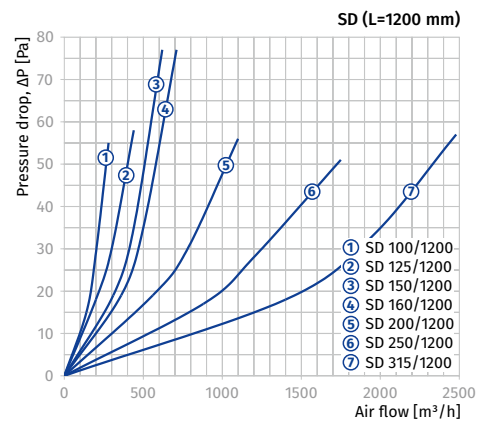
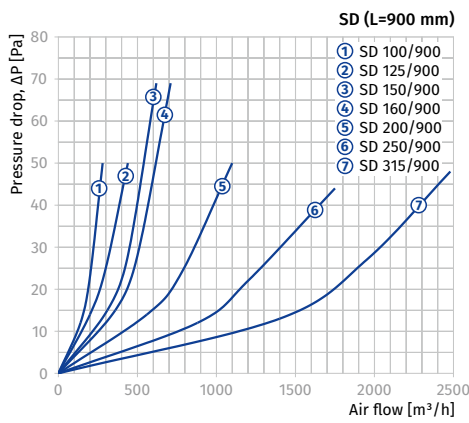
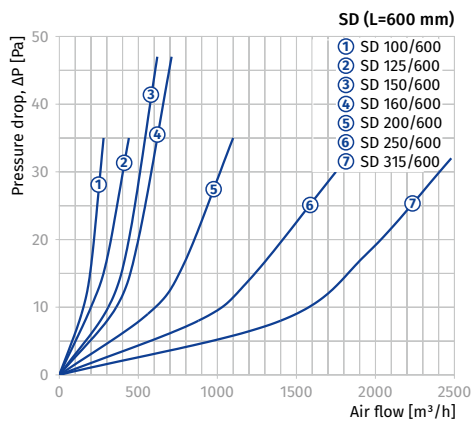

# SD

## Silencers for rectangular ducts

### Features

- For attenuation of the noise produced by a ventilation system and spreaded along ventilation ductworks.
- Used jointly with sound-insulated fans in premises with high requirements to noise level produced by ventilation equipment.
- Compatible with 400x200 mm up to 1000x500 mm rectangular air ducts.



### Design

- Galvanized steel case and sleeves.
- The plates are filled with non-flammable sound-absorption material with protecting coating to prevent fiber blowing.

### Mounting

- Fixing to rectangular ducts with flange connection.
- For maximum sound absorption capacity provide a straight air duct section at least 1 m long towards the silencer.
- For better sound absorption install the silencers in Series

### Designation key

Series	Flange size (WxH) [mm]
SD	40x20; 50x25; 50x30; 60x30; 60x35; 70x40; 80x50; 90x50; 100x50

### Overall dimensions [mm]

Model	B	B1	B2	H	H1	H2	L	Weight [kg]
SD 40x20	400	420	440	200	220	240	950	18.5
SD 50x25	500	520	540	250	270	290	950	20.5
SD 50x30	500	520	540	300	320	340	950	24.5
SD 60x30	600	620	640	300	320	340	950	26.5
SD 60x35	600	620	640	350	370	390	950	28.7
SD 70x40	700	720	740	400	420	440	1010	36.7
SD 80x50	800	820	840	500	520	540	1010	50.0
SD 90x50	900	920	940	500	520	540	1010	51.7
SD 100x50	1000	1020	1040	500	520	540	1010	57.3

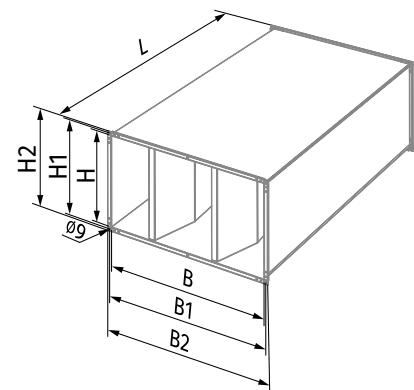

### Noise level reduction, dB (octave-frequency band [Hz])

Model	63 Hz	125 Hz	250 Hz	500 Hz	1000 Hz	2000 Hz	4000 Hz	8000 Hz
SD 40x20	3	7	10	23	27	30	25	22
SD 50x25	3	6	11	22	26	25	27	22
SD 50x30	3	6	10	23	24	25	23	18
SD 60x30	3	6	10	21	24	30	24	17
SD 60x35	3	5	11	22	25	29	24	21
SD 70x40	4	7	10	15	22	19	21	18
SD 80x50	5	6	11	17	21	20	22	20
SD 90x50	3	6	10	16	20	20	21	15
SD 100x50	4	6	11	16	21	21	23	17

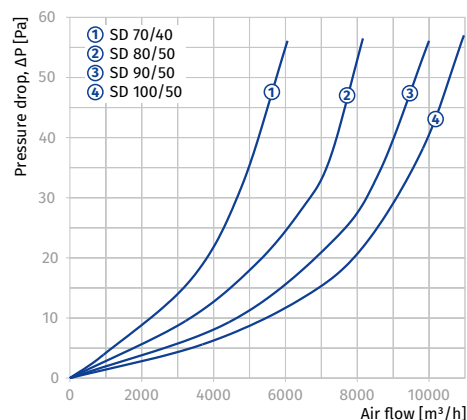
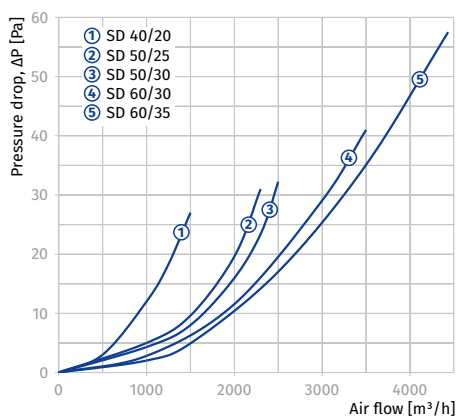

# VK

## Air dampers for round ducts

### Features

- For manual regulation of air flow volume in the air ducts.
- Compatible with Ø 80 to 450 mm round air ducts.



### Design

- The casing and the rotary blade are made of galvanized steel.
- Airtight connection to air ducts due to rubber seals.
- Air flow manual regulation with a metal handle equipped with a lever and a locking device for fixing the position of the rotary blades.

### Mounting

- Fixing to round ducts with clamps.

### Designation key

Series	Connected air duct diameter [mm]
VK	80; 100; 125; 150; 160; 200; 250; 315; 355; 400; 450

### Overall dimensions [mm]

Model	Ø D	B	L	Weight [kg]
VK 80	79	140	200	0.57
VK 100	99	170	200	0.68
VK 125	124	195	200	0.82
VK 150	149	220	200	0.95
VK 160	159	230	200	1.01
VK 200	199	270	200	1.29
VK 250	249	320	200	1.64
VK 315	314	385	240	2.51
VK 355	348	425	240	2.84
VK 400	399	470	240	3.38
VK 450	449	520	240	3.94

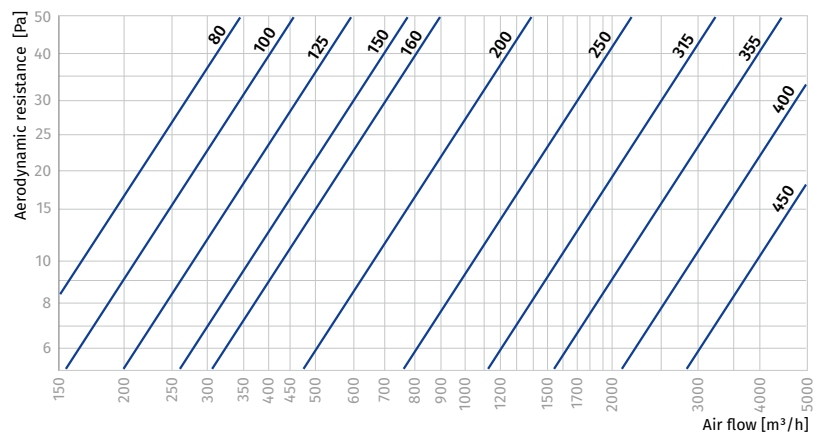
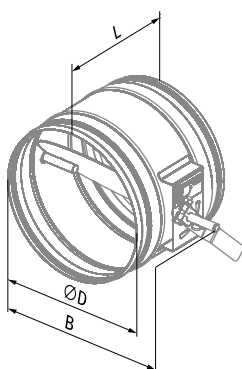

# VKA

## Air dampers for round ducts

### Features

- For automatic shutoff of air ducts installed in ventilation systems of various premises.
- Compatible with  $\varnothing$  80 to 450 mm round air ducts.



### Design

- The casing and the rotary blade are made of galvanized steel.
- Airtight connection to air ducts due to rubber seals.
- A shaft and a mounting pad are provided for BELIMO electric actuator. Compatible actuators are shown in the table below.

### Designation key

Series	Connected air duct diameter [mm]
VKA	80; 100; 125; 150; 160; 200; 250; 315; 355; 400; 450

### Overall dimensions [mm]

Model	$\varnothing$ D	B	L	H	Weight [kg]
VKA 80	79	190	200	170	0.6
VKA 100	99	220	200	180	0.72
VKA 125	124	245	200	195	0.86
VKA 150	149	270	200	205	1.01
VKA 160	159	280	200	210	1.07
VKA 200	199	320	200	230	1.33
VKA 250	249	370	200	255	1.68
VKA 315	314	435	240	-	2.44
VKA 355	348	475	240	-	2.75
VKA 400	399	520	240	-	3.26
VKA 450	449	570	240	-	3.78

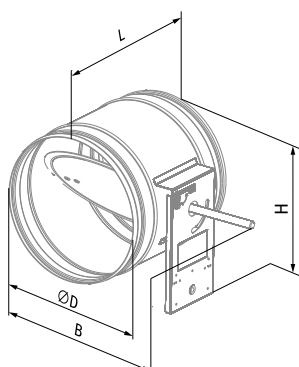

### Mounting

- Fixing to round ducts with clamps.
- While mounting provide enough space for accessing the electric actuator.

### Compatibility table

Compatibility table for shutters with an electrical actuator

Model	Actuator type			
	Electric actuator, 230 V	Electric actuator with spring return, 230 V	Electric actuator, 24 V	Electric actuator with spring return, 24 V
VKA 80	CM230 / LM230A	TF230	CM24 / LM24A	TF24
VKA 100	CM230 / LM230A	TF230	CM24 / LM24A	TF24
VKA 125	CM230 / LM230A	TF230	CM24 / LM24A	TF24
VKA 150	CM230 / LM230A	TF230	CM24 / LM24A	TF24
VKA 160	CM230 / LM230A	TF230	CM24 / LM24A	TF24
VKA 200	CM230 / LM230A	TF230	CM24 / LM24A	TF24
VKA 250	CM230 / LM230A	TF230	CM24 / LM24A	TF24
VKA 315	CM230 / LM230A	TF230	CM24 / LM24A	TF24
VKA 355	CM230 / LM230A	TF230	CM24 / LM24A	TF24
VKA 400	CM230 / LM230A	TF230	CM24 / LM24A	TF24
VKA 400	CM230 / LM230A	TF230	CM24 / LM24A	TF24

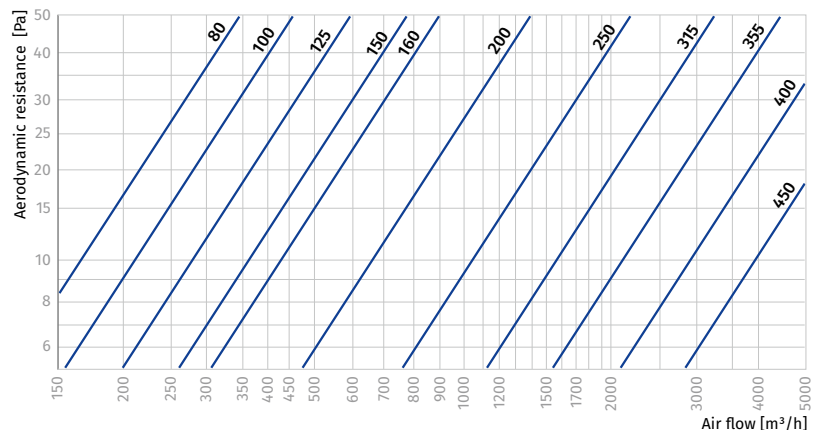

# VRV

## Backdraft dampers with spring for round ducts

### Features

- For automatic shutoff of the air ducts and prevention of back drafting when the fan is off. Suitable for installation in various premises.
- Compatible with Ø 100 up to 315 mm round air ducts.



### Design

- Galvanized steel case.
- Two spring-loaded blades made of aluminium.
- Blades are opened by air pressure and are closed with a spring.

### Mounting

- Fixing to round ducts with clamps.
- Provide vertical position of blade axis.
- Install the backdraft damper into the ventilation system with respect to the air flow direction.

### Designation key

Series	Connected air duct diameter [mm]
VRV	100; 125; 150; 160; 200; 250; 315

### Overall dimensions [mm]

Model	D	L	Weight [kg]
VRV 100	99	80	0.18
VRV 125	124	100	0.27
VRV 150	149	115	0.38
VRV 160	159	120	0.42
VRV 200	199	145	0.63
VRV 250	249	165	0.90
VRV 315	314	190	1.31

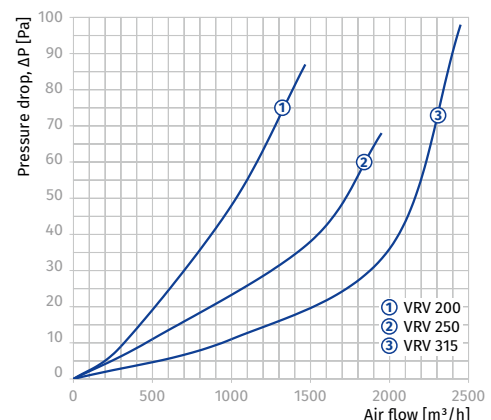
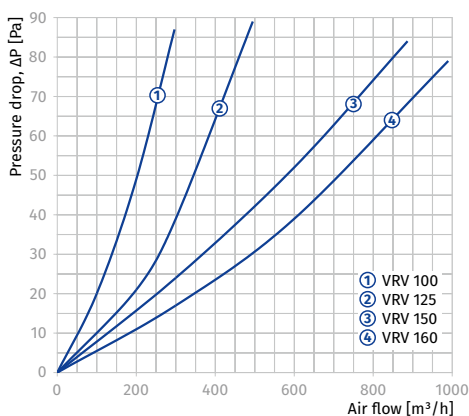
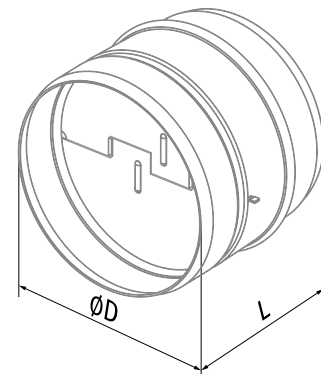

# VK

## Air dampers for rectangular ducts

### Features

- For manual regulation of air flow or shut-off of air ducts.
- Compatible with 400x200 up to 600x350 mm rectangular air ducts.



### Design

- Galvanized steel case and rotary blade.
- Manual regulation with a metal handle equipped with a lever and a locking device for fixing the position of the rotary blade.

### Mounting

- Fixing to rectangular ducts with flange connection.
- Mounting with galvanized bolts and clamps that fix the end flanges of the air shutter to the mating flanges of the air ducts or any other ventilation system components.

### Designation key

Series	Flange size [cm]
VK	40x20; 50x25; 50x30; 60x30; 60x35

### Overall dimensions [mm]

Model	B	B1	B2	H	H1	L	Weight [kg]
VK 40x20	400	440	460	200	240	202	3.0
VK 50x25	500	540	560	250	290	202	3.8
VK 50x30	500	540	560	300	340	202	3.1
VK 60x30	600	640	660	300	340	202	4.2
VK 60x35	600	640	660	350	390	202	5.1

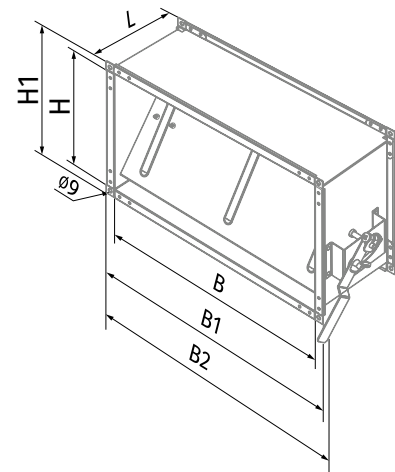
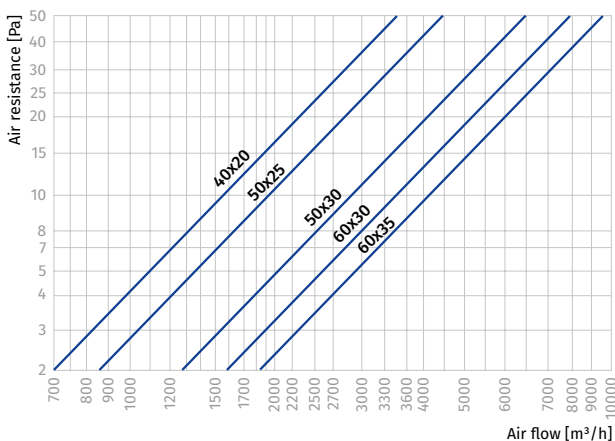

# AVK

## Air dampers for rectangular ducts

### Features

- For automatic regulation of air flow volume or shut-off of air ducts installed in various premises.
- Compatible with 400x200 up to 600x350 mm rectangular air ducts.

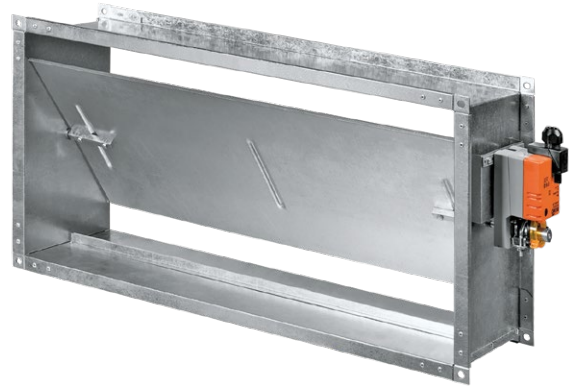

### Design

- Galvanized steel case and rotary blade.
- Automatic control of the regulating mechanism with a servo actuator installed on the damper shaft. Three-point circuit provides regulation of the rotary blade; adjustable with mechanical stop blocks, maximum angle 95°. The servo actuator has overheating protection.
- Switching to manual control mode if required.

### Mounting

- Fixing to rectangular ducts with flange connection.
- Mounting with galvanized bolts and clamps that fix the end flanges of the air shutter to the mating flanges of the air ducts or any other ventilation system components.
- While mounting provide enough space for accessing the servo actuator.

### Designation key

Series	Flange size [cm]
AVK	40x20; 50x25; 50x30; 60x30; 60x35

### Overall dimensions [mm]

Model	B	B1	B2	H	H1	L	Weight [kg]
AVK 40x20	400	440	503	200	240	202	3.6
AVK 50x25	500	540	603	250	290	202	4.4
AVK 50x30	500	540	603	300	340	202	4.8
AVK 60x30	600	640	703	300	340	202	5.4
AVK 60x35	600	640	703	350	390	202	5.8

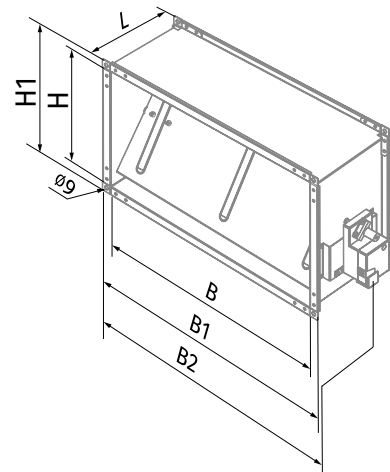
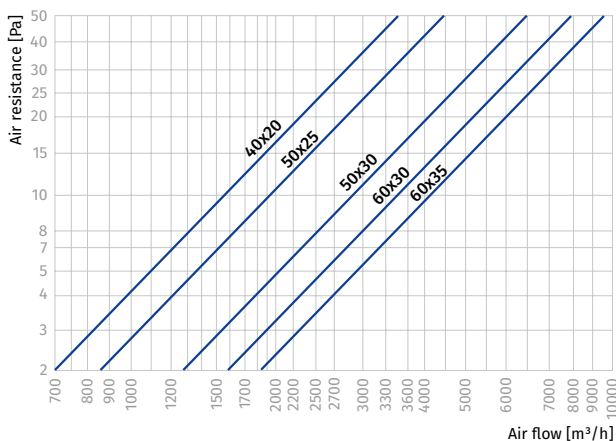



# VRVS

## Backdraft air dampers for rectangular ducts

### Features

- o For automatic shut-off of the air ducts and prevention of back drafting when the fan off. Suitable for installation in various premises.
- o Compatible with 400x200 up to 600x350 mm rectangular air ducts.

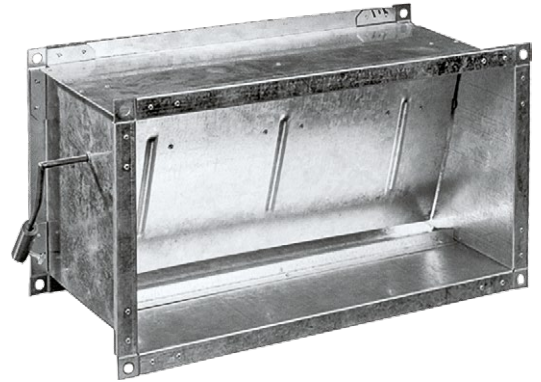

### Design

- o Galvanized steel case and rotary gravity-actuated blade.
- o The damper blade is opened with air pressure and reset automatically when the fan is off and no air pressure is produced.
- o Manual handle with a counterweight to regulate the damper opening-closing sensitivity.

### Mounting

- o Fixing to rectangular ducts in upright position.
- o Provide free gravity actuated movement of the blade.
- o Install the backdraft damper into the ventilation system with respect to the air flow direction.

### Designation key

Series	Flange size [cm]
VRVS	40x20; 50x25; 50x30; 60x30; 60x35

### Overall dimensions [mm]

Model	B	B1	B2	H	H1	L	Weight [kg]
VRVS 40x20	400	440	461	200	240	202	2.9
VRVS 50x25	500	540	561	200	290	202	3.73
VRVS 50x30	500	540	561	300	340	202	4.1
VRVS 60x30	600	640	661	300	340	202	4.64
VRVS 60x35	600	640	661	350	390	202	5.03

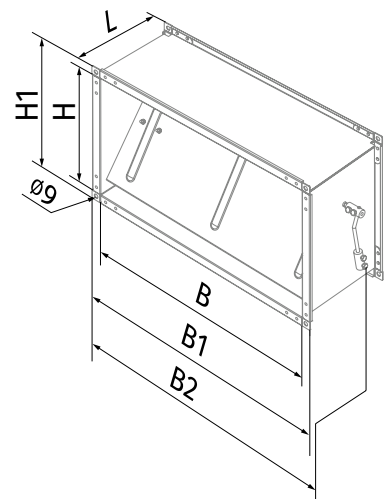

# SL

## Air dampers for rectangular ducts

### Features

- For manual regulation of air flow volume or shut-off of air ducts installed in ventilation systems of various premises.
- Compatible with 400x200 mm up to 1000x500 mm rectangular air ducts.



### Design

- The multi-blade design with the counter-rotated blades.
- The casing is made of galvanized steel.
- The rotary blades from aluminium profile are rotated with the gears.
- Air flow manual regulation with a metal handle equipped with a lever and a locking device to fix position of the rotary blades.
- A shaft and a mounting pad are provided for BELIMO electric actuator. Compatible actuators are shown in the table below.

### Mounting

- Fixing to rectangular ducts with flange connection.
- Mounting with galvanized bolts and clamps that fix the end flanges of the air flow regulators to the mating flanges of the air ducts or any other ventilation system components.

### Designation key

Series	Flange size [cm]
SL	40x20; 50x25; 50x30; 60x30; 60x35; 70x40; 80x50; 90x50; 100x50

### Overall dimensions [mm]

Model	B	B1	B2	H	H1	L	Weight [kg]
SL 40x20	400	440	540	200	240	170	3.5
SL 50x25	500	540	640	250	290	170	4.2
SL 50x30	500	540	640	300	340	170	4.9
SL 60x30	600	640	740	300	340	170	5.4
SL 60x35	600	640	740	350	390	170	5.7
SL 70x40	700	740	840	400	440	170	7.7
SL 80x50	800	840	940	500	540	170	8.8
SL 90x50	900	940	1040	500	540	170	9.6
SL 100x50	1000	1040	1140	500	540	170	10.3

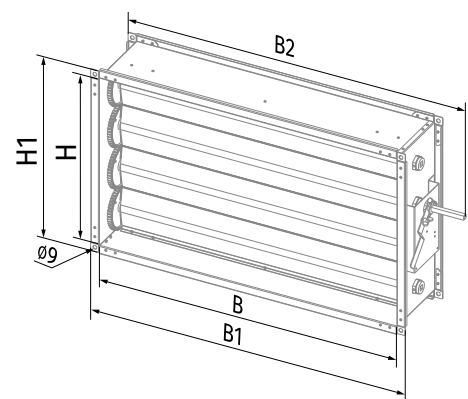

### Compatibility table of air dampers with electric actuators

	Actuator type			
	Electric actuator, 230 V	Electric actuator with spring return, 230 V	Electric actuator, 24 V	Electric actuator with spring return, 24 V
SL 40x20	CM230 / LM230A	TF230 / LF230	CM24 / LM24A	TF24 / LF24
SL 50x25	CM230 / LM230A	TF230 / LF230	CM24 / LM24A	TF24 / LF24
SL 50x30	CM230 / LM230A	TF230 / LF230	CM24 / LM24A	TF24 / LF24
SL 60x30	CM230 / LM230A	TF230 / LF230	CM24 / LM24A	TF24 / LF24
SL 60x35	CM230 / LM230A	TF230 / LF230	CM24 / LM24A	TF24 / LF24
SL 70x40	LM230A	LF230	LM24A	LF24
SL 80x50	LM230A	LF230	LM24A	LF24
SL 90x50	LM230A	LF230	LM24A	LF24
SL 100x50	LM230A	LF230	LM24A	LF24

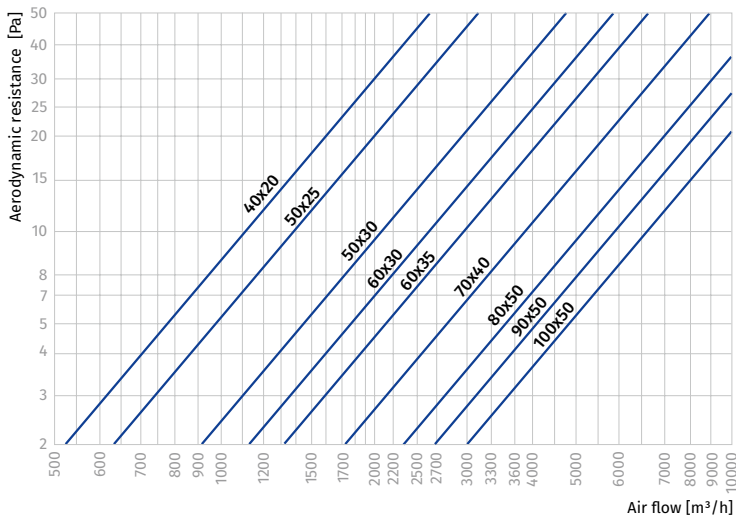

# KZ

## Clamps for round ducts

### Features

- For reliable fixing of ventilation system components.
- Compatible with 100 up to 315 mm round ventilation system components.



### Design

- Made of galvanized steel band.
- Sealed with microporous rubber from inside for vibration absorption.

### Mounting

- Fixed on round ventilation system components.
- Round ventilation system components are fixed by a clamp with two bolts.

### Designation key

Series	Connected air duct diameter [mm]
KZ	100; 125; 150; 160; 200; 250; 315

### Overall dimensions [mm]

Model	D	H	Weight [kg]
KZ 100	100	172	0.206
KZ 125	125	198	0.232
KZ 150	150	224	0.296
KZ 160	160	232	0.358
KZ 200	200	274	0.42
KZ 250	250	326	0.55
KZ 315	315	380	0.65

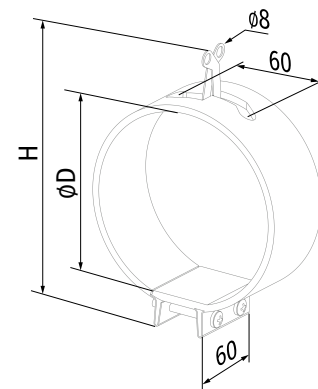

# KZH

## Clamps for round ducts

### Features

- For reliable fixing of ventilation system components installed in various premises.
- Compatible with 100 up to 315 mm round ventilation system components.



### Design

- Made of galvanized steel band.
- Sealed with microporous rubber from inside for vibration absorption.
- Equipped with a mounting bracket for fixing on wall or ceiling.

### Mounting

- Fixed on round ventilation system components.
- Round ventilation system components are fixed by a clamp with a bolt.
- For installation on wall or ceiling use a mounting bracket fixed with dowels.

### Designation key

Series	Connected air duct diameter [mm]
KZH	100; 125; 150; 160; 200; 250; 315

### Overall dimensions [mm]

Model	D	L	Weight [kg]
KZH 100	100	204	0.21
KZH 125	125	229	0.22
KZH 150	150	254	0.25
KZH 160	160	264	0.26
KZH 200	200	304	0.31
KZH 250	250	354	0.35
KZH 315	315	419	0.42

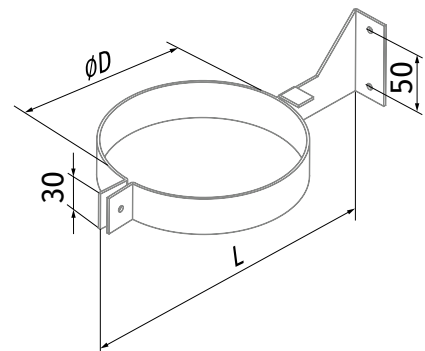

# SGR-3/1

## Sensor speed switch

### Features

- On/off switch and speed selection for multi-speed fans.



### Design

- Casing made of high-quality plastic.
- Glass sensor operating panel with three touch buttons for speed selection with light indication.
- Wall flush mounting.
- IP30 ingress protection rating.

### Control

- Required speed is activated by touching the respectively marked speed button.
- The fan is turned off by touching the current speed button.

### Mounting

- Designed for wall mounting in a flush mounting box.

### Technical data

Parameters	SGR-3/1
Voltage 50 (60) Hz [V]	110–240
Max. current load [A]	1
Number of speeds	3
Cable cross section [mm <sup>2</sup> ]	from 0.35 up to 1
Temperature range [°C]	from -10 up to +45
Operating humidity range [%]	from 5 up to 80 (no condensation)
Service life	100 000 operations
Ingress Protection	IP30
Weight [g]	138

SPEED CONTROLLERS

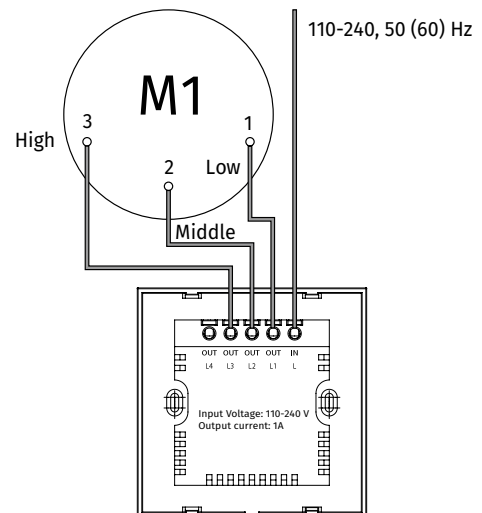
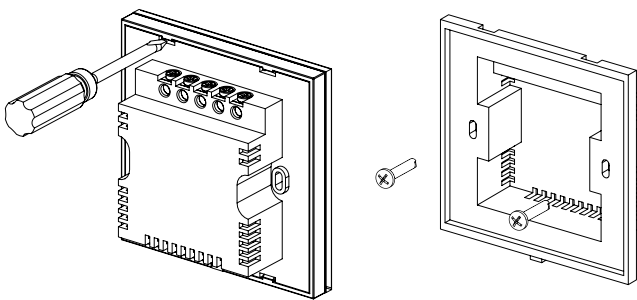

### Overall dimensions [mm]

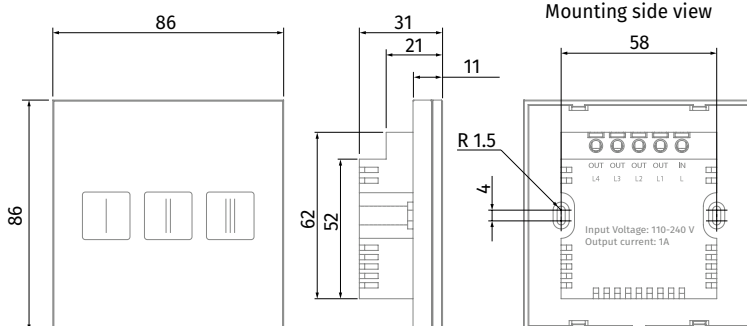

# CDP-2/5 (3/5)

## Multi-speed switch



### Features

- On/off switch and speed switch for multi-speed fans.

### Design

- Casing made of high-quality plastic.
- Flush wall mounting.
- IP40 ingress protection rating.

### Control

- Switching of fan speed according to diagram 1 and switching of fan speed in parallel with switching the light in the room, diagram 2.

### Mounting

- Indoor wall flush mounting in a mounting box.
- Suitable for installation in standard electric junction boxes.

### Technical data

Parameters	CDP-2/5	CDP-3/5
Voltage 50 Hz [V]	1 ~ 230	1 ~ 230
Rated current [A]	3.0	3.0
Number of speeds	2	3
Overall dimensions AxBxC [mm]	88x88x51	88x88x51
Maximum ambient temperature [°C]	+40	+40
Ingress Protection	IP40	IP40

### Wiring diagram options

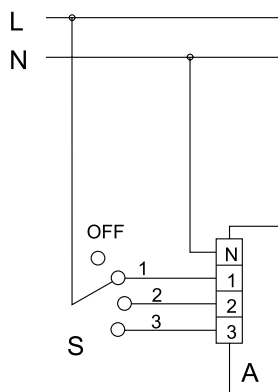

**Diagram 1.** The external switch S (CDP-3/5) switches the fan to one of three speeds and switches it off.

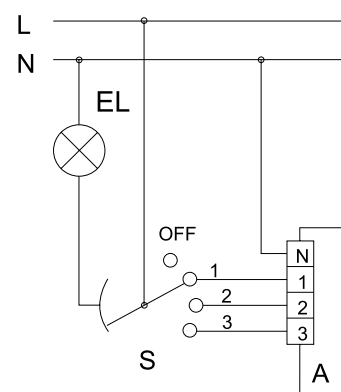

**Diagram 2.** The external switch S (CDP-3/5) switches the fan to one of three speeds and switches it off with parallel switching on/off the light in the room.

# CDT E1.8

## Thyristor speed controller

### Features

- For switching fans on/off and for speed control of single-phase frequency controlled motors. For ventilation systems in various premises.



### Design

- The casing is made of high-quality plastic.
- Mounting junction box for wall flush mounting.
- IP40 ingress protection rating.

### Control

- Switching on/off by the control knob.
- Smooth speed control from minimum to maximum value. Minimum speed is set by a variable resistor on the control panel.
- Several fans can be controlled from one unit provided that the total current consumption does not exceed the permissible controller current.
- High efficiency and control accuracy.

### Protection

- Input circuit protected with a thermal fuse.
- Equipped with a transient filter.

### Mounting

- Indoor wall flush mounting in a mounting box.
- Suitable for installation in standard electric junction boxes.

### Options

- Mounting box EDR-E for wall surface mounting available upon separate order.

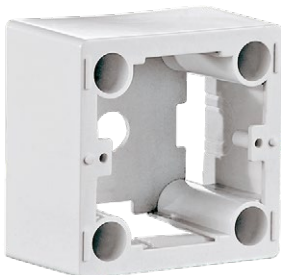

### Technical data

Parameters	CDT E1.8
Voltage 50 Hz [V]	1 ~ 230
Rated current [A]	1.8
Overall dimensions AxBxC [mm]	80x80x63
Maximum ambient temperature [°C]	+35
Ingress Protection	IP40
Weight [g]	0.11



# CDT E/0-10

## Speed control for EC motors



### Features

- For switching fans on/off and for speed control of EC motors with 0–10 V control voltage input.

### Design

- Casing made of high-quality plastic.
- Mounting junction box for wall flush mounting.
- IP40 ingress protection rating.

### Control

- Switching on/off by the control knob.
- Speed control from minimum to maximum value.
- Featured with high efficiency and control accuracy.

### Mounting

- Indoor wall flush mounting in a mounting box.
- Suitable for installation in standard electric junction boxes.

### Options

- Mounting box EDR-E for wall surface mounting available upon separate order.

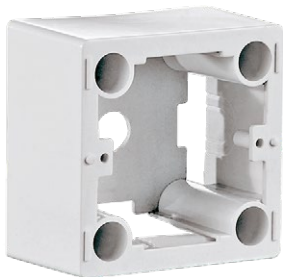

### Technical data

Parameters	CDT E/0-10
Voltage [V]	10–48 DC
Control signal [V]	0–10
Maximum current [mA]	5
Overall dimensions AxBxC [mm]	78x78x63
Maximum ambient temperature [°C]	+35
Ingress Protection	IP40
Weight [kg]	0.12

### Wiring diagram

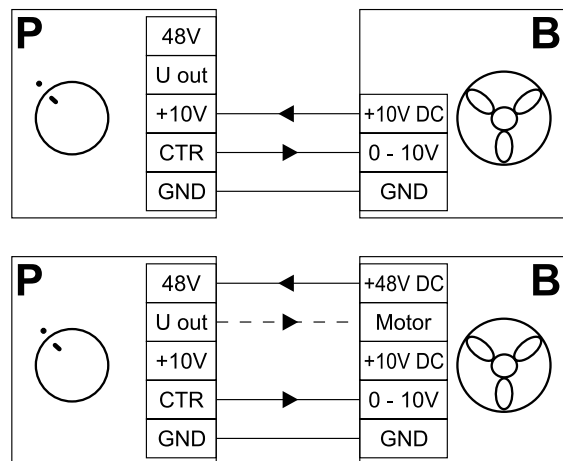

# CDTE E1.8

## Thyristor speed controller

### Features

- For switching fans on/off and for speed control of single-phase frequency controlled motors. For ventilation systems in various premises.



### Design

- Casing made of high-quality plastic.
- Surface box for mounting.
- IP40 ingress protection rating.

### Control

- Switching on/off by control knob.
- Smooth speed control from minimum to maximum value. The minimum rotation speed is set by a variable resistor on the control panel.
- Several fans can be controlled from one unit provided that the total current consumption does not exceed the permissible controller current.
- Featured with high efficiency and control accuracy.

### Protection

- Input circuit protected with a thermal fuse.
- Equipped with a transient filter.

### Mounting

- Indoor wall mounting.

### Technical data

Parameters	CDTE E1.8
Voltage 50 (60) Hz [V]	1 ~ 230
Rated current [A]	1.8
Overall dimensions AxBxC [mm]	80x80x64
Maximum ambient temperature [°C]	+35
Ingress Protection	IP40
Weight [kg]	0.11

### Wiring diagram

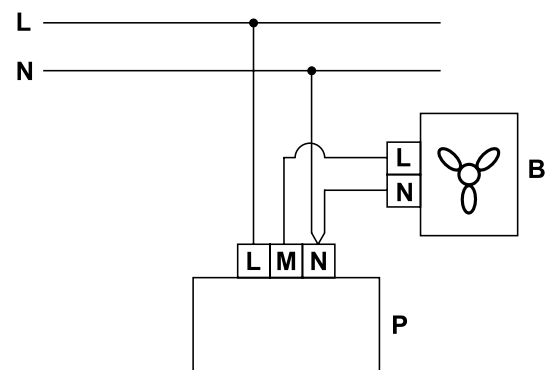

# CDTE E/0-10

## Speed controller for EC motors



### Features

- For switching the fan on/off and for speed control of EC motors with 0-10 V control voltage input.

### Design

- Casing made of high-quality plastic.
- Surface box for mounting.
- IP40 ingress protection rating.

### Control

- Switching on/off by control knob.
- Speed control from minimum to maximum value.
- Featured with high efficiency and control accuracy.

### Mounting

- Indoor wall mounting.

### Technical data

Parameters	CDTE E/0-10
Voltage [V]	10-48 DC
Control input [V]	0-10
Overall dimensions AxBxC [mm]	80x80x63
Max. ambient temperature [°C]	+35
Ingress Protection	IP40
Weight [kg]	0.12

### Wiring diagram

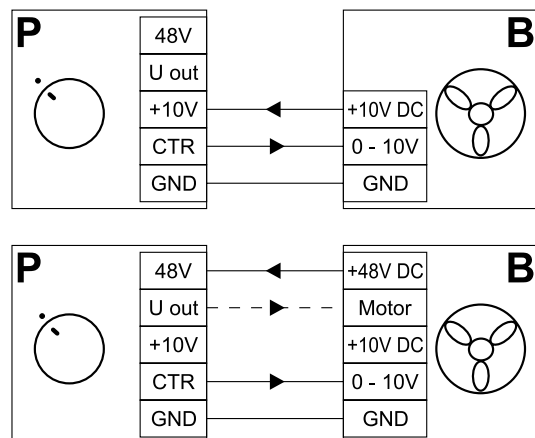

# CDT1 E

## Speed controller

### Features

- Applied in ventilation systems for speed switching ON/OFF and speed control of single phase power-controlled motors. Several fans can be controlled synchronously in case their total current does not exceed the maximum permissible value of the controller current.



### Design and control

- The controller casing is made of plastic. The control knob is equipped with the pilot light. The controller is featured with high efficiency and control accuracy. Switching is effected by means of pressing the control knob. Regulating starts from the minimum to the maximum voltage value for the fan stable running. The minimum speed is set by means of the potentiometer at the PCB. The controller is equipped with extra 230 V terminal for connection and control of the external equipment.

### Protection

- Input circuit of the speed controller has a thermal fuse for overload protection. The controller is fitted with a transient filter.

### Mounting

- The universal design of the controller enables its mounting either on the wall or through the wall, suitable for installation into standard round electric junction boxes.

### Technical data

Parameters	CDT1 E0.5	CDT1 E1.5	CDT1 E2.5	CDT1 E4.0
Voltage [V / 50 Hz]	1 ~ 230	1 ~ 230	1 ~ 230	1 ~ 230
Minimum current [A]	0.1	0.15	0.25	0.4
Maximum current [A]	0.5	1.5	2.5	4.0
Overall dimensions LxWxH [mm]	82x82x65	82x82x65	82x82x65	82x82x65
Maximum ambient temperature [°C]	+35	+35	+35	+35
Protection rating	IP44	IP44	IP44	IP44
Weight [kg]	0.23	0.24	0.29	0.36

### Wiring diagram

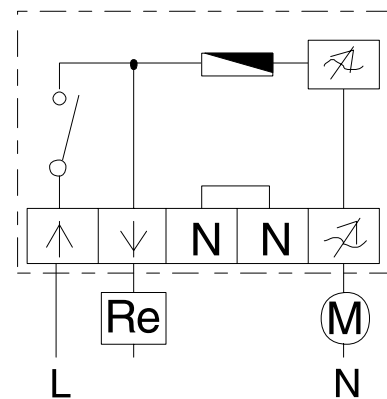
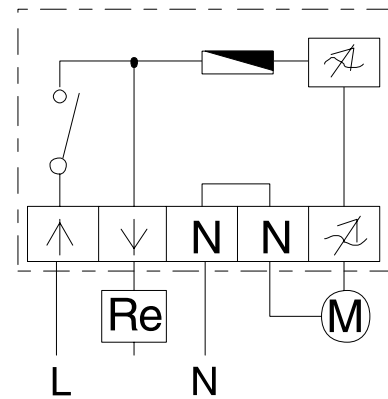

# S22 / S22 Wi-Fi

## Control panels

### Features

- The **S22 / S22 Wi-Fi** control panels are used for control of industrial and domestic air handling units with an **S21** automation system.



### Design

- Casing made of high-quality plastic.
- Glass sensor operating panel with touch buttons with light indication.
- IP40 ingress protection rating.

### Control panel functions

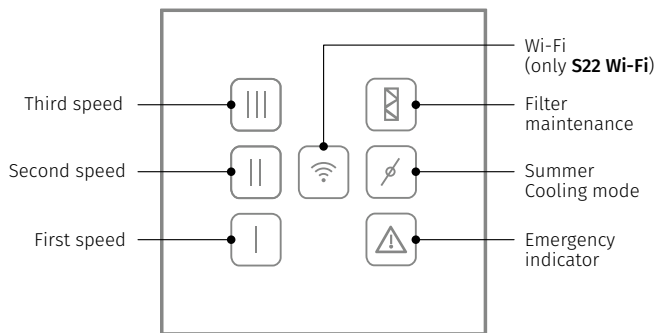

### Installation and connection

- The **S22 / S22 Wi-Fi** control panels are suitable for flush and surface mounting.
- The delivery set includes mounting boxes for flush and surface mounting.
- Connection of the control panel is carried out according to the User's manual of the unit.

### Overall dimensions [mm]

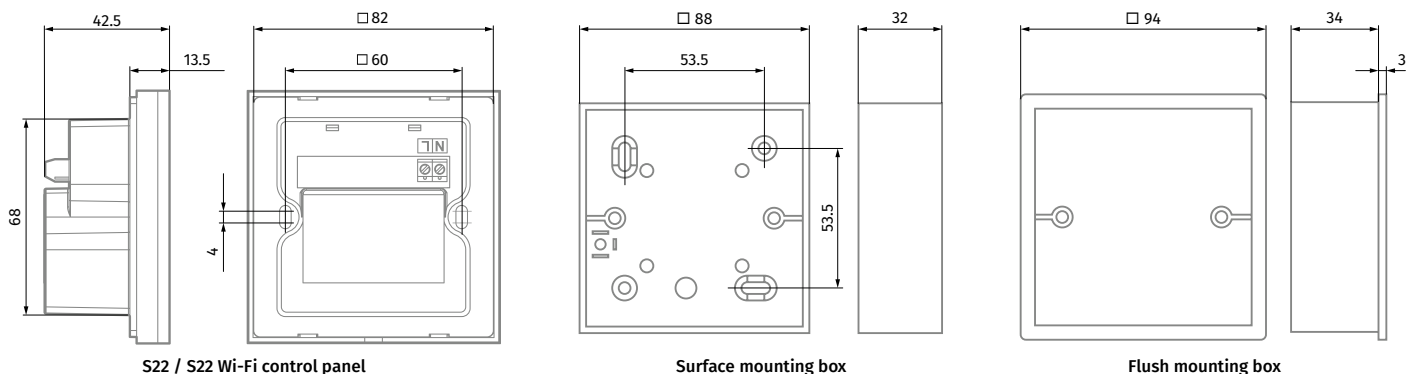

### Technical data

Parameters	S22	S22 Wi-Fi
Voltage [V]	24	110-230/50 (60) Hz
Maximum current [A]	0.025	0.012
Cable type [mm <sup>2</sup> ]	4x0.25	2x0.35
Temperature range [°C]	+10...+45	+10...+45
Humidity range [%]	10-80 (no condensation)	10-80 (no condensation)
Casing material	Plastic	Plastic
Sensor surface material	Glass	Glass
SEC class	IP40	IP40
Weight [g]	190	190

Wi-Fi data		
Standard	-	IEEE 802.11 b/g/n
Frequency band [GHz]	-	2.4
Transmission power [mW] (dBm)	-	100 (+20)
Network	-	DHCP
WLAN safety	-	WPA, WPA2

CONTROL PANELS

# S25

## Control panel with a sensor display

### Features

- For control of industrial and domestic air handling units with an S21 automation system.



### Design

- Casing made of high-quality plastic.
- The panel is equipped with a touch LCD display.
- Dust and moisture protection rating – IP20.

### Control functions

- Speed switching.
- Filter replacement indication (according to timer or filter clogging differential pressure switch readings).
- Alarm indication: full description of the alarm.
- Week-scheduled operation.
- Bypass (automatic and manual).
- Timer.
- Boost.
- Fireplace.
- Freeze protection.
- Control of electric and water preheaters and reheaters.
- Cooler connection.
- Supply air temperature control.
- Control of humidity, CO<sub>2</sub>, VOC, PM2.5.
- Fire alarm connection.

### Mounting

- Designed for indoor installation.
- Connection and mounting of the control panel are carried out according to the User's manual of the unit.

### Technical data

Parameters	S25
Voltage DC [V]	12–32
Current at 24 VDC [A]	0.1
Power cable (10 m), type	4 × 0.25 mm <sup>2</sup>
Temperature range [°C]	-10...+45
Humidity range [%]	10 – 80 (no condensation)
Ingress Protection	IP20

### Overall dimensions [mm]

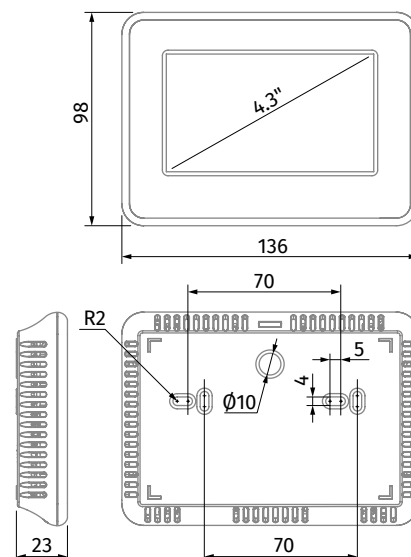

# CD-1 / CD-2

## CO<sub>2</sub> sensors

### Features

- o Indoor carbon dioxide concentration measurement.
- o Air flow control depending on CO<sub>2</sub> concentration.
- o Efficient energy saving device.



### Design

- o The sensor has two separate outputs, a normally opened dry relay contact and an analogue output 0–10 V that is adjustable fo 2–10 V/ 0–20 mA/4–20 mA.
- o The relay output is used to turn the fan on/off depending on indoor CO<sub>2</sub> concentration and the analogue output is used for smooth fan speed control for a fan with EC motor or a fan with extra speed controller with 0–10 V input. In case of smooth fan speed control the fan speed varies proportionally to carbon dioxide emissions.
- o Due to the relay and analogue outputs the sensor is compatible with any ventilation system. The self-calibration system ensures reliable sensor operation during the sensor service life.

### Modifications

- o **CD-1:** integrated LED lights for indication of CO<sub>2</sub> concentration and a touch button for operation mode switching (mode 1: on, mode 2: off, mode 3: operation according to CO<sub>2</sub> concentration). The button is used to turn the fan on or turn it off when CO<sub>2</sub>-based ventilation is not required.
- o **CD-2:** no integrated LED-lights and no touch button. This model is recommended for premises requiring permanent ventilation as school classes and other public premises.

### Mounting and power supply

- o Wall surface mounting.
- o 24 VAC low current power supply.
- o The sensor has a socket for AT power unit offered as an accessory (AT-220/25 or AT-120/25 models).



### Technical data

Parameters	Value
<b>Power supply / Consumption</b>	24 VAC (50 (60) Hz ± 10 %), 24 VDC/1.6 W Max
<b>Gas sensing element</b>	Non-dispersive infrared detector (NDIR) with self-calibration system
<b>CO<sub>2</sub>-measuring range</b>	0–2.000 ppm (parts per million)
<b>Accuracy at 25 °C, 2.000 ppm</b>	±30 ppm + 3 % of reading
<b>Response time</b>	max. 2 min
<b>Warm up time for each turning-on</b>	2 hours (first time), 2 minutes (operation)
<b>Analogue output</b>	0–10 VDC (default), 4–20 mA selectable by jumpers
<b>On/Off output</b>	1X2A switch load Four set points selectable by jumpers
<b>6 LED lights for CO<sub>2</sub> concentration indication (for CD-1 model)</b>	1st green indicator lights when CO <sub>2</sub> concentration is below 600 ppm 1st and 2nd green indicators light when CO <sub>2</sub> concentration is 600–800 ppm 1st yellow indicator lights when CO <sub>2</sub> concentration is 800–1200 ppm 1st and 2nd yellow indicators light when CO <sub>2</sub> concentration is 1200–1400 ppm 1st red indicator lights when CO <sub>2</sub> concentration is 1400–1600 ppm 1st and 2nd red indicators light when CO <sub>2</sub> concentration is above 1600 ppm
<b>Operating conditions / Storage regulations</b>	0–50 °C; 0–95 % RH non condensing/0–50 °C
<b>Weight/Dimensions</b>	0.12 kg/100 mm x 80 mm x 30 mm

### Sensor wiring diagram

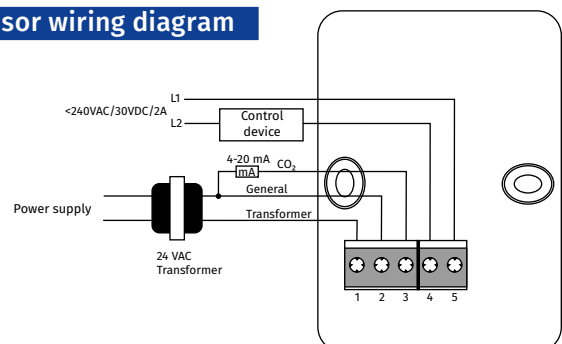

# HR-S

## Electro-mechanical humidistats

### Purpose

- The humidistat is designed for controlling humidification and/or dehumidification in ventilation, air conditioning and heating systems.
- Can also be used to alarm when the humidity exceeds or falls below a pre-set level.



### Design

- The single-stage humidistat HR-S uses a synthetic element as sensor medium. The synthetic element stretches as the humidity increases and shrinks as the humidity decreases.

### Mounting

- The humidistat is designed for indoor mounting on the wall surface.

### Humidistat wiring diagram

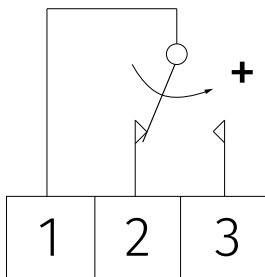

Humidification  
Dehumidification

Closing contact between terminals 1 and 2  
Closing contact between terminals 1 and 3

### Technical data

Parameters	HR-S
Switch contact	250 VAC, 5 A
Moisture [%]	20–90
Casing material	Polycarbonate
Temperature range [°C]	0–40
Mounting	Wall surface mounting
Ingress protection	IP30
Dimensions [mm]	86x86x30



# FS2

## Humidity sensor

### Features

- o The **FS2** humidity sensor is designed to control humidity in ventilation, air conditioning and heating systems.



### Overall dimensions [mm]

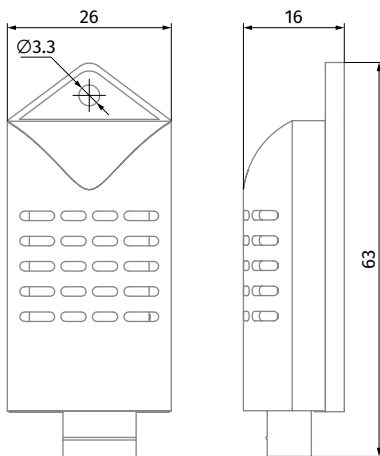

### Compatibility

- o The HV2 humidity sensor is compatible with air handling units with an S14 or S21 automation system.

### Mounting

- o Possible mounting options are shown below:

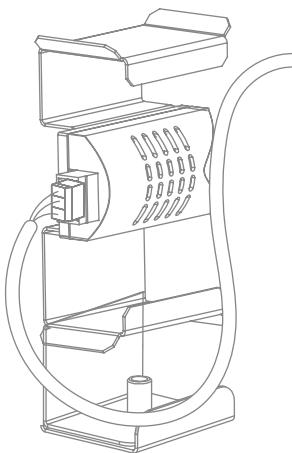

On the bracket in the exhaust air duct of the unit

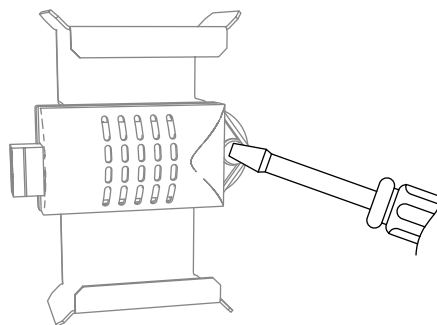

In the exhaust air duct of the unit on a threaded rivet or plastic support

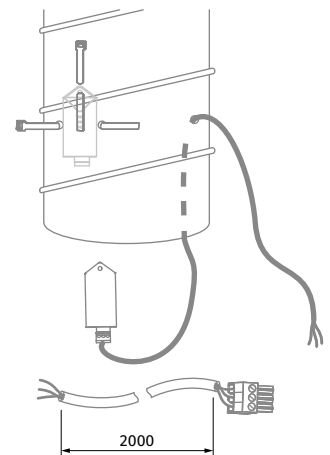

In the exhaust air duct upstream of the heat exchanger (only for KOMFORT EC S(B) 160(-E))

Find more details on the installation of the FS2 humidity sensor in the installation instructions.

# BELIMO TF230 / TF24

## Electric actuators

### Features

- For controlling air dampers with cross section up to 0.4 m<sup>2</sup> installed in various ventilation and air conditioning systems and performing protection functions.



### Design

- The electric actuator is provided with a 2 Nm actuating torque and an overload protection.
- The actuator is installed directly on the air damper shaft.
- The actuator is equipped with a return spring, which moves the damper to its operating position while tensioning the return spring at the same time. In case of power supply cut-off, the damper moves back to its safe position by the spring energy.
- The angle of rotation is adjusted by mechanical end stops.

### Wiring diagram

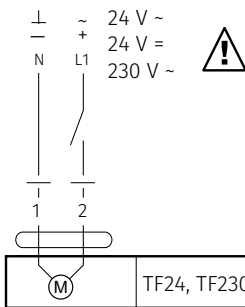

For TF24: connection via a power transformer  
For TF230: after disconnection from power supply the contacts opening gap must be within 3 mm.

Several electric actuators may be parallel connected with respect to the power

### Overall dimensions [mm]

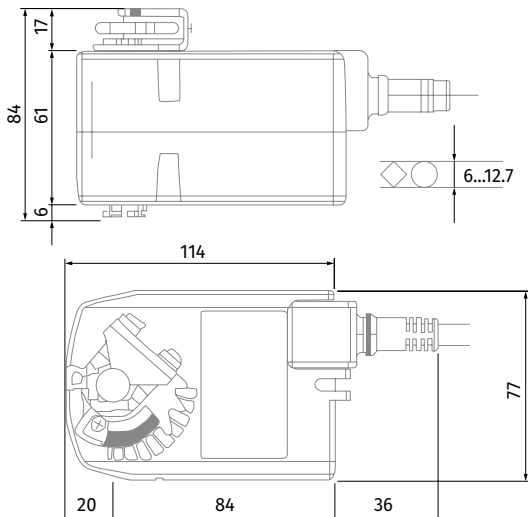

### Technical data

Parameters	TF24	TF230
<b>Voltage</b>	24 V ~ 50 (60) Hz, 24 V=	230 V ~ 50 (60) Hz
<b>Nominal voltage range [V]</b>	19.2...28.8 ~ 21.6...28.8 V=	85...265 ~
<b>Rated power [VA]</b>	4 (max. I 5.8 A at t = 5 ms)	4 (max. I 150 mA at t = 10 ms)
<b>Power consumption in operation / at rest [W]</b>	2 / 1.3	2 / 1.3
<b>Connecting cable</b>	1 m long, 2 x 0.75 mm <sup>2</sup>	
<b>Direction of rotation</b>	determined by L/R positioning	
<b>Torque (motor / spring) [Nm]</b>	2 (at nominal voltage) / 2	
<b>Angle of rotation:</b>	max. 95°, adjustable 37...100 % with a mechanical end stop	
<b>Swing time (motor / spring) [sec]</b>	40...75 (0...2 Nm) / < 25 bei -20...50 °C	
<b>Service life</b>	60 000 switching operations	
<b>Ingress protection rating</b>	IP42	IP42
<b>Electrical protection class</b>	III low voltage II totally insulated	III low voltage II totally insulated
<b>Operation temperature [°C]</b>	-30...+50	-30...+50
<b>Storage temperature [°C]</b>	-40...+80	-40...+80
<b>Ambient humidity</b>	95 %, no condensation	
<b>Noise level (motor/ spring) [dBA]</b>	50 / ≈ 62	50 / ≈ 62
<b>Maintenance</b>	not required	
<b>Weight [kg]</b>	0.6	0.6

# SFK 20x32

## Hydraulic syphon for condensate drainage

### Features

- The hydraulic syphon kit for water heat exchangers SFK 20x32 is designed for condensate drainage from heat exchangers and coolers in ventilation and air conditioning systems.
- The syphon must be connected to a drain pan pipe  $\varnothing$  18 mm.



### Design

- When the condensate is drained from the ventilation unit, it passes the drain pipe through the flexible PVC hose, the connection coupling and reaches the syphon with the mechanical locking device that does not let sewage system odours out after the hydraulic seal dries out. Then the condensate is moved to the sewage system.
- The SFK 20x32 kit consists of:
  - Coupling 32/32
  - Rubber sleeve 32/20
  - Syphon
  - PVC hose 15x2 of 1000 mm length

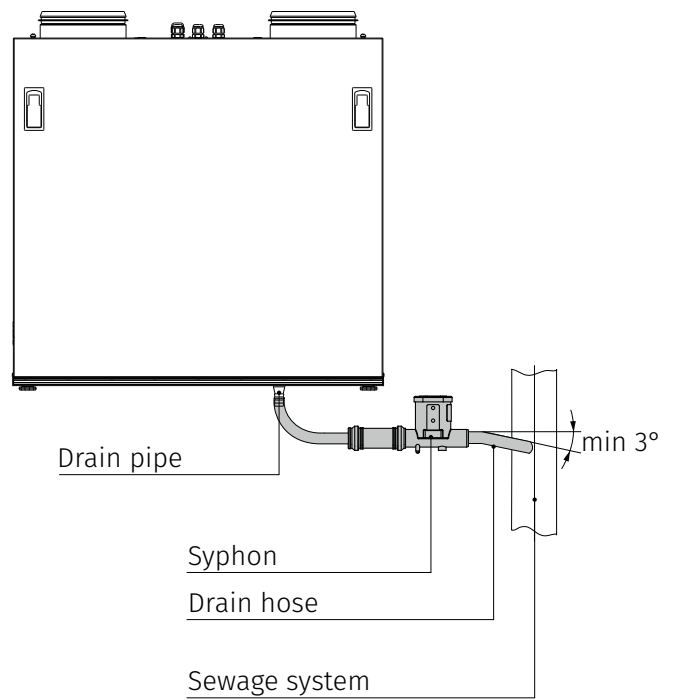

CONDENSATE DRAINAGE

### Overall dimensions [mm]

Model	D	B	L
SFK 20x32	32	103	1000

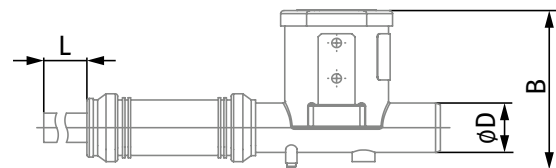











Blauberg Ventilatoren GmbH  
Stäblistraße 6  
81477 Munich, Germany  
HRB 203341  
Tel.: +49 89 78 508 088

[info@blaubergventilatoren.de](mailto:info@blaubergventilatoren.de)  
[www.blaubergventilatoren.de](http://www.blaubergventilatoren.de)

Technical changes reserved.  
Illustrations and texts are non-binding.

04/2024