



SINGLE-ROOM VENTILATION

CONTENTS

Single-room air handling units

	FRESHBOX 60	4
	FRESHBOX 100 WiFi	6
	FRESHBOX 100	12
	FRESHBOX 200 ERV WiFi	18
	CIVIC EC LB	24
	CIVIC EC DB	32

Heat recovery single-room units

	VENTO EXPERT A30 S10 W V.2	40
	VENTO EXPERT A50-1 W V.3	46
	VENTO EXPERT A50-1 S8 W V.3	52
	VENTO EXPERT A100-1 S10 W V.2	58
	VENTO EXPERT DUO A30-1 S10 W V.2	64
	VENTO EXPERT A50-1 PRO V.3	70

Heat recovery single-room units



VENTO EXPERT DUO A30-1 S10 PRO 76



VENTO ECO A50-4 S11 PRO 82



VENTO ECO2 A50-4 S11 PRO 88



VENTO ECO A30-4 S11 PRO 94



VENTO ERGO A50-1 PRO V.3 100



VENTO ERGO A85-1 PRO V.3 106

Wall vents



SOLO A35 S4 PRO R 112



SOLO A35 S4 PRO R V.2 114

Outer ventilation hood mounting from inside



PP 160 116

Control panel



SE VENTO EXPERT W 117

Electric heater



EH FRESHBOX 118

Sensors



CD-1/CD-2

119



DRWQ40200

120



DPWQ30600

121



DPWC11200

122



HR-S

123

FRESHBOX 60

SINGLE-ROOM AIR HANDLING UNITS

Features

- Heat recovery single-room air handling unit for supply and exhaust ventilation.
- Efficient energy-saving single-room ventilation of flats, houses, cottages, social and commercial premises.
- Ideal solution for simple and efficient ventilation of new or refurbished premises.
- Heat recovery minimises ventilation heat losses.
- Controllable air exchange creates individually set microclimate.



Air flow:
up to 60 m³/h
17 l/s



Heat recovery efficiency:
up to 79 %



Design

- The casing is made of polymer coated steel plates, internally filled with 15 mm thermal and sound insulation layer of PE foam.
- The hinged front panel of the casing ensures easy access to the internals for maintenance.
- The unit is powered via an integrated power pulser with a wide range supply voltage range from 100 to 240 V and frequency from 50 to 60 Hz.
- The unit is supplied with a power cord and a plug for connection to power supply.
- Compatible with round Ø 125 mm air ducts.

Motors

- Axial fans with EC motors provide air supply and air extract.
- EC motor technologies meet the latest engineering demands for saving energy and for high-efficient ventilation.
- Low energy demand due to implemented EC technologies.
- The fan motors are equipped with a built-in thermal overheating protection and ball bearings for a long service life.

Mounting

- Install one **FRESHBOX 60** unit in each room requiring ventilation.
- One unit is able to provide efficient ventilation in a premise with area up to 35 m².
- Surface wall mounting on an outside wall from inside the premise.
- Suitable for wall thickness from 100 up to 500 mm.
- The hole spacing for Ø 125 mm air ducts with a master plate included into the delivery set.
- Install the **AH FRESHBOX 60** outer hood (separate order, ref. accessories) on the outer wall.

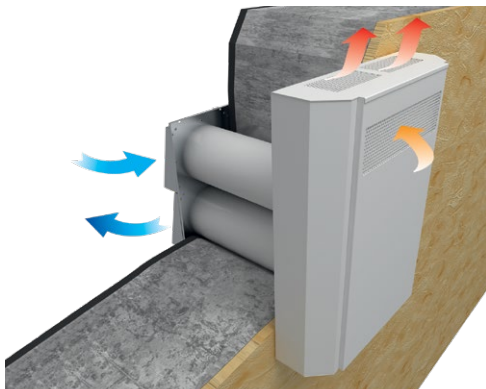

Heat recovery

- The unit is equipped with a plate counter-flow plastic heat exchanger with a large surface area and high heat recovery efficiency.
- Heat recovery efficiency reaches 79 %.
- The air flows are fully separated within the heat exchanger. Odours and contaminants contained in the extract air are not transferred to the supply air flow.
- Heat recovery is based on extract air heat recovery for warming up of supply air. Extract air transfers most of its heat to the intake air flow. Heat recovery reduces heat losses in cold seasons. In summer the heat exchanger performs reverse and transfers a part of the accumulated coolness from the cooled extract air for cooling down of the intake air. This contributes to better performance of the air conditioner in ventilated premises.
- The integrated freezing protection system switches the supply fan off in the cold season in case of a freezing danger communicated by the temperature sensor to enable warming of the heat exchanger with the warm extract air flow. When a freezing danger is over the supply fan turns on and the unit reverts to the standard operation mode.

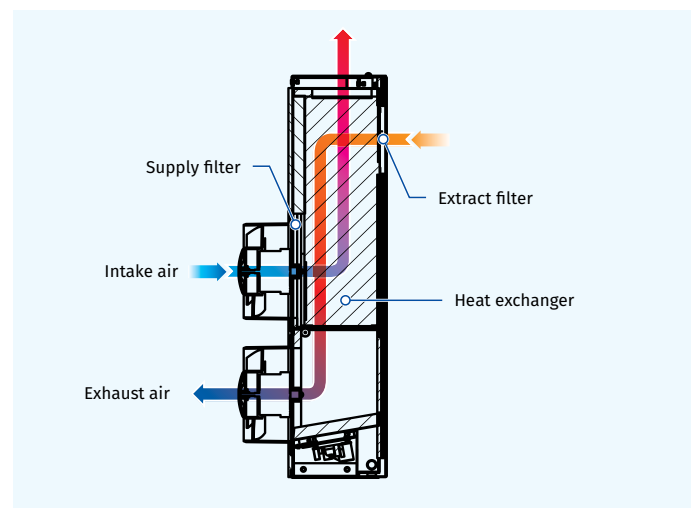

Air filtration

- Supply and extract air cleaning with two G4 filters.
- The filters ensure fresh air supply, free of dust, insects and prevent contamination of the unit components.

Control

- The unit is operated with an external sensor speed switch that enables switching the unit on/off as well as setting low, medium or high speed mode.

FRESHBOX 60

SINGLE-ROOM AIR HANDLING UNITS

Technical data

Parameters	FRESHBOX 60		
	I	II	III
Speed			
Voltage [V / 50 (60) Hz]	1~ 100-240		
Power [W]	4.2	9.6	15.4
Current [A]	0.02	0.04	0.07
Maximum air flow [m³/h (l/s)]	30 (8)	45 (13)	60 (17)
RPM [min⁻¹]	1165	1720	2685
Noise level [dBA]	22	25	29
Transported air temperature [°C]	-20...+40		
Filter: extract/supply	G4		
Heat recovery efficiency [%]	79	74	70
Heat exchanger type	counter-flow		
Heat exchanger material	polystyrene		
SEC Class	B		
Weight [kg]	10.3		

ENERGIA - ЕНЕРГИЈА - ENERTEIA - ENERGIA - ENERGI - ENERGIE - ENERGI
2020 1254/2014

Overall dimensions [mm]

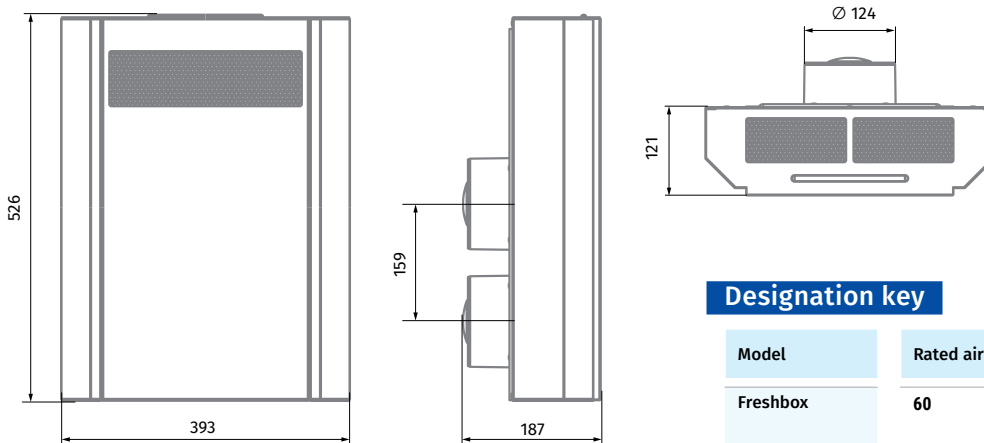

Designation key

Model	Rated air flow [m³/h]
Freshbox	60

Accessories

Name	Description
MS1 FRESHBOX 60	<p>Mounting kit: • cardboard master plate (2 items) • plastic Ø 125 mm, 500 mm long air duct (2 items)</p>
MS2 FRESHBOX 60	<p>Mounting kit: • cardboard master plate (1 item) • plastic Ø 125 mm, 500 mm long air duct (2 items) • stainless steel outer hood</p>
AH FRESHBOX 60	<p>Stainless steel outer hood</p>
FP 216x147x10 G4	<p>G4 supply panel filter</p>
FP 279x88x10 G4	<p>G4 extract panel filter</p>

FRESHBOX 100 WiFi

SINGLE-ROOM AIR HANDLING UNITS

Features

- Efficient solution for supply and exhaust ventilation of enclosed spaces.
- Electric preheater or reheater modification available for cold climate conditions.
- Heat exchanger with an enthalpy membrane modification available for humid and hot climate conditions.
- Low-energy EC motors.
- Silent operation.
- Upgradeable with an exhaust duct to provide air extraction from the bathroom.
- Easy installation.
- Compact size.
- Controlled by Android or iOS smartphone or tablet over Wi-Fi.



Air flow:
up to 100 m³/h
28 l/s



Heat recovery efficiency:
up to 98 %



Design

- Polymer coated metal casing decorated with an acrylic front panel. Heat and noise insulation is ensured by a layer of 10 mm cellular synthetic rubber.
- The front panel provides convenient access for filter maintenance and has a lock for extra security.
- The unit has two Ø 100 mm pipes for fresh air intake and stale air extraction outside. The third Ø 100 mm pipe (included in the scope of delivery) can be additionally fitted to the unit to connect the exhaust air duct from the bathroom.

Motors

- The units feature efficient electronically commutated (EC) motors with an external rotor and impellers with forward curved blades. These state-of-the-art motors are the most advanced solution in energy efficiency today.
- EC motors are characterised with high performance and optimum control across the entire speed range. In addition to that the efficiency of electronically commutated motors reaches very impressive levels of up to 90 %.

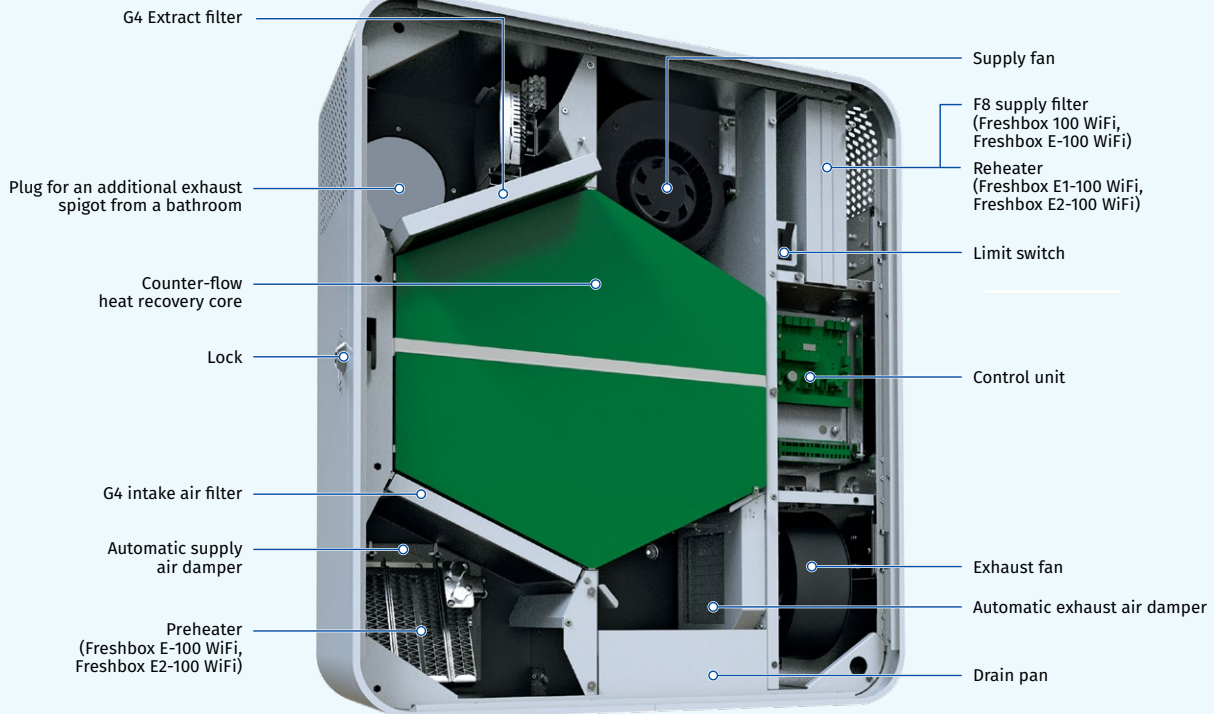

Designation key

Series	Heater	Rated air flow [m³/h]	Heat exchanger core type	Control
Freshbox	-: no heater E: preheating E1: reheating E2: preheating and reheating	- 100	-: heat recovery ERV: energy recovery	WiFi: sensor control panel and Wi-Fi communication

FRESHBOX 100 WiFi

SINGLE-ROOM AIR HANDLING UNITS

Air dampers

- o The unit is equipped with supply and exhaust air dampers which activate automatically to prevent drafts while the unit is off.

Air filtration

- o **Freshbox 100 WiFi, Freshbox E-100 WiFi:** supply air cleaning is provided by the G4 and F8 filters. To meet more stringent air purity requirements the F8 filter can be replaced with an H13 or F8 carbon filter (purchased separately). Exhaust air is cleaned by the filter G4.
- o **Freshbox E1-100 WiFi, Freshbox E2-100 WiFi:** the built-in G4 supply filter and G4 extract filter provide air filtration.

Operating principle

- o **The cold outdoor air** passes through the filters and the heat exchanger and then is delivered to the serviced space by the supply centrifugal fan.
- o **Warm polluted air from the premise** flows through the filter and the heat exchanger and is exhausted outside with an extract centrifugal fan through an air duct in the wall.
- o **The supply and exhaust air** flows are fully separated which helps eliminate the possibility of odour or microbial transfer between the streams.

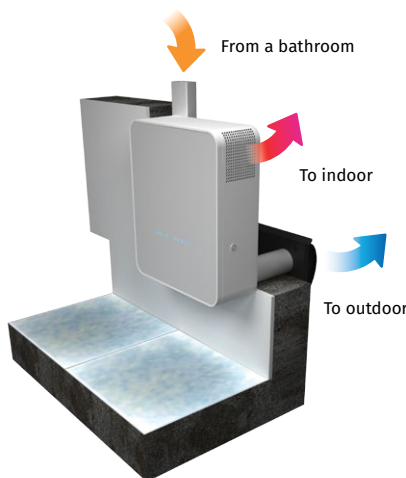
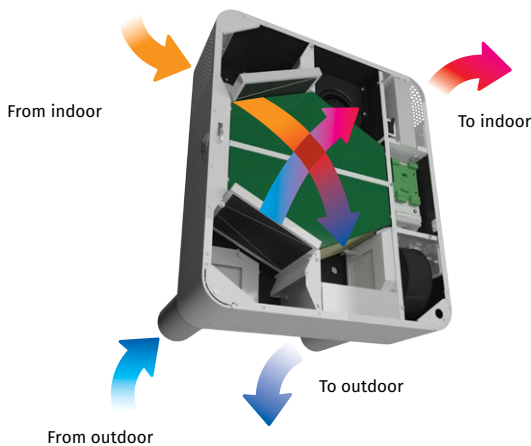

Operating principle with extra spigot for bathroom exhaust ventilation

Heat and energy recovery

- o The **Freshbox 100 WiFi** units are equipped with a counter-flow heat recovery core with a polystyrene core.
 - **In the cold season** the exhaust air heat is captured and transferred to the supply air stream which reduces the ventilation-generated heat losses. Some condensate may form during heat recovery. The condensate is collected in the drain pan and is removed from the exhaust air duct.
 - **In the warm season** the intake air heat is transferred to the extract air stream. This allows for a considerable reduction of the supply air temperature which, in turn, reduces the air conditioning load.
- o The **Freshbox 100 ERV WiFi** units are equipped with a counter-flow energy recovery core with an enthalpy membrane at the core.
 - **In the cold season** the exhaust air heat and moisture are transferred to the supply air stream through the enthalpy membrane reducing the heat losses through ventilation.
 - **In warm season** the heat and humidity of the outdoor air is absorbed by extract air flow through the enthalpy membrane. This way the supply air temperature and humidity decreases and heat recovery reduces operation loads for the air conditioner.

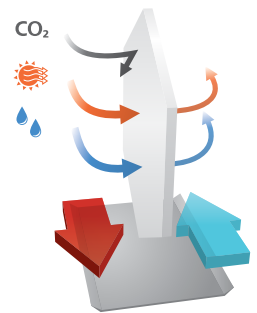
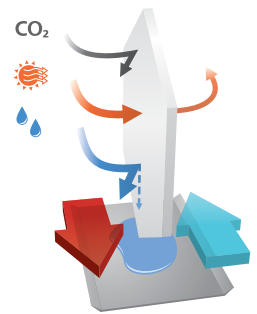

Heaters

PREHEATING

- o **Freshbox E-100 WiFi, Freshbox E2-100 WiFi** units are equipped with an electric preheater for freeze protection of the heat exchanger.

REHEATING

- o **Freshbox E1-100 WiFi, Freshbox E2-100 WiFi** units feature an electric reheater to raise the supply air temperature as necessary.

Freeze protection

- o **Freshbox 100 WiFi** features an exhaust air temperature sensor downstream of the heat exchanger which disables the supply fan to let the warm extract air warm up the heat exchanger. After that the supply fan is turned on and the unit reverts to the normal operation mode.
- o Overheating protection for **Freshbox E-100 WiFi** and **Freshbox E2-100 WiFi** is implemented with a preheater.

FRESHBOX 100 WiFi

SINGLE-ROOM AIR HANDLING UNITS

Control

- The unit is equipped with a control panel.
- The remote control is supplied as standard
- Wi-Fi communication.



AUTOMATIC FUNCTIONS

	Freshbox 100 WiFi Freshbox E-100 WiFi	Freshbox E1-100 WiFi Freshbox E2-100 WiFi
Speed selection	•	•
Filter replacement indication	•	•
Alarm indication	•	•
Speed setup	•	•
Timer	•	•
Week scheduler	•	•
Reheater enabled/disabled		•
Supply air temperature setup		•
Control with the mobile application Android / iOS	•	•



Download
Android application
Blauberg Freshbox



Download
iOS application
Blauberg Freshbox

REMOTE CONTROL

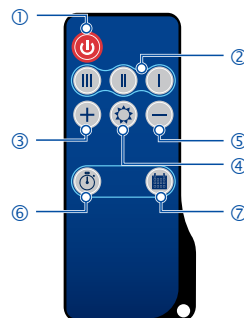

- 1 Turning unit on/off
- 2 Speed selection (Min/Mid/Max)
- 3 Increasing temperature set point for the reheater (available for the models with a reheater)
- 4 Turning reheater on/off (available for the models with a reheater)
- 5 Decreasing temperature set point for the reheater (available for the models with a reheater)
- 6 Turning timer on/off
- 7 Activation/deactivation of the scheduled operation mode

CONTROL PANEL

- ON/OFF button
- Speed changeover (down)
- Speed changeover (up)
- Weekly schedule
- Connection to WiFi
- Filter replacement indication
- Alarm indication

Technical data

Parameters	Freshbox 100 WiFi					Freshbox 100 ERV WiFi					Freshbox E-100 WiFi					Freshbox E-100 ERV WiFi				
	I	II	III	IV	V	I	II	III	IV	V	I	II	III	IV	V	I	II	III	IV	V
Speed																				
Voltage [V / 50 (60) Hz]	1~ 110-240										1~ 230									
Max. power without heater(s) [W]	20	23	29	37	53	20	23	29	37	53	20	23	29	37	53	20	23	29	37	53
Preheater power consumption [W]											700					700				
Reheater power consumption [W]																				
Max. current consumption without heater(s) [A]	0.4																			
Max. current consumption with heater(s) [A]											3.6					3.6				
Maximum air flow [m³/h (l/s)]	30 (8)	44 (12)	60 (17)	75 (21)	100 (28)	30 (8)	44 (12)	60 (17)	75 (21)	100 (28)	30 (8)	44 (12)	60 (17)	75 (21)	100 (28)	30 (8)	44 (12)	60 (17)	75 (21)	100 (28)
RPM [min⁻¹]	max 2200																			
Sound pressure level at 3 m [dBA]	13	20	27	33	39	13	20	27	33	39	13	20	27	33	39	13	20	27	33	39
Transported air temperature [°C]	-20...+40																			
Casing material	polymer coated steel																			
Insulation thickness [mm]	10																			
Extract filter	G4																			
Supply filter	G4 + F8 (Option: F8 Carbon; H13)																			
Connected air duct diameter [mm]	100																			
Weight [kg]	31																			
Heat recovery efficiency [%]*	98	95	92	90	89	96	94	89	85	83	98	95	92	90	89	96	94	89	85	83
Heat recovery core type	counter-flow																			
Heat exchanger material	polystyrene					enthalpic membrane					polystyrene					enthalpic membrane				
SEC class	A																			

*Heat recovery efficiency is specified in compliance with EN 13141-8.

FRESHBOX 100 WiFi

SINGLE-ROOM AIR HANDLING UNITS

Parameters	Freshbox E1-100 WiFi					Freshbox E1-100 ERV WiFi					Freshbox E2-100 WiFi					Freshbox E2-100 ERV WiFi				
	I	II	III	IV	V	I	II	III	IV	V	I	II	III	IV	V	I	II	III	IV	V
Speed																				
Voltage [V / 50 (60) Hz]	1~230																			
Max. power without heater(s) [W]	20	23	29	37	53	20	23	29	37	53	20	23	29	37	53	20	23	29	37	53
Preheater power consumption [W]	-					-					700					700				
Reheater power consumption [W]	350																			
Max. current consumption without heater(s) [A]	0.4																			
Max. current consumption with heater(s) [A]	1.94										5.2									
Maximum air flow [m³/h (l/s)]	30 (8)	44 (12)	60 (17)	75 (21)	100 (28)	30 (8)	44 (12)	60 (17)	75 (21)	100 (28)	30 (8)	44 (12)	60 (17)	75 (21)	100 (28)	30 (8)	44 (12)	60 (17)	75 (21)	100 (28)
RPM [min⁻¹]	max 2200																			
Sound pressure level at 3 m [dBA]	13	20	27	33	39	13	20	27	33	39	13	20	27	33	39	13	20	27	33	39
Transported air temperature [°C]	-20...+40																			
Casing material	polymer coated steel																			
Insulation thickness [mm]	10																			
Extract filter	G4																			
Supply filter	G4																			
Connected air duct diameter [mm]	100																			
Weight [kg]	31																			
Heat recovery efficiency [%]*	98	95	92	90	89	96	94	89	85	83	98	95	92	90	89	96	94	89	85	83
Heat recovery core type	counter-flow																			
Heat exchanger material	polystyrene					enthalpic membrane					polystyrene					enthalpic membrane				
SEC class	A																			

*Heat recovery efficiency is specified in compliance with EN 13141-8.

Sound-power level, A - weighted	Total	Octave frequency band [Hz]								Sound pressure level at 3 m, A-filter applied	Sound pressure level at 1 m, A-filter applied
		63	125	250	500	1000	2000	4000	8000		
L _{WA} to environment [dBA]	49	45	40	44	38	33	29	27	22	28	38

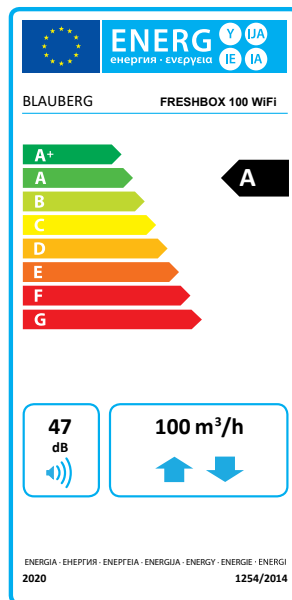
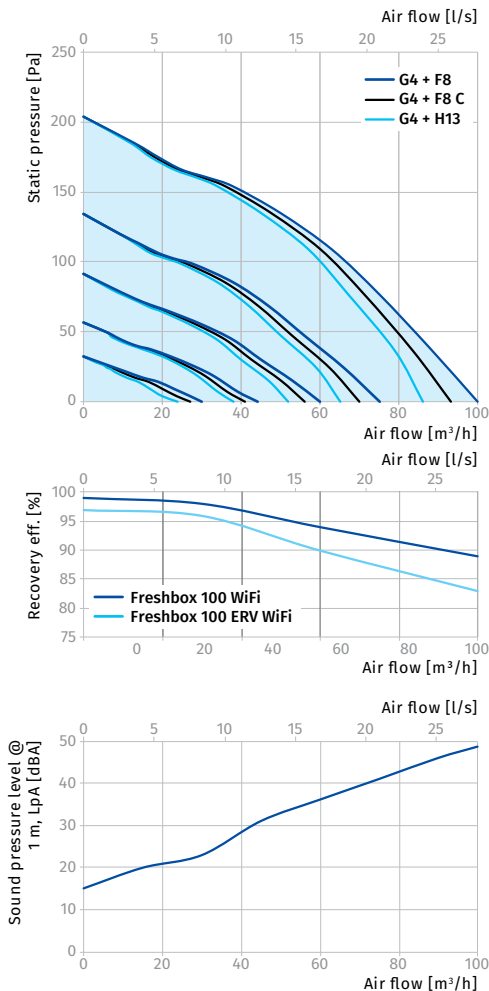

Overall dimensions [mm]

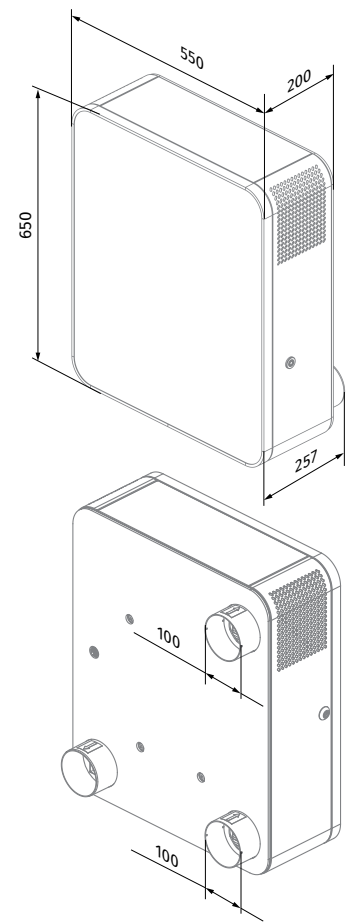

FRESHBOX 100 WiFi

SINGLE-ROOM AIR HANDLING UNITS

Mounting example

Each space requiring ventilation is equipped with one or several Freshbox 100 WiFi units. A single unit is capable to ensure efficient ventilation in spaces with floor area up to 75 m².

Freshbox 100 WiFi units can be upgraded with a bathroom exhaust air duct. To enable such a configuration the units can be additionally equipped with the optional Ø 100 mm spigot (supplied as standard).

FRESHBOX 100 WiFi DEPLOYMENT IN A COMPACT RESIDENTIAL SPACE

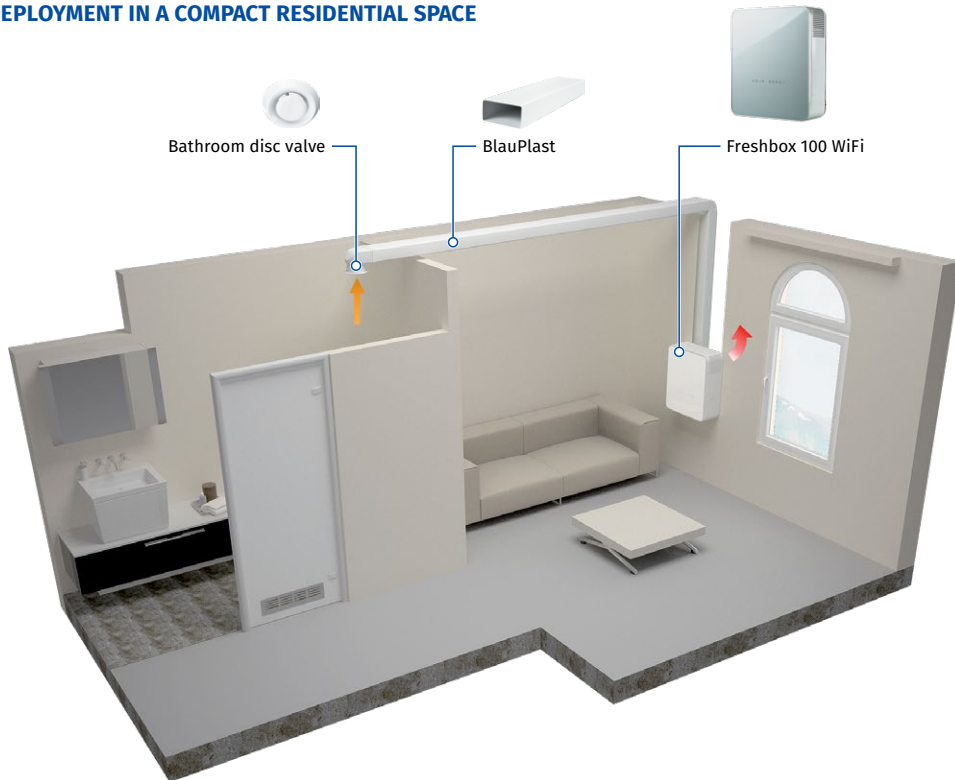

FRESHBOX 100 WiFi MOUNTING EXAMPLE IN THE OFFICE

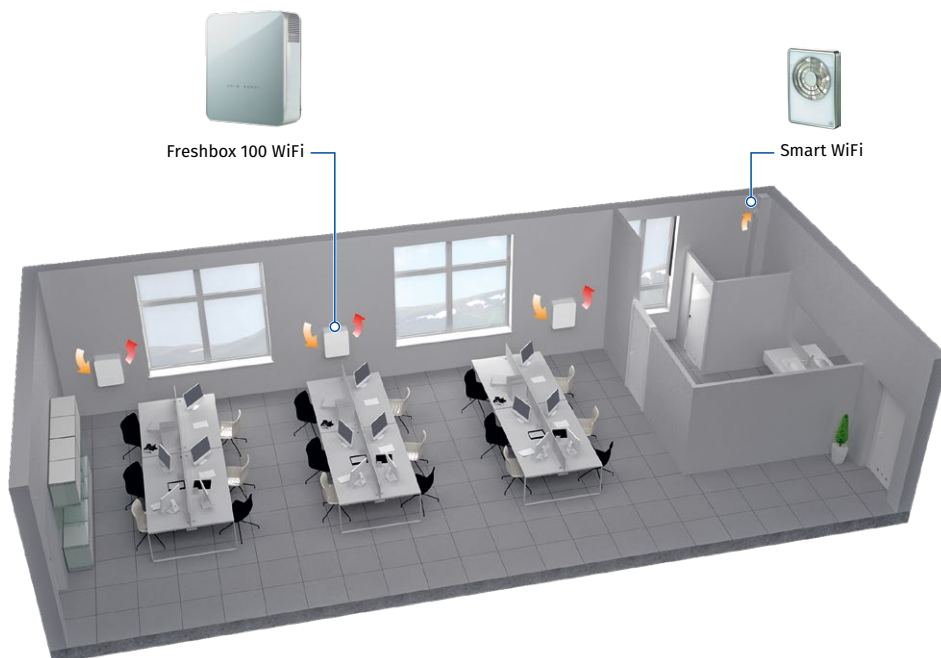

FRESHBOX 100 WiFi

SINGLE-ROOM AIR HANDLING UNITS

Accessories

Name		Description
MS Freshbox 100 chrome		Mounting kit: • Two \varnothing 100 mm air ducts, 500 mm long • Ventilation outer hood made of polished steel • Cardboard template
MS Freshbox 100 white		Mounting kit: • Two \varnothing 100 mm air ducts, 500 mm long • Ventilation outer hood, painted white • Cardboard template
AH Freshbox 100 chrome		Ventilation outer hood made of polished steel
AH Freshbox 100 white		Ventilation outer hood, painted white
EH Freshbox 100		Heater to prevent condensate freezing in the drain pipe and outer ventilation hood
FP 193x158x18 G4 PPI		G4 panel filter
FP 193x158x47 F8		F8 panel filter
FP 193x158x47 F8 C		F8 carbon panel filter
FP 193x158x47 H13		H13 HEPA panel filter
HR-S		Humidity sensor
CD-1		CO ₂ sensor with LED CO ₂ indication and a sensor button for operation mode selection
CD-2		CO ₂ sensor

FRESHBOX 100

SINGLE-ROOM AIR HANDLING UNITS

Features

- Efficient solution for supply and exhaust ventilation of enclosed spaces.
- Electric preheating or reheating is available for cold climate conditions.
- Units with enthalpy heat exchangers are available for use in hot and wet climates.
- Low-energy EC motors.
- Silent operation.
- Supply air purification ensured by two built-in G4 and F8 filters (optionally F8 C and H13).
- Upgradeable with an exhaust duct to provide air extraction from the bathroom.
- Easy installation.
- Compact size.



Air flow:
up to 100 m³/h
28 l/s



Heat recovery efficiency:
up to 98 %



Design

- Polymer coated metal casing decorated with an acrylic front panel. Heat and noise insulation is ensured by a layer of 10 mm cellular synthetic rubber.
- The front panel provides convenient access for filter maintenance and has a lock for extra security.
- The unit has two Ø 100 mm pipes for fresh air intake and stale air extraction outside. The third Ø 100 mm pipe (included in the scope of delivery) can be additionally fitted to the unit to connect the exhaust air duct from the bathroom.

Motors

- The units feature efficient electronically commutated (EC) motors with an external rotor and impellers with forward curved blades. These state-of-the-art motors are the most advanced solution in energy efficiency today.
- EC motors are characterised with high performance and optimum control across the entire speed range. In addition to that the efficiency of electronically commutated motors reaches very impressive levels of up to 90 %.

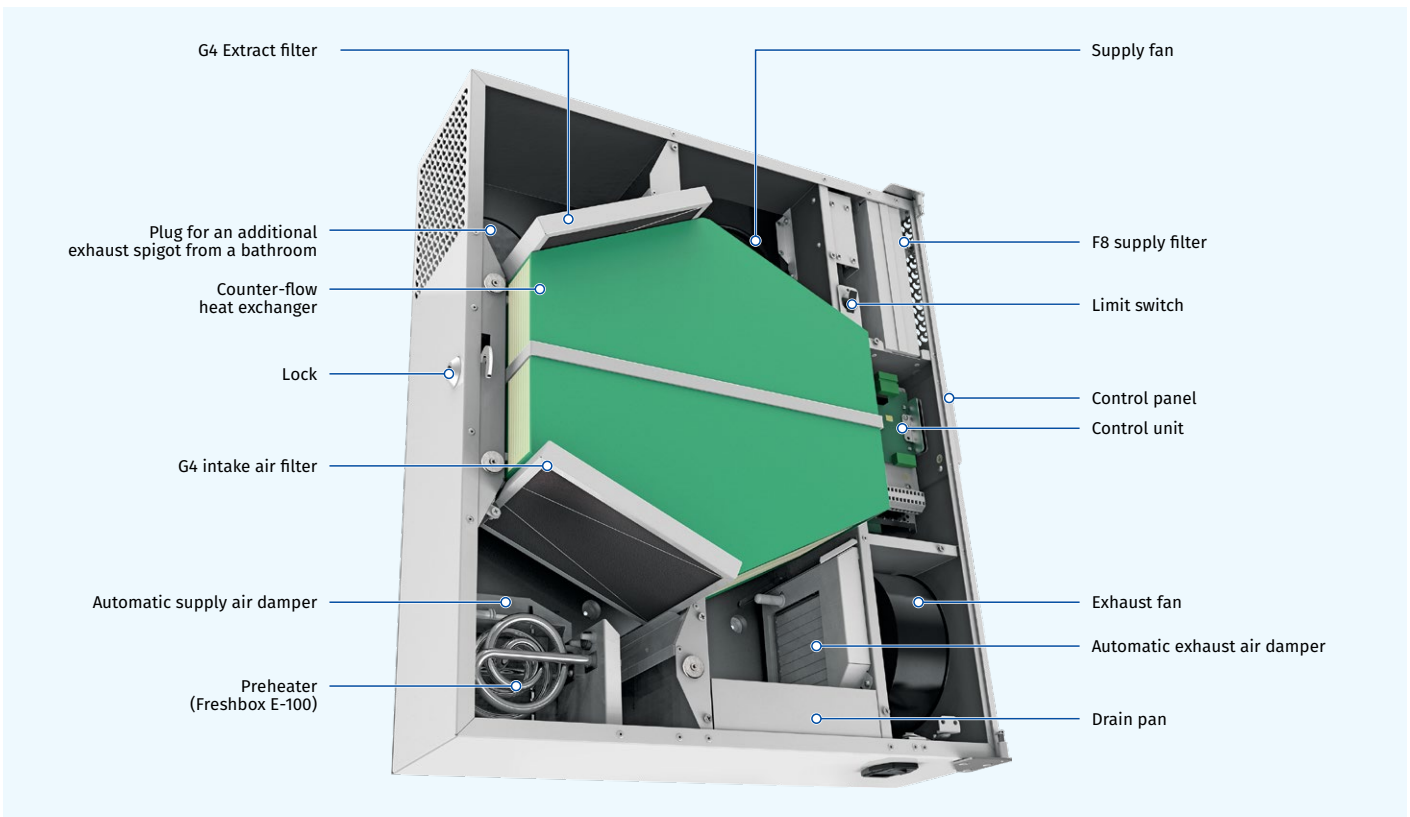

Designation key

Model	Heater	Rated air flow [m ³ /h]	Heat exchanger type	Colour
Freshbox	_ : no heater E: preheater	- 100	_ : heat recovery ERV: energy recovery	_ : white casing Black: black casing

FRESHBOX 100

SINGLE-ROOM AIR HANDLING UNITS

Air dampers

- The unit is equipped with supply and exhaust air dampers which activate automatically to prevent drafts while the unit is off.

Air filtration

- Supply air cleaning is provided by the G4 and F8 panel filters (PM2.5 > 75 %). To meet more stringent air purity requirements the F8 filter can be replaced with an H13 (PM2.5 > 99 %) (purchased separately). Exhaust air is cleaned by the panel filter G4.

Heaters

PREHEATING

- Freshbox E-100** units are equipped with an electric preheater which protects the heat exchanger from freezing.

HEATER FOR CONDENSATE FREEZE PROTECTION

- Operation in a cold climate may result in condensate freezing in the exhaust air duct and the external hood. Therefore, it is recommended to install the **EH Freshbox 100** (optional) heater (purchased separately) to prevent icing.

Operating principle

- The cold outdoor air** passes through the filters and the heat exchanger and then is delivered to the serviced space by the supply centrifugal fan.
- Warm polluted air from the premise** flows through the filter and the heat exchanger and is exhausted outside with an extract centrifugal fan through an air duct in the wall.
- The supply and exhaust air** flows are fully separated which helps eliminate the possibility of odour or microbial transfer between the streams.

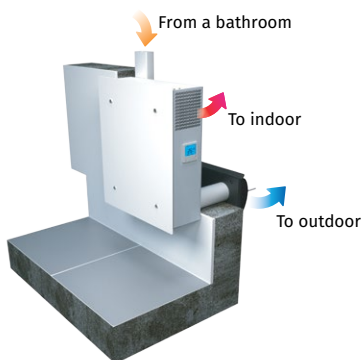
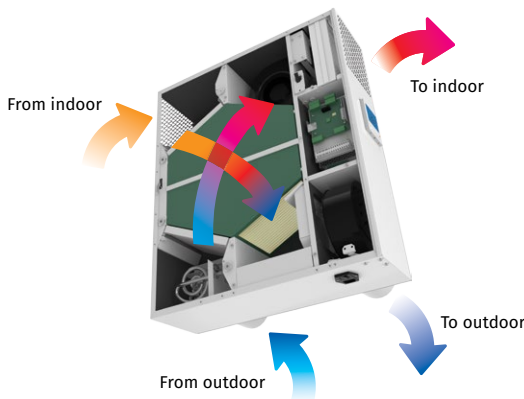

Operating principle with extra spigot for bathroom exhaust ventilation

Heat exchanger

- The **Freshbox 100** units are equipped with a counter-flow heat exchanger with a polystyrene core.

- In the cold season** the exhaust air heat is captured and transferred to the supply air stream which reduces the ventilation-generated heat losses. Some condensate may form during heat recovery. The condensate is collected in the drain pan and is removed from the exhaust air duct.

- In the warm season** the intake air heat is transferred to the extract air stream. This allows for a considerable reduction of the supply air temperature which, in turn, reduces the air conditioning load.

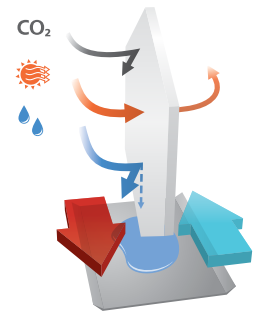

- The **Freshbox 100 ERV** units are equipped with a counter-flow heat exchanger with an enthalpy membrane at the core.

- In the cold season** the exhaust air heat and moisture are transferred to the supply air stream through the enthalpy membrane reducing the heat losses through ventilation.

- In warm season** the heat and humidity of the outdoor air is absorbed by extract air flow through the enthalpy membrane. This way the supply air temperature and humidity decreases and heat recovery reduces operation loads for the air conditioner.

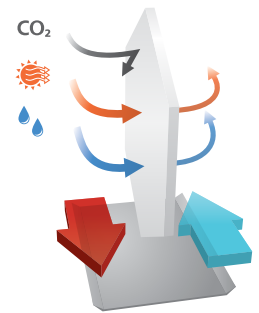

Control

- The unit is equipped with a control panel.
- The remote control is supplied as standard.

FUNCTIONS

	Freshbox 100	Freshbox E-100
Speed changeover	•	•
Filter replacement indication	•	•
Alarm indication	•	•
Speed setting	•	•
Timer	•	•
Weekly schedule	•	•
Preheating enabled/disabled		•

FREEZE PROTECTION

- There are two types of freeze protection available to protect the heat exchangers in the cold season.
- Freshbox 100** features an exhaust air temperature sensor downstream of the heat exchanger which disables the supply fan to let the warm extract air warm up the heat exchanger. After that the supply fan is turned on and the unit reverts to the normal operation mode.
- The **Freshbox E-100** units are equipped with an electric preheater which warms up the supply air upstream of the heat exchanger to prevent it from freezing.
- These features ensure a continuous balanced air exchange regardless of ambient air temperature variations.

FRESHBOX 100

SINGLE-ROOM AIR HANDLING UNITS

Technical data

Parameters	Freshbox 100			Freshbox 100 ERV			Freshbox E-100			Freshbox E-100 ERV		
	1	2	3	1	2	3	1	2	3	1	2	3
Speed												
Voltage [V / 50-60 Hz]	1~ 110-240			1~ 110-240			1~ 230			1~ 230		
Max. unit power without electric heater [W]	12	21	45	12	21	45	12	21	45	12	21	45
Integrated electric preheater power [W]	-			-			700			700		
Integrated electric reheater power [W]	-			-			-			-		
Max. unit current without electric heater [A]	0.4			0.4			0.4			0.4		
Max. unit current with electric heater [A]	-			-			3.6			3.6		
Maximum air flow [m ³ /h (l/s)]	30 (8)	60 (17)	100 (28)	30 (8)	60 (17)	100 (28)	30 (8)	60 (17)	100 (28)	30 (8)	60 (17)	100 (28)
RPM [min ⁻¹]	2200			2200			2200			2200		
Sound pressure level at 3 m distance [dBA]	13	27	39	13	27	39	13	27	39	13	27	39
Max. operating temperature [°C]	-20...+40			-20...+40			-20...+40			-20...+40		
Case material	polymer coated steel			polymer coated steel			polymer coated steel			polymer coated steel		
Insulation [mm]	10			10			10			10		
Extract filter	G4			G4			G4			G4		
Supply filter	G4, F8 (Option: F8 C, H13)			G4, F8 (Option: F8 C, H13)			G4, F8 (Option: F8 C, H13)			G4, F8 (Option: F8 C, H13)		
Connected air duct diameter [mm]	100			100			100			100		
Weight [kg]	31			31			31			31		
Heat recovery efficiency [%] *	98	92	89	96	89	83	98	92	89	90	86	83
Heat exchanger type	counter-flow			counter-flow			counter-flow			counter-flow		
Heat exchanger material	polystyrene			enthalpic membrane			polystyrene			enthalpic membrane		
SEC class	A			A			A			A		

*Heat recovery efficiency is specified in compliance with EN 13141-8.

Sound-power level, A - weighted	Total	Octave frequency band [Hz]								Sound pressure level at 3 m, A-filter applied	Sound pressure level at 1 m, A-filter applied
		63	125	250	500	1000	2000	4000	8000		
L _{WA} to environment [dBA]	49	45	40	44	38	33	29	27	22	28	38

FRESHBOX 100

SINGLE-ROOM AIR HANDLING UNITS

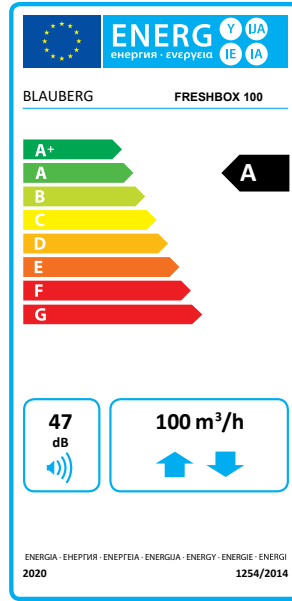
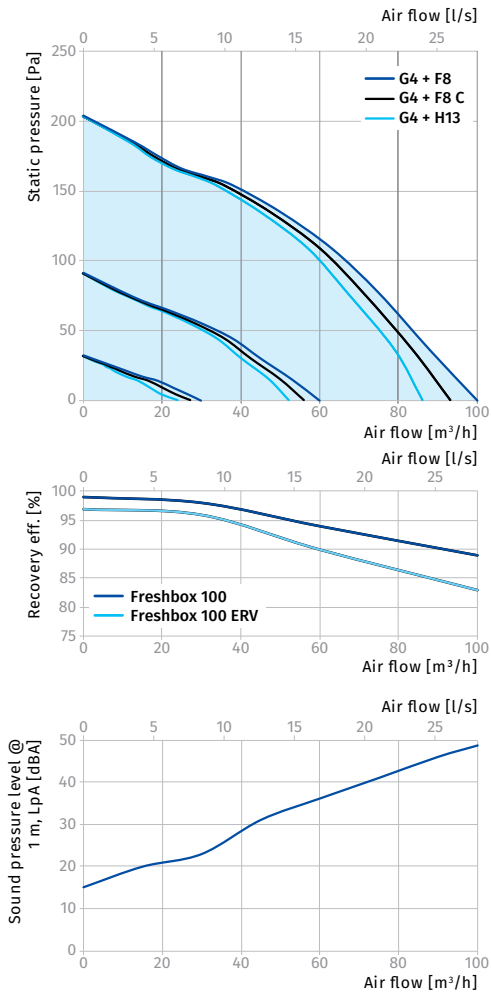

Overall dimensions [mm]

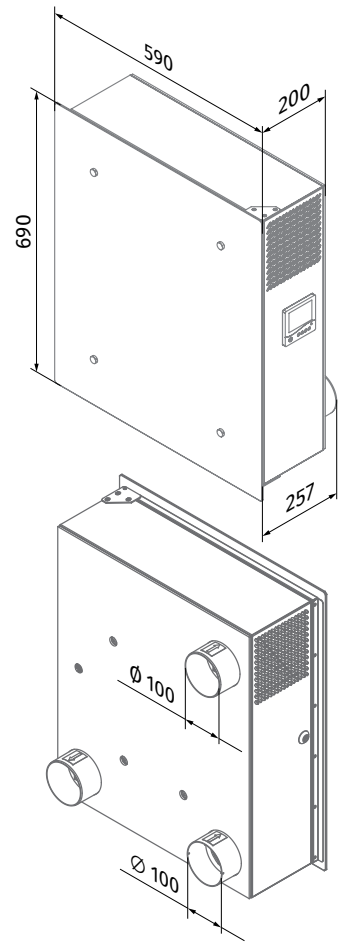

FRESHBOX 100

SINGLE-ROOM AIR HANDLING UNITS

Mounting example

Each space requiring ventilation is equipped with one or several Freshbox 100 units. A single unit is capable to ensure efficient ventilation in spaces with floor area up to 75 m².

Freshbox 100 units can be upgraded with a bathroom exhaust air duct. To enable such a configuration the units can be additionally equipped with the optional Ø 100 mm spigot (supplied as standard).

FRESHBOX 100 DEPLOYMENT IN A COMPACT RESIDENTIAL SPACE

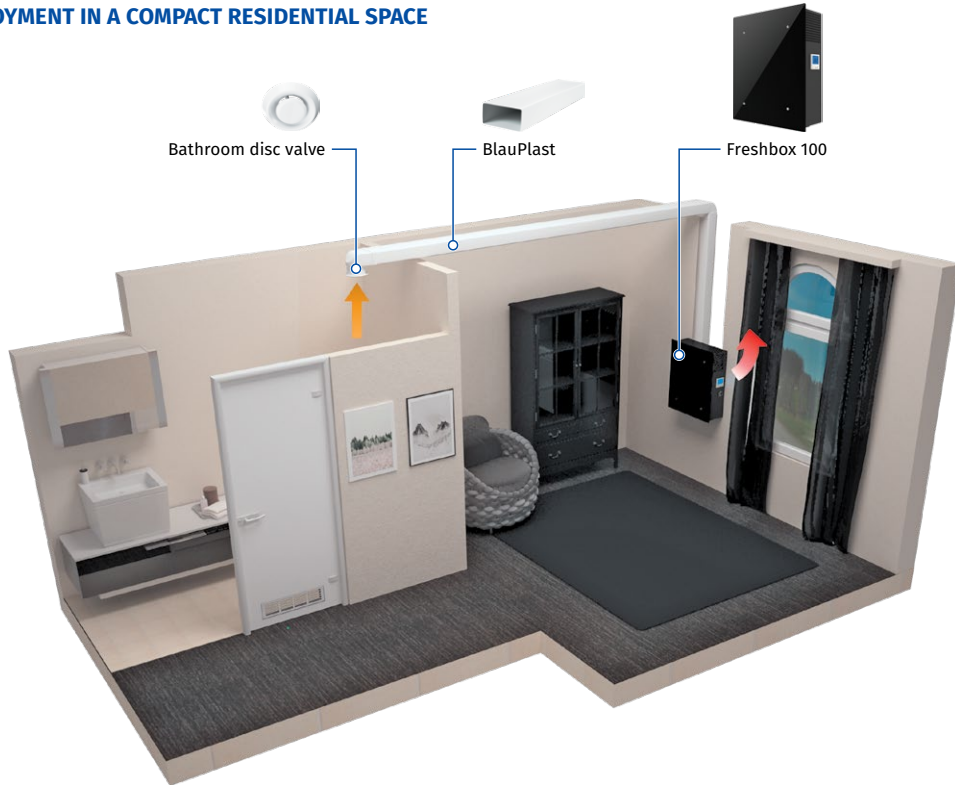

FRESHBOX 100 MOUNTING EXAMPLE IN THE OFFICE

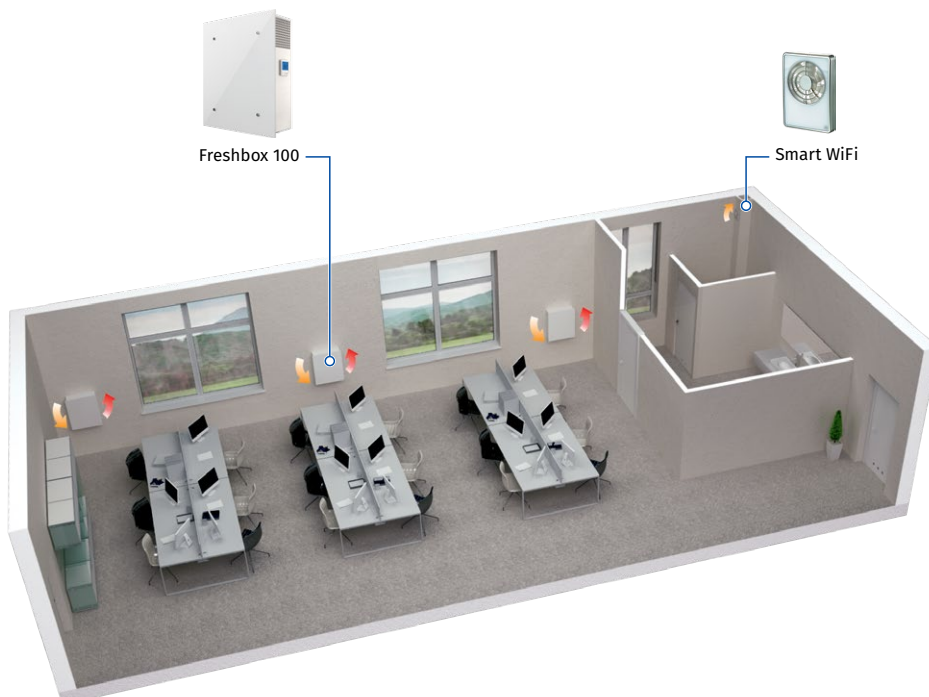

FRESHBOX 100

SINGLE-ROOM AIR HANDLING UNITS

Accessories

Name		Description
MS Freshbox 100 chrome		Mounting kit: • Two Ø 100 mm air ducts, 500 mm long • Ventilation outer hood made of polished steel • Cardboard template
MS Freshbox 100 white		Mounting kit: • Two Ø 100 mm air ducts, 500 mm long • Ventilation outer hood, painted white • Cardboard template
AH Freshbox 100 chrome		Ventilation outer hood made of polished steel
AH Freshbox 100 white		Ventilation outer hood, painted white
EH Freshbox 100		Heater to prevent condensate freezing in the drain pipe and outer ventilation hood
FP 193x158x18 G4 PPI		G4 filter
FP 193x158x47 F8		F8 filter
FP 193x158x47 F8 C		F8 carbon filter
FP 193x158x47 H13		H13 HEPA filter
HR-S		Humidity sensor
CD-1		CO ₂ sensor with LED CO ₂ indication and a sensor button for operation mode selection
CD-2		CO ₂ sensor

FRESHBOX 200 ERV WiFi

SINGLE-ROOM AIR HANDLING UNITS

Features

- Efficient solution for supply and exhaust ventilation of enclosed spaces.
- EC fans with low energy consumption.
- Supply air cleaning is provided by the G4 and F7 filters. Additional air purification due to recirculation. H13 filter is available as an option.
- Upgradeable with an exhaust duct to provide air extraction from the bathroom.
- Easy installation.
- Compact size.
- Controlled by Android or iOS smartphone or tablet over Wi-Fi.



Air flow:
up to 200 m³/h
56 l/s



Heat recovery efficiency:
up to 85 %



Design

- The casing is made of polymer coated steel plates.
- The front panel provides convenient access for filter maintenance and has a lock for extra security.
- The unit has two Ø 100 mm pipes for fresh air intake and stale air extraction outside. The third Ø 100 mm pipe (included in the scope of delivery) can be additionally fitted to the unit to connect the exhaust air duct from the bathroom.
- Available modifications with an integrated preheater and reheater for cold climate applications.

Motors

- The units feature efficient electronically commutated (EC) motors with an external rotor and impellers with forward curved blades. These state-of-the-art motors are the most advanced solution in energy efficiency today.
- EC motors are characterised with high performance and optimum control across the entire speed range. In addition to that the efficiency of electronically commutated motors reaches very impressive levels of up to 90 %.

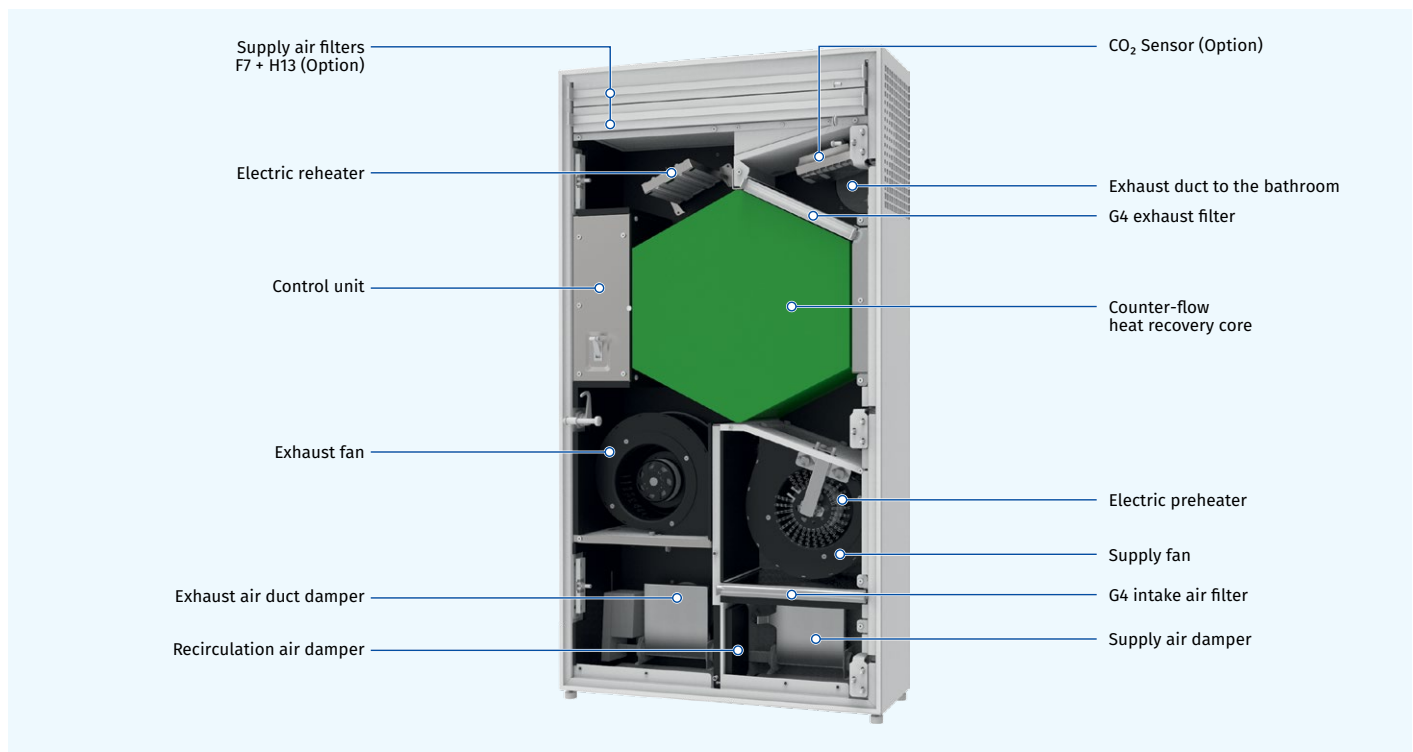

Designation key

Model	Heater	Rated air flow [m ³ /h]	Heat exchanger type	Control
Freshbox	_: no heater E: preheating E1: reheating E2: preheating + reheating	- 200	ERV: energy recovery	WiFi: sensor control panel and Wi-Fi communication

FRESHBOX 200 ERV WiFi

SINGLE-ROOM AIR HANDLING UNITS

Air dampers

- o The unit is equipped with supply and exhaust air dampers which activate automatically to prevent drafts while the unit is off.

Air filtration

- o Supply air cleaning is provided by the G4 and F7 filters. To meet more stringent air purity requirements the F7 filter can be replaced with an H13 Filter (purchased separately).
- o Exhaust air is cleaned by the panel filter G4.

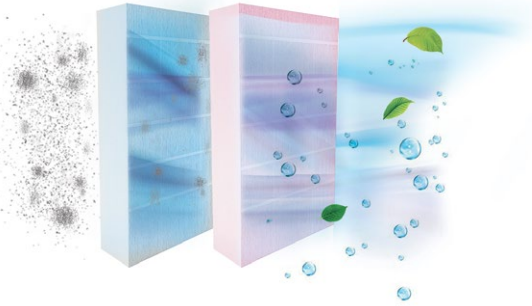

Heaters

PREHEATING

- o **Freshbox E-200 ERV WiFi, Freshbox E2-200 ERV WiFi** units are equipped with an electric preheater for freeze protection of the heat exchanger.

REHEATING

- o **Freshbox E1-200 ERV WiFi, Freshbox E2-200 ERV WiFi** units feature an electric reheater to raise the supply air temperature as necessary.

Freeze protection

- o The **Freshbox 200 ERV WiFi** features an exhaust air temperature sensor downstream of the heat exchanger which disables the supply fan to let the warm extract air warm up the heat exchanger. Then the supply fan is turned on and the unit reverts to normal operation.
- o Freeze protection for **Freshbox E-200 ERV WiFi** and **Freshbox E2-200 ERV WiFi** is implemented with an electric preheater.

Heat and energy recovery

- o The unit is equipped with a counter-flow energy recovery core with an enthalpy membrane at the core.
 - **In the cold season** the exhaust air heat and moisture are transferred to the supply air stream through the enthalpy membrane reducing the heat losses through ventilation.
 - Consequently, it is the intake air heat and moisture transferred to the extract air stream **in the warm season**. This allows for a considerable reduction of the supply air temperature and humidity which, in turn, reduces the air conditioning load.



Operating principle

HEAT RECOVERY OPERATION MODE

- o **The cold outdoor air** passes through the filters and the heat exchanger and then is delivered to the serviced space by the supply centrifugal fan.
- o **Warm polluted air from the premise** flows through the filter and the heat exchanger and is exhausted outside with an extract centrifugal fan through an air duct in the wall.
- o **The supply and exhaust air** flows are fully separated which helps eliminate the possibility of odour or microbial transfer between the streams.

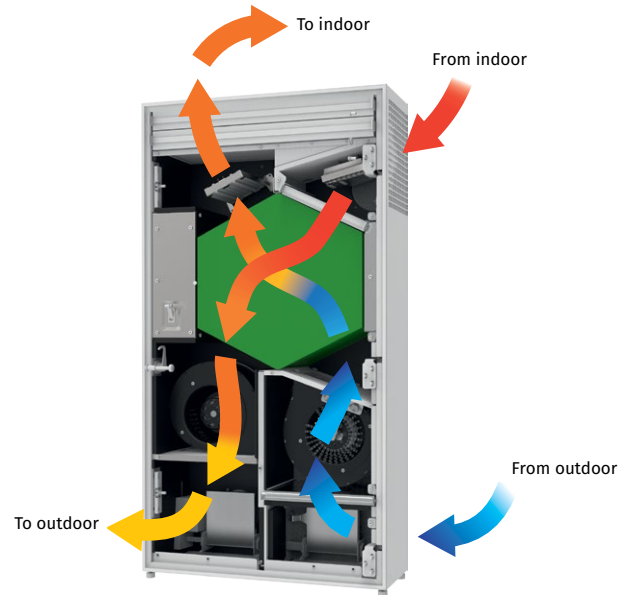

RECIRCULATION OPERATION MODE

- o The supply and exhaust air dampers are closed, the recirculation damper is open. The room air circulates through the filters. Then it is returned back to the room purified.

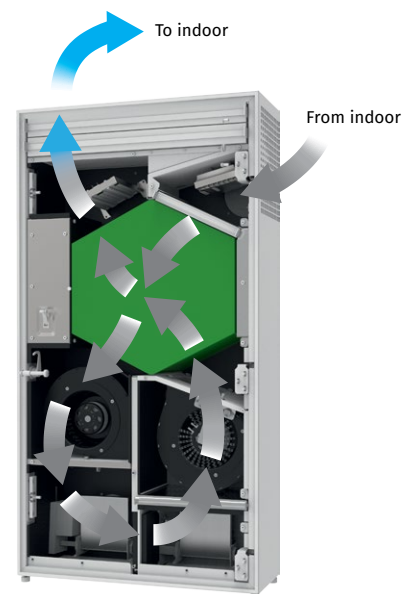

FRESHBOX 200 ERV WiFi

SINGLE-ROOM AIR HANDLING UNITS

Control

- The unit is equipped with a control panel.
- The remote control is supplied as standard
- Wi-Fi communication.



AUTOMATIC FUNCTIONS

	Freshbox 200 ERV WiFi Freshbox E-200 ERV WiFi	Freshbox E1-200 ERV WiFi Freshbox E2-200 ERV WiFi
Speed selection	•	•
Filter replacement indication	•	•
Alarm indication	•	•
Speed setup	•	•
Timer	•	•
Week scheduler	•	•
Reheater enabled/disabled		•
Supply air temperature setup		•
Control with the mobile application Android / iOS	•	•



Download
Android application
Blauberg Freshbox



Download
iOS application
Blauberg Freshbox

REMOTE CONTROL

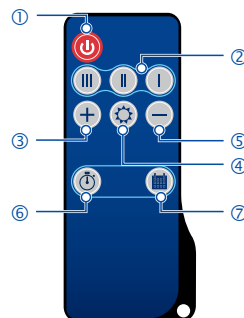

- 1 Turning unit on/off
- 2 Speed selection (Min/Mid/Max)
- 3 Increasing temperature set point for the reheater (available for the models with a reheater)
- 4 Turning reheater on/off (available for the models with a reheater)
- 5 Decreasing temperature set point for the reheater (available for the models with a reheater)
- 6 Turning timer on/off
- 7 Activation/deactivation of the scheduled operation mode

CONTROL PANEL

- ON/OFF button
- Speed changeover (down)
- Speed changeover (up)
- Weekly schedule
- Connection to WiFi
- Filter replacement indication
- Alarm indication

Technical data

Parameters	Freshbox 200 ERV WiFi					Freshbox E-200 ERV WiFi					Freshbox E1-200 ERV WiFi					Freshbox E2-200 ERV WiFi				
	I	II	III	IV	V	I	II	III	IV	V	I	II	III	IV	V	I	II	III	IV	V
Speed																				
Voltage [V / 50 (60) Hz]	1~230																			
Max. power without heater(s) [W]	10	15	25	44	134	10	15	25	44	134	10	15	25	44	134	10	15	25	44	134
Preheater power consumption [W]								650										650		
Reheater power consumption [W]													700					700		
Max. current consumption with heater(s) [A]				1.0				4.0					4.2					7.2		
Maximum air flow [m³/h (l/s)]	30 (8)	60 (17)	90 (25)	120 (33)	200 (56)	30 (8)	60 (17)	90 (25)	120 (33)	200 (56)	30 (8)	60 (17)	90 (25)	120 (33)	200 (56)	30 (8)	60 (17)	90 (25)	120 (33)	200 (56)
RPM [min ⁻¹]	2000																			
Sound pressure level at 3 m [dBA]	12	22	30	36	45	12	22	30	36	45	12	22	30	36	45	12	22	30	36	45
Transported air temperature [°C]	-15...+40																			
Casing material	polymer coated steel																			
Insulation thickness [mm]	30																			
Extract filter	G4																			
Supply filter	G4 + F7 (Option: H13)																			
Connected air duct diameter [mm]	100																			
Weight [kg]	55																			
Heat recovery efficiency [%]*	85	81	75	68	66	85	81	75	68	66	85	81	75	68	66	85	81	75	68	66
Heat recovery core type	counter-flow																			
Heat recovery core material	enthalpic membrane																			
SEC class	A																			

*Heat recovery efficiency is specified in compliance with EN 13141-8.

FRESHBOX 200 ERV WiFi

SINGLE-ROOM AIR HANDLING UNITS

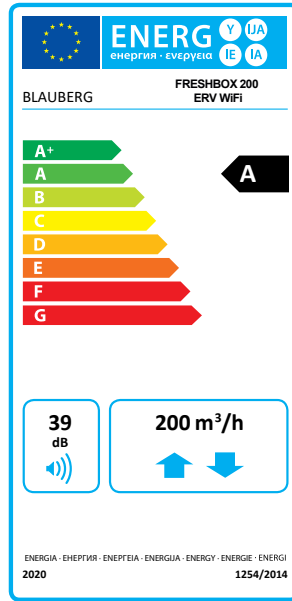
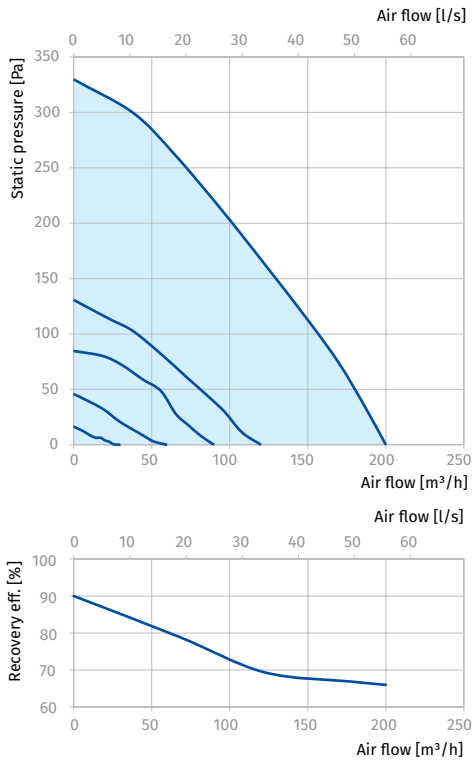

Overall dimensions [mm]

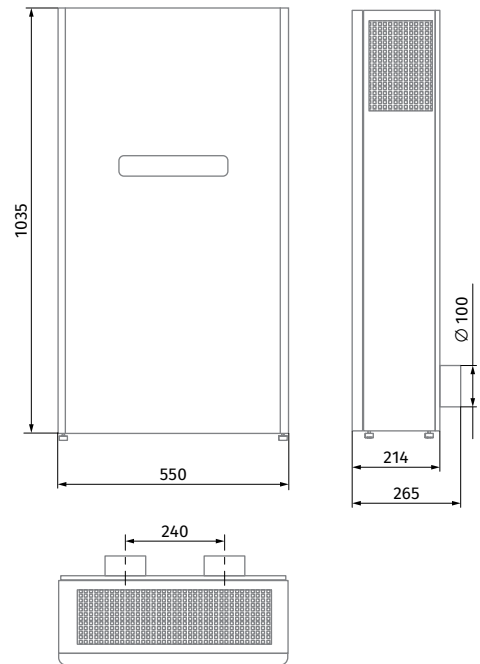

FRESHBOX 200 ERV WiFi

SINGLE-ROOM AIR HANDLING UNITS

Mounting example

Each space requiring ventilation is equipped with one or several **Freshbox 200 ERV WiFi** units.

Can be upgraded with a bathroom exhaust air duct. To enable such a configuration the units can be additionally equipped with the optional \varnothing 100 mm spigot (supplied as standard).

FRESHBOX 200 ERV WiFi MOUNTING EXAMPLE IN THE OFFICE

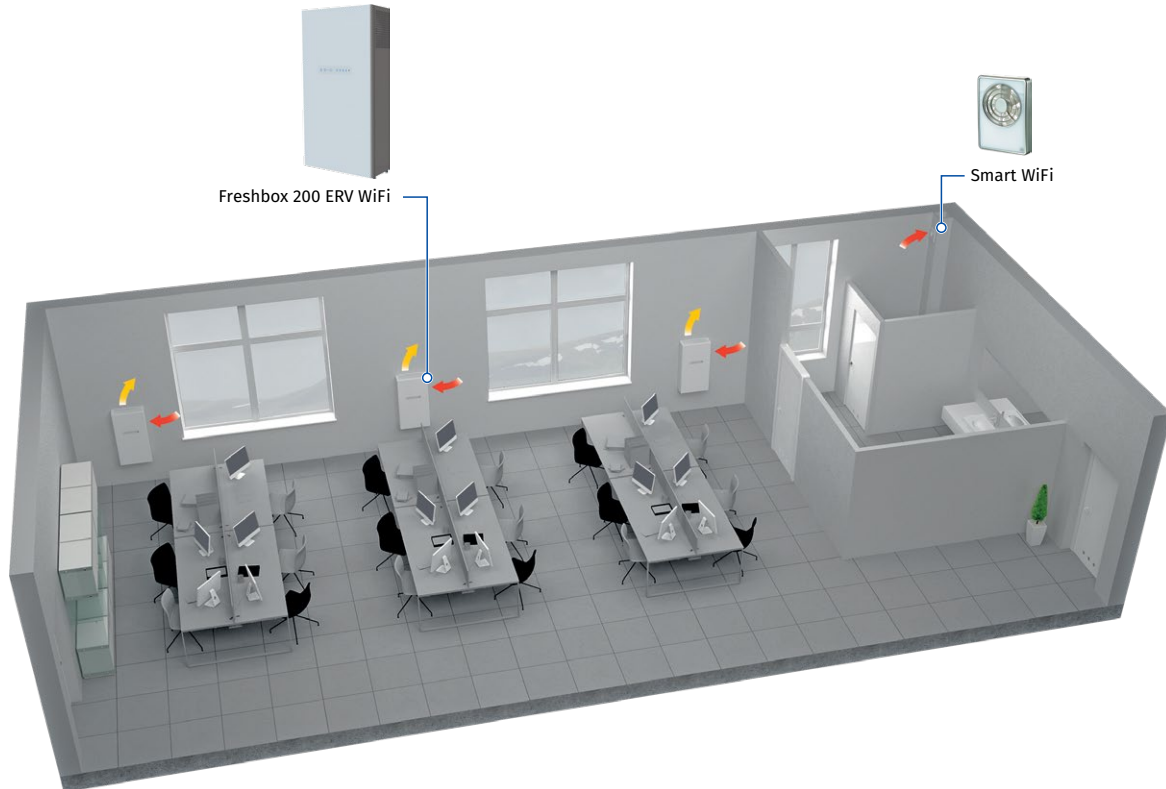



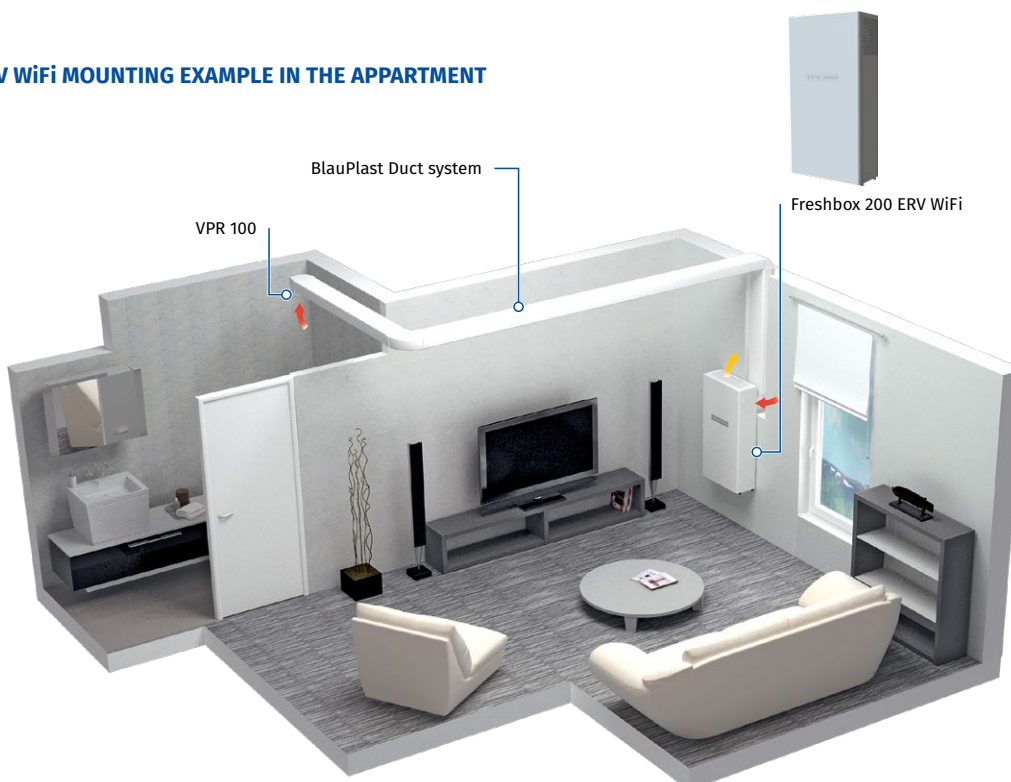







FRESHBOX 200 ERV WiFi MOUNTING EXAMPLE IN THE APARTMENT



FRESHBOX 200 ERV WiFi

SINGLE-ROOM AIR HANDLING UNITS

Accessories

Name		Description
MS Freshbox 200 chrome		Mounting kit: • Two Ø 100 mm air ducts, 500 mm long • Ventilation outer hood made of polished steel • Cardboard template
MS Freshbox 200 white		Mounting kit: • Two Ø 100 mm air ducts, 500 mm long • Ventilation outer hood, painted white • Cardboard template
AH Freshbox 200 chrome		Ventilation outer hood made of polished steel
AH Freshbox 200 white		Ventilation outer hood, painted white
FP 201x162x20 G4		Exhaust G4 panel filter
FP 243x162x20 G4		Supply G4 panel filter
FP 502x162x40 F7		Supply F7 panel filter
FP 502x162x40 H13		Supply HEPA H13 panel filter
HR-S		Humidity sensor
CD-1		CO ₂ sensor with LED CO ₂ indication and a sensor button for operation mode selection
CD-2		CO ₂ sensor

CIVIC EC LB

SINGLE-ROOM AIR HANDLING UNITS

Features

- The **CIVIC EC LB** units are designed for singleroom ventilation of schools, offices and other public and commercial premises. Offer the ideal simple and efficient ventilation solutions for existing and renovated buildings and require no layout of air ducts.
- Efficient supply and extract ventilation for separate premises.
- EC motors with low energy consumption.
- Low-noise operation.
- Simple mounting.



Air flow:
up to 1240 m³/h
344 l/s



Heat recovery efficiency:
up to 96 %



Design

- Made of high-quality polymer coated steel, internally lined with heat- and sound insulation of mineral wool, cellular synthetic rubber or other materials.
- Built-in preheater and reheater modifications available for cold climate conditions.

Motors

- High efficient electronically commutated motors with external motor and impeller with forward curved blades. Such motors are the most state-of-the-art energy saving solution.
- EC motors are featured with high performance and total speed controllable range. High efficiency reaching 90 % is the premium advantage of the electronically commutated motors.

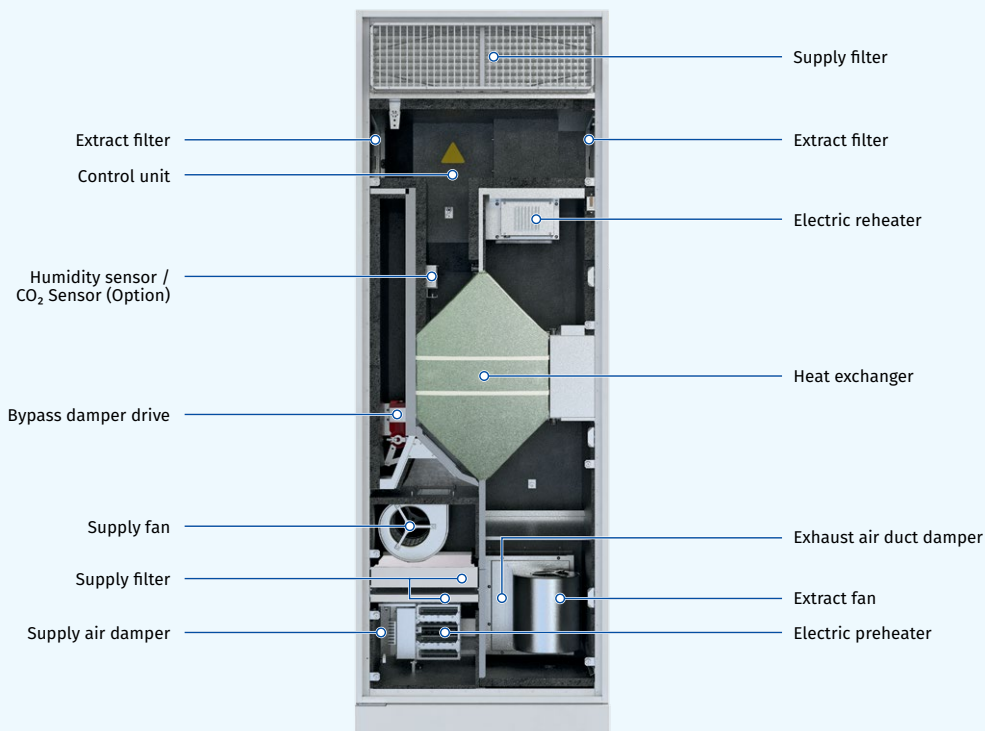

Designation key

Model	Motor type	Mounting	Bypass	Heater	Drain pump	Rated air flow [m ³ /h]	Heat exchanger type	Service side (for Civic...1200)	Control
CIVIC	EC: synchronous electronically commutated motor	L: floor mounting	B: with bypass	_: without heater E: preheating E2: preheating + reheating	_: without drain pump CP: with drain pump	300; 500; 1200	_: heat recovery -E: energy recovery	L: Left R: Right	S21 S14

CIVIC EC LB

SINGLE-ROOM AIR HANDLING UNITS

Air filtration

- Supply and extract air is purified by a set of panel filters. Filtering class depends on the unit model.
- Panel G4 filter is used for extract air filtration.

Bypass

- The units are equipped with a bypass. The bypass damper opens for free cooling ventilation mode in summer.

Air dampers

- The automatic supply and extract air dampers are used to prevent uncontrollable air draughts during the unit standstill.

Heaters

PREHEATING

- CIVIC EC LBE** and **CIVIC EC LBE2** units are equipped with an electric preheater which protects the heat exchanger from freezing.

REHEATING

- CIVIC EC LBE2** units feature an electric reheater to raise the supply air temperature.

Heat exchanger

- The **CIVIC EC LB** unit has a counter-flow heat exchanger made of polystyrene.
 - In cold season** the heat energy of the extract air flow is absorbed by intake air flow, thus decreasing the heat losses caused by ventilation. Condensate generated during heat recovery is collected in a drain pan and removed to the sewage system.
 - In warm season** the heat of the outdoor air is absorbed by extract air flow. This way the supply air temperature decreases and heat recovery reduces operation loads for the air conditioner.
- The **CIVIC EC LB... -E** unit is equipped with a counter-flow heat exchanger made of enthalpy membrane.
 - In cold season** the heat and moisture of the extract air are absorbed by supply air through the enthalpy membrane, thus decreasing the heat losses caused by ventilation.
 - In warm season** the heat and humidity of the outdoor air is absorbed by extract air flow through the enthalpy membrane. This way the supply air temperature and humidity decreases and heat recovery reduces operation loads for the air conditioner.



Functioning

- Cold outside air** flows through the filters and heat exchanger and is moved to the room with a supply centrifugal fan.
- Warm polluted air from the premise** flows through the filter and the heat exchanger and is exhausted outside with an extract centrifugal fan through an air duct in the wall.



Control and automation

- The **CIVIC EC LB... S21** units are equipped with an integrated automation system.
- The S21 controller allows integrating the unit into the **BMS (Building Management System)**.
- The unit can be controlled by the **Blauberg AHU** mobile application via Wi-Fi.



Download the **Blauberg AHU** app for Android





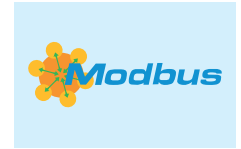

Download the **Blauberg AHU** app for iOS



- The **CIVIC EC LB... S14** units are equipped with an integrated automation system and the S14 wall mounted sensor control panel with LED-indication.

Automation functions

Functions	CIVIC EC LB... S21	CIVIC EC LB... S14
Unit control via Wi-Fi using the mobile application	+	-
Unit control via remote control panel	S22 control panel (option) 	S14 control panel 
Unit control via remote wireless control panel	S22 Wi-Fi control panel (option) 	-
Unit control via a wired remote LCD control panel	S25 control panel (option) 	-
BMS (Building Management System)	RS-485	-
	Wi-Fi	-
	Ethernet	-
	MODBUS (RTU, TCP)	-
Blauberg Cloud Server service	+	-
Speed switch	+	+
Filter replacement indication	by filter timer (in the Blauberg AHU App or on the optional control panel S25)	by filter timer (on the S14 control panel)
Alarm indication	full alarm description in the mobile application	LED indication about alarms
Week scheduled operation	+	-
Bypass	automatic	manual
Timer	+	-
Boost mode	+	-
Fireplace mode	+	-
Freeze protection	using cyclical stops of the supply fan	using cyclical stops of the supply fan
	using preheating (option)	-
Reheater connection	option	-
Cooler connection	option	-
Minimum supply air temperature control	+	-
Humidity control	option	option
CO ₂ control	option	option
VOC control	option	-
PM2.5 control	option	-
Fire alarm sensor connection	option	option

Option: the functionality is available when purchasing the appropriate accessory (see the "Accessories" section)

CIVIC EC LB

SINGLE-ROOM AIR HANDLING UNITS

Technical data

Parameters	Civic EC LB 300 S21 Civic EC LB 300 S14	Civic EC LBE 300 S21	Civic EC LBE2 300 S21	Civic EC LB 300-E S21 Civic EC LB 300-E S14	Civic EC LBE 300-E S21	Civic EC LBE2 300-E S21
Voltage [V / 50 (60) Hz]	1~230	1~230	1~230	1~230	1~230	1~230
Power consumption without heater(s) [W]	125	125	125	125	125	125
Preheater power consumption [W]	-	1400	1400	-	1400	1400
Reheater power consumption [W]	-	-	1400	-	-	1400
Max. current consumption without heater(s) [A]	0.9	0.9	0.9	0.9	0.9	0.9
Max. current consumption with heater(s) [A]	0.9	7	13.1	0.9	7	13.1
Maximum air flow [m ³ /h (l/s)]	320 (89)	320 (89)	320 (89)	320 (89)	320 (89)	320 (89)
RPM [min ⁻¹]	2150	2150	2150	2150	2150	2150
Sound pressure level at 1 m [dBA]	31	31	31	31	31	31
Sound pressure level at 3 m [dBA]	21	21	21	21	21	21
Transported air temperature [°C]	-25...+40	-25...+40	-25...+40	-25...+40	-25...+40	-25...+40
Casing material	polymer coated steel	polymer coated steel	polymer coated steel	polymer coated steel	polymer coated steel	polymer coated steel
Insulation	40 mm, mineral wool	40 mm, mineral wool	40 mm, mineral wool	40 mm, mineral wool	40 mm, mineral wool	40 mm, mineral wool
Extract filter	G4 x 2	G4 x 2	G4 x 2	G4 x 2	G4 x 2	G4 x 2
Supply filter	G4 + F8 (option: F8 C + H11)	G4 + F8 (option: F8 C + H11)	G4 + F8 (option: F8 C + H11)	G4 + F8 (option: F8 C + H11)	G4 + F8 (option: F8 C + H11)	G4 + F8 (option: F8 C + H11)
Connected air duct diameter [mm]	200	200	200	200	200	200
Weight [kg]	138 ± 3 %	139 ± 3 %	140 ± 3 %	136 ± 3 %	137 ± 3 %	138 ± 3 %
Heat exchanger type	counter-flow	counter-flow	counter-flow	counter-flow	counter-flow	counter-flow
Heat exchanger material	polystyrene	polystyrene	polystyrene	enthalpic membrane	enthalpic membrane	enthalpic membrane
Heat recovery efficiency* [%]	78...92	78...92	78...92	73...89	73...89	73...89
SEC class	A	A	A	A	A	A

*Heat recovery efficiency is specified in compliance with EN 13141-8.

Parameters	Civic EC LB 500 S21 Civic EC LB 500 S14	Civic EC LBE 500 S21	Civic EC LBE2 500 S21	Civic EC LB 1200 S21	Civic EC LBE 1200 S21	Civic EC LBE2 1200 S21
Voltage [V / 50 (60) Hz]	1~230	1~230	1~230	3~400	3~400	3~400
Power consumption without heater(s) [W]	230	230	230	350	350	350
Preheater power consumption [W]	-	1400	1400	-	6300	6300
Reheater power consumption [W]	-	-	2800	-	-	6300
Max. current consumption without heater(s) [A]	1.7	1.7	1.7	1.6	1.6	1.6
Max. current consumption with heater(s) [A]	1.7	7.8	20	1.6	9.6	18.7
Maximum air flow [m ³ /h (l/s)]	580 (161)	580 (161)	580 (161)	1240 (344)	1240 (344)	1240 (344)
RPM [min ⁻¹]	1280	1280	1280	3630	3630	3630
Sound pressure level at 1 m [dBA]	35	35	35	34	34	34
Sound pressure level at 3 m [dBA]	25	25	25	24	24	24
Transported air temperature [°C]	-25...+40	-25...+40	-25...+40	-25...+40	-25...+40	-25...+40
Casing material	polymer coated steel	polymer coated steel	polymer coated steel	polymer coated steel	polymer coated steel	polymer coated steel
Insulation	40 mm, mineral wool	40 mm, mineral wool	40 mm, mineral wool	40 mm, mineral wool	40 mm, mineral wool	40 mm, mineral wool
Extract filter	G4 x 2	G4 x 2	G4 x 2	G4	G4	G4
Supply filter	G4 + F8 (option: F8 C + H11)	G4 + F8 (option: F8 C + H11)	G4 + F8 (option: F8 C + H11)	G4 + (option: F7)	G4 + (option: F7)	G4 + (option: F7)
Connected air duct diameter [mm]	250	250	250	400	400	400
Weight [kg]	191 ± 3 %	193 ± 3 %	194 ± 3 %	394	398	402
Heat exchanger type	counter-flow	counter-flow	counter-flow	counter-flow	counter-flow	counter-flow
Heat exchanger material	polystyrene	polystyrene	polystyrene	polystyrene	polystyrene	polystyrene
Heat recovery efficiency* [%]	75...94	75...94	75...94	84...96	84...96	84...96
SEC class	A	A	A	A+	A+	A+

*Heat recovery efficiency is specified in compliance with EN 13141-8.

CIVIC EC LB

SINGLE-ROOM AIR HANDLING UNITS

CIVIC EC LB/LBE/LBE2 300

Sound-power level, A - weighted	Total	Octave frequency band [Hz]								LpA 3 m	LpA 1 m
		63	125	250	500	1000	2000	4000	8000		
LwA to environment @ point 1 [dBA]	42	25	28	30	37	36	36	29	21	21	31
LwA to environment @ point 5 [dBA]	36	22	26	32	25	29	27	21	14	15	25
LwA to environment @ point 9 [dBA]	31	13	18	22	23	18	27	25	16	11	21

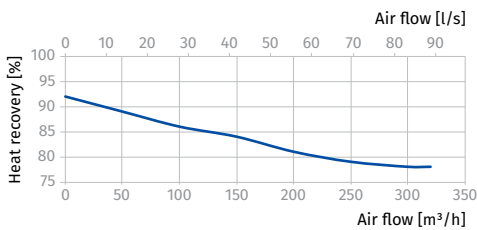
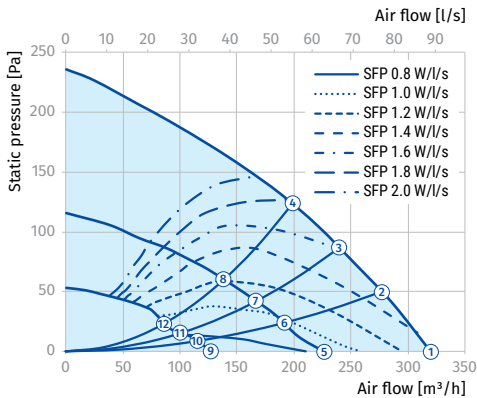

Point	Total power of the unit [W]	Total sound pressure level at 3 m (1 m) [dBA]
1	125	21 (31)
2	113	20 (30)
3	108	20 (30)
4	100	19 (29)
5	55	15 (25)
6	52	15 (25)
7	50	15 (25)
8	45	14 (24)
9	24	11 (21)
10	23	11 (21)
11	23	11 (21)
12	23	10 (20)

CIVIC EC LB/LBE/LBE2 500

Sound-power level, A - weighted	Total	Octave frequency band [Hz]								LpA 3 m	LpA 1 m
		63	125	250	500	1000	2000	4000	8000		
LwA to environment @ point 1 [dBA]	46	21	32	38	41	41	35	25	15	25	35
LwA to environment @ point 5 [dBA]	39	14	20	29	29	36	28	29	13	18	28
LwA to environment @ point 9 [dBA]	33	8	18	21	20	32	19	21	12	13	23

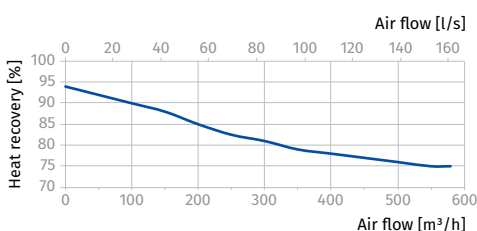
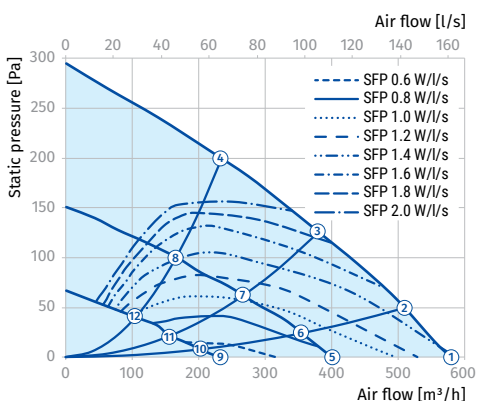

Point	Total power of the unit [W]	Total sound pressure level at 3 m (1 m) [dBA]
1	230	25 (35)
2	215	25 (35)
3	170	24 (34)
4	168	24 (34)
5	98	18 (28)
6	92	18 (28)
7	85	18 (28)
8	75	17 (28)
9	33	13 (23)
10	31	13 (23)
11	30	12 (22)
12	29	12 (22)

CIVIC EC LB

SINGLE-ROOM AIR HANDLING UNITS

CIVIC EC LB/LBE/LBE2 1200

Sound-power level, A - weighted	Total	Octave frequency band [Hz]								LpA 3 m	LpA 1 m
		63	125	250	500	1000	2000	4000	8000		
LWA to environment @ point 1 [dBA]	44	31	35	40	37	36	36	28	17	24	34
LWA to environment @ point 5 [dBA]	38	27	31	33	29	30	27	22	13	17	27
LWA to environment @ point 9 [dBA]	32	21	27	21	25	17	19	24	16	11	21

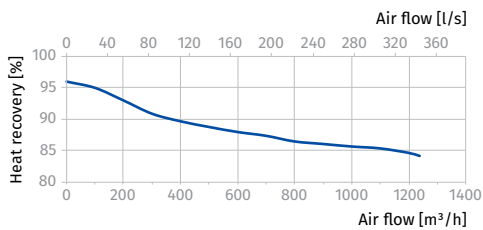
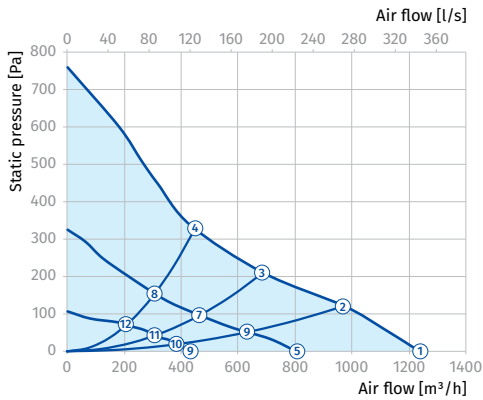

Point	Total power of the unit [W]	Total sound pressure level at 3 m (1 m) [dBA]
1	350	24 (34)
2	356	24 (34)
3	358	23 (33)
4	356	23 (33)
5	127	15 (25)
6	129	15 (25)
7	129	14 (24)
8	129	14 (24)
9	50	11 (21)
10	50	11 (21)
11	50	11 (21)
12	48	10 (20)

Fresh air flow distance for CIVIC EC LB 300

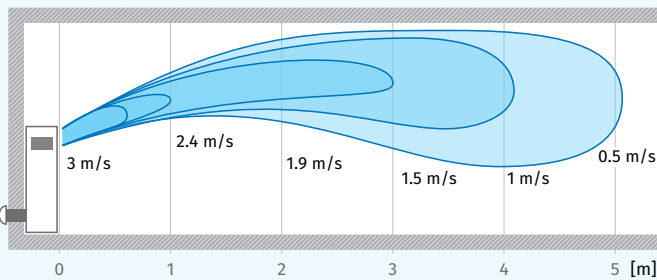

Fresh air flow distance for CIVIC EC LB 500

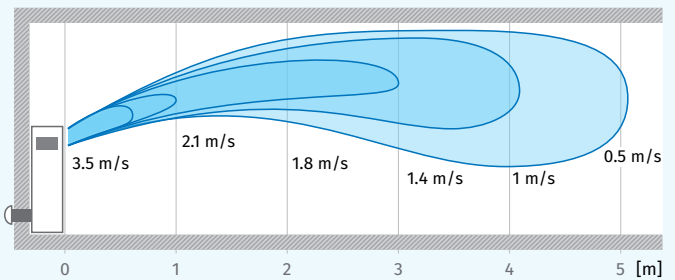

Fresh air flow distance for CIVIC EC LB 1200

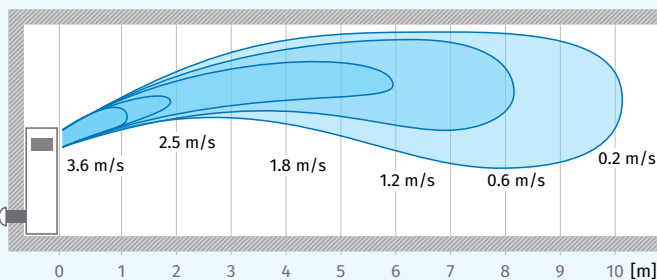

The unit is rated for indoor application with the ambient temperature ranging from +1 °C to +40 °C and relative humidity up to 80%.

CIVIC EC LB

SINGLE-ROOM AIR HANDLING UNITS

Overall dimensions [mm]

Model	∅ D	H	H1	H2	H3	H4	L	L1	W	W1	W2
CIVIC EC LB 300	200	1770	1476	294	-	-	470	520	620	230	195
CIVIC EC LB 500	250	2170	1833	337	-	-	535	585	750	290	230
CIVIC EC LB 1200	397	2000	2106	545	1110	70	535	265	1900	1951	-

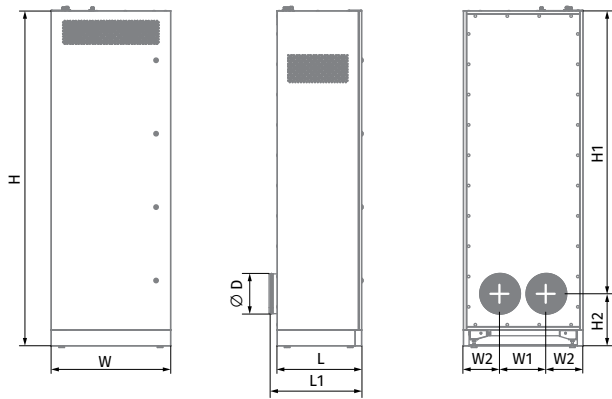

CIVIC EC LB 300 / CIVIC EC LB 500

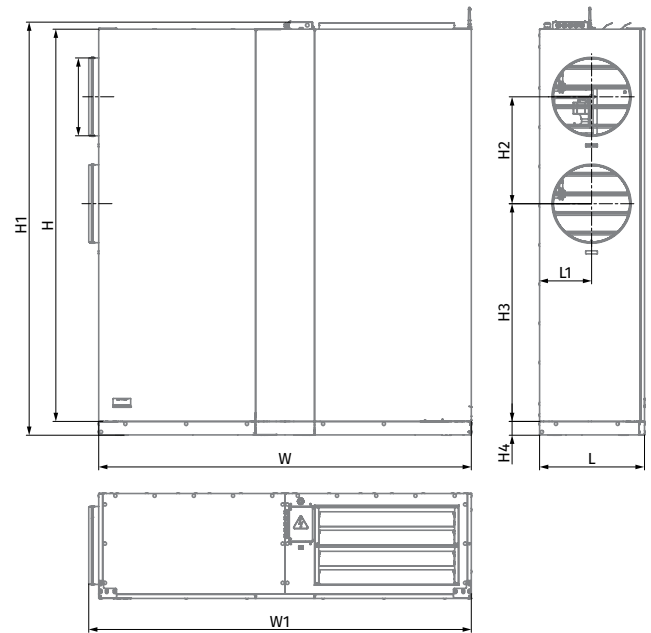















CIVIC EC LB 1200

CIVIC EC LB





SINGLE-ROOM AIR HANDLING UNITS

Accessories

		Civic EC LB... 300 S21	Civic EC LB... 500 S21	Civic EC LB... 500 S14	Civic EC LB... 1200 S21
Outer ventilation hood made of brushed stainless steel		AH Civic 300 LB chrome	AH Civic 500 LB chrome	AH Civic 500 LB chrome	AH Civic 1200 LB chrome
Outer ventilation hood made of white coated stainless steel		AH Civic 300 LB white	AH Civic 500 LB white	AH Civic 500 LB white	AH Civic 1200 LB white
G4 filter		FP 308x238x22 G4 PPI	FP 450x257x27 G4 PPI	FP 450x257x27 G4 PPI	FP 450x395x48 G4 PET
G4 filter		FP 265x213x48 G4	FP 318x290x22 G4	FP 318x290x22 G4	FP 540x450x48 G4
F7 filter		-	-	-	FP 540x450x48 F7
F8 filter		FP 384x273x60 F8	FP 318x290x60 F8	FP 318x290x60 F8	-
F8 carbon filter		FP 533x135x48 F8 C	FP 666x196x48 F8 C	FP 666x196x48 F8 C	-
H11 HEPA filter		FP 533x135x60 H11	FP 666x196x60 H11	FP 666x196x60 H11	-
Control panel		S22	S22	S14	S22
Wi-Fi control panel		S22 Wi-Fi	S22 Wi-Fi	-	S22 Wi-Fi
LCD Control panel		S25	S25	-	S25
VOC sensor		DPWQ30600	DPWQ30600	-	DPWQ30600
CO ₂ sensor		DPWQ40200	DPWQ40200	-	DPWQ40200
Humidity sensor		DPWC11200	DPWC11200	-	DPWC11200

CIVIC EC LB

SINGLE-ROOM AIR HANDLING UNITS

		Civic EC LB... 300 S21	Civic EC LB... 500 S21	Civic EC LB... 500 S14	Civic EC LB... 1200 S21
CO ₂ sensor with indication		CD-1	CD-1	CD-1	CD-1
CO ₂ sensor		CD-2	CD-2	CD-2	CD-2
Internal humidity sensor		FS2	FS2	FS2	FS2
Humidity sensor		HR-S	HR-S	HR-S	HR-S
Syphon kit		SFK 20x32	SFK 20x32	SFK 20x32	SFK 20x32
Drain pump		CP-2	CP-2	CP-2	CP-2

CIVIC EC DB

SINGLE-ROOM AIR HANDLING UNITS

Features

- The **CIVIC EC DB** units are designed for single-room ventilation of schools, offices and other public and commercial premises. Offer the ideal simple and efficient ventilation solutions for existing and renovated buildings and require no layout of air ducts.
- Efficient supply and extract ventilation for separate premises.
- EC motors with low energy consumption.
- Low-noise operation.
- Simple mounting.



Air flow:
up to 1000 m³/h
278 l/s



Heat recovery efficiency:
up to 93 %



Design

- Made of high-quality polymer coated steel, internally lined with heat- and sound insulation of mineral wool, cellular synthetic rubber or other materials.
- Available modifications with an integrated preheater and reheater for cold climate applications.

Motors

- High efficient electronically commutated motors with external motor and impeller with forward curved blades. Such motors are the most state-of-the-art energy saving solution.
- EC motors are featured with high performance and total speed controllable range. High efficiency reaching 90% is the premium advantage of the electronically commutated motors.

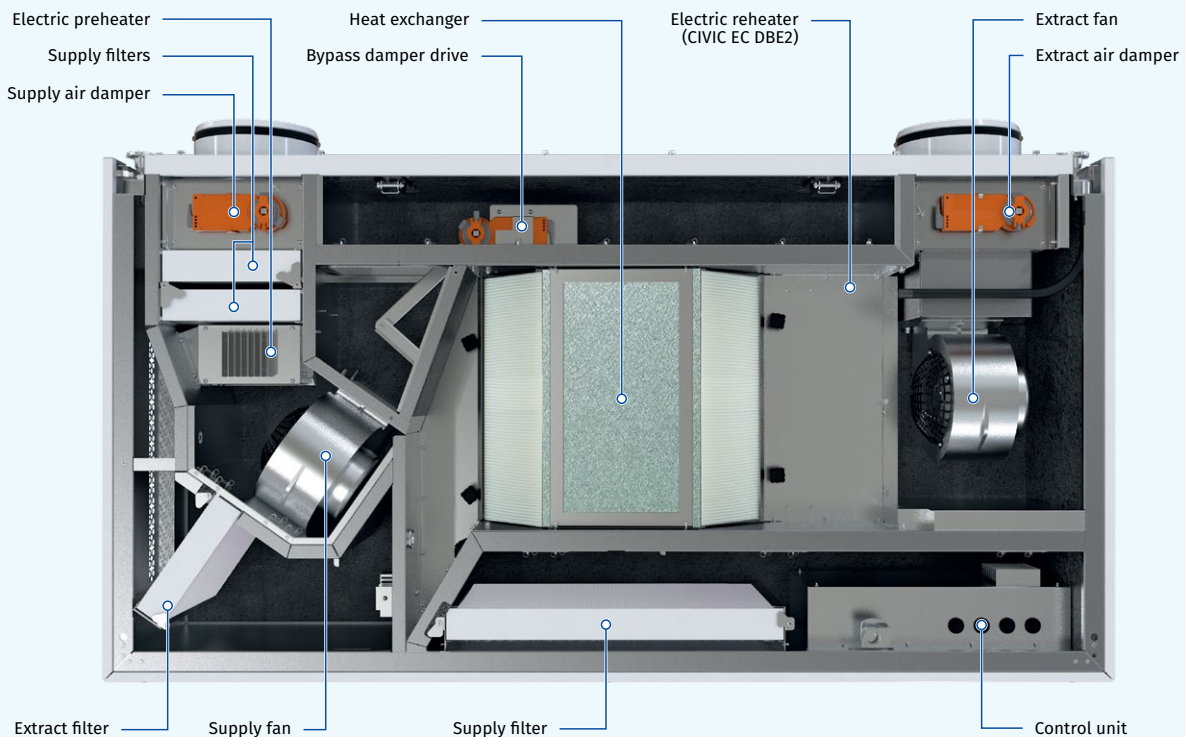

Designation key

Model	Motor type	Mounting	Bypass	Heater	Drain pump*	Rated air flow [m ³ /h]	Control
CIVIC	EC: synchronous electronically commutated motor	D: Suspended mounting, horizontally oriented spigots; D1: Suspended mounting, vertically oriented spigots	B: with bypass	_: without heater E: preheating E2: preheating + reheating	_: without drain pump CP: with drain pump	300; 500; 1000	S21

* The CIVIC EC DB... 1000 S21 units are equipped with a drain pump by default.

CIVIC EC DB

SINGLE-ROOM AIR HANDLING UNITS

Air filtration

- Supply and extract air is purified by a set of panel filters. Filtering class depends on the unit model.
- Panel G4 filter is used for extract air filtration.

Bypass

- The units are equipped with a bypass. The bypass damper opens for free cooling ventilation mode in summer.

Air dampers

- The automatic supply and extract air dampers are used to prevent uncontrollable air draughts during the unit standstill.

Heater

PREHEATING

- CIVIC EC DBE and CIVIC EC DBE2 units are equipped with an electric preheater which protects the heat exchanger from freezing.

REHEATING

- CIVIC EC DBE2 units feature an electric reheater to raise the supply air temperature.

Heat exchanger

- The CIVIC EC DB unit has a counter-flow heat exchanger made of polystyrene.
 - In cold season** the heat energy of the extract air flow is absorbed by intake air flow, thus decreasing the heat losses caused by ventilation. Condensate generated during heat recovery is collected in a drain pan and removed through the drain pipes to the sewage system.
 - In warm season** the heat of the outdoor air is absorbed by extract air flow. This way the supply air temperature decreases and heat recovery reduces operation loads for the air conditioner.



Functioning

- Cold outside air** flows through the filters and heat exchanger and is moved to the room with a supply centrifugal fan.
- Warm polluted air from the premise** flows through the filter and the heat exchanger and is exhausted outside with an extract centrifugal fan through an air duct in the wall.



Control and automation

- The CIVIC EC DB S21 units are equipped with an integrated automation system.
- The S21 controller allows integrating the unit into the **BMS (Building Management System)**.
- The unit can be controlled by the **Blauberg AHU** mobile application via Wi-Fi.





Download the **Blauberg AHU** app for Android

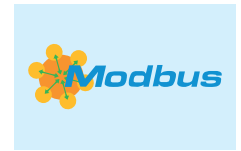

Download the **Blauberg AHU** app for iOS



Automation functions

Functions	Description
Unit control via Wi-Fi using the mobile application	+
Unit control via remote control panel	S22 control panel (option) 
Unit control via remote wireless control panel	S22 Wi-Fi control panel (option) 
Unit control via a wired remote LCD control panel	S25 control panel (option) 
BMS (Building Management System)	RS-485 Wi-Fi Ethernet MODBUS (RTU, TCP)
Blauberg Cloud Server service	+
Speed switch	+
Filter replacement indication	by filter timer
Alarm indication	full alarm description in the mobile application
Week scheduled operation	+
Bypass	automatic manual
Timer	+
Boost mode	+
Fireplace mode	+
Freeze protection	using cyclical stops of the supply fan using preheating (option)
Reheater connection	option
Cooler connection	option
Minimum supply air temperature control	+
Humidity control	option
CO ₂ control	option
VOC control	option
PM2.5 control	option
Fire alarm sensor connection	option

Option: the functionality is available when purchasing the appropriate accessory (see the "Accessories" section)

CIVIC EC DB

SINGLE-ROOM AIR HANDLING UNITS

Technical data

Parameters	CIVIC EC DB 300 S21	CIVIC EC DBE 300 S21	CIVIC EC DBE2 300 S21	CIVIC EC DB 500 S21	CIVIC EC DBE 500 S21	CIVIC EC DBE2 500 S21
Voltage [V / 50 (60) Hz]	1~ 230	1~ 230	1~ 230	1~ 230	1~ 230	1~ 230
Power consumption without heater(s) [W]	125	125	125	170	170	170
Preheater power consumption [W]	-	1050	1050	-	1750	1750
Reheater power consumption [W]	-	-	1400	-	-	1750
Max. current consumption without heater(s) [A]	1.3	1.3	1.3	1.7	1.7	1.7
Max. current consumption with heater(s) [A]	1.3	7.3	13.6	1.7	10.4	18.2
Maximum air flow [m³/h (l/s)]	300 (83)	300 (83)	300 (83)	510 (142)	510 (142)	510 (142)
RPM [min ⁻¹]	2150	2150	2150	1700	1700	1700
Sound pressure level at 1 m [dBA]	33	33	33	34	34	34
Sound pressure level at 3 m [dBA]	23	23	23	24	24	24
Max. transported air temperature [°C]	-25 ... +40	-25 ... +40	-25 ... +40	-25 ... +40	-25 ... +40	-25 ... +40
Casing material	polymer coated steel	polymer coated steel	polymer coated steel	polymer coated steel	polymer coated steel	polymer coated steel
Insulation	25 mm, cellular synthetic rubber	25 mm, cellular synthetic rubber	25 mm, cellular synthetic rubber	25 mm, cellular synthetic rubber	25 mm, cellular synthetic rubber	25 mm, cellular synthetic rubber
Extract filter	G4	G4	G4	G4	G4	G4
Supply filter	G4, F8 (option F8 C + H11)	G4, F8 (option F8 C + H11)	G4, F8 (option F8 C + H11)	G4, F8 (option F8 C + H11)	G4, F8 (option F8 C + H11)	G4, F8 (option F8 C + H11)
Connected air duct diameter [mm]	200	200	200	250	250	250
Weight [kg]	78	79	80	126	128	130
Heat exchanger type	counter-flow	counter-flow	counter-flow	counter-flow	counter-flow	counter-flow
Heat exchanger material	polystyrene	polystyrene	polystyrene	polystyrene	polystyrene	polystyrene
Heat recovery efficiency* [%]	76 ... 88%	76 ... 88%	76 ... 88%	74 ... 86%	74 ... 86%	74 ... 86%
SEC class	A	A	A	A	A	A

*Heat recovery efficiency is specified in compliance with EN 13141-8.

Parameters	CIVIC EC DB 1000 S21	CIVIC EC DBE 1000 S21	CIVIC EC DBE2 1000 S21
Voltage [V / 50 (60) Hz]	1~ 230	3~400	3~400
Power consumption without heater(s) [W]	260	260	260
Preheater power consumption [W]	-	6300	6300
Reheater power consumption [W]	-	-	6300
Max. current consumption without heater(s) [A]	1.85	1.85	1.85
Max. current consumption with heater(s) [A]	1.85	11.2	20.5
Maximum air flow [m³/h (l/s)]	1000 (278)	1000 (278)	1000 (278)
RPM [min ⁻¹]	2070	2070	2070
Sound pressure level at 1 m [dBA]	34	34	34
Sound pressure level at 3 m [dBA]	24	24	24
Max. transported air temperature [°C]	-25...+40	-25...+40	-25...+40
Casing material	polymer coated steel	polymer coated steel	polymer coated steel
Insulation	25 mm, cellular synthetic rubber	25 mm, cellular synthetic rubber	25 mm, cellular synthetic rubber
Extract filter	G4 x 2	G4 x 2	G4 x 2
Supply filter	G4x2 + (option: F7 x 2)	G4x2 + (option: F7 x 2)	G4x2 + (option: F7 x 2)
Connected air duct diameter [mm]	315	315	315
Weight [kg]	267	271	275
Heat exchanger type	counter-flow	counter-flow	counter-flow
Heat exchanger material	polystyrene	polystyrene	polystyrene
Heat recovery efficiency* [%]	83...93	83...93	83...93
SEC class	A+	A+	A+

*Heat recovery efficiency is specified in compliance with EN 13141-8.

CIVIC EC DB

SINGLE-ROOM AIR HANDLING UNITS

CIVIC EC DB/DBE/DBE2 300

Sound-power level, A - weighted	Total	Octave frequency band [Hz]								LpA 3 m	LpA 1 m
		63	125	250	500	1000	2000	4000	8000		
LwA to environment @ point 1 [dBA]	44	28	32	34	38	39	37	28	24	23	33
LwA to environment @ point 5 [dBA]	40	25	25	37	28	33	29	23	17	19	29
LwA to environment @ point 9 [dBA]	32	16	21	25	25	20	27	22	20	12	22

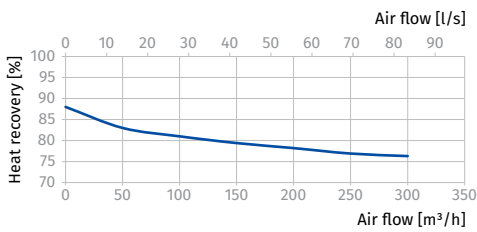
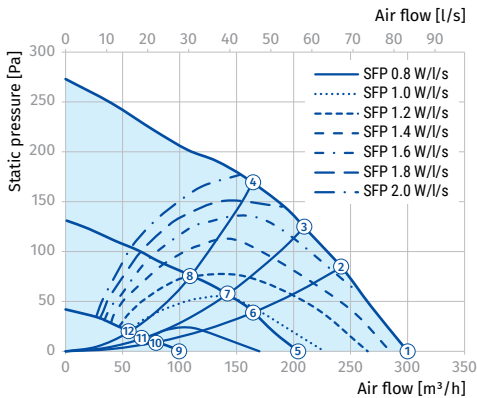

Point	Total power of the unit [W]	Total sound pressure level at 3 m (1 m) [dBA]
1	125	23 (33)
2	116	22 (22)
3	104	22 (32)
4	86	21 (31)
5	48	19 (29)
6	44	19 (29)
7	42	19 (29)
8	36	19 (28)
9	17	12 (22)
10	17	12 (22)
11	16	12 (22)
12	16	12 (22)

CIVIC EC DB/DBE/DBE2 500

Sound-power level, A - weighted	Total	Octave frequency band [Hz]								LpA 3 m	LpA 1 m
		63	125	250	500	1000	2000	4000	8000		
LwA to environment @ point 1 [dBA]	44	22	28	38	41	37	33	25	14	24	34
LwA to environment @ point 5 [dBA]	40	18	24	32	32	36	28	29	15	19	29
LwA to environment @ point 9 [dBA]	34	10	17	22	21	33	18	18	15	13	23

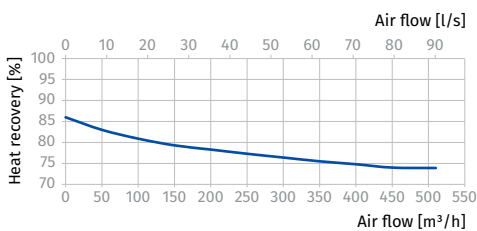
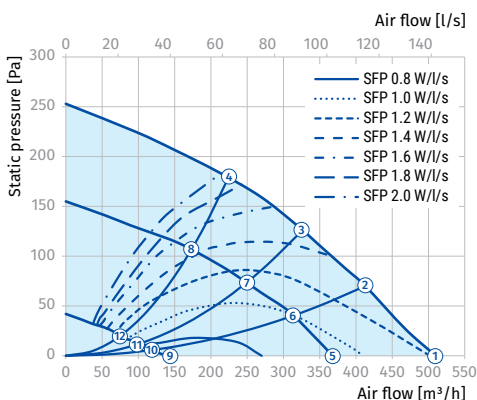

Point	Total power of the unit [W]	Total sound pressure level at 3 m (1 m) [dBA]
1	170	24 (34)
2	153	23 (33)
3	135	23 (33)
4	116	22 (32)
5	95	19 (29)
6	86	19 (29)
7	80	19 (29)
8	68	18 (28)
9	25	13 (23)
10	24	13 (23)
11	24	13 (23)
12	22	13 (23)

CIVIC EC DB

SINGLE-ROOM AIR HANDLING UNITS

CIVIC EC DB/DBE/DBE2 1000

Sound-power level, A - weighted	Total	Octave frequency band [Hz]								LpA 3 m	LpA 1 m
		63	125	250	500	1000	2000	4000	8000		
LWA to environment @ point 1 [dBA]	45	31	37	40	37	36	36	29	18	24	34
LWA to environment @ point 5 [dBA]	37	26	29	32	29	29	29	24	15	17	27
LWA to environment @ point 9 [dBA]	32	21	26	20	25	19	20	25	18	11	21

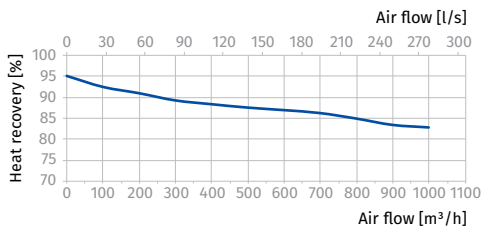
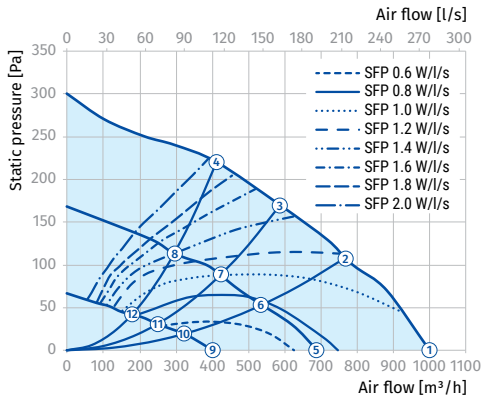

Point	Total power of the unit [W]	Total sound pressure level at 3 m (1 m) [dBA]
1	260	24 (34)
2	251	23 (33)
3	235	23 (33)
4	221	22 (32)
5	136	17 (27)
6	130	17 (27)
7	125	16 (27)
8	120	16 (27)
9	47	11 (21)
10	45	11 (21)
11	44	11 (21)
12	42	11 (21)

Fresh air flow distance for CIVIC EC DB 300

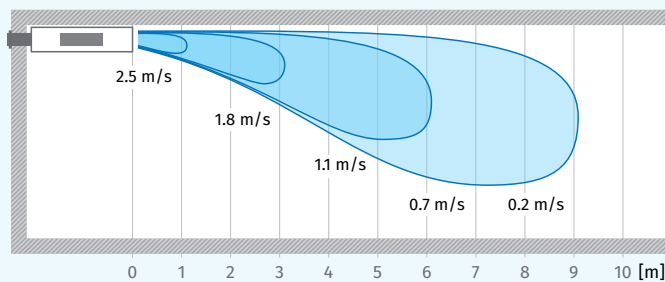

Fresh air flow distance for CIVIC EC DB 500

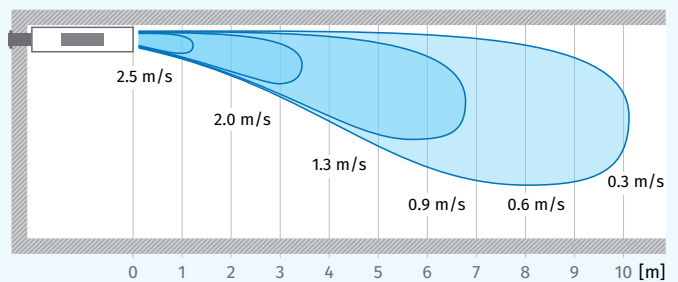

Fresh air flow distance for CIVIC EC DB 1000

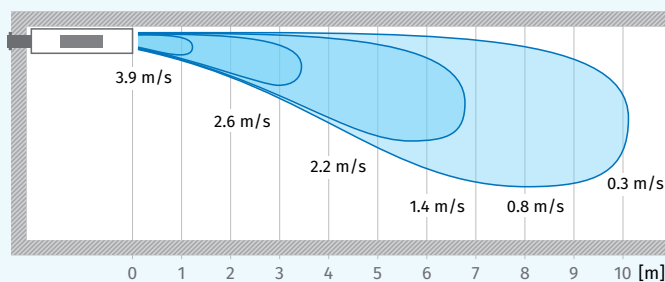

The unit is rated for indoor application with the ambient temperature ranging from +1 °C to +40 °C and relative humidity up to 80%

CIVIC EC DB

SINGLE-ROOM AIR HANDLING UNITS

Overall dimensions [mm]

Model	∅ D	H	H1	H2	H3	L	L1	W	W1	W2	W3
CIVIC EC DB 300 S21	199	333	347	145	188	806	873	1547	196	1155	-
CIVIC EC D1B 300 S21	199	333	399	-	-	1547	1101	1547	196	-	-
CIVIC EC DB 500 S21	249	386	400	169	217	1006	1083	1806	244	1316	-
CIVIC EC D1B 500 S21	249	386	462	-	-	1806	1314	1806	244	-	-
CIVIC EC DB 1000 S21	312	538	563	320	-	1202	1242	2327	420	1295	600

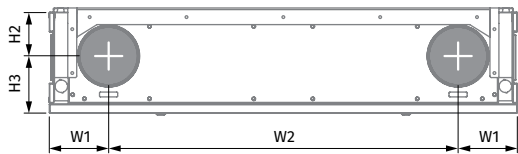
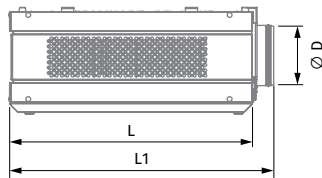
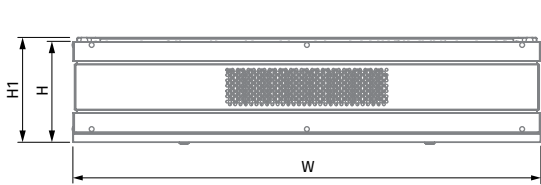

CIVIC EC DB 300 S21 / CIVIC EC DB 500 S21

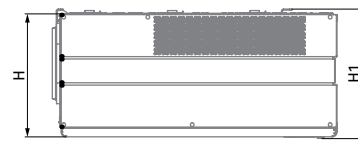
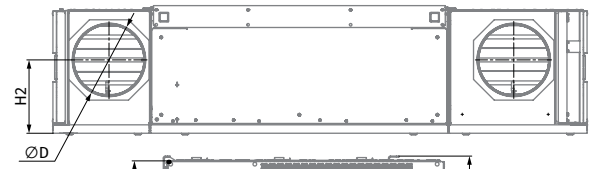
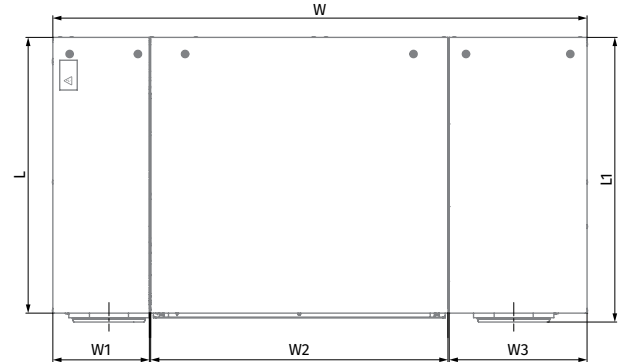



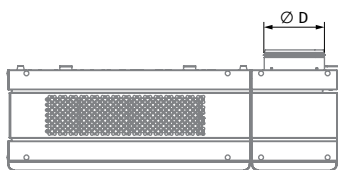
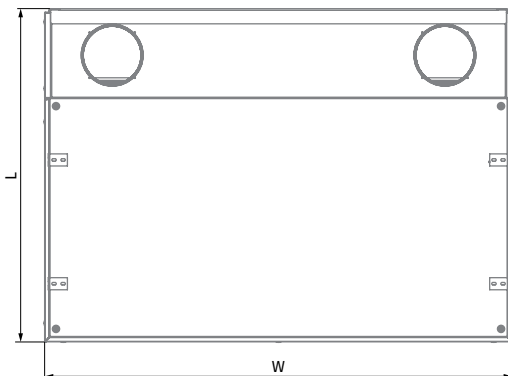
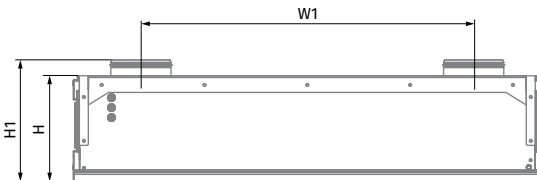











CIVIC EC DB 1000 S21



CIVIC EC D1B 300 S21 / CIVIC EC D1B 500 S21

CIVIC EC DB
SINGLE-ROOM AIR HANDLING UNITS
Accessories

		CIVIC EC DB 300 S21 CIVIC EC DBE 300 S21 CIVIC EC DBE2 300 S21	CIVIC EC DB 500 S21 CIVIC EC DBE 500 S21 CIVIC EC DBE2 500 S21	CIVIC EC DB 1000 S21 CIVIC EC DBE 1000 S21 CIVIC EC DBE2 1000 S21
G4 filter		FP 270x216x48 G4	FP 325x388x48 G4	FP 480x327x48 G4 2 pcs.
G4 filter		FP 270x216x48 G4	FP 325x314x48 G4	FP 480x327x48 G4 2 pcs.
F7 filter		-	-	FP 480x327x48 F7 2 pcs.
F8 filter		FP 270x216x48 F8	FP 325x314x48 F8	-
F8 carbon filter		FP 518x270x48 F8 C	FP 714x320x48 F8 C	-
H11 HEPA filter		FP 518x270x48 H11	FP 714x320x48 H11	-
Outer grill		VDA 200 CFn Al	VDA 250 CFn Al	VDA 315 CFn Al
Control panel		S22	S22	S22
Wi-Fi control panel		S22 Wi-Fi	S22 Wi-Fi	S22 Wi-Fi
LCD Control panel		S25	S25	S25
VOC sensor		DPWQ30600	DPWQ30600	DPWQ30600
CO ₂ sensor		DPWQ40200	DPWQ40200	DPWQ40200
CO ₂ sensor with indication		CD-1	CD-1	CD-1
CO ₂ sensor		CD-2	CD-2	CD-2

CIVIC EC DB

SINGLE-ROOM AIR HANDLING UNITS

		CIVIC EC DB 300 S21 CIVIC EC DBE 300 S21 CIVIC EC DBE2 300 S21	CIVIC EC DB 500 S21 CIVIC EC DBE 500 S21 CIVIC EC DBE2 500 S21	CIVIC EC DB 1000 S21 CIVIC EC DBE 1000 S21 CIVIC EC DBE2 1000 S21
Humidity sensor		DPWC11200	DPWC11200	DPWC11200
Internal humidity sensor		FS2	FS2	FS2
Humidity sensor		HR-S	HR-S	HR-S
Syphon kit		SFK 20x32	SFK 20x32	SFK 20x32
Drain pump		CP-2	CP-2	CP-2

VENTO EXPERT A30 S10 W V.2

HEAT RECOVERY SINGLE-ROOM UNITS

Features

- Arrangement of efficient energy-saving supply and exhaust single-room ventilation in flats, houses, cottages, social and commercial premises.
- Reducing heat losses caused by ventilation due to heat recovery.
- Humidity balance and regulated air exchange create individually controlled microclimate.
- Wi-Fi communication between several single-room ventilation units for coordinated operation.
- Controlled by Android or iOS smartphone or tablet.



Air flow:
up to 30 m³/h
8 l/s



Heat recovery efficiency:
up to 81 %



Power: from 1.8 W
SFP: from 1.06 W/l/s



Noise level:
from 21 dBA



Design

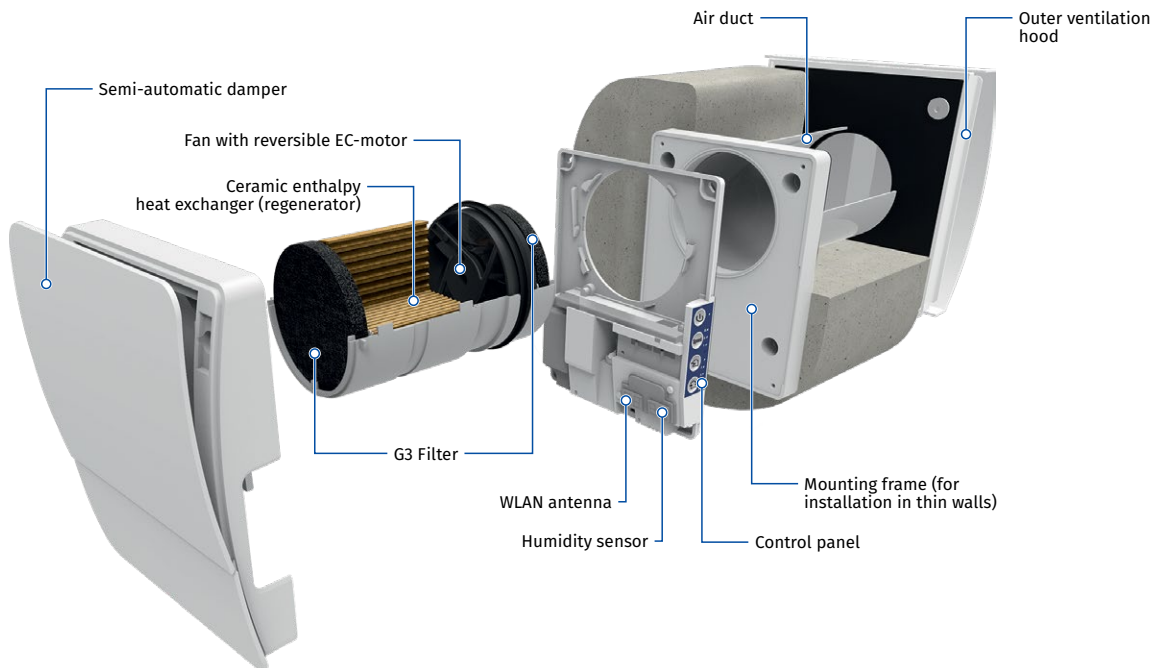

One of the best regeneration efficiency on the market due to innovative hexagonal structure of the heat exchanger cells



Built-in Wi-Fi for wireless communication between units and Android or iOS device control

Designation key

Model	Air duct	Rated air flow [m ³ /h]	Ventilation hood type	Control
Vento Expert	A: round air duct	30	S10: white plastic hood AH-10 white 100	W V.2: control and setup of the unit with the Wi-Fi mobile application

VENTO EXPERT A30 S10 W V.2

HEAT RECOVERY SINGLE-ROOM UNITS

Heat and humidity regeneration

UNIT OPERATING LOGIC IN WINTER PERIOD

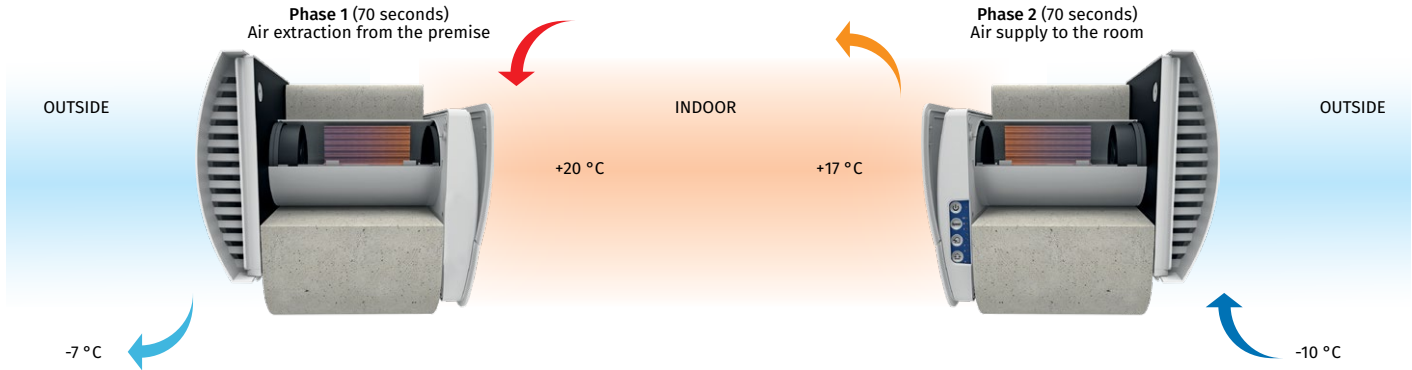

- Warm stale air is extracted from the premise, flows through the ceramic regenerator and transfers its heat energy and moisture to it.
- As the ceramic regenerator gets warmed up, the unit switches to the supply mode.
- Clean cold intake air flows through the regenerator and absorbs accumulated heat and humidity.
- When the ceramic regenerator is cooled down, the unit switches to the extract air mode.

Control

- Control of the unit operation mode is performed by means of smartphone or tablet. Wi-Fi communication between several units for coordinated operation is available.



Blauberg Vento V.2 app for Android or iOS devices is available at Google Play and App Store.

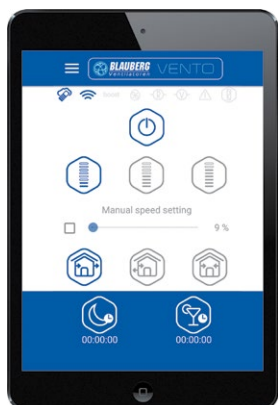

VENTO EXPERT A30 S10 W V.2

HEAT RECOVERY SINGLE-ROOM UNITS

Mounting

- The unit is designed for through-the-wall installation inside a prepared hole in an outer wall of the building.
- The best ventilation solution is pairwise installation of reverse phase synchronized units. Some units ensure supply of fresh air to the room and the other units extract air from the premise. This way the most efficient balanced ventilation is arranged.
- In case of brand new construction, units are mounted in two stages:
 - Pre-installation of an air duct and an outer ventilation hood at the stage of indoor finishing and outer decorative wall finishing.
 - Completion of the installation before commissioning of a house. It includes installation of the indoor unit with controller and air damper, the cartridge, the regenerator, the fan and the filters.

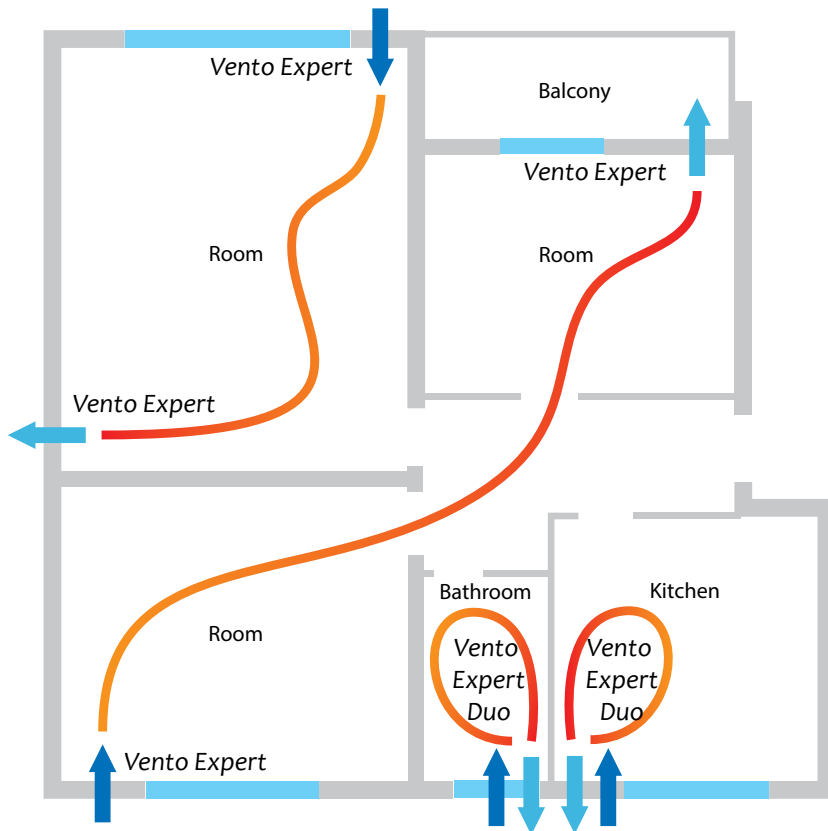

With mounting frame for thin walls



Angular mounting into a wall with standard thickness using **KIT BlauPlast white 100 / KIT BlauPlast chrome 100**

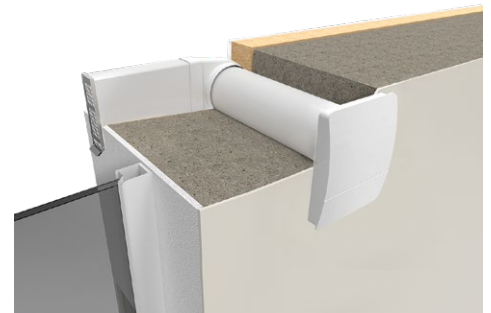

VENTO EXPERT A30 S10 W V.2

HEAT RECOVERY SINGLE-ROOM UNITS

Technical data

Parameters	Vento Expert A30 S10 W V.2		
	I	II	III
Speed		100-240	
Voltage [V / 50 (60) Hz]		3.00	4.40
Power [W]	1.80	0.037	0.051
Current [A]	0.027	2200	2500
RPM [min ⁻¹]	1600	20 (6)	30 (8)
Air flow in ventilation mode [m ³ /h (l/s)]	5 (1)	10 (3)	15 (4)
Air flow in heat recovery mode [m ³ /h (l/s)]	1.30	1.08	1.06
SFP [W/l/s]		G3	
Filter		-15...+40	
Transported air temperature [°C]		37	40
Sound pressure level at 1 m [dBA]	30	28	31
Sound pressure level at 3 m [dBA]	21	42	
Outdoor sound pressure attenuation [dBA] in accordance with DIN EN 20140		D1	
Indoor/outdoor airtightness classification of the complete unit in accordance with EN 13141-8		up to 81	
Heat recovery efficiency in accordance with DIBt LÜ-A 20 [%]		IP24	
Ingress protection rating			

ENERG Y IA IE IA
енергия · енеруєд

BLAUBERG Vento Expert A30 S10 W V.2

A+ A A A B C D E F G

48 dB

15 m³/h

ENERGIA · ЕНЕРГІЯ · ΕΝΕΡΓΕΙΑ · ENERGIA · ENERGY · ENERGIE · ENERGI
2020 1254/2014

Overall dimensions [mm]

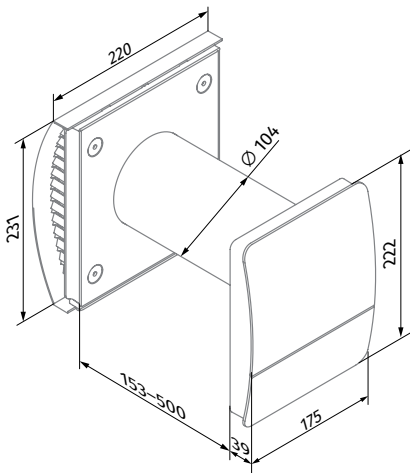

Vento Expert A30 S10 W V.2

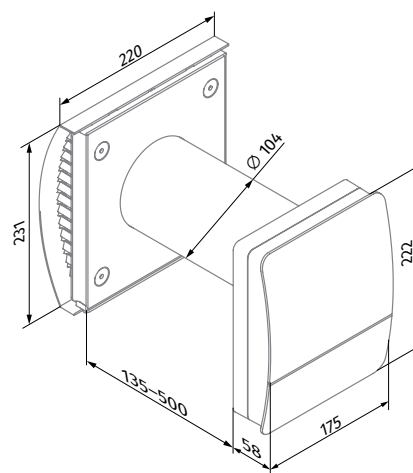































Vento Expert A30 S10 W V.2
(with a mounting frame for thin walls)

VENTO EXPERT A30 S10 W V.2

HEAT RECOVERY SINGLE-ROOM UNITS

Accessories

Name		Description												
Pre-installation Kit Vento Expert A30 S10		Pre-installation kit for mounting into a wall with standard thickness. Includes: <ul style="list-style-type: none"> • Air duct • AH-10 white 100 outer ventilation hood • Plastic foam plug • Plastic foam wedges 												
Completion Kit Vento Expert A30 W V.2		Final mounting kit. Includes: <ul style="list-style-type: none"> • Cartridge with a heat regenerator, a fan and G3 filters • Indoor unit with a controller and air damper 												
FP3 Vento G3		G3 filters (2 pcs.)												
AH-10 *colour* 100		Plastic outer ventilation hood. Available in colours: <table style="display: inline-table; vertical-align: middle;"> <tr> <td></td> <td></td> <td></td> <td></td> <td></td> <td></td> </tr> <tr> <td>white</td> <td>black</td> <td>grey</td> <td>terracotta</td> <td>brown</td> <td>vintage</td> </tr> </table>							white	black	grey	terracotta	brown	vintage
														
white	black	grey	terracotta	brown	vintage									
AH-10 chrome 100		Plastic outer ventilation hood with a plate with brushed stainless steel effect finish												
KIT BlauPlast white 100		Kit for angular mounting with white colour grille (for walls with standard thickness)												
KIT BlauPlast chrome 100		Kit for angular mounting with stainless steel outer grille (for walls with standard thickness)												
BlauPlast RTR 100/0.35-0.5		Telescopic air duct with the diameter of 100 mm and adjustable length from 350 to 500 mm												
BlauPlast RTR 100/0.5-1		Telescopic air duct with the diameter of 100 mm and adjustable length from 500 to 1000 mm												
SE Vento Expert W		Sensor control panel												
CD-1		CO ₂ sensor with LED CO ₂ indication and a sensor button for operation mode selection												
CD-2		CO ₂ sensor												
S Vento Expert A30		Cardboard template for indoor installation of the unit												

VENTO EXPERT A50-1 W V.3

HEAT RECOVERY SINGLE-ROOM UNITS

Features

- Arrangement of efficient energy-saving, supply and exhaust, single-room ventilation in flats, houses, cottages, social and commercial premises.
- Reducing heat losses caused by ventilation due to heat recovery.
- Humidity balance and controllable air exchange create individually controlled micro-climate.
- Wi-Fi data exchange between several single-room ventilation units for coordinated operation.
- Controlled by Android or iOS smartphone or tablet.



Air flow:
up to 50 m³/h
14 l/s



Heat recovery efficiency:
up to 95 %



Power: from 5.0 W
SFP: from 1.22 W/l/s



Noise level:
from 4 dBA



Design

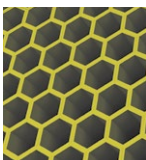
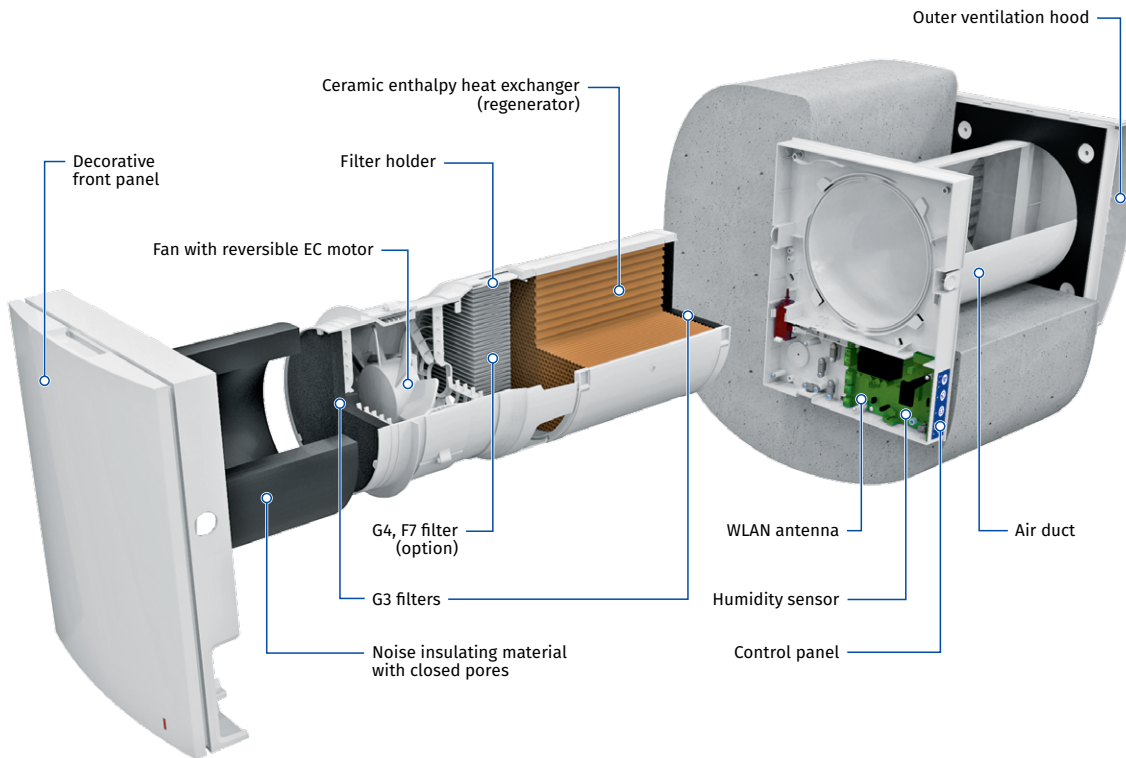

One of the best regeneration efficiency on the market due to innovative hexagonal structure of the heat exchanger cells



Built-in Wi-Fi for wireless communication between units and Android or iOS device control



Integrated automatic air shutters prevent air back drafting



The specially designed front panel can be closed manually to ensure 100 % air tightness and protect against wind impact

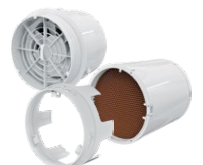

The demountable design of the regenerator cartridge improves heat recovery efficiency and simplifies maintenance

Designation key

Model	Air duct	Rated air flow [m ³ /h]	Front panel	Ventilation hood type	Control
Vento Expert	A: round air duct	50	-1: flat front panel	_ : white plastic hood AH-10 white 160 (for standard walls) S: metal hood (for thin walls)	W V.3: Control and setup of the unit with the Wi-Fi mobile application

VENTO EXPERT A50-1 W V.3

HEAT RECOVERY SINGLE-ROOM UNITS

Control

- Unit control via smartphone or tablet application.
- The units can be connected via Wi-Fi for synchronized operation.
- House ventilation control via cloud service from anywhere in the world.
- Connection to smart house or Building Management System (BMS) via Wi-Fi.

Blauberg Vento V.2 app for Android or iOS devices is available at Google Play and App Store.

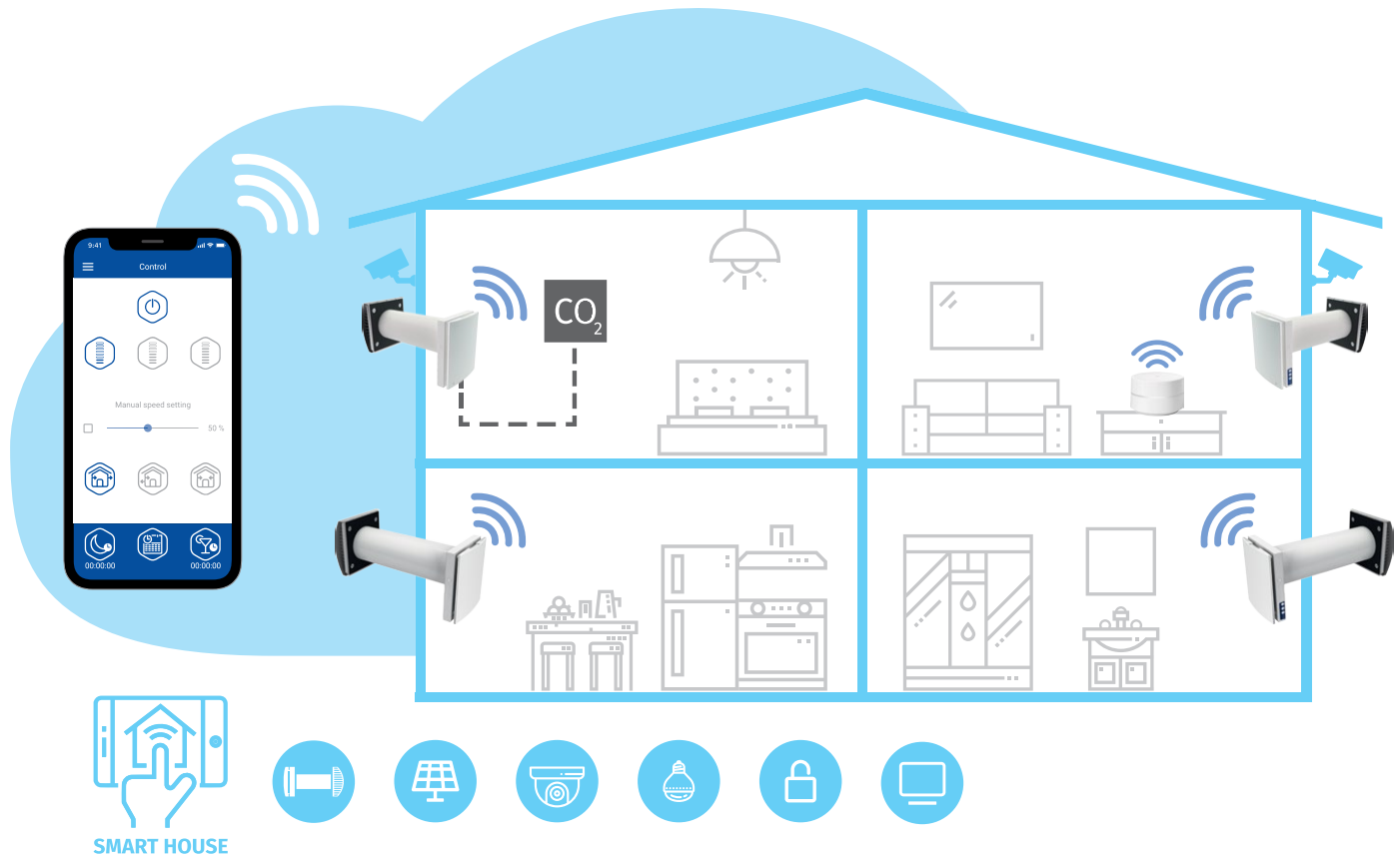

- Vento Expert A50-1 W V.3 either can operate as independent unit or can be connected with other units in a house and controlled with a master unit. In this case, only the master unit receives a signal from the remote control.

- Control of the unit operation mode is also performed by means of the sensor control panel located on the unit casing or the remote control.

FOR LIVING ROOMS AND BEDROOMS



FOR KITCHEN AND BATHROOM

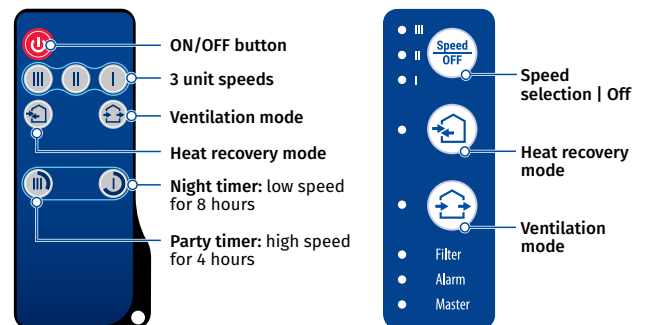

- Vento Expert is equipped with a humidity sensor for indoor humidity control. If humidity increases above a set point, the unit boosts to the speed III.

VENTO EXPERT A50-1 W V.3

HEAT RECOVERY SINGLE-ROOM UNITS

Energy recovery

UNIT OPERATING LOGIC IN WINTER PERIOD

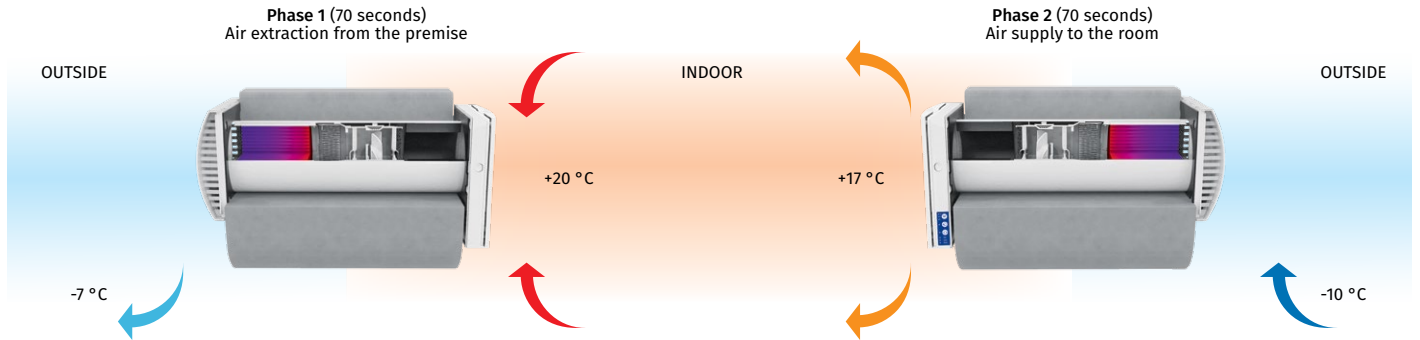

- Warm stale air is extracted from the premise, flows through the ceramic heat exchanger and transfers its heat and moisture to it.
- As the ceramic heat exchanger gets warmed up, the unit switches to the supply mode.
- Clean cold intake air flows through the heat exchanger and absorbs accumulated heat and humidity.
- When the heat exchanger is cooled down, the unit switches to the extract air mode.

Mounting

- The unit is designed for through-the-wall installation inside a prepared hole in an outer wall of the building.
- The best ventilation solution is pairwise installation of reverse phase synchronized units. Some units ensure supply of fresh air to the room and the other units extract air from the premise. This way the most efficient balanced ventilation is arranged.
- In case of brand new construction, units are mounted in two stages:
 - Pre-installation of an air duct and an outer ventilation hood at the stage of indoor finishing and outer decorative wall finishing.
 - Completion of the installation before commissioning of a house. It includes installation of the indoor unit with controller and shutters the cartridge, the heat exchanger, the fan and the filters.

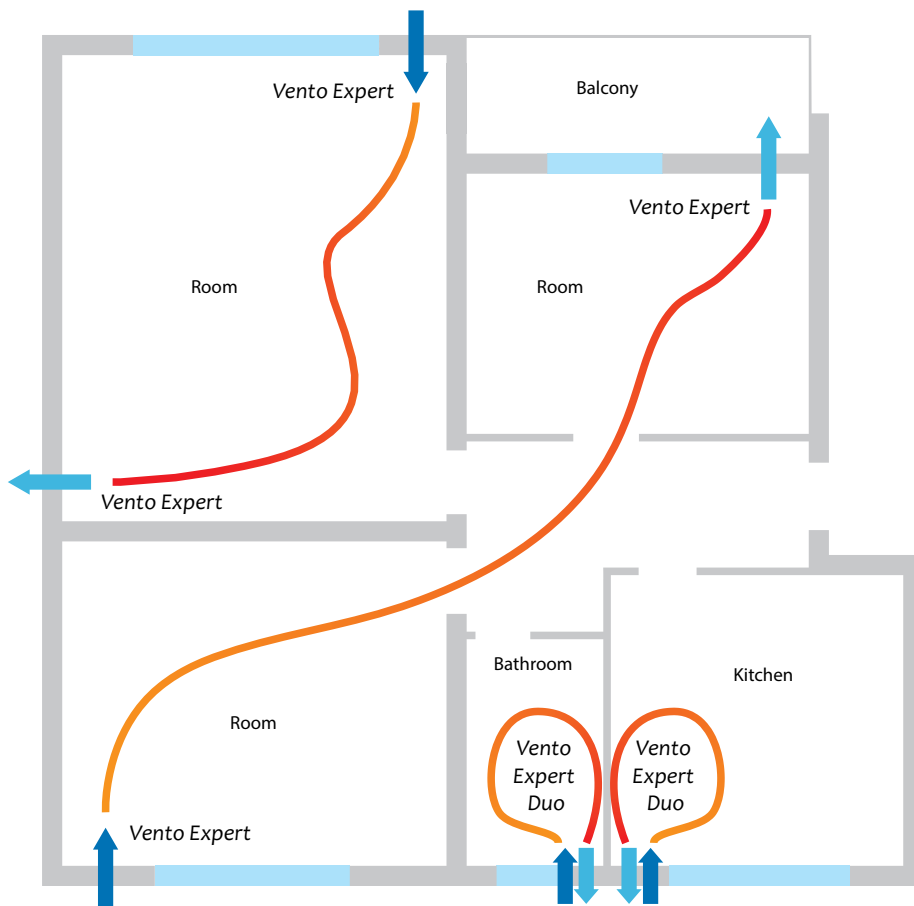

Angular mounting into a wall with standard thickness using
KIT BlauPlast white 160 / KIT BlauPlast chrome 160

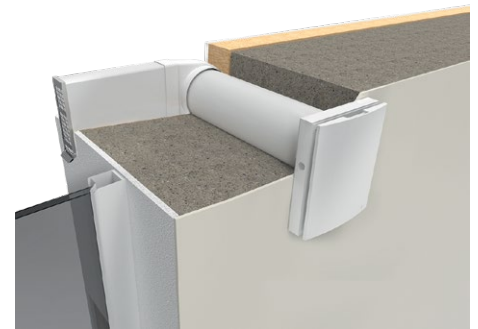

Unit installation example with the hood for thin walls
AH-S grey 160 / AH-S chrome 160

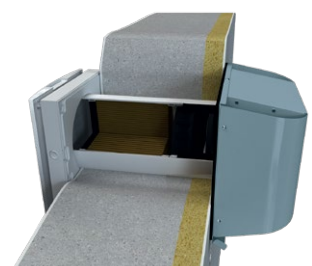

VENTO EXPERT A50-1 W V.3

HEAT RECOVERY SINGLE-ROOM UNITS

Technical data

Parameters	Vento Expert A50-1 W V.3 Vento Expert A50-1 S W V.3		
	I	II	III
Speed			
Voltage [V / 50 (60) Hz]		100-240	
Power [W]	5.0	6.0	8.5
Current [A]	0.035	0.040	0.059
RPM [min ⁻¹]	800	1300	1900
Air flow in ventilation mode [m ³ /h (l/s)]	15 (4)	30 (8)	50 (14)
Air flow in energy recovery mode [m ³ /h (l/s)]	8 (2)	15 (4)	25 (7)
SFP [W/l/s]	2.40	1.23	1.22
Filter	G3 (Option: G4; F7 PM2.5 > 70 %*)		
Transported air temperature [°C]	-20...+40		
Sound pressure level at 1 m in accordance with ISO 3741:2004 [dBA]	13	25	37
Sound pressure level at 3 m in accordance with ISO 3741:2004 [dBA]	4	16	28
Outdoor sound pressure attenuation in accordance with DIN EN 20140 [dBA]	41/47**		
Classification of air flow sensitivity to pressure difference variations in accordance with EN 13141-8	S3***		
Indoor/outdoor airtightness classification of the complete unit in accordance with EN 13141-8	D1		
Heat recovery efficiency in accordance with DIBt LÜ-A 20 [%]	up to 95		
Ingress protection rating	IP24		

* maximum air flow 40 m³/h
 ** with open and closed front panel
 *** manual setting of 100% speed in a mobile application

The energy label displays the following information:

- Energy efficiency class: **A** (indicated by a black arrow pointing to the 'A' class on the scale).
- Sound power level: **47.4 dB** (indicated by a speaker icon).
- Air flow: **25 m³/h** (indicated by an upward and downward arrow icon).
- Energy label scale: A+, A, B, C, D, E, F, G.
- Additional icons: Y, IA, IE, IA.
- Product name: Vento Expert A50-1 W V.3.
- Standards: EN 1254/2014.

Overall dimensions [mm]

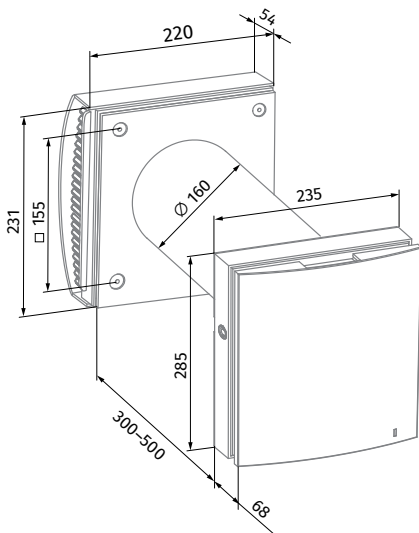

Vento Expert A50-1 W V.3

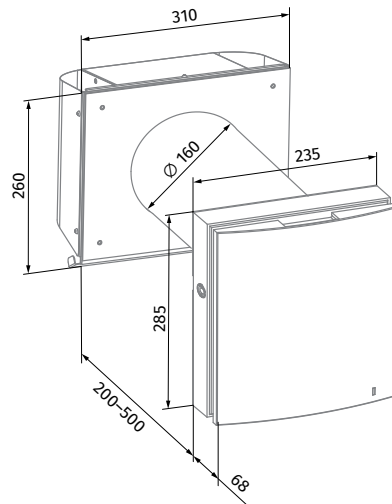













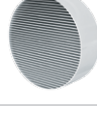

Vento Expert A50-1 S W V.3
(for thin walls)

VENTO EXPERT A50-1 W V.3













HEAT RECOVERY SINGLE-ROOM UNITS

Accessories

Name		Description
Pre-installation Kit Vento Expert A50-1		Pre-installation kit for mounting into walls with standard thickness. Includes: • Air duct • AH-10 white 160 outer ventilation hood • Polystyrene foam plug • Polystyrene foam wedges
Pre-installation Kit Vento Expert A50-1 S		Pre-installation kit for mounting into thin walls. Includes: • Air duct • AH-S chrome 160 outer ventilation hood • Polystyrene foam plug • Polystyrene foam wedges
Completion Kit Vento Expert A50-1 W V.3		Final mounting kit. Includes: • Regenerator module • Fan module • G3 filters (2 pcs.) • Indoor unit with a controller and shutters • Remote control
FP2 Vento G3		G3 filters (2 pcs.)
FP2 Vento G4		Coarse filter. Includes: • Plastic filter holder (1 pc.) • G4 filter (1 pc.).
FPC 150x50 G4		G4 coarse filter
FP2 Vento F7		Filter set. Includes: • Plastic filter holder (1 pc.) • F7 fine filter (1 pc.). Filtration rate PM2.5 > 70 %
FPC 150x50 F7		F7 fine filter. Filtration rate PM2.5 > 70 %
AH-8 white 160		White painted aluminium outer ventilation hood with frost protection for a cold climate
AH-8 chrome 160		Brushed stainless steel outer ventilation hood with frost protection for a cold climate
AH-10 *colour* 160		Plastic outer ventilation hood. Available in colours: 
AH-10 chrome 160		Plastic outer ventilation hood with a plate with brushed stainless steel effect finish
AH-11 *colour* 160		Plastic outer ventilation hood. Available in colours: 

VENTO EXPERT A50-1 W V.3

HEAT RECOVERY SINGLE-ROOM UNITS

Name		Description
AH-S white 160		Stainless steel ventilation hood, painted white
AH-S chrome 160		Brushed stainless steel ventilation hood
PP 160/0.5		Outer ventilation hood for mounting from inside
KIT BlauPlast white 160		Kit for angular mounting with white colour grille (for walls with standard thickness)
KIT BlauPlast chrome 160		Kit for angular mounting with stainless steel outer grille (for walls with standard thickness)
R 160-500		500 mm air duct and polystyrene foam plug
R 160-700		700 mm air duct and polystyrene foam plug
SE Vento Expert W		Sensor control panel
FB Vento Expert A50		Remote control
CD-1		CO ₂ sensor with LED CO ₂ indication and a sensor button for operation mode selection
CD-2		CO ₂ sensor
S Vento Expert A50		Cardboard template for indoor installation of the unit

VENTO EXPERT A50-1 S8 W V.3

HEAT RECOVERY SINGLE-ROOM UNITS

Features

- Extended temperature range up to -30 °C.
- Arrangement of efficient energy-saving, supply and exhaust, single-room ventilation in flats, houses, cottages, social and commercial premises.
- Reducing heat losses caused by ventilation due to heat recovery.
- Humidity balance and controllable air exchange create individually controlled micro-climate.
- Wi-Fi data exchange between several single-room ventilation units for coordinated operation.
- Controlled by Android or iOS smartphone or tablet.



Air flow:
up to 50 m³/h
14 l/s



Heat recovery efficiency:
up to 95 %



Power: from 5.00 W
SFP: from 1.22 W/l/s



Noise level:
from 4 dBA



Operating temperature range:
down to -30 °C



Design

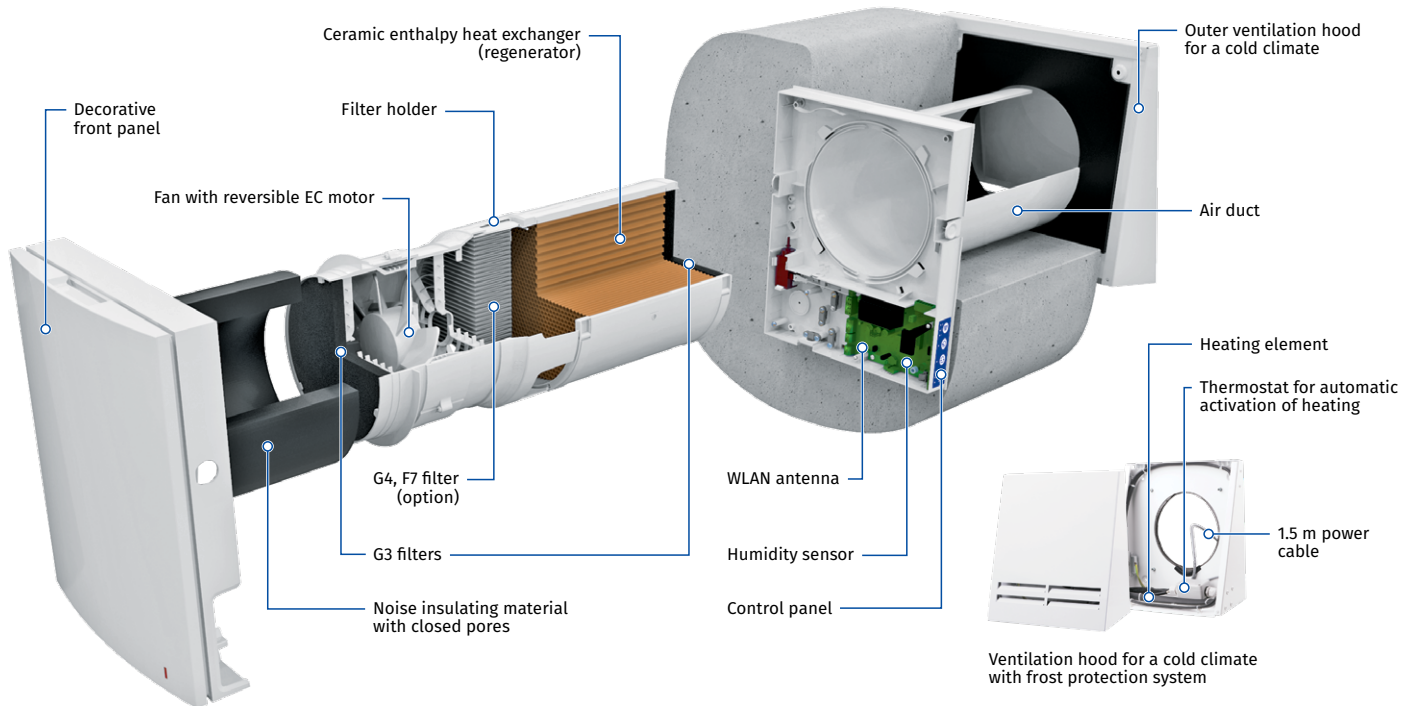

One of the best heat recovery efficiency on the market due to innovative hexagonal structure of the heat exchanger cells



Built-in Wi-Fi for wireless communication between units and Android or iOS device control



Integrated automatic air shutters prevent air back drafting



Easy maintenance. Indoor unit is opened by pressing the latches on both sides. The specially designed front panel can be closed manually to ensure 100 % air tightness and protect against wind impact



The demountable design of the regenerator cartridge improves heat recovery efficiency and simplifies maintenance

Designation key

Model	Air duct	Rated air flow [m ³ /h]	Front panel type	Ventilation hood type	Control
Vento Expert	A: round air duct	50	-1: flat front panel	S8: ventilation hood for a cold climate with frost protection system	W V.3: control and setup of the unit with the Wi-Fi mobile application

VENTO EXPERT A50-1 S8 W V.3

HEAT RECOVERY SINGLE-ROOM UNITS

Control

- Unit control via smartphone or tablet application.
- The units can be connected via Wi-Fi for synchronized operation.
- House ventilation control via cloud service from anywhere in the world.
- Connection to smart house or Building Management System (BMS) via Wi-Fi.

Blauberg Vento V.2 app for Android or iOS devices is available at Google Play and App Store.

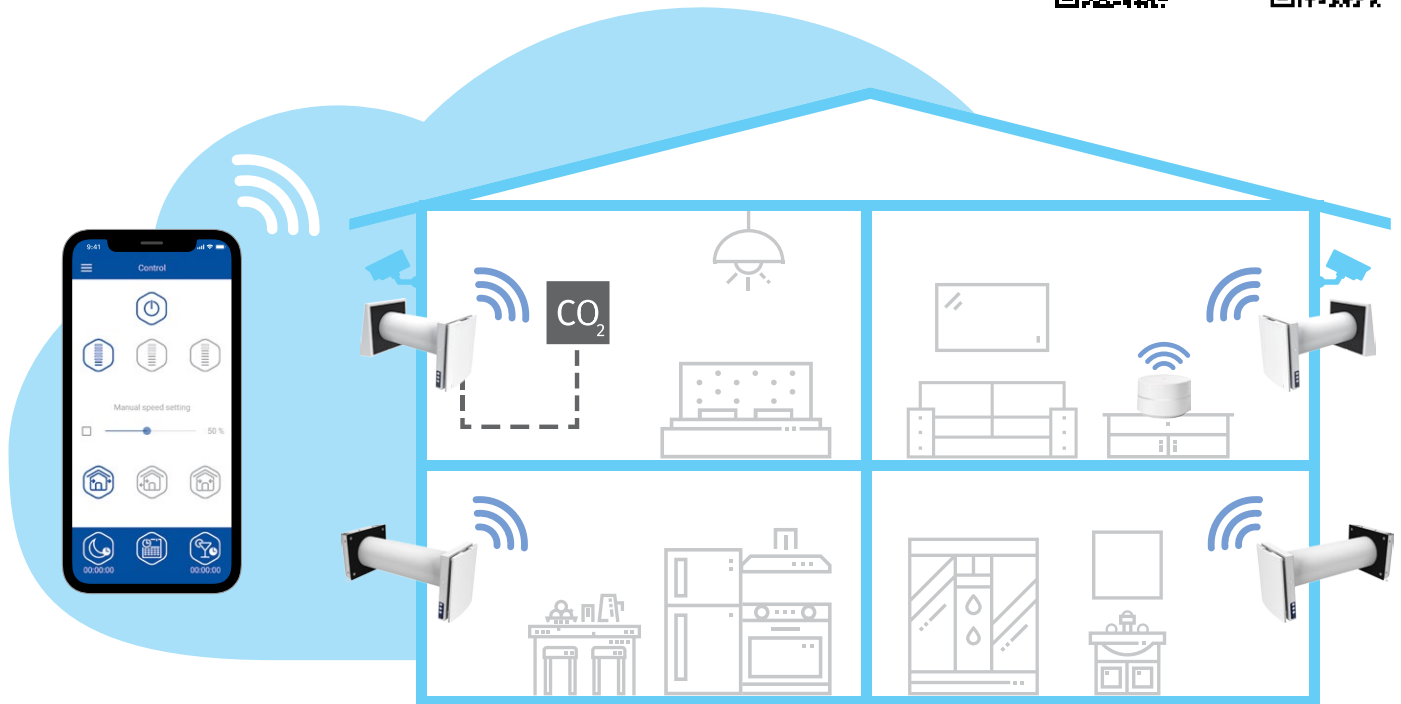

- Vento Expert A50-1 S8 W V.3 either can operate as independent unit or can be connected with other units in a house and controlled with a master unit. In this case, only the master unit receives a signal from the remote control.

- Control of the unit operation mode is also performed by means of the sensor control panel located on the unit casing or the remote control.

FOR LIVING ROOMS AND BEDROOMS

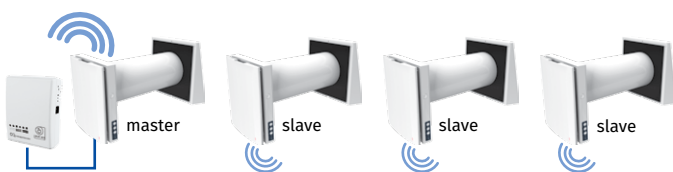

Vento Expert A50-1 S8 W V.3

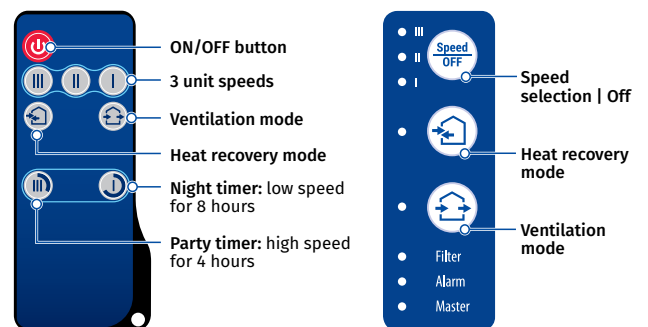

- Vento Expert A50-1 S8 W V.3 is equipped with a humidity sensor for indoor humidity control. If humidity increases above a set point, the unit boosts to the speed III.

VENTO EXPERT A50-1 S8 W V.3

HEAT RECOVERY SINGLE-ROOM UNITS

Energy recovery

UNIT OPERATING LOGIC IN WINTER PERIOD

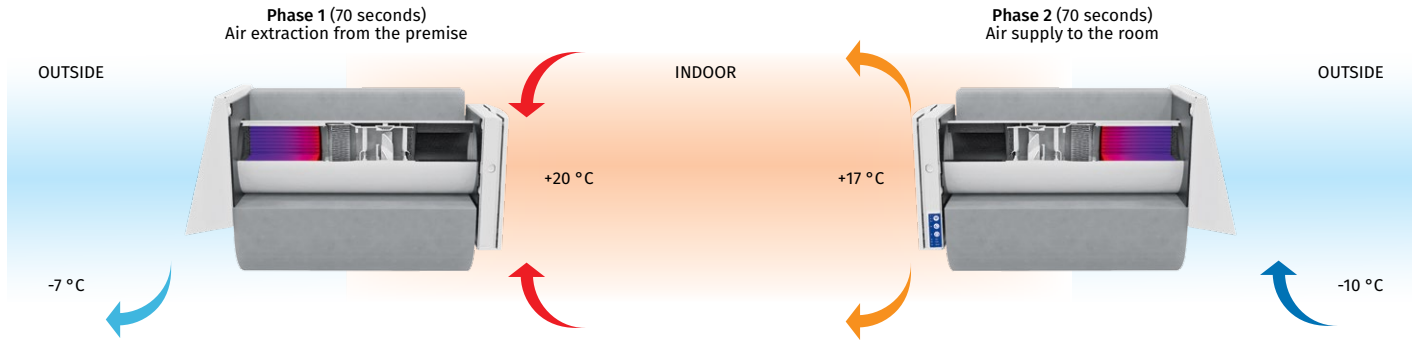

- Warm stale air is extracted from the premise, flows through the ceramic heat exchanger and transfers its heat and moisture to it.
- As the ceramic heat exchanger gets warmed up, the unit switches to the supply mode.

- Clean cold intake air flows through the heat exchanger and absorbs accumulated heat and humidity.
- When the heat exchanger is cooled down, the unit switches to the extract air mode.

Mounting

- The unit is designed for through-the-wall installation inside a prepared hole in an outer wall of the building.
- The best ventilation solution is pairwise installation of reverse phase synchronized units. Some units ensure supply of fresh air to the room and the other units extract air from the premise. This way the most efficient balanced ventilation is arranged.

- In case of brand new construction, units are mounted in two stages:
 - Pre-installation of an air duct and an outer ventilation hood at the stage of indoor finishing and outer decorative wall finishing.
 - Completion of the installation before commissioning of a house. It includes installation of the indoor unit with controller and shutters, the cartridge, the heat exchanger, the fan and the filters.

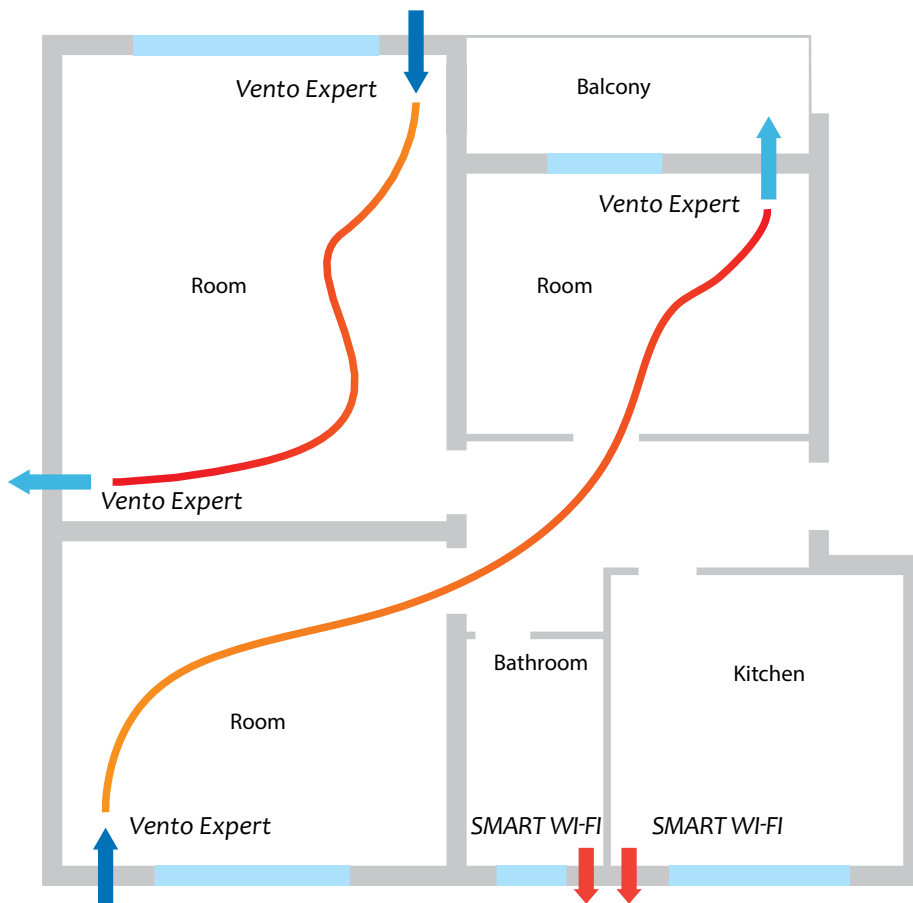

VENTO EXPERT A50-1 S8 W V.3

HEAT RECOVERY SINGLE-ROOM UNITS

Technical data

Parameters	Vento Expert A50-1 S8 W V.3		
	I	II	III
Speed			
Voltage [V / 50 (60) Hz]	100-240		
Power with hood heating element off [W]	5.0	6.0	8.5
Power with hood heating element on [W]	65.0	66.0	68.5
Current with hood heating element off [A]	0.035	0.040	0.059
Current with hood heating element on [A]	0.295	0.300	0.319
RPM [min ⁻¹]	800	1300	1900
Air flow in ventilation mode [m ³ /h (l/s)]	15 (4)	30 (8)	50 (14)
Air flow in energy recovery mode [m ³ /h (l/s)]	8 (2)	15 (4)	25 (7)
SFP [W/l/s]	2.40	1.44	1.22
Filter	G3 (Option: G4; F7 PM2.5 > 70 %*)		
Transported air temperature [°C]	-30...+40		
Sound pressure level at 1 m in accordance with ISO 3741:2004 [dBA]	13	25	37
Sound pressure level at 3 m in accordance with ISO 3741:2004 [dBA]	4	16	28
Outdoor sound pressure attenuation in accordance with DIN EN 20140 [dBA]	41/47**		
Classification of air flow sensitivity to pressure difference variations in accordance with EN 13141-8	S3***		
Indoor/outdoor airtightness classification of the complete unit in accordance with EN 13141-8	D1		
Heat recovery efficiency in accordance with DIBt LÜ-A 20 [%]	up to 95		
Ingress protection rating	IP24		

* maximum air flow 40 m³/h

** with open and closed front panel

*** manual setting of 100% speed in a mobile application

The energy label displays the following information:

- Energy efficiency class: **A** (indicated by a black arrow pointing to the 'A' class on the scale).
- Sound power level: **47.4 dB** (indicated by a speaker icon).
- Air flow: **25 m³/h** (indicated by two arrows pointing up and down).
- Additional markings include the European Union flag, the 'ENERGY' logo in multiple languages, and the model name 'Vento Expert A50-1 S8 W V.3'.

Overall dimensions [mm]

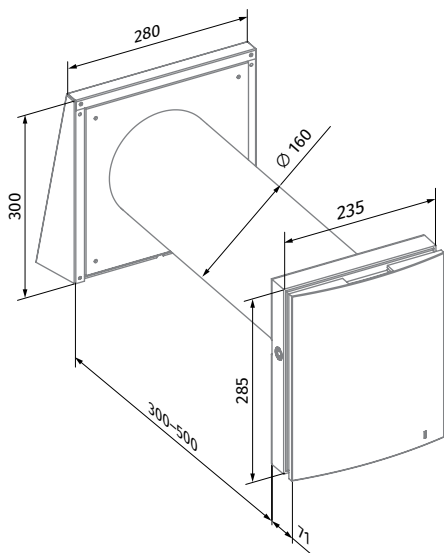













Vento Expert A50-1 S8 W V.3

VENTO EXPERT A50-1 S8 W V.3



HEAT RECOVERY SINGLE-ROOM UNITS

Accessories

Name		Description
Pre-installation Kit Vento Expert A50-1 S8		Pre-installation kit for mounting into walls with standard thickness. Includes: • Air duct • AH-8 white 160 outer ventilation hood • Polystyrene foam plug • Polystyrene foam wedges
Completion Kit Vento Expert A50C3-1 W V.3		Final mounting kit. Includes: • Regenerator module • Fan module • G3 filters (2 pcs.) • Indoor unit with a controller and shutters • Remote control
FP2 Vento G3		G3 filters (2 pcs.)
FP2 Vento G4		Coarse filter. Includes: • Plastic filter holder (1 pc.) • G4 filter (1 pc.).
FPC 150x50 G4		G4 coarse filter
FP2 Vento F7		Filter set. Includes: • Plastic filter holder (1 pc.) • F7 fine filter (1 pc.). Filtration rate PM2.5 > 70 %
FPC 150x50 F7		F7 fine filter. Filtration rate PM2.5 > 70 %
AH-8 white 160		White painted aluminium outer ventilation hood with frost protection for a cold climate
AH-8 chrome 160		Brushed stainless steel outer ventilation hood with frost protection for a cold climate
R 160-500		500 mm air duct and polystyrene foam plug
R 160-700		700 mm air duct and polystyrene foam plug
SE Vento Expert W		Sensor control panel
FB Vento Expert A50		Remote control

VENTO EXPERT A50-1 S8 W V.3

HEAT RECOVERY SINGLE-ROOM UNITS

Name		Description
CD-1		CO ₂ sensor with LED CO ₂ indication and a sensor button for operation mode selection
CD-2		CO ₂ sensor
S Vento Expert A50		Cardboard template for indoor installation of the unit

VENTO EXPERT A100-1 S10 W V.2

HEAT RECOVERY SINGLE-ROOM UNITS

Features

- Arrangement of efficient energy-saving, supply and exhaust, single-room ventilation in flats, houses, cottages, social and commercial premises.
- Reducing heat losses caused by ventilation due to heat recovery.
- Humidity balance and controllable air exchange create individually controlled micro-climate.
- Wi-Fi data exchange between several single-room ventilation units for coordinated operation.
- Controlled by Android or iOS smartphone or tablet.
- Connection to smart house or Building Management System (BMS).



Air flow:
up to 108 m³/h
30 l/s



Heat recovery efficiency:
up to 87 %



Power: from 3.2 W
SFP: from 0.82 W/l/s



Noise level:
from 13 dBA



Design

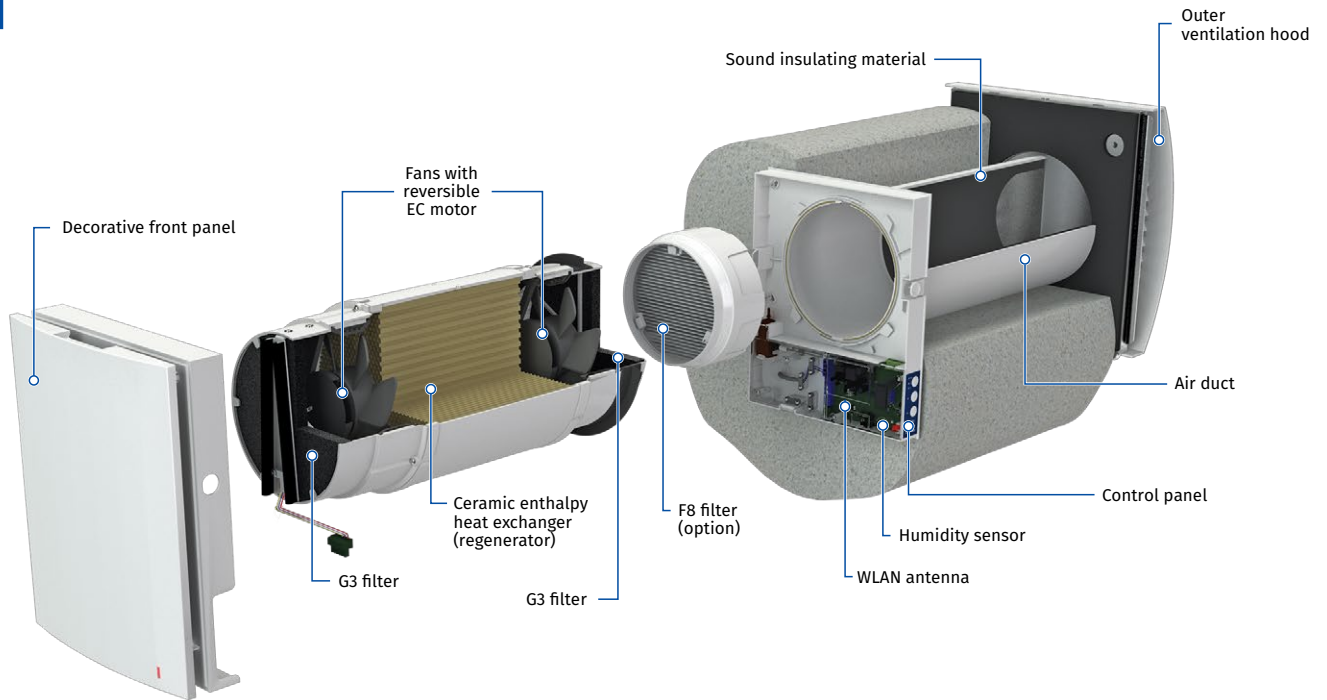

One of the best heat recovery efficiency on the market due to innovative hexagonal structure of the heat exchanger cells



Built-in Wi-Fi for wireless communication between units and Android or iOS device control



Integrated automatic air shutters prevent air back drafting



Easy maintenance. Indoor unit is opened by pressing the latches on both sides. The specially designed front panel can be closed manually to ensure 100 % air tightness and protect against wind impact

Designation key

Model	Air duct	Rated air flow [m ³ /h]	Unit modification	Ventilation hood type	Control
Vento Expert	A: round air duct	100	-1	S10: plastic outer ventilation hood AH-10 white 160 (for standard walls) S: metal hood (for thin walls)	W V.2: control and setup of the unit with the Wi-Fi mobile application

VENTO EXPERT A100-1 S10 W V.2

HEAT RECOVERY SINGLE-ROOM UNITS

Control

- Unit control via smartphone or tablet application.
- The units can be connected via Wi-Fi for synchronized operation.
- House ventilation control via cloud service from anywhere in the world.
- Connection to smart house or Building Management System (BMS) via Wi-Fi.

Blauberg Vento V.2 app for Android or iOS devices is available at Google Play and App Store.

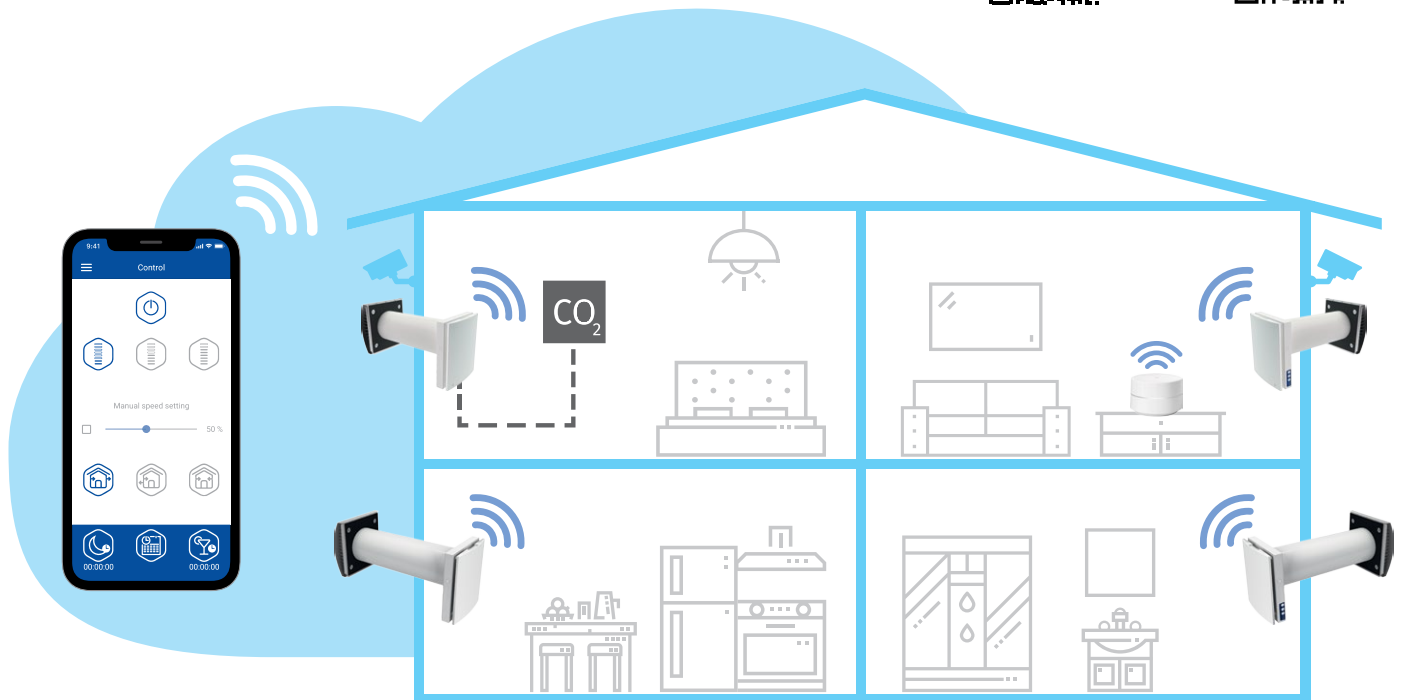

- Vento Expert A100-1 S10 W V.2 either can operate as independent unit or can be connected with other units in a house and controlled with a master unit. In this case, only the master unit receives a signal from the remote control.

- Control of the unit operation mode is also performed by means of the sensor control panel located on the unit casing or the remote control.

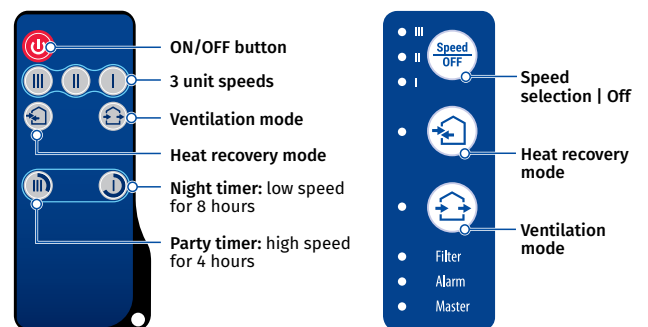

- Vento Expert A100-1 S10 W V.2 is equipped with a humidity sensor for indoor humidity control. If humidity increases above a set point, the unit boosts to the speed III.

VENTO EXPERT A100-1 S10 W V.2

HEAT RECOVERY SINGLE-ROOM UNITS

Energy recovery

UNIT OPERATING LOGIC IN WINTER PERIOD

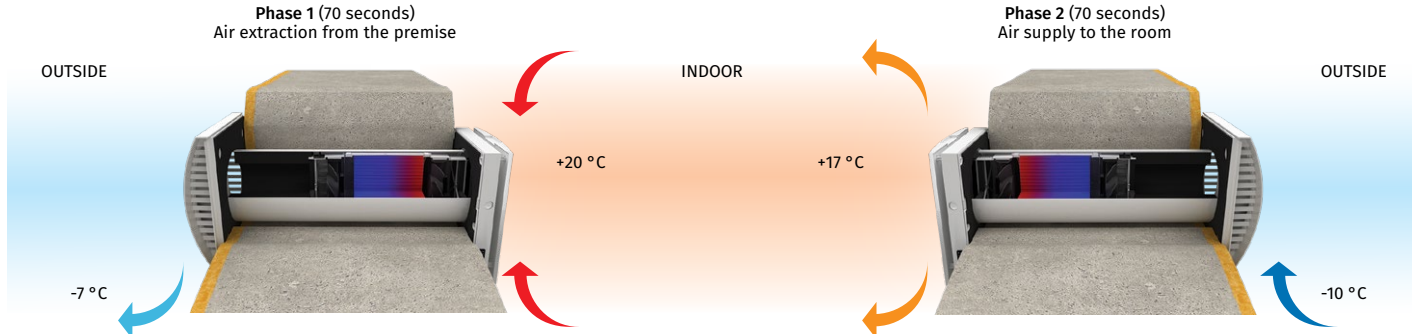

- Warm stale air is extracted from the premise, flows through the ceramic heat exchanger and transfers its heat and moisture to it.
- As the ceramic heat exchanger gets warmed up, the unit switches to the supply mode.
- Clean cold intake air flows through the heat exchanger and absorbs accumulated heat and humidity.
- When the heat exchanger is cooled down, the unit switches to the extract air mode.

Mounting

- The unit is designed for through-the-wall installation inside a prepared hole in an outer wall of the building.
- The best ventilation solution is pairwise installation of reverse phase synchronized units. Some units ensure supply of fresh air to the room and the other units extract air from the premise. This way the most efficient balanced ventilation is arranged.
- The Vento **Expert A100-1 W V.2** unit can also be installed in a bathroom and kitchen, if allowed by local building codes. Otherwise, the **Vento Expert Duo** unit or an extract fan should be installed.

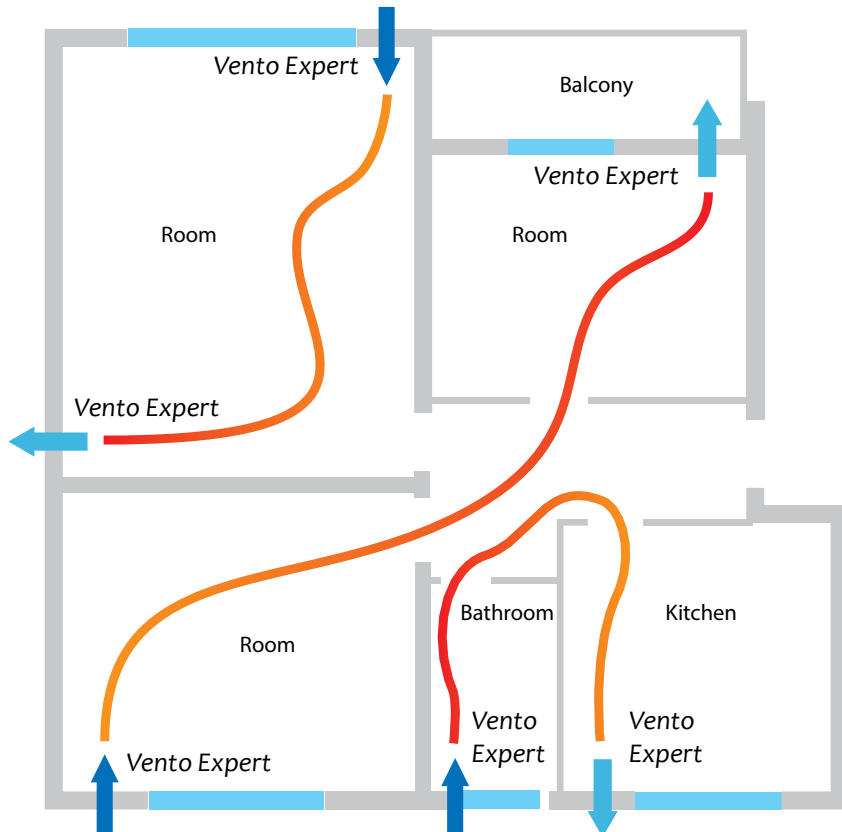

Angular mounting into a wall with standard thickness using **KIT BlauPlast white 160 / KIT BlauPlast chrome 160**

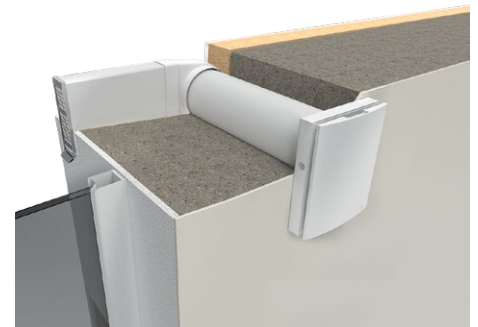

Unit installation example with the hoods for thin walls **AH-S grey 160 / AH-S chrome 160**

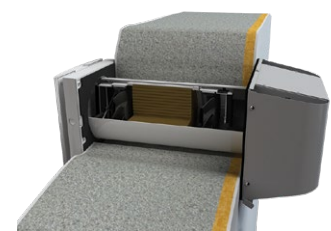

VENTO EXPERT A100-1 S10 W V.2

HEAT RECOVERY SINGLE-ROOM UNITS

Technical data

Parameters	Vento Expert A100-1 S10 W V.2 Vento Expert A100-1 S W V.2			
	I	II	III	MAX
Speed				
Voltage [V / 50 (60) Hz]	100-240			
Power [W]	3.20	4.00	6.60	18.00
Current [A]	0.037	0.046	0.071	0.151
RPM [min ⁻¹]	780	1100	1920	2940
Air flow in ventilation mode [m ³ /h (l/s)]	18(5)	30 (8)	58 (16)	108 (30)
Air flow in energy recovery mode [m ³ /h (l/s)]	9 (3)	15 (4)	29 (8)	54 (15)
SFP [W/l/s]	1.28	0.96	0.82	1.20
Filter	G3 (Option: F8 PM2.5 > 99 %*)			
Transported air temperature [°C]	-20...+40			
Sound pressure level at 1 m in accordance with ISO 3741:2004 [dBA]	23	27	40	51
Sound pressure level at 3 m in accordance with ISO 3741:2004 [dBA]	13	18	30	42
Outdoor sound pressure attenuation in accordance with DIN EN 20140 [dBA]	42			
Indoor/outdoor airtightness classification of the complete unit in accordance with EN 13141-8	D1			
Heat recovery efficiency in accordance with DIBt LÜ-A 20 [%]	up to 87			
Ingress Protection Rating	IP24			

* maximum air flow 82 m³/h

ENERGY LABEL: A (Energy efficiency), 50 dB (Sound power level), 54 m³/h (Air flow)

Overall dimensions [mm]

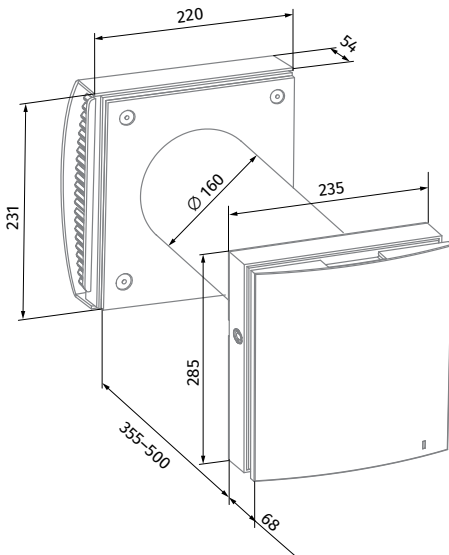

Vento Expert A100-1 S10 W V.2

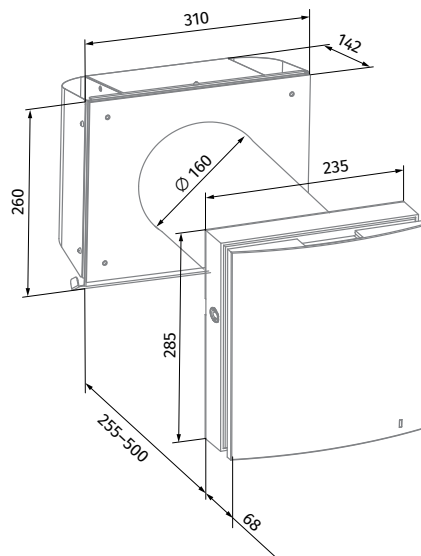











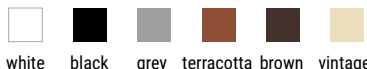



Vento Expert A100-1 S W V.2
(for thin walls)

VENTO EXPERT A100-1 S10 W V.2





HEAT RECOVERY SINGLE-ROOM UNITS

Accessories

Name		Description
FP2 Vento G3		G3 filters (2 pcs.)
FP2 Vento F8		Filter set. Includes: • Plastic frame (1 pc.) • G2 pre-filter (1 pc.) • F8 filter (1 pc.). Filtration rate PM2.5 > 99 %
AH-10 *colour* 160		Plastic outer ventilation hood. Available in colours: 
AH-10 chrome 160		Plastic outer ventilation hood with a plate with brushed stainless steel effect finish
AH-11 *colour* 160		Plastic outer ventilation hood. Available in colours: 
AH-S grey 160		Stainless steel ventilation hood, painted grey
AH-S chrome 160		Brushed stainless steel ventilation hood
PP 160/0.5		Outer ventilation hood for mounting from inside
KIT BlauPlast white 160		Kit for angular mounting with white colour grille (for walls with standard thickness)
KIT BlauPlast chrome 160		Kit for angular mounting with stainless steel outer grille (for walls with standard thickness)
R 160-500		500 mm air duct and polystyrene foam plug
R 160-700		700 mm air duct and polystyrene foam plug
SE Vento Expert W		Sensor control panel

VENTO EXPERT A100-1 S10 W V.2

HEAT RECOVERY SINGLE-ROOM UNITS

Name		Description
FB Vento Expert A50		Remote control
CD-1		CO ₂ sensor with LED CO ₂ indication and a sensor button for operation mode selection
CD-2		CO ₂ sensor
S Vento Expert A50		Cardboard template for indoor installation of the unit

VENTO EXPERT DUO A30-1 S10 W V.2

HEAT RECOVERY SINGLE-ROOM UNITS

Features

- Arrangement of balanced energy saving, supply and exhaust, single-room ventilation in kitchen, bathroom and utility rooms.
- Reducing heat losses caused by ventilation due to heat recovery.
- Humidity balance and controllable air exchange create individually controlled microclimate.
- Wi-Fi data exchange between several single-room ventilation units for coordinated operation.
- Controlled by Android or iOS smartphone or tablet.



Air flow:
up to 30 m³/h
8 l/s



Heat recovery efficiency:
up to 85 %



Power: from 2.17 W
SFP: from 0.66 W/l/s



Noise level:
from 24 dBA



Dear partners! Please note that as of the end of the third quarter of 2020, in order to increase the efficiency of the Vento Expert Duo, the company manufactures products with regenerators divided into two sections.

Design

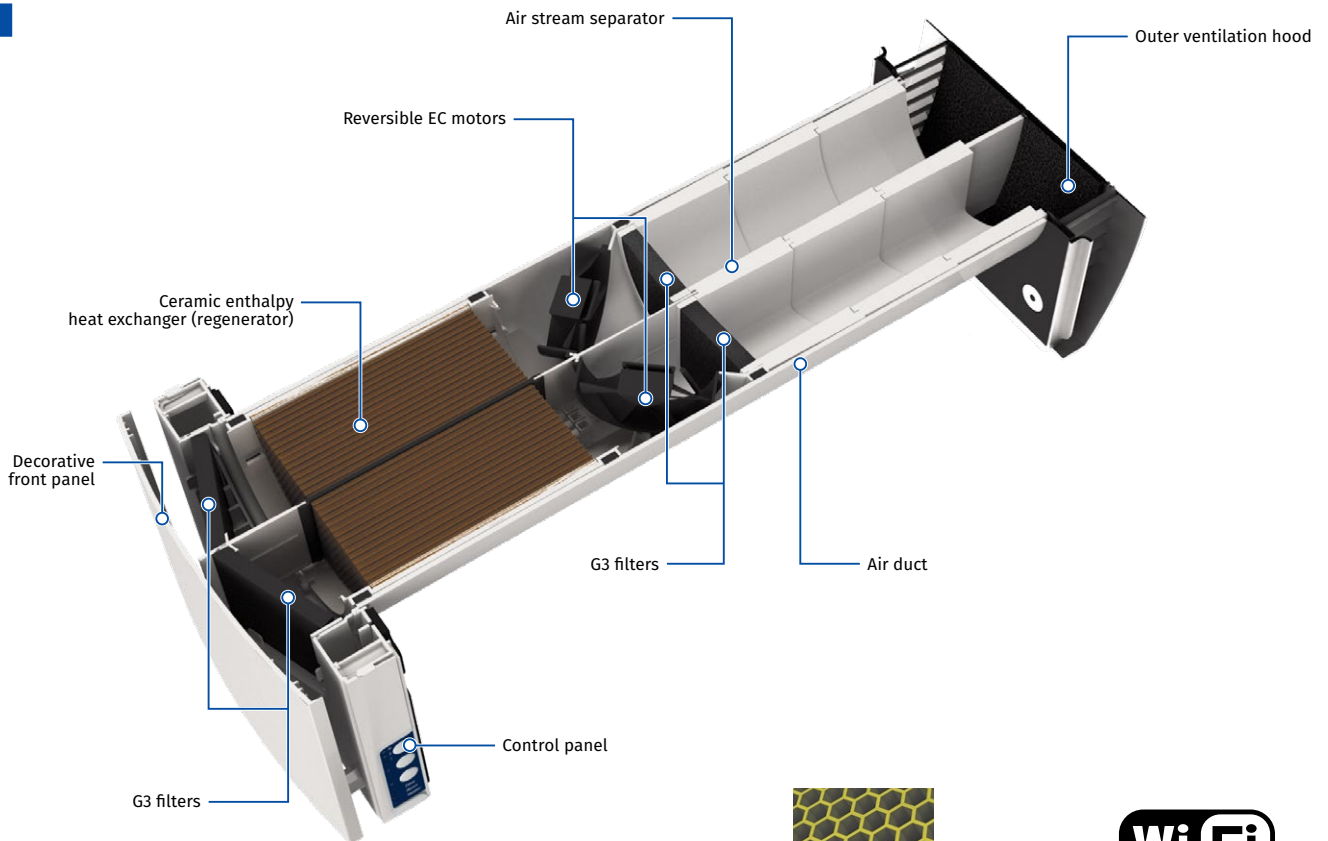

One of the best regeneration efficiency on the market due to innovative hexagonal structure of the heat exchanger cells



Built-in Wi-Fi for wireless communication between units and Android or iOS device control

Designation key

Model	Fans	Air duct	Rated air flow [m ³ /h]	Front panel	Ventilation hood type	Control
Vento Expert	Duo: two fans with different rotation direction	A: round air duct	30	-1: flat front panel	S10: white plastic hood AH-10 white 160 Duo	W V.2: control and setup of the unit with the Wi-Fi mobile application

VENTO EXPERT DUO A30-1 S10 W V.2

HEAT RECOVERY SINGLE-ROOM UNITS

Control

- Unit control via smartphone or tablet application.
- The units can be connected via Wi-Fi for synchronized operation.
- House ventilation control via cloud service from anywhere in the world.
- Connection to smart house or Building Management System (BMS) via Wi-Fi.

Blauberg Vento V.2 app for Android or iOS devices is available at Google Play and App Store.

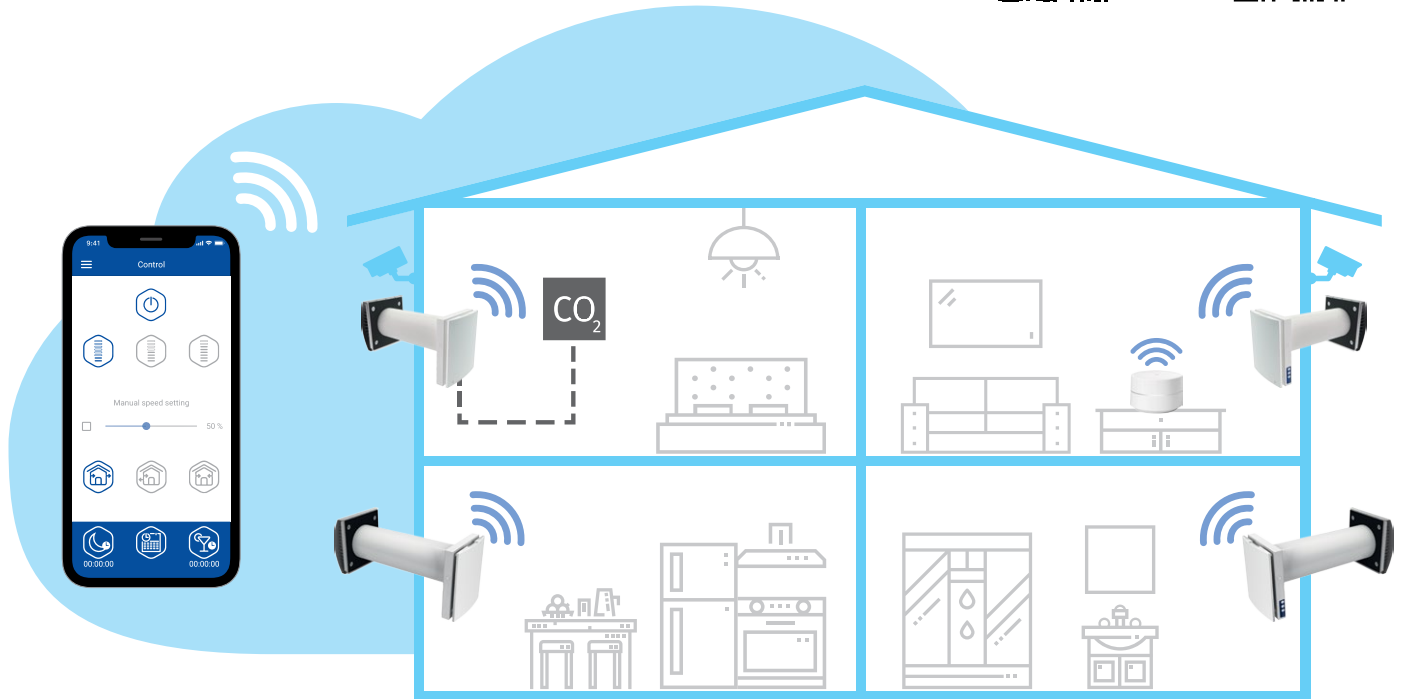

SMART HOUSE



Vento Expert Duo either can operate as independent unit or can be connected with other units in a house and controlled with a master unit. In this case, only the master unit receives a signal from the remote control.

Control of the unit operation mode is also performed by means of the sensor control panel located on the unit casing or the remote control.

FOR LIVING ROOMS AND BEDROOMS



FOR KITCHEN AND BATHROOM



Vento Expert is equipped with a humidity sensor for indoor humidity control. If humidity increases above a set point, the unit boosts to the speed III.

VENTO EXPERT DUO A30-1 S10 W V.2

HEAT RECOVERY SINGLE-ROOM UNITS

Heat and humidity recovery

UNIT OPERATING LOGIC IN WINTER PERIOD

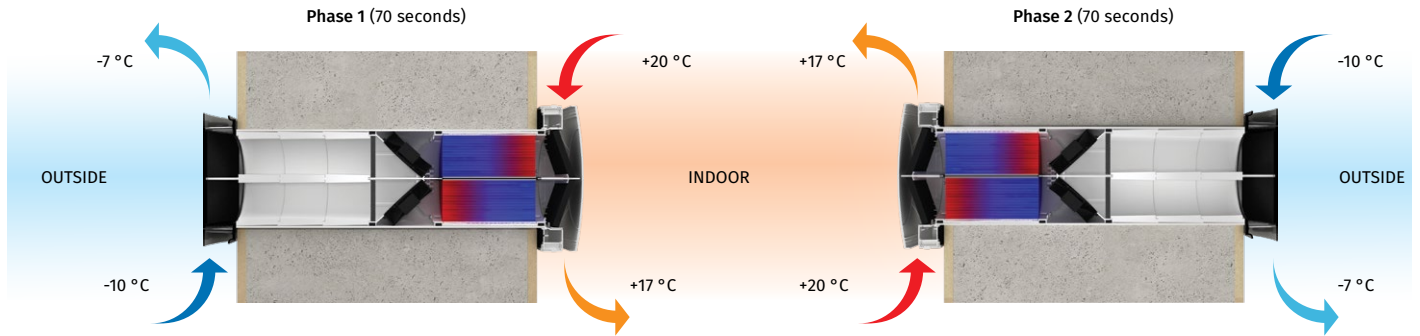

- To increase the efficiency of the Vento Expert Duo, the regenerator is divided into two parts, which are isolated from one another, thus eliminating the transfer of heat and moisture between them.
- One of the fans operates in the supply mode: fresh cold intake air from outside flows through the first regenerator, and absorbs accumulated heat and humidity.
- At the same time, the other fan operates in the exhaust mode: warm stale air is extracted from the room to the outside, and while passing through the other regenerator, gradually heats it up and transfers some of the moisture.
- After 70 seconds operation the fans change the rotation direction and opposite processes start.

Mounting

- **Vento Expert** units should be installed in the living room and bedrooms while **Vento Expert Duo** units should be installed in kitchen, bathrooms and utility rooms.
- The unit is designed for through-the-wall installation inside a prepared hole in an outer wall of the building.

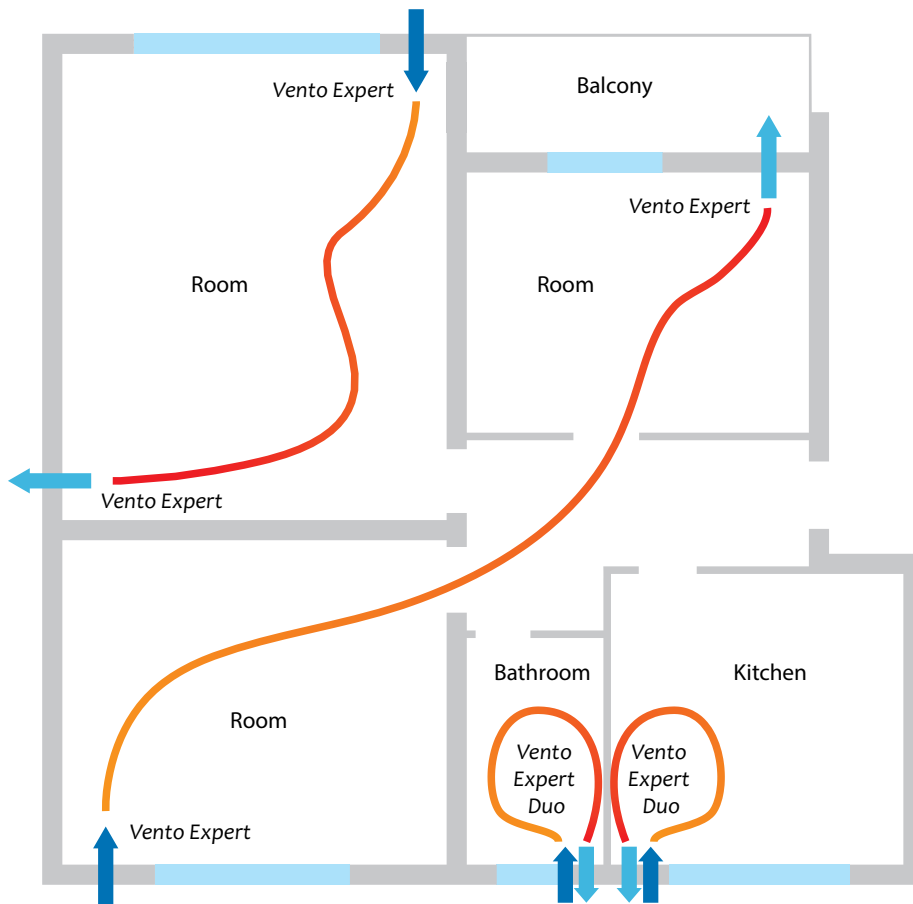

VENTO EXPERT DUO A30-1 S10 W V.2

HEAT RECOVERY SINGLE-ROOM UNITS

Technical data

Parameters	Vento Expert Duo A30-1 S10 W V.2		
	I	II	III
Speed			
Voltage [V / 50 (60) Hz]		100-240	
Power [W]	2.17	3.66	6.62
Current [A]	0.026	0.039	0.066
RPM [min ⁻¹]	1600	2200	2500
Air flow [m ³ /h (l/s)]	10 (3)	20 (6)	30 (8)
Air flow in humidity extract mode [m ³ /h (l/s)]		60 (16)	
SFP [W/l/s]	0.78	0.66	0.79
Filter		G3	
Transported air temperature [°C]		-15...+40	
Sound pressure level at 1 m in accordance with ISO 3741:2004 [dBA]	33	40	43
Sound pressure level at 3 m in accordance with ISO 3741:2004 [dBA]	24	31	34
Outdoor sound pressure attenuation in accordance with DIN EN 20140 [dBA]		42	
Indoor/outdoor airtightness classification of the complete unit in accordance with EN 13141-8		D2	
Heat recovery efficiency in accordance with DIBt LÜ-A 20 [%]		up to 85	
Ingress protection rating		IP24	

ENERG
енергия · ενεργεια
Y IA
IE 1A

BLAUBERG Vento Expert Duo A30-1 S10 W V.2

A+

A

B

C

D

E

F

G

A

51 dB

30 m³/h

ENERGIA · ЕНЕРГИЯ · ΕΝΕΡΓΕΙΑ · ENERGIA · ENERGY · ENERGIE · ENERGI
2020 1254/2014

Overall dimensions [mm]

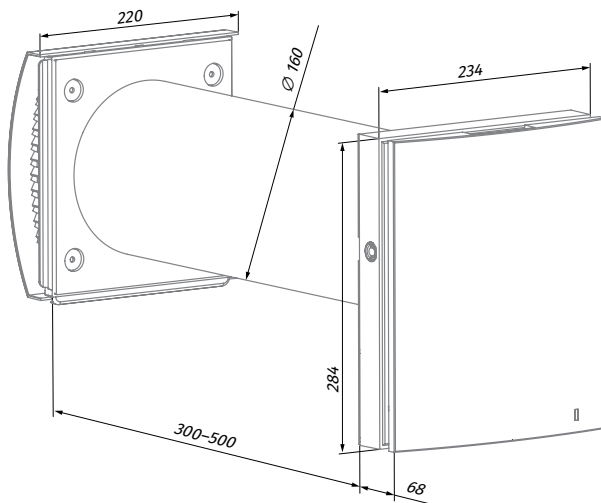















Vento Expert Duo A30-1 S10 W V.2

VENTO EXPERT DUO A30-1 S10 W V.2



HEAT RECOVERY SINGLE-ROOM UNITS

Accessories

Name		Description
FP Vento Expert Duo A30 G3		G3 filter set. Includes: • Rectangular filter G3 (2 pcs.) • Semicircular filter G3 (2 pcs.)
FP1 Vento Expert Duo A30 G3		G3 filter set. Includes: • Rectangular filter G3 (2 pcs.) • Semicircular filter G3 (2 pcs.) • Plastic filter holder (2 pcs.)
AH-10 *colour* 160 Duo		Plastic outer ventilation hood. Available in colours: 
AH-10 chrome 160 Duo		Plastic outer ventilation hood with a plate with brushed stainless steel effect finish
AH-5 white 160 Duo		Stainless steel ventilation hood, painted white
AH-5 chrome 160 Duo		Brushed stainless steel ventilation hood
PP 160/0.5		Outer ventilation hood for mounting from inside
R 160-500		500 mm air duct and polystyrene foam plug
R 160-700		700 mm air duct and polystyrene foam plug
LST Vento Expert Duo		Air stream separator
SE Vento Expert W		Sensor control panel
FB Vento Expert A50		Remote control
CD-1		CO ₂ sensor with LED CO ₂ indication and a sensor button for operation mode selection

VENTO EXPERT DUO A30-1 S10 W V.2

HEAT RECOVERY SINGLE-ROOM UNITS

Name	Description
CD-2	 CO ₂ sensor
S Vento Expert A30	 Cardboard template for indoor installation of the unit

VENTO EXPERT A50-1 PRO V.3

HEAT RECOVERY SINGLE-ROOM UNITS

Features

- Arrangement of efficient energy-saving supply and exhaust single-room ventilation in flats, houses, cottages, social and commercial premises.
- Reducing heat losses caused by ventilation due to heat recovery.
- Humidity balance and regulated air exchange create individually controlled microclimate.
- Coordinated network based on several integrated single-room ventilation units with central control.



Air flow:
up to 50 m³/h
14 l/s



Heat recovery efficiency:
up to 95 %



Power: from 5.0 W
SFP: from 1.22 W/l/s



Noise level:
from 4 dBA



Design

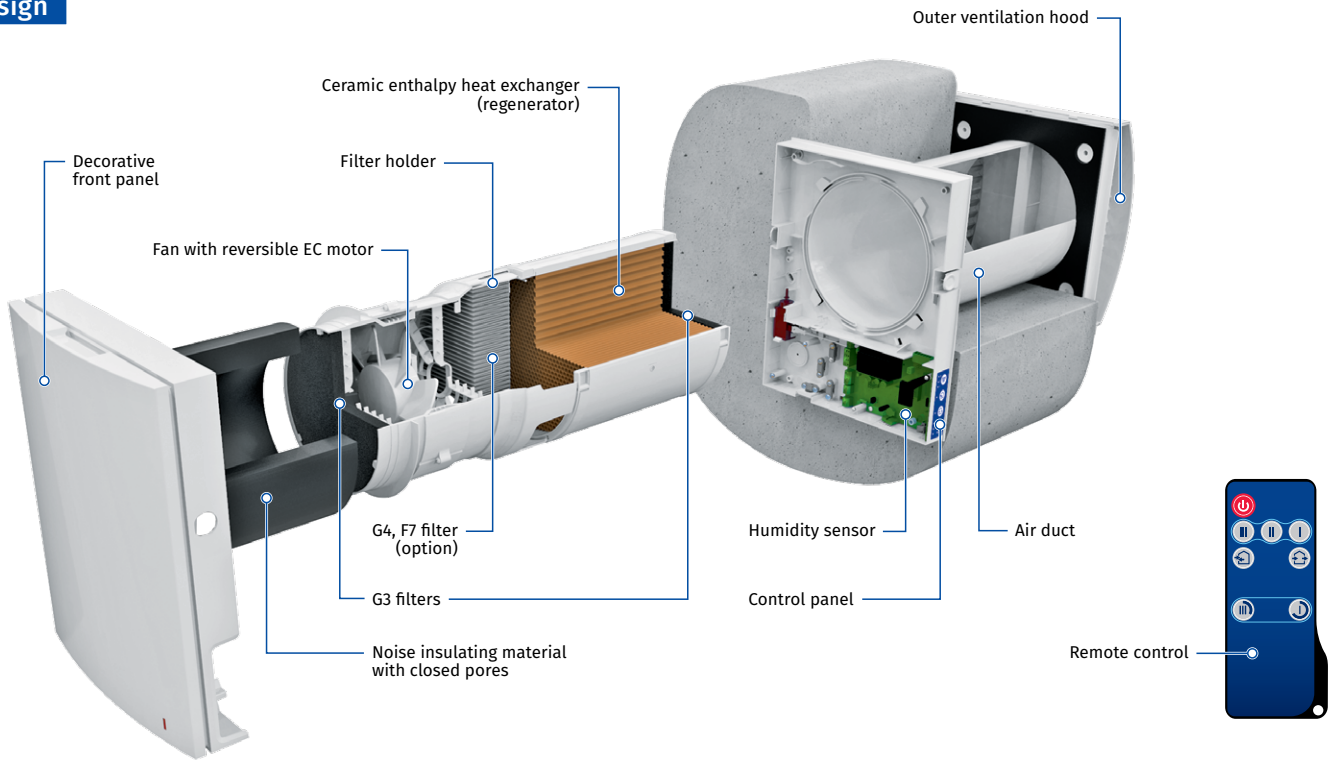

Easy maintenance. Indoor unit is opened by pressing the latches on both sides

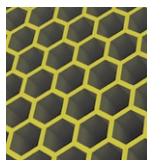

One of the best regeneration efficiency on the market due to innovative hexagonal structure of the heat exchanger cells



Integrated automatic air shutters prevent air back drafting



The specially designed front panel can be closed manually to ensure 100 % air tightness and protect against wind impact

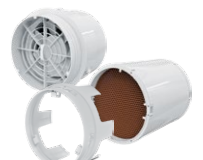

The demountable design of the regenerator cartridge improves heat recovery efficiency and simplifies maintenance

Designation key

Model	Air duct	Rated air flow [m ³ /h]	Front panel	Ventilation hood type	Control
Vento Expert	A: round air duct	50	-1: flat front panel	-: white plastic hood AH-10 white 160 (for standard walls) S: metal hood for thin walls	Pro V.3: control with touch buttons and a remote control

VENTO EXPERT A50-1 PRO V.3

HEAT RECOVERY SINGLE-ROOM UNITS

Heat and humidity regeneration

UNIT OPERATING LOGIC IN WINTER PERIOD

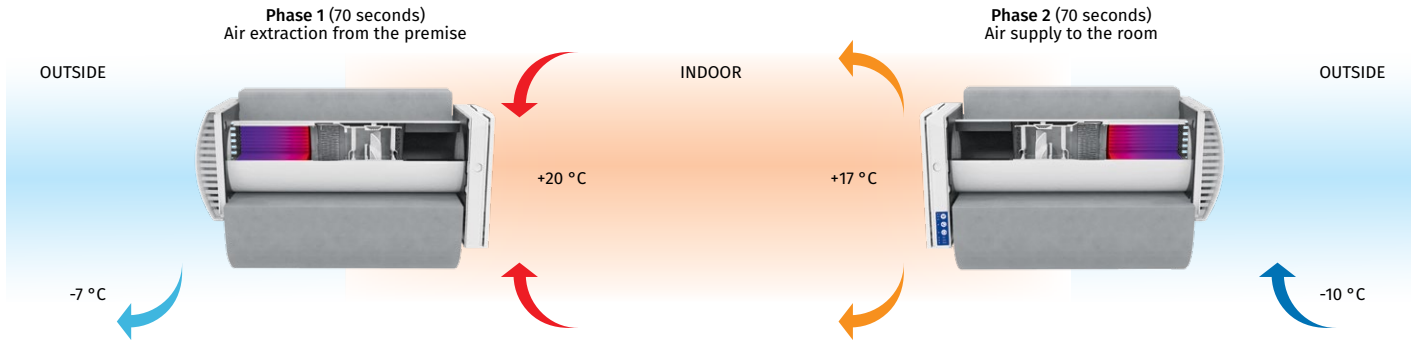

- Warm stale air is extracted from the premise, flows through the ceramic regenerator and transfers its heat energy and moisture to it.
- As the ceramic regenerator gets warmed up, the unit switches to the supply mode.

- Clean cold intake air flows through the regenerator and absorbs accumulated heat and humidity.
- When the ceramic regenerator is cooled down, the unit switches to the extract air mode.

Control

- Control of the unit operation mode is performed by means of sensor control panel located on the unit casing or a remote controller.

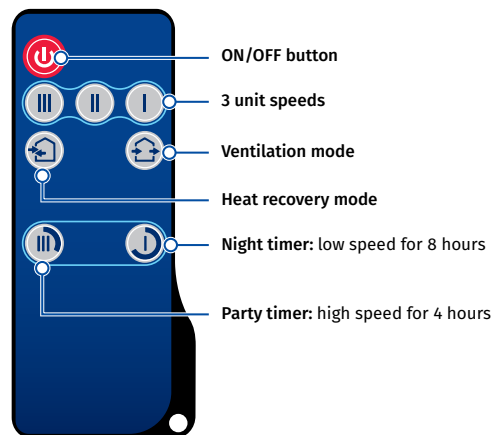
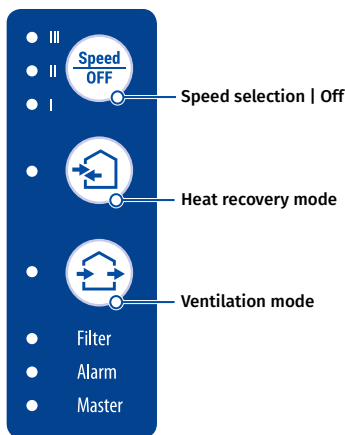

Vento Expert is equipped with a humidity sensor for indoor humidity control. If humidity increases above a set point, the unit boosts to the speed III.

Vento Expert either can operate as independent unit or can be connected with other units in a house and controlled with a master unit. In this case, only the master unit receives a signal from the remote control.

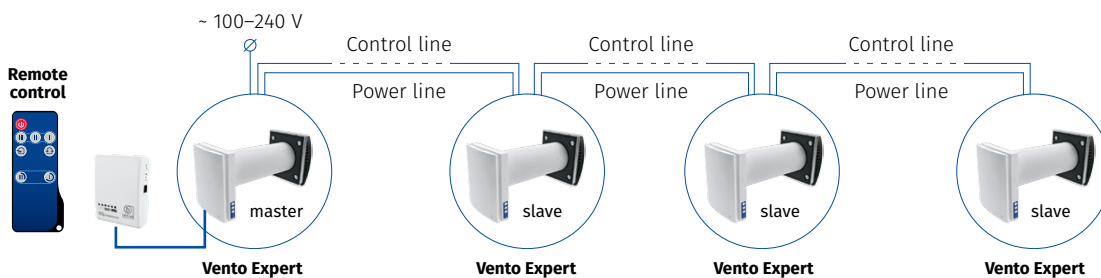

VENTO EXPERT A50-1 PRO V.3

HEAT RECOVERY SINGLE-ROOM UNITS

Mounting

- The unit is designed for through-the-wall installation inside a prepared hole in an outer wall of the building.
- The best ventilation solution is pairwise installation of reverse phase connected units. Some units ensure supply of fresh air to the room and the other units extract air from the premise. This way the most efficient balanced ventilation is arranged.
- In case of brand new construction, units are mounted in two stages:
 - **Pre-installation** at the stage of the indoor finishing and outer decorative wall finishing. It includes installation of an air duct, an outer ventilation hood and cable installation.
 - **Final mounting** before commissioning of a house. It includes installation of a regenerator with a fan and filters and mounting and wiring of an indoor unit with a controller and shutters.

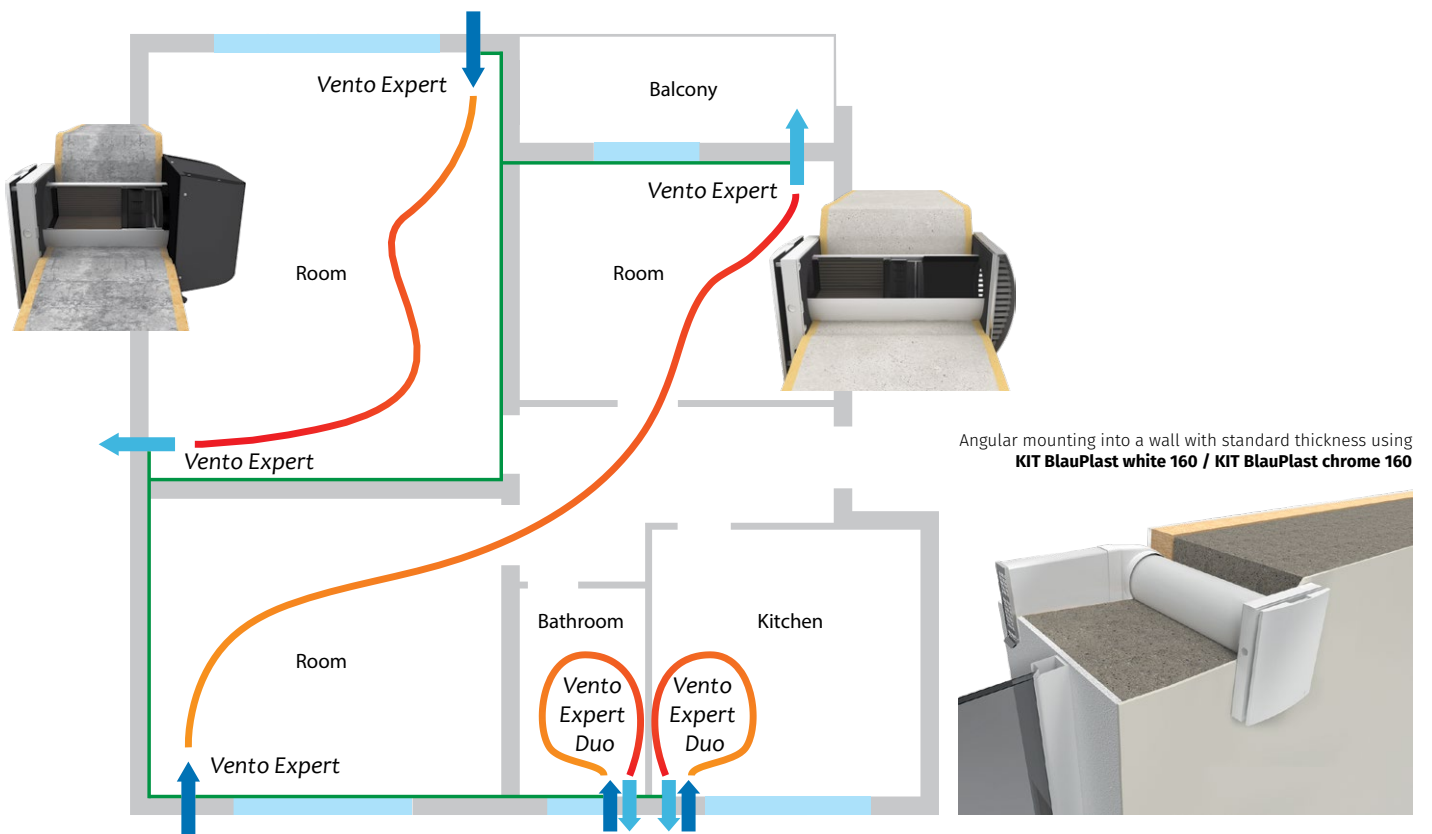

VENTO EXPERT A50-1 PRO V.3

HEAT RECOVERY SINGLE-ROOM UNITS

Technical data

Parameters	Vento Expert A50-1 Pro V.3		
	I	II	III
Speed			
Voltage [V / 50 (60) Hz]		100-240	
Power [W]	5.0	6.0	8.5
Current [A]	0.035	0.040	0.059
RPM [min ⁻¹]	800	1300	1900
Air flow in ventilation mode [m ³ /h (l/s)]	15 (4)	35 (10)	50 (14)
Air flow in heat recovery mode [m ³ /h (l/s)]	8 (2)	18 (5)	25 (7)
SFP [W/l/s]	2.40	1.44	1.22
Filter	G3 (Option: G4; F7 PM2.5 > 70 %*)		
Transported air temperature [°C]	-20...+40		
Sound pressure level at 1 m [dBA]	13	25	37
Sound pressure level at 3 m [dBA]	4	16	28
Outdoor sound pressure attenuation [dBA] in accordance with DIN EN 20140	41/47**		
Indoor/outdoor airtightness classification of the complete unit in accordance with EN 13141-8	D1		
Heat recovery efficiency according to DIBt LÜ-A 20 [%]	up to 95		
Ingress Protection Rating	IP24		

* maximum air flow 40 m³/h

** with open and closed front panel

ENERGIA - ЕНЕРГИЯ - ΕΝΕΡΓΕΙΑ - ENERGIA - ENERGY - ENERGI

2020 1254/2014

Overall dimensions [mm]

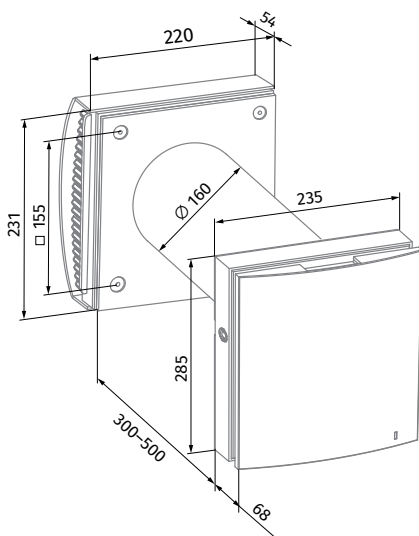

Vento Expert A50-1 Pro V.3

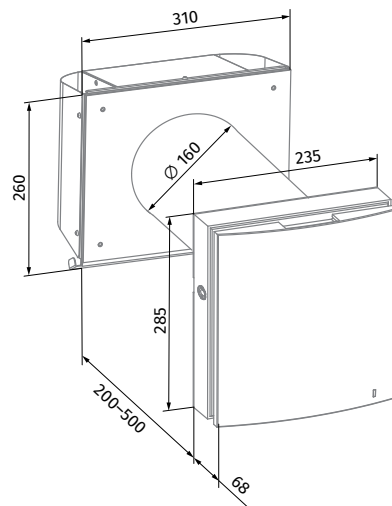













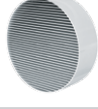

Vento Expert A50-1 S Pro V.3
(for thin walls)

VENTO EXPERT A50-1 PRO V.3









HEAT RECOVERY SINGLE-ROOM UNITS

Accessories

Name		Description
Pre-installation Kit Vento Expert A50-1		Pre-installation kit for mounting into a wall with standard thickness. Includes: • Air duct • AH 160 outer ventilation hood • Plastic foam plug • Plastic foam wedges
Pre-installation Kit Vento Expert A50-1 S		Pre-installation kit for mounting into a thin wall. Includes: • Air duct • AH-S chrome 160 outer ventilation hood • Plastic foam plug • Plastic foam wedges
Completion Kit Vento Expert A50-1 Pro V.3		Final mounting kit. Includes: • Regenerator module • Fan module • G3 filters (2 pcs.) • Indoor unit with a controller and shutters • Remote control
FP2 Vento G3		G3 filters (2 pcs.)
FP2 Vento G4		Coarse filter. Includes: • Plastic filter holder (1 pc.) • G4 filter (1 pc.).
FPC 150x50 G4		G4 coarse filter
FP2 Vento F7		Filter set. Includes: • Plastic filter holder (1 pc.) • F7 fine filter (1 pc.). Filtration rate PM2.5 > 70 %
FPC 150x50 F7		F7 fine filter. Filtration rate PM2.5 > 70 %
AH-8 white 160		White painted aluminium outer ventilation hood with frost protection for a cold climate
AH-8 chrome 160		Brushed stainless steel outer ventilation hood with frost protection for a cold climate
AH-10 *colour* 160		Plastic outer ventilation hood. Available in colours: 
AH-10 chrome 160		Plastic outer ventilation hood with a plate with brushed stainless steel effect finish
AH-11 *colour* 160		Plastic outer ventilation hood. Available in colours: 

VENTO EXPERT A50-1 PRO V.3

HEAT RECOVERY SINGLE-ROOM UNITS

Name		Description
AH-S chrome 160		Outer ventilation hood for thin wall made of brushed stainless steel
AH-S grey 160		Outer ventilation hood for thin wall, painted grey
PP 160/0.5		Outer ventilation hood for mounting from inside
KIT BlauPlast white 160		Kit for angular mounting with white colour grille (for walls with standard thickness)
KIT BlauPlast chrome 160		Kit for angular mounting with stainless steel outer grille (for walls with standard thickness)
FB-Vento Expert		Remote control
CD-1		CO ₂ sensor with LED CO ₂ indication and a sensor button for operation mode selection
CD-2		CO ₂ sensor

VENTO EXPERT DUO A30-1 S10 PRO

HEAT RECOVERY SINGLE-ROOM UNITS

Features

- Arrangement of efficient energy-saving supply and exhaust single-room ventilation in flats, houses, cottages, social and commercial premises.
- Reducing heat losses caused by ventilation due to heat recovery.
- Humidity balance and regulated air exchange create individually controlled microclimate.
- Coordinated network based on several integrated single-room ventilation units with central control.



Air flow:
up to 30 m³/h
8 l/s



Heat recovery efficiency:
up to 85 %



Power: from 2.00 W
SFP: from 0.67 W/l/s



Noise level:
from 24 dBA



Dear partners! Please note that as of the end of the third quarter of 2020, in order to increase the efficiency of the Vento Expert Duo, the company manufactures products with regenerators divided into two sections.



Design

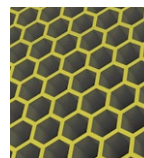
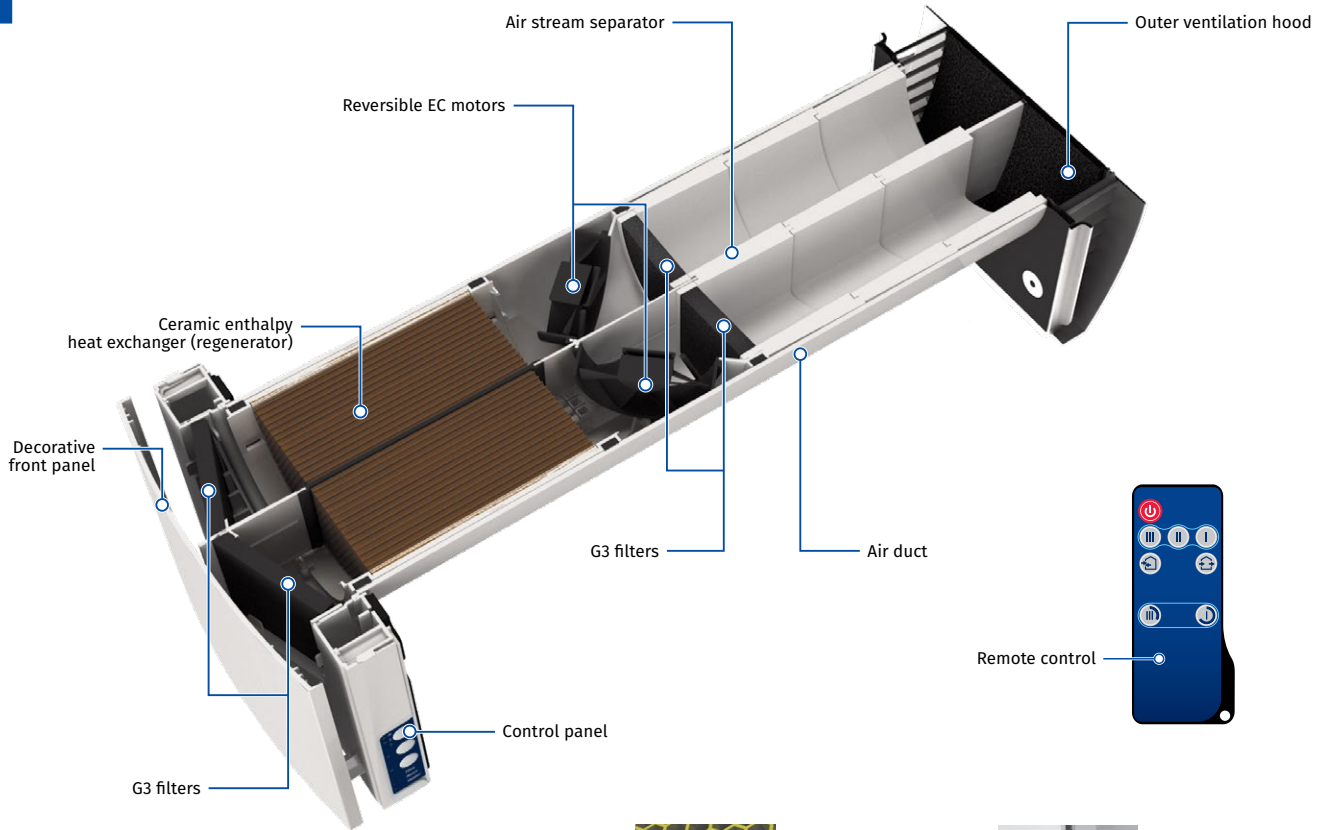

One of the best regeneration efficiency on the market due to innovative hexagonal structure of the heat exchanger cells



Easy maintenance. Indoor unit is opened by pressing the latches on both sides

Designation key

Model	Fans	Air duct	Rated air flow [m ³ /h]	Front panel	Ventilation hood type	Control
Vento Expert	Duo: two fans with different rotation direction	A: round air duct	30	-1: flat front panel	S10: white plastic hood AH-10 white 160 Duo	Pro: control with touch buttons and a remote control

VENTO EXPERT DUO A30-1 S10 PRO

HEAT RECOVERY SINGLE-ROOM UNITS

Heat and humidity regeneration

UNIT OPERATING LOGIC IN WINTER PERIOD

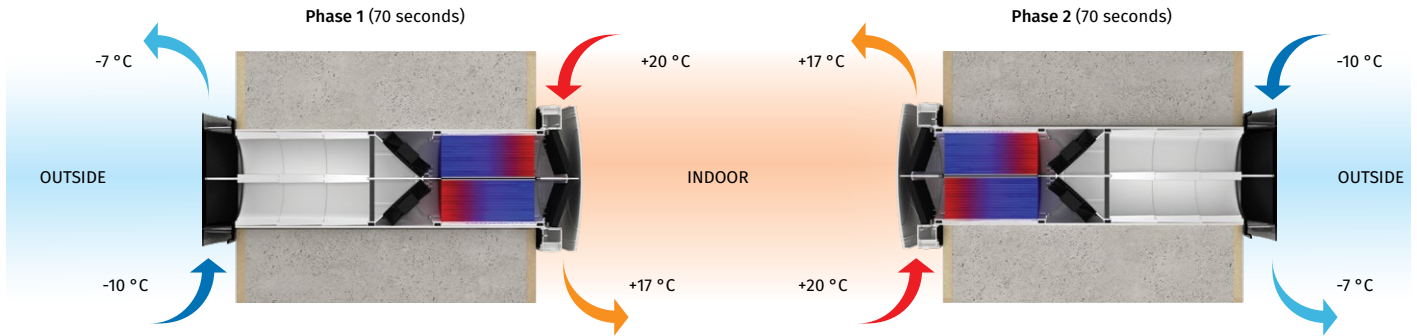

- To increase the efficiency of the Vento Expert Duo, the regenerator is divided into two parts, which are isolated from one another, thus eliminating the transfer of heat and moisture between them.
- One of the fans operates in the supply mode: fresh cold intake air from outside flows through the first regenerator, and absorbs accumulated heat and humidity.

- At the same time, the other fan operates in the exhaust mode: warm stale air is extracted from the room to the outside, and while passing through the other regenerator, gradually heats it up and transfers some of the moisture.
- After 70 seconds operation the fans change the rotation direction and opposite processes start.

Control

- Control of the unit operation mode is performed by means of the sensor control panel located on the unit casing or the remote controller.

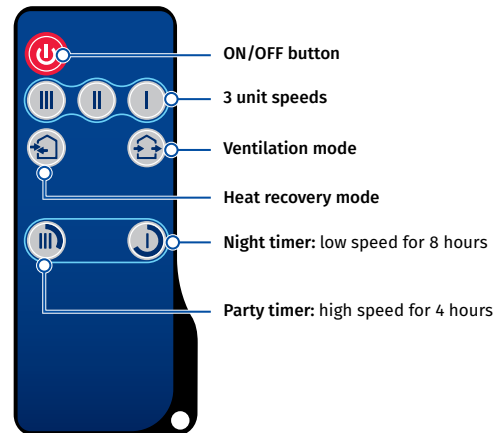
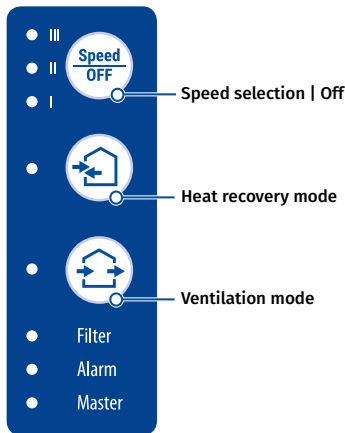

Vento Expert Duo either can operate as independent unit or can be wired with other units in a house and controlled with a master unit. In this case, only the master unit receives a signal from the remote control.

Vento Expert Duo is equipped with a humidity sensor for indoor humidity control. If humidity increases above a set point, the unit boosts to the speed III.

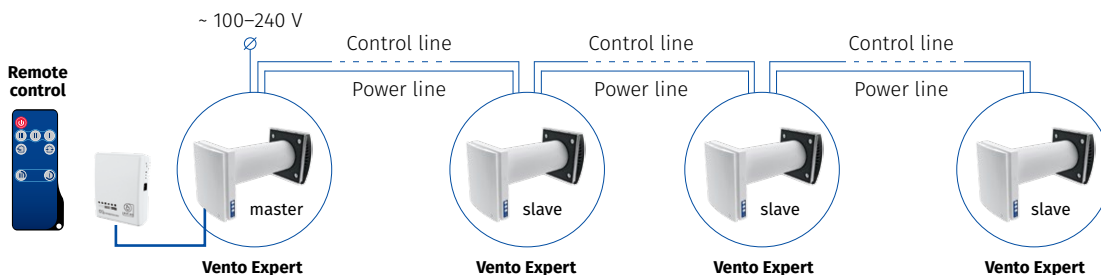

VENTO EXPERT DUO A30-1 S10 PRO

HEAT RECOVERY SINGLE-ROOM UNITS

Mounting

- **Vento Expert Duo** must be installed in each room with high humidity like kitchen, bathroom to be ventilated while Vento Expert must be installed in each living room to be ventilated.
- The unit is designed for through-the-wall installation inside a prepared core hole in an outer wall of the building.

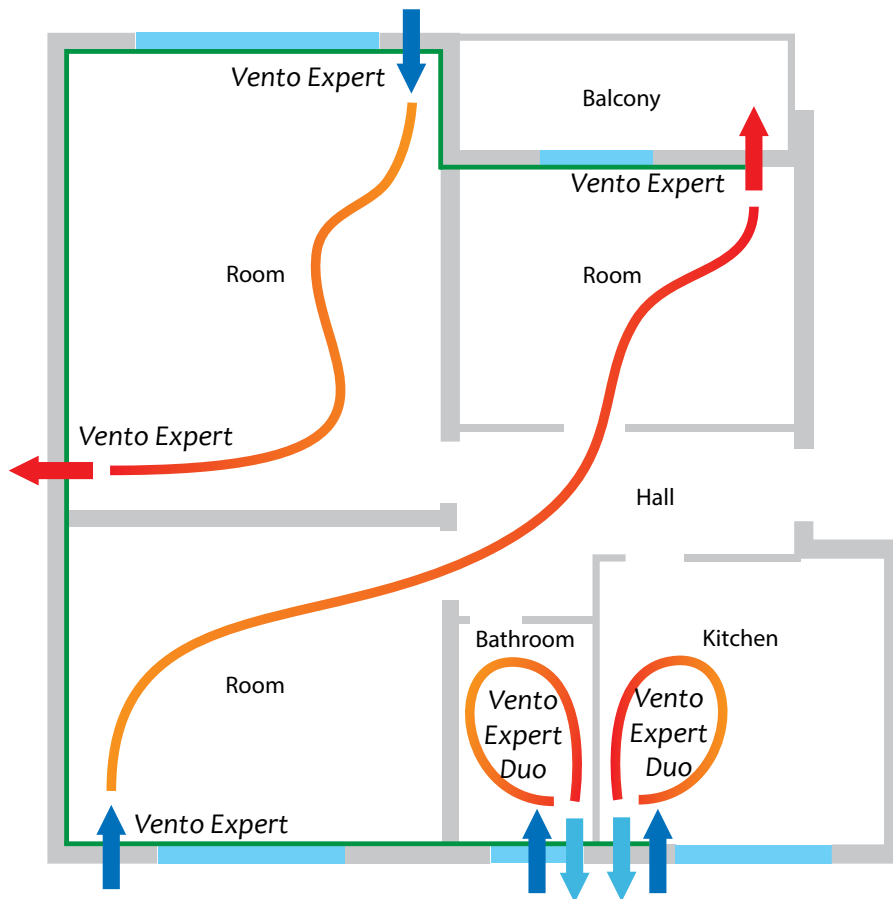

VENTO EXPERT DUO A30-1 S10 PRO

HEAT RECOVERY SINGLE-ROOM UNITS

Technical data

Parameters	Vento Expert Duo A30-1 S10 Pro		
	I	II	III
Speed			
Voltage [V / 50 (60) Hz]		100-240	
Power [W]	2.00	3.70	6.40
Current [A]	0.027	0.043	0.067
RPM [min ⁻¹]	1600	2200	2500
Air flow [m ³ /h (l/s)]	10 (3)	20 (6)	30 (8)
Air flow in humidity extract mode [m ³ /h (l/s)]		60 (16)	
SFP [W/l/s]	0.72	0.67	0.77
Filter		G3	
Transported air temperature [°C]		-15...+40	
Sound pressure level at 1 m [dBA]	33	40	43
Sound pressure level at 3 m [dBA]	24	31	34
Outdoor sound pressure attenuation [dBA] in accordance with DIN EN 20140		42	
Indoor/outdoor airtightness classification of the complete unit in accordance with EN 13141-8		D2	
Heat recovery efficiency according to DIBt LÜ-A 20 [%]		up to 85	
Ingress protection rating		IP24	

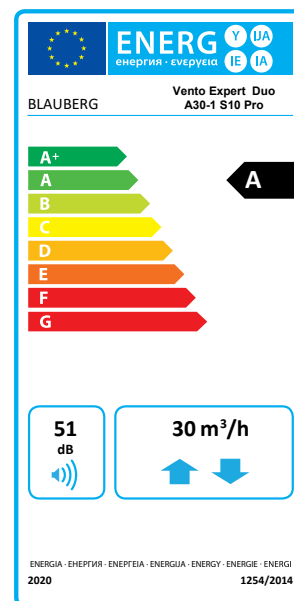

Overall dimensions [mm]

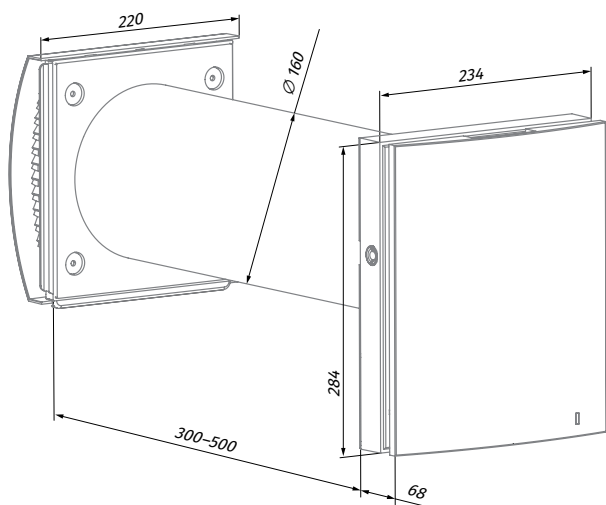









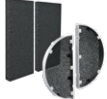









Vento Expert Duo A30-1 S10 Pro

VENTO EXPERT DUO A30-1 S10 PRO

HEAT RECOVERY SINGLE-ROOM UNITS

Accessories

Name	Description
FP Vento Expert Duo A30 G3	 <p>G3 filter set. Includes: • Rectangular filter G3 (2 pcs.) • Semicircular filter G3 (2 pcs.)</p>
FP1 Vento Expert Duo A30 G3	 <p>G3 filter set. Includes: • Rectangular filter G3 (2 pcs.) • Semicircular filter G3 (2 pcs.) • Plastic filter holder (2 pcs.)</p>
AH-10 *colour* 160 Duo	 <p>Plastic outer ventilation hood. Available in colours:</p> <div style="display: flex; justify-content: space-around; align-items: center;"> <div style="text-align: center;"> white</div> <div style="text-align: center;"> black</div> <div style="text-align: center;"> grey</div> <div style="text-align: center;"> terracotta</div> <div style="text-align: center;"> brown</div> <div style="text-align: center;"> vintage</div> </div>
AH-10 chrome 160 Duo	 <p>Plastic outer ventilation hood with a plate with brushed stainless steel effect finish</p>
AH-5 white 160 Duo	 <p>Stainless steel outer ventilation hood, painted white</p>
AH-5 chrome 160 Duo	 <p>Outer ventilation hood made of brushed stainless steel</p>
PP 160/0.5	 <p>Outer ventilation hood for mounting from inside</p>
LST Vento Expert Duo	 <p>Air stream separator</p>
R 160-500	 <p>500 mm air duct and plastic foam plug</p>
R 160-700	 <p>700 mm air duct and plastic foam plug</p>
FB Vento Expert A50	 <p>Remote control</p>
CD-1	 <p>CO₂ sensor with LED CO₂ indication and a sensor button for operation mode selection</p>
CD-2	 <p>CO₂ sensor</p>

VENTO ECO A50-4 S11 PRO

HEAT RECOVERY SINGLE-ROOM UNITS

Features

- Arrangement of efficient energy-saving supply and exhaust single-room ventilation in flats, houses, cottages, social and commercial premises.
- Air purification with optional F8 filter PM2.5 > 99 %.
- Protection from outdoor noise.
- Reducing heat losses caused by ventilation due to heat recovery.
- Humidity balance and regulated air exchange create individually controlled microclimate.



Air flow:
up to 50 m³/h
14 l/s



Heat recovery efficiency:
up to 92 %



Power: from 1.00 W
SFP: from 0.48 W/l/s



Noise level:
from 12 dBA



Design

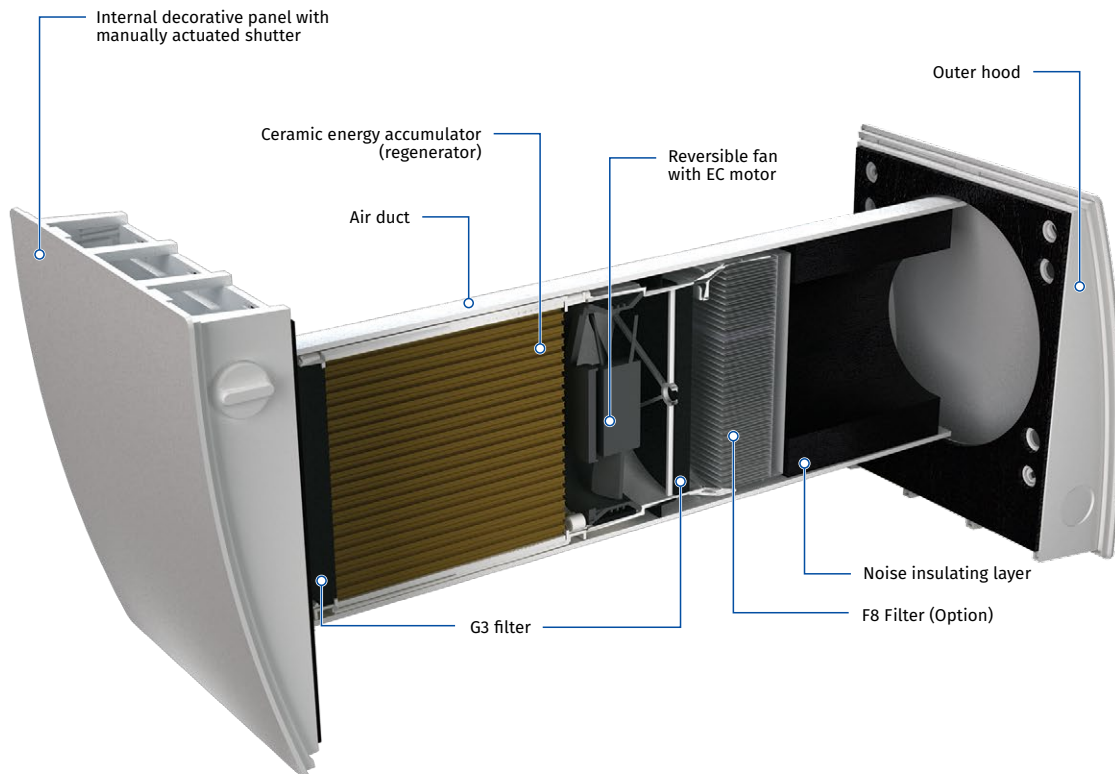

Designation key

Model	Air duct	Rated air flow [m ³ /h]	Internal grille type	Ventilation hood type	Control
Vento Eco	A: round air duct	50	-4	S11: plastic hood for standard walls S: metal hood for thin walls	Pro: sensor control panel

VENTO ECO A50-4 S11 PRO

HEAT RECOVERY SINGLE-ROOM UNITS

Heat and humidity regeneration

UNIT OPERATING LOGIC IN WINTER PERIOD

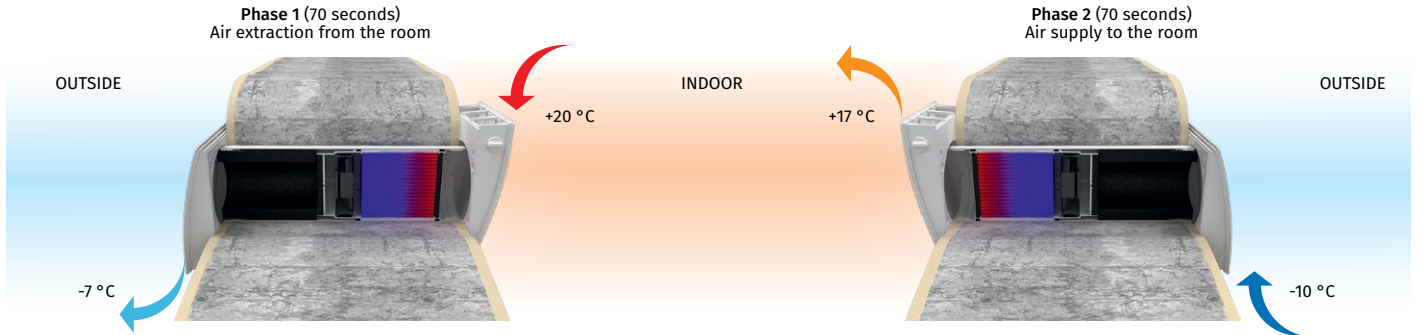

- Warm stale air is extracted from the premise, flows through the ceramic regenerator and transfers its heat energy and moisture to it.
- As the ceramic regenerator gets warmed up, the unit switches to the supply mode.
- Clean cold intake air flows through the regenerator and absorbs accumulated heat and humidity.
- When the ceramic regenerator is cooled down, the unit switches to the extract air mode.

Control

- Control of the unit operation mode is performed by means of the sensor control panel.

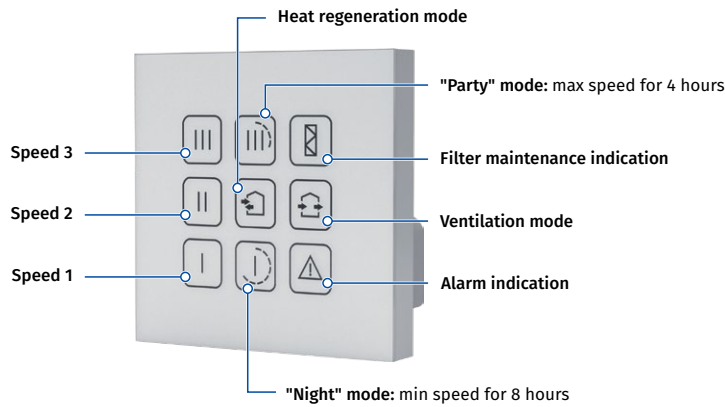

- One control panel with sensor buttons can control up to two units.
- Low voltage (12 V) power supply between control panel and **Vento Eco** units.

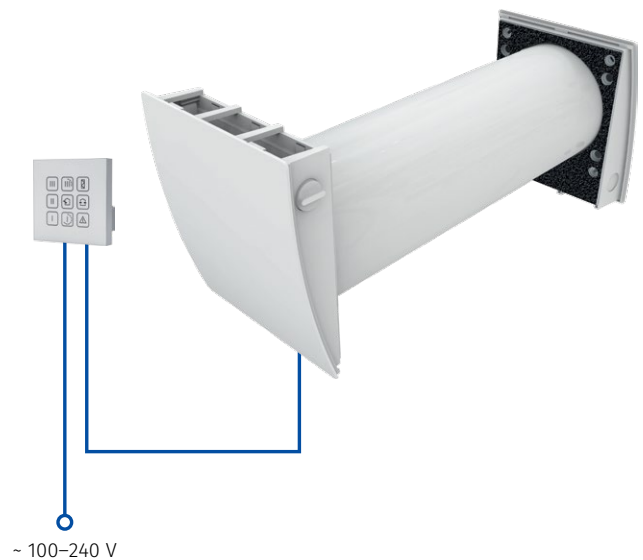

VENTO ECO A50-4 S11 PRO

HEAT RECOVERY SINGLE-ROOM UNITS

Mounting

- The unit is designed for through-the-wall installation inside a prepared hole in an outer wall of the building.
- One unit is able to ventilate a room up to 25 m². For bigger rooms two or more units must be installed.

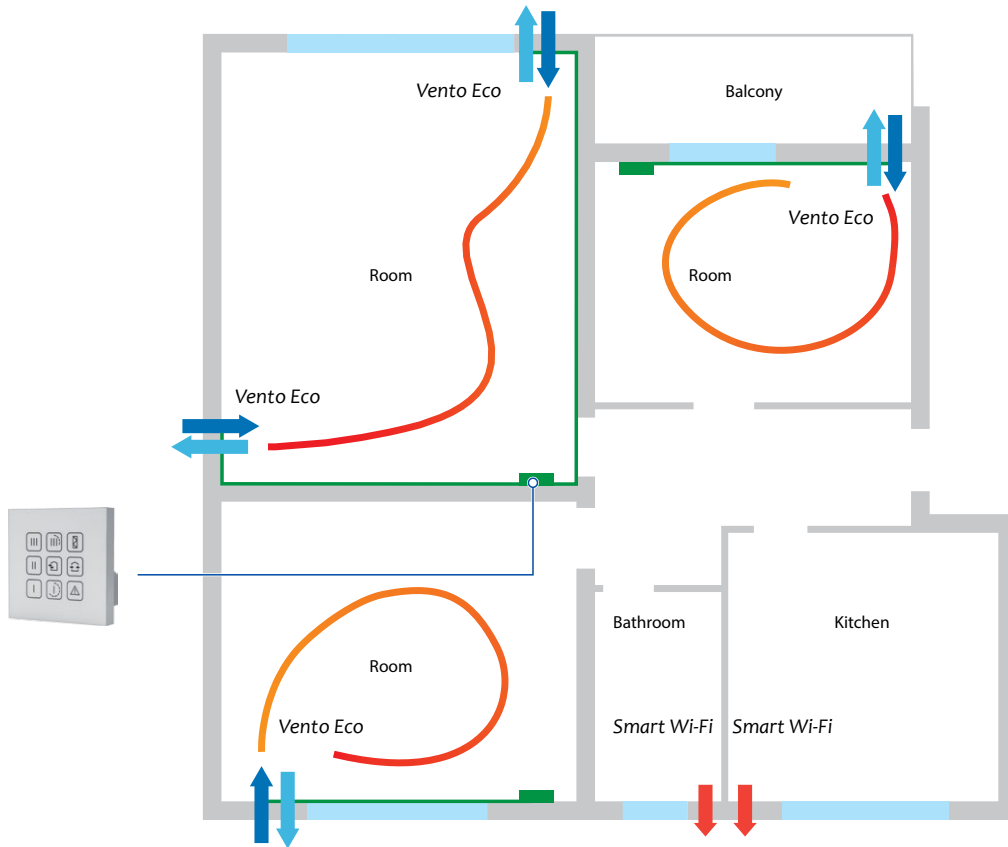

VENTO ECO A50-4 S11 PRO

HEAT RECOVERY SINGLE-ROOM UNITS

Technical data

Parameters	Vento Eco A50-4 S11 Pro Vento Eco A50-4 S Pro		
	I	II	III
Speed			
Voltage [V / 50 (60) Hz]	100-240		
Power [W]	1.00	2.10	4.30
Current [A]	0.017	0.025	0.041
RPM [min ⁻¹]	915	1555	2330
Air flow in ventilation mode [m ³ /h (l/s)]	15 (4)	30 (8)	50 (14)
Air flow in heat recovery mode [m ³ /h (l/s)]	8 (2)	15 (4)	25 (7)
SFP [W/l/s]	0.48	0.50	0.62
Filter	G3 (Option: F8 PM2.5 > 99%*)		
Transported air temperature [°C]	-20(-30**)...+40		
Heat recovery efficiency according to DIBt LÜ-A 20 [%]	up to 92		
Outdoor sound pressure attenuation according to DIN EN 20140 [dBA]	41		
Classification of air flow sensitivity to pressure difference variations in accordance with EN 13141-8	S3***		
Indoor/outdoor airtightness classification of the complete unit in accordance with EN 13141-8	D1		
Sound pressure level at 1 m according to ISO 3741: 2004 [dBA]	21	27	29
Sound pressure level at 3 m according to ISO 3741: 2004 [dBA]	12	18	20
Ingress protection rating	IP24		

* maximum air flow 40 m³/h

** with ZL1 Vento 160/100 cartridge and AH-8 outer hood applied

*** at III speed

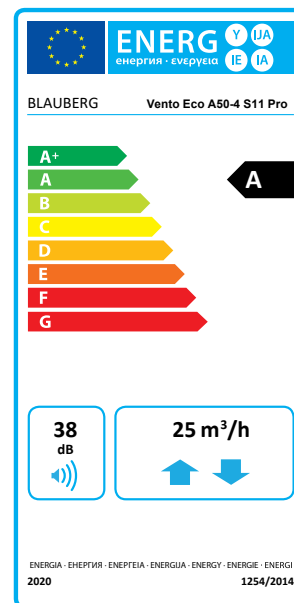

Overall dimensions [mm]

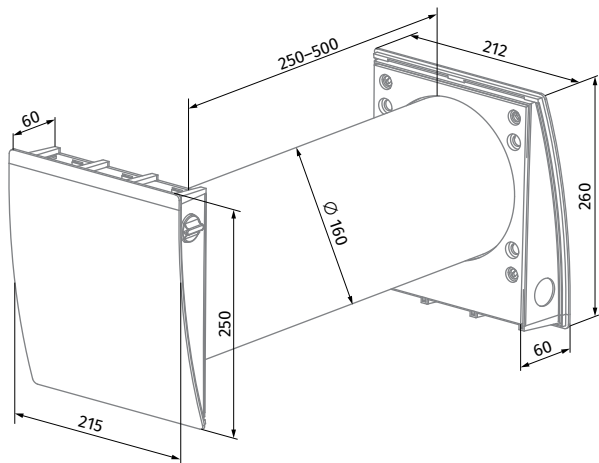

Vento Eco A50-4 S11 Pro

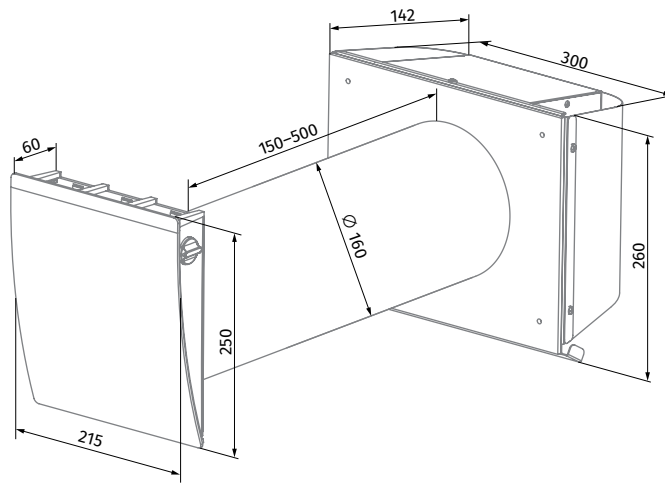









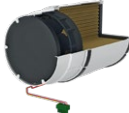















Vento Eco A50-4 S Pro
(for thin walls)

VENTO ECO A50-4 S11 PRO





HEAT RECOVERY SINGLE-ROOM UNITS

Accessories

Name		Description
Completion Kit Vento Eco A50-4		Indoor grille and cartridge with heat regenerator, fan and G3 filters
ZL1 Vento 160/150		Cartridge with heat regenerator for cold climate
FP2 Vento G3		G3 filters (2 pcs.)
FP2 Vento F8		G2 + F8 filters (1 pc.). Filtration rate PM2.5 > 99 %. Combination of G2 + F8 filters reduces air flow down to 40 m³/h
AH-8 white 160		White painted aluminium outer ventilation hood with frost protection for a cold climate
AH-8 chrome 160		Brushed stainless steel outer ventilation hood with frost protection for a cold climate
AH-10 *colour* 160		Plastic outer ventilation hood. Available in colours:  white  black  grey  terracotta  brown  vintage
AH-10 chrome 160		Plastic outer ventilation hood with a plate with brushed stainless steel effect finish
AH-11 *colour* 160		Plastic outer ventilation hood. Available in colours:  white  black  grey  terracotta  brown  vintage
AH-S chrome 160		Outer ventilation hood for thin wall made of brushed stainless steel
AH-S white 160		Outer ventilation hood for thin wall made of stainless steel, painted white
PP 160/0,5		Outer ventilation hood for mounting from inside
KIT BlauPlast white 160		Kit for angular mounting with white colour grille (for walls with standard thickness)

VENTO ECO A50-4 S11 PRO

HEAT RECOVERY SINGLE-ROOM UNITS

Name		Description
KIT BlauPlast chrome 160		Kit for angular mounting with stainless steel outer grille (for walls with standard thickness)
R 160-500		500 mm air duct and plastic foam plug
R 160-700		700 mm air duct and plastic foam plug
SE Vento Eco A50 Pro		Sensor control panel

VENTO ECO2 A50-4 S11 PRO

HEAT RECOVERY SINGLE-ROOM UNITS

Features

- Two units operating in opposite phases ensure balanced ventilation.
- Arrangement of efficient energy-saving supply and exhaust single-room ventilation in flats, houses, cottages, social and commercial premises.
- Air purification with optional F8 filter PM2.5 > 99 %.
- Protection from outdoor noise.
- Reducing heat losses caused by ventilation due to heat recovery.
- Humidity balance and regulated air exchange create individually controlled microclimate.



Air flow:
up to 50 m³/h
14 l/s



Heat recovery efficiency:
up to 92 %



Power: from 2.37 W
SFP: from 0.46 W/l/s



Noise level:
from 12 dBA



Design

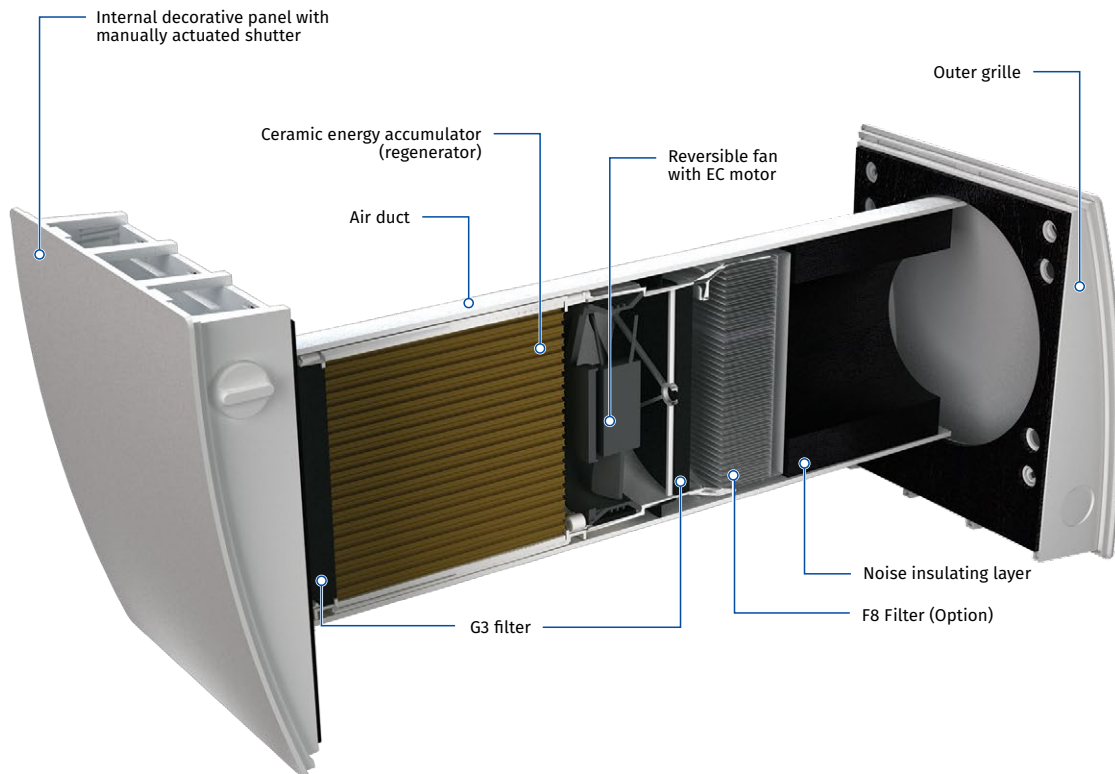

Designation key

Model	Air duct	Rated air flow [m ³ /h]	Internal grille type	Ventilation hood type	Control
Vento Eco2	A: round air duct	50	-4	S11: plastic hood for standard walls S: metal hood for thin walls	Pro: sensor control panel

VENTO ECO2 A50-4 S11 PRO

HEAT RECOVERY SINGLE-ROOM UNITS

Heat and humidity regeneration

UNIT OPERATING LOGIC IN WINTER PERIOD

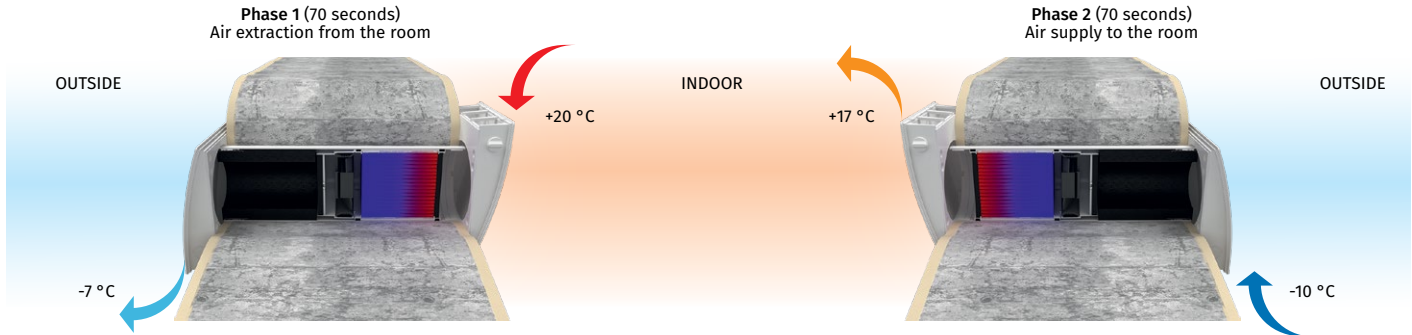

- Warm stale air is extracted from the premise, flows through the ceramic regenerator and transfers its heat energy and moisture to it.
- As the ceramic regenerator gets warmed up, the unit switches to the supply mode.
- Clean cold intake air flows through the regenerator and absorbs accumulated heat and humidity.
- When the ceramic regenerator is cooled down, the unit switches to the extract air mode.

Control

- Control of the unit operation mode is performed by means of the sensor control panel.

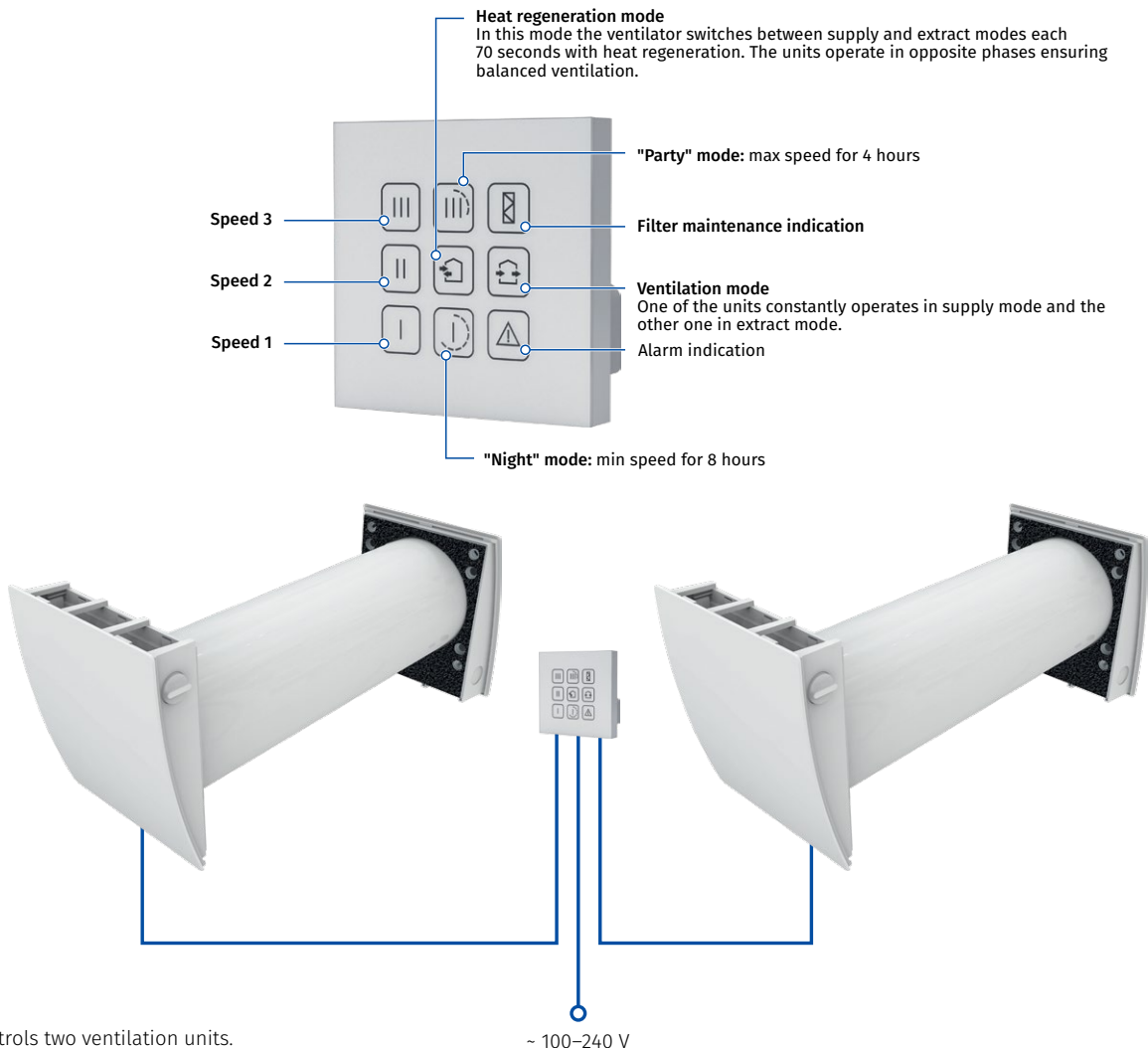

- One LCD panel controls two ventilation units.
- Low voltage (12 V) power supply between control panel and **Vento Eco** units.

VENTO ECO2 A50-4 S11 PRO

HEAT RECOVERY SINGLE-ROOM UNITS

Mounting

- The unit is designed for through-the-wall installation inside a prepared hole in an outer wall of the building.
- One unit is able to ventilate a room up to 25 m². For larger rooms, two or more units are required.

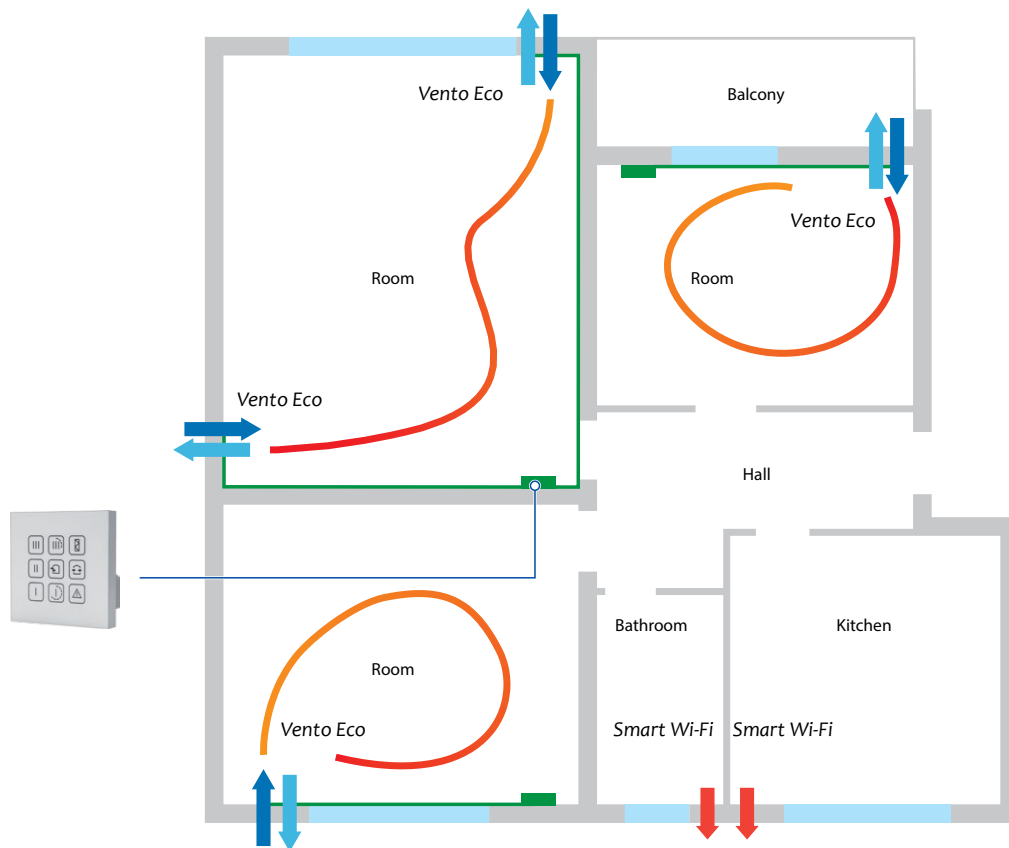

VENTO ECO2 A50-4 S11 PRO

HEAT RECOVERY SINGLE-ROOM UNITS

Technical data

Parameters	Vento Eco2 A50-4 S11 Pro		
	Vento Eco2 A50-4 S Pro		
Speed	I	II	III
Voltage [V / 50 (60) Hz]	100-240		
Power [W]	2.37	3.80	7.61
Current [A]	0.033	0.047	0.080
RPM [min ⁻¹]	915	1555	2330
Air flow in ventilation mode [m ³ /h (l/s)]	15 (4)	30 (8)	50 (14)
Air flow in recovery mode [m ³ /h (l/s)]	15 (4)	30 (8)	50 (14)
SFP [W/l/s]	0.57	0.46	0.55
Filter	G3 (Option: F8 PM2.5 > 99 %*)		
Transported air temperature [°C]	-20(-30**)...+40		
Outdoor sound pressure attenuation according to DIN EN 20140 [dBA]	41		
Heat recovery efficiency according to DIBt LÜ-A 20 [%]	up to 92		
Sound pressure level at 1 m according to ISO 3741: 2004 [dBA]	21	27	29
Sound pressure level at 3 m according to ISO 3741: 2004 [dBA]	12	18	20
Classification of air flow sensitivity to pressure difference variations in accordance with EN 13141-8	S3***		
Indoor/outdoor airtightness classification of the complete unit in accordance with EN 13141-8	D1		
Ingress protection rating	IP24		

* maximum air flow 40 m³/h

** with ZL1 Vento 160/150 cartridge and AH-8 outer hood applied

*** at III speed

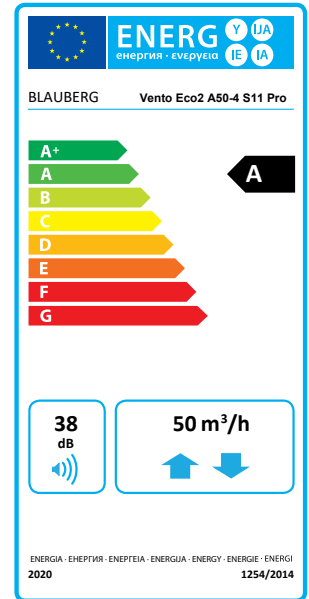

Overall dimensions [mm]

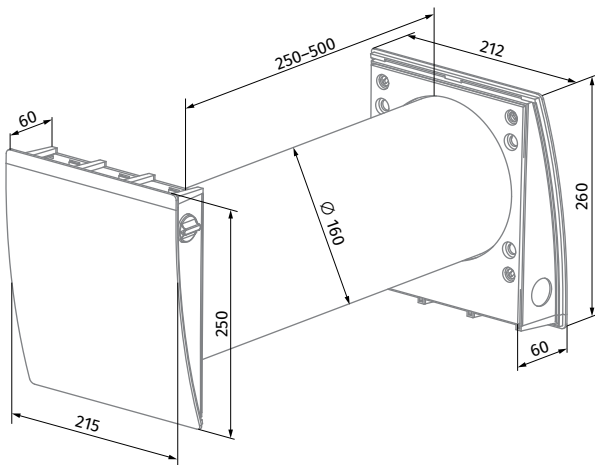

Vento Eco2 A50-4 S11 Pro

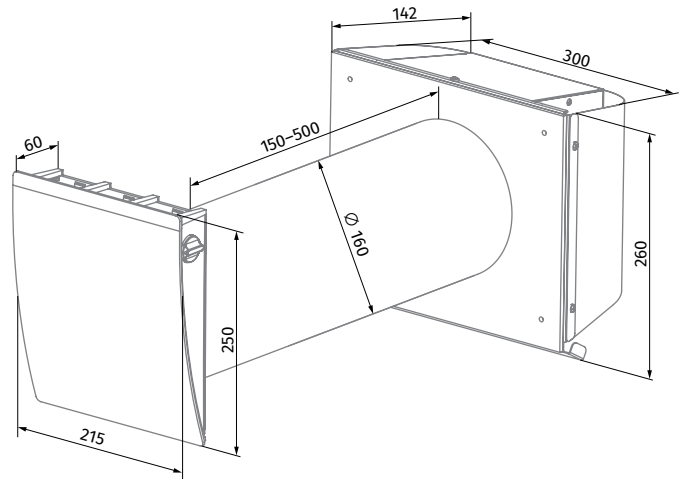









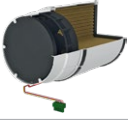















Vento Eco2 A50-4 S Pro
(for thin walls)

VENTO ECO2 A50-4 S11 PRO





HEAT RECOVERY SINGLE-ROOM UNITS

Accessories

Name		Description
Completion Kit Vento Eco A50-4		Indoor grille and cartridge with heat regenerator, fan and G3 filters
ZL1 Vento 160/150		Cartridge with heat regenerator for cold climate
FP2 Vento G3		G3 filters (2 pcs.)
FP2 Vento F8		G2 + F8 filters (1 pc.). Filtration rate PM2.5 > 99 %. Combination of G2 + F8 filters reduces air flow down to 40 m³/h
AH-8 white 160		White painted aluminium outer ventilation hood with frost protection for a cold climate
AH-8 chrome 160		Brushed stainless steel outer ventilation hood with frost protection for a cold climate
AH-10 *colour* 160		Plastic outer ventilation hood. Available in colours:  white  black  grey  terracotta  brown  vintage
AH-10 chrome 160		Plastic outer ventilation hood with a plate with brushed stainless steel effect finish
AH-11 *colour* 160		Plastic outer ventilation hood. Available in colours:  white  black  grey  terracotta  brown  vintage
AH-S chrome 160		Outer ventilation hood for thin wall made of brushed stainless steel
AH-S grey 160		Outer ventilation hood for thin wall, painted grey
PP 160/0.5		Outer ventilation hood for mounting from inside
KIT BlauPlast white 160		Kit for angular mounting with white colour grille (for walls with standard thickness)

VENTO ECO2 A50-4 S11 PRO

HEAT RECOVERY SINGLE-ROOM UNITS

Name		Description
KIT BlauPlast chrome 160		Kit for angular mounting with stainless steel outer grille (for walls with standard thickness)
R 160-500		500 mm air duct and plastic foam plug
R 160-700		700 mm air duct and plastic foam plug
SE Vento Eco A50 Pro		Sensor control panel

VENTO ECO A30-4 S11 PRO

HEAT RECOVERY SINGLE-ROOM UNITS

Features

- o Arrangement of efficient energy-saving supply and exhaust single-room ventilation in flats, houses, cottages, social and commercial premises.
- o Protection from outdoor noise.
- o Reducing heat losses caused by ventilation due to heat recovery.
- o Humidity balance and regulated air exchange create individually controlled microclimate.



Air flow:
up to 30 m³/h
8 l/s



Heat recovery efficiency:
up to 81 %



Power: from 1.03 W
SFP: from 0.71 W/l/s



Noise level:
from 21 dBA



Design

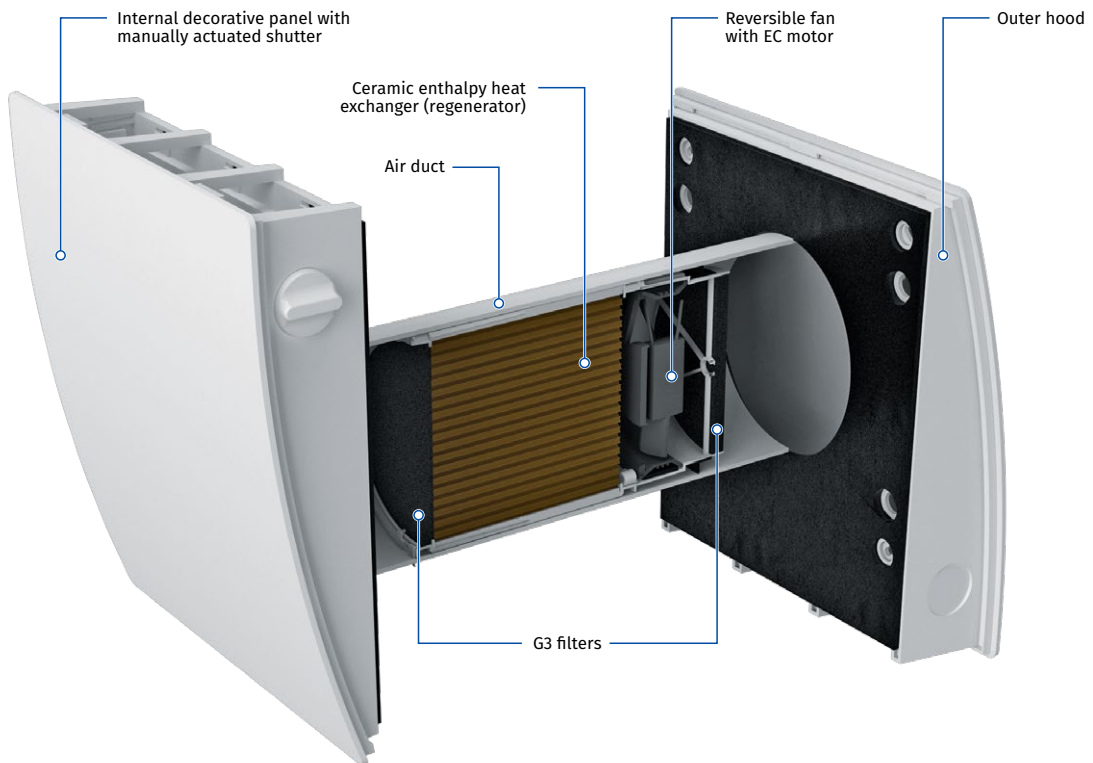

One of the best regeneration efficiency on the market due to innovative hexagonal structure of the heat exchanger cells

Designation key

Model	Air duct	Rated air flow [m ³ /h]	Internal grille type	Ventilation hood type	Control
Vento Eco	A: round air duct	30	4	S11: plastic hood for standard walls S: metal hood for thin walls	Pro: sensor control panel

VENTO ECO A30-4 S11 PRO

HEAT RECOVERY SINGLE-ROOM UNITS

Heat and humidity regeneration

UNIT OPERATING LOGIC IN WINTER PERIOD

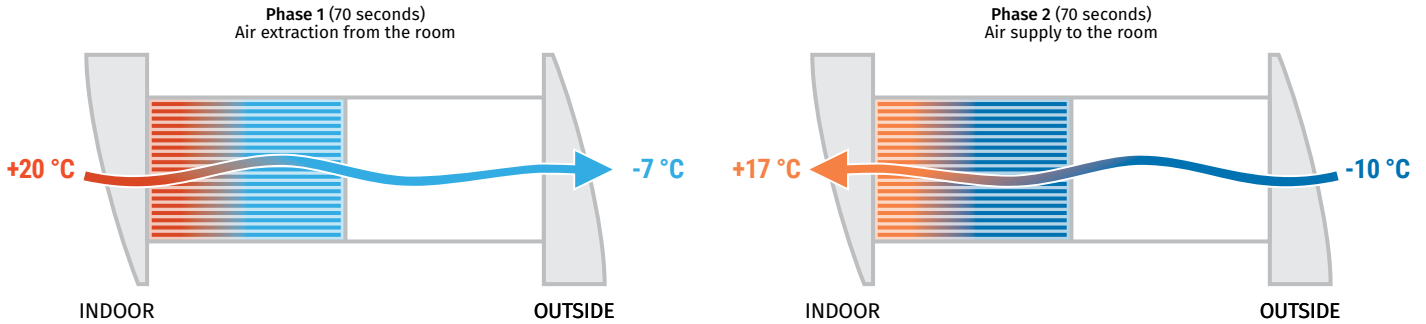

- Warm stale air is extracted from the premise, flows through the ceramic regenerator and transfers its heat energy and moisture to it.
- As the ceramic regenerator gets warmed up, the unit switches to the supply mode.
- Clean cold intake air flows through the regenerator and absorbs accumulated heat and humidity.
- When the ceramic regenerator is cooled down, the unit switches to the extract air mode.

Control

- Control of the unit operation mode is performed by means of the sensor control panel.

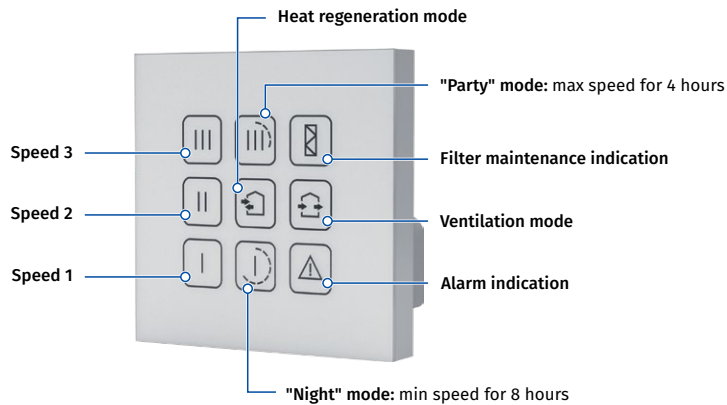

- One control panel with sensor buttons can control up to two units.
- Low voltage (12 V) power supply between control panel and **Vento Eco** units.

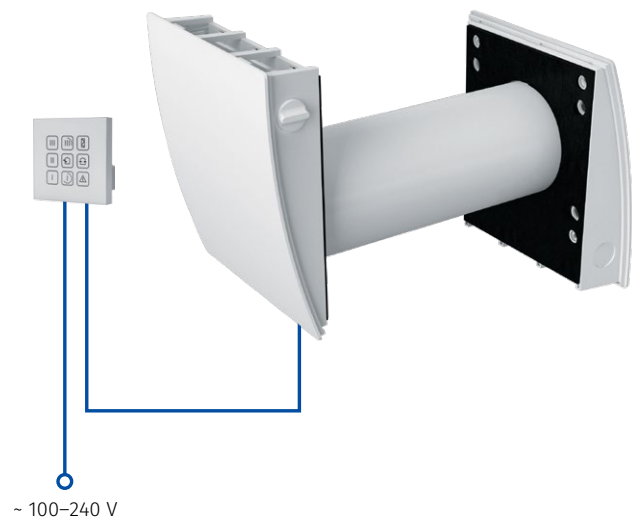

VENTO ECO A30-4 S11 PRO

HEAT RECOVERY SINGLE-ROOM UNITS

Mounting

- The unit is designed for through-the-wall installation inside a prepared hole in an outer wall of the building.
- One unit is able to ventilate a room up to 15 m². For bigger rooms two or more units must be installed.
- The best ventilation solution is pairwise installation of reverse phase synchronized units. One unit ensures supply of fresh air to the room and the other one extracts air from the premise. This way the most efficient balanced ventilation is arranged.

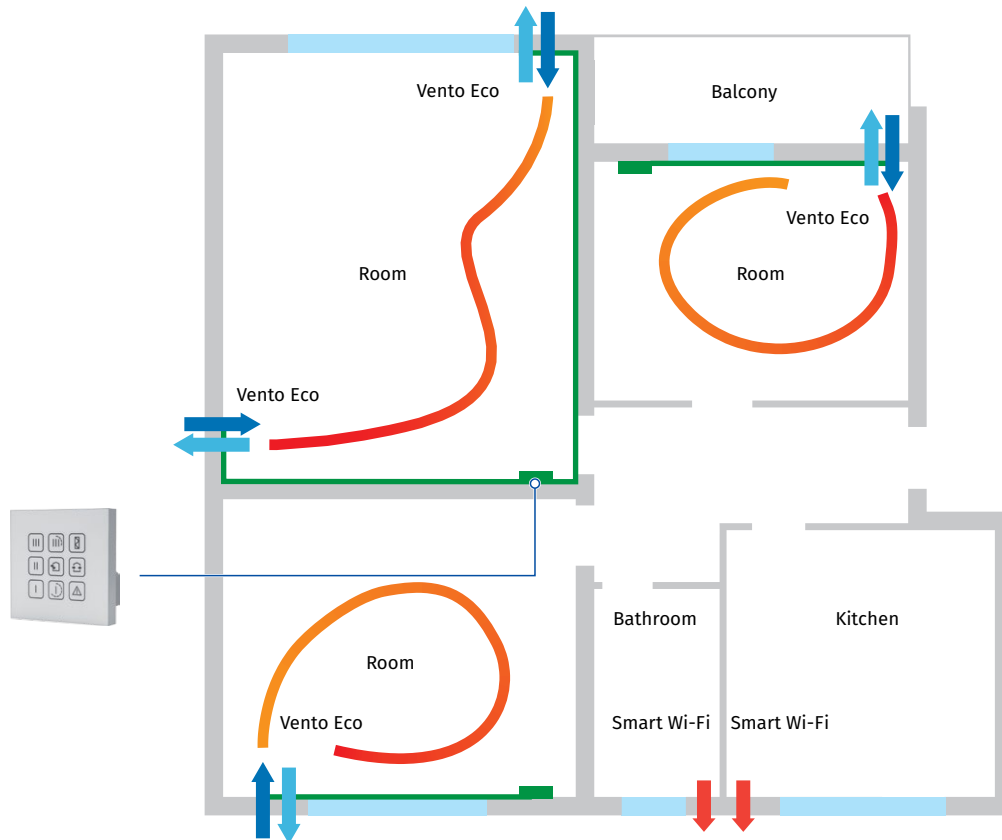

VENTO ECO A30-4 S11 PRO

HEAT RECOVERY SINGLE-ROOM UNITS

Technical data

Parameters	Vento Eco A30-4 S11 Pro Vento Eco A30-4 S Pro		
	I	II	III
Speed			
Voltage [V / 50 (60) Hz]		100-240	
Power [W]	1.03	1.96	3.47
Current [A]	0.021	0.027	0.038
RPM [min ⁻¹]	1600	2200	2500
Air flow in ventilation mode [m ³ /h (l/s)]	10 (3)	20 (6)	30 (8)
Air flow in heat recovery mode [m ³ /h (l/s)]	5 (1)	10 (3)	15 (4)
SFP [W/l/s]	0.74	0.71	0.83
Transported air temperature [°C]		-20...+40	
Heat recovery efficiency according to DIBt LÜ-A 20 [%]		up to 81	
Outdoor sound pressure attenuation according to DIN EN 20140 [dBA]		42	
Indoor/outdoor airtightness classification of the complete unit in accordance with EN 13141-8		D1	
Sound pressure level at 1 m according to ISO 3741: 2004 [dBA]	30	37	40
Sound pressure level at 3 m according to ISO 3741: 2004 [dBA]	21	28	31
Ingress protection rating		IP24	

BLAUBERG Vento Eco A30-4 S11 Pro

ENERGIA - ЕНЕРГИЯ - ΕΝΕΡΓΕΙΑ - ENERGIJA - ENERGI - ENERGIJE - ENERGI

2020 1254/2014



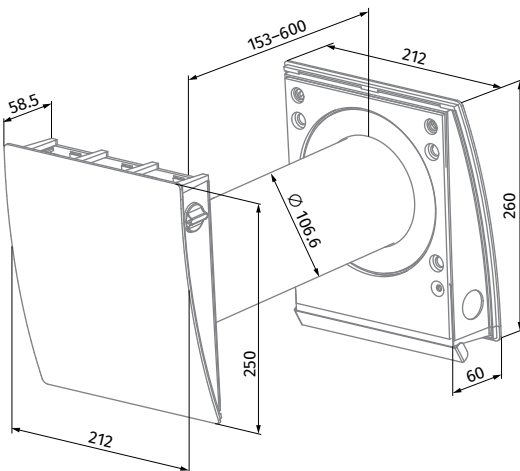







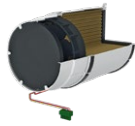

Overall dimensions [mm]



VENTO ECO A30-4 S11 PRO



HEAT RECOVERY SINGLE-ROOM UNITS

Accessories

Name		Description
Completion Kit Vento Eco A30-4		Indoor grille and cartridge with heat regenerator, fan and G3 filters
ZL1 Vento 100		Cartridge with heat regenerator for cold climate
FP2 Vento G3		G3 filters (2 pcs.)
AH-8 white 100		White painted aluminium outer ventilation hood with frost protection for a cold climate
AH-8 chrome 100		Brushed stainless steel outer ventilation hood with frost protection for a cold climate
AH-10 *colour* 100		Plastic outer ventilation hood. Available in colours: 
AH-10 chrome 100		Plastic outer ventilation hood with a plate with brushed stainless steel effect finish
AH-11 *colour* 100		Plastic outer ventilation hood. Available in colours: 
AH-S chrome 100		Outer ventilation hood for thin wall made of brushed stainless steel
AH-S white 100		Outer ventilation hood for thin wall made of stainless steel, painted white
KIT BlauPlast white 100		Kit for angular mounting with white colour grille (for walls with standard thickness)
KIT BlauPlast chrome 100		Kit for angular mounting with stainless steel outer grille (for walls with standard thickness)

VENTO ECO A30-4 S11 PRO

HEAT RECOVERY SINGLE-ROOM UNITS

Name		Description
BlauPlast RTR 100/0.35-0.5		Telescopic air duct with the diameter of 100 mm and adjustable length from 350 to 500 mm
BlauPlast RTR 100/0.5-1		Telescopic air duct with the diameter of 100 mm and adjustable length from 500 to 1000 mm
SE Vento Eco A30 Pro		Sensor control panel

VENTO ERGO A50-1 PRO V.3

HEAT RECOVERY SINGLE-ROOM UNITS

Features

- Arrangement of efficient energy-saving supply and exhaust single-room ventilation in flats, houses, cottages, social and commercial premises.
- Heat recovery minimises ventilation heat losses.
- Humidity balance and controllable air exchange create individually set micro-climate.
- Coordinated network based on several integrated single-room ventilation units with central control.



Air flow:
up to 50 m³/h
14 l/s



Heat recovery efficiency:
up to 88 %



Power: from 4.50 W
SFP: from 1.01 W/l/s



Noise level:
from 13 dBA



Design

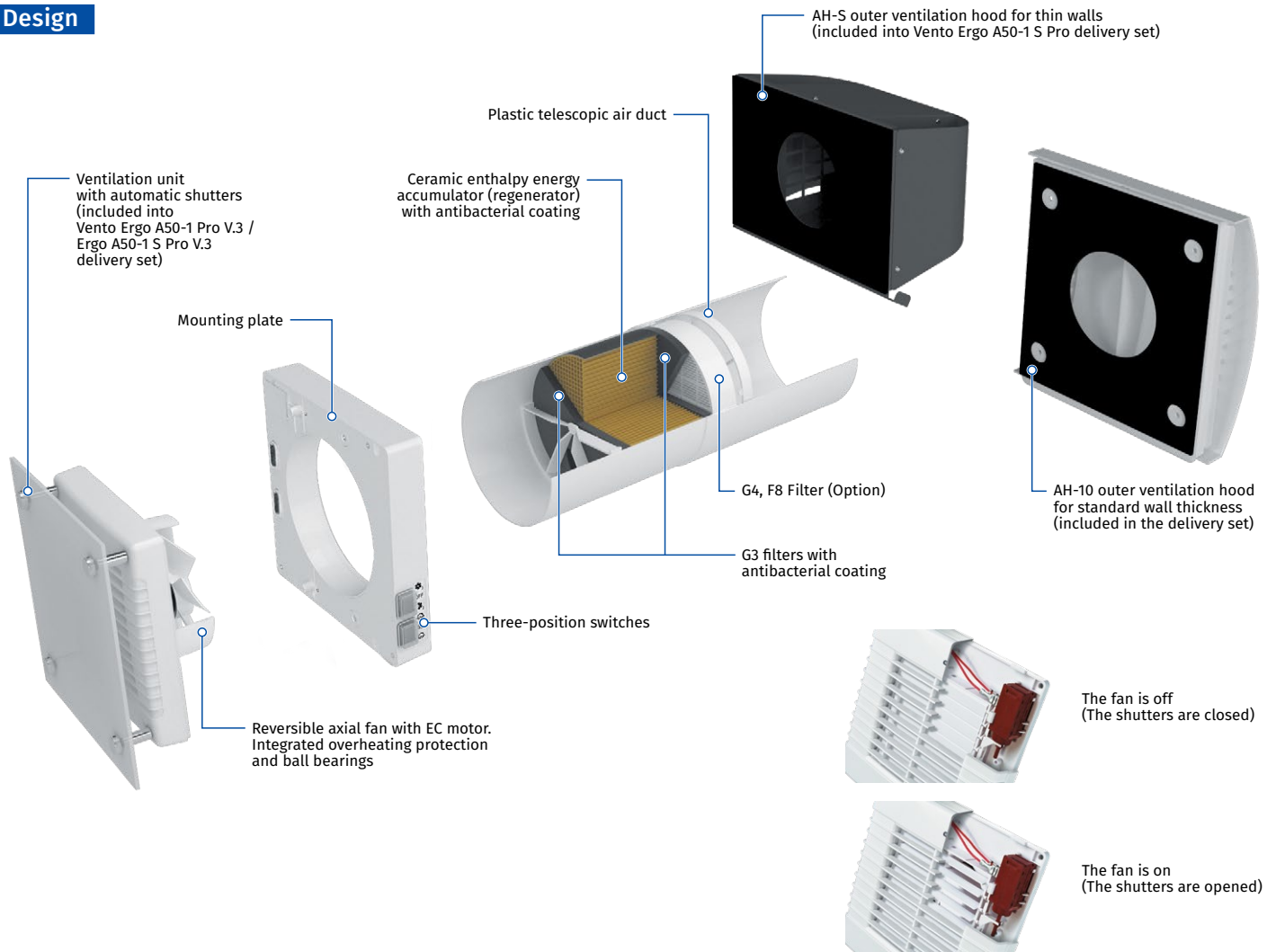

Designation key

Model	Air duct	Rated air flow [m ³ /h]	Front panel	Hood type	Control	Version
Vento Ergo	A: round air duct	50	- 1: flat front panel	_: white plastic hood AH-10 white 100 (for standard walls) S: AH-S chrome 150 metal hood for thin walls	Pro: three-position switches and remote control	V.3: plastic mounting plate, two boards, fuse on board

VENTO ERGO A50-1 PRO V.3

HEAT RECOVERY SINGLE-ROOM UNITS

Heat and humidity regeneration

- High-tech ceramic energy accumulator with heat recovery up to 88 %.
- Due to its cellular structure it has a larger heat transfer area surface and high efficiency. The energy accumulator is featured with excellent heat-conducting properties and thermal energy storage capacity.

UNIT OPERATING LOGIC IN WINTER PERIOD

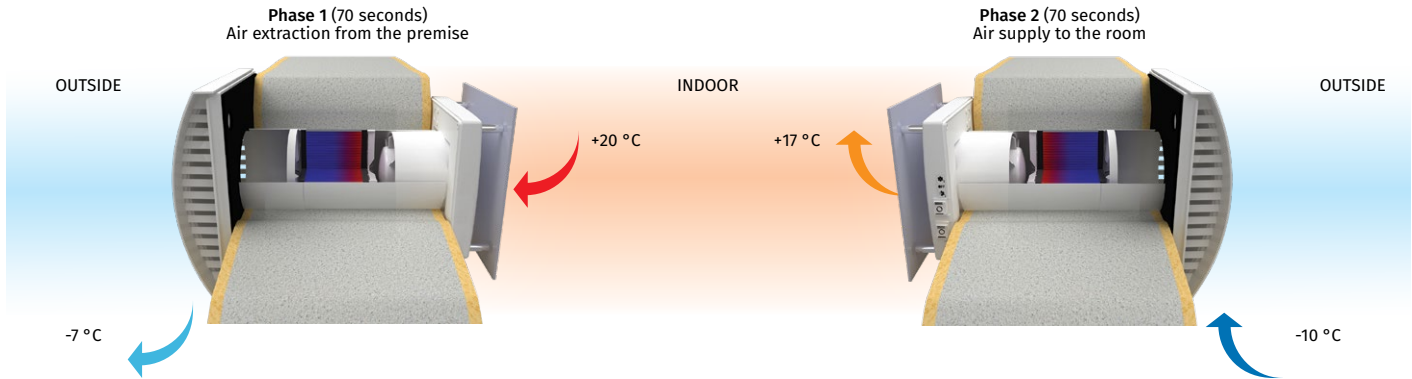

- Warm stale air is extracted from the premise, flows through the ceramic regenerator and transfers a part of the accumulated heat and moisture to it.
- In 70 seconds, after heating of the ceramic regenerator, the unit switches to the supply mode.
- Clean cold intake air flows through the regenerator and absorbs accumulated heat and humidity.
- In 70 seconds, after cooling of the ceramic regenerator, the unit is switched to the extract air mode.

Control

- The unit operation mode control is performed by means of manual three-position switches located on the unit casing or using the remote controller.
- The unit is equipped with a humidity sensor for indoor humidity control and regulation.
- Connection of the units into one ventilation system provide balanced ventilation and central control.
- Remote control and operation mode selection:

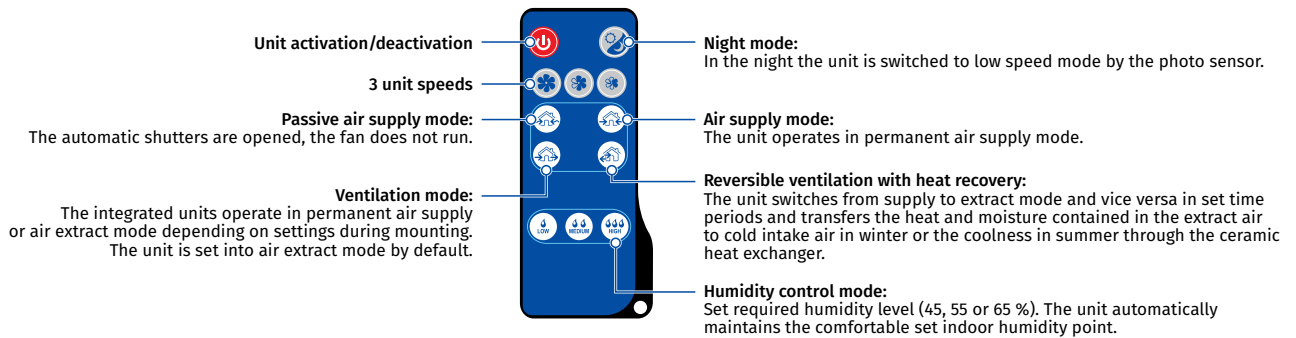
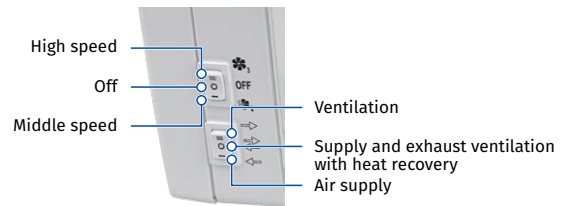

- Connection of several units in series enables their synchronous control by the first unit. The signal from the remote control is received by the first unit only.

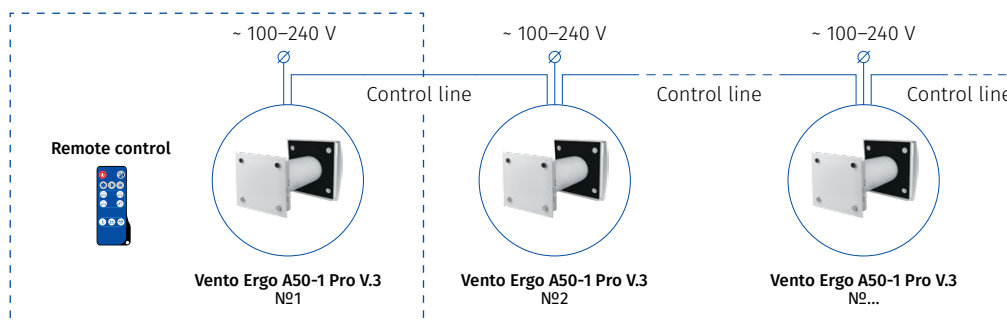

VENTO ERGO A50-1 PRO V.3

HEAT RECOVERY SINGLE-ROOM UNITS

Mounting

- The unit is designed for external through-the-wall installation inside a prepared round hole in the outer wall of the building.
- The best ventilation solution is pairwise installation of reverse phase connected units. Some units supply fresh air to the room and the other units extract stale air from the room. This allows to arrange the most efficient balanced ventilation.
- In case of brand new construction the units are mounted in two stages:
 - **pre-installation** at the stage of the indoor finishing and outer decorative wall finishing. It includes installation of the telescopic air ducts, outer ventilation hood and laying out of electric cables.
 - **final mounting** before commissioning of a house. It includes installation of the regenerator, the filters, connection of the ventilation unit.
- If mounting of the ventilation hood on the outer wall is undesirable it may be flush mounted and the external grille may be inserted into the outer window jamb using the **KIT BlauPlast 204x60-1** pre-installation kit. Available upon separate order.

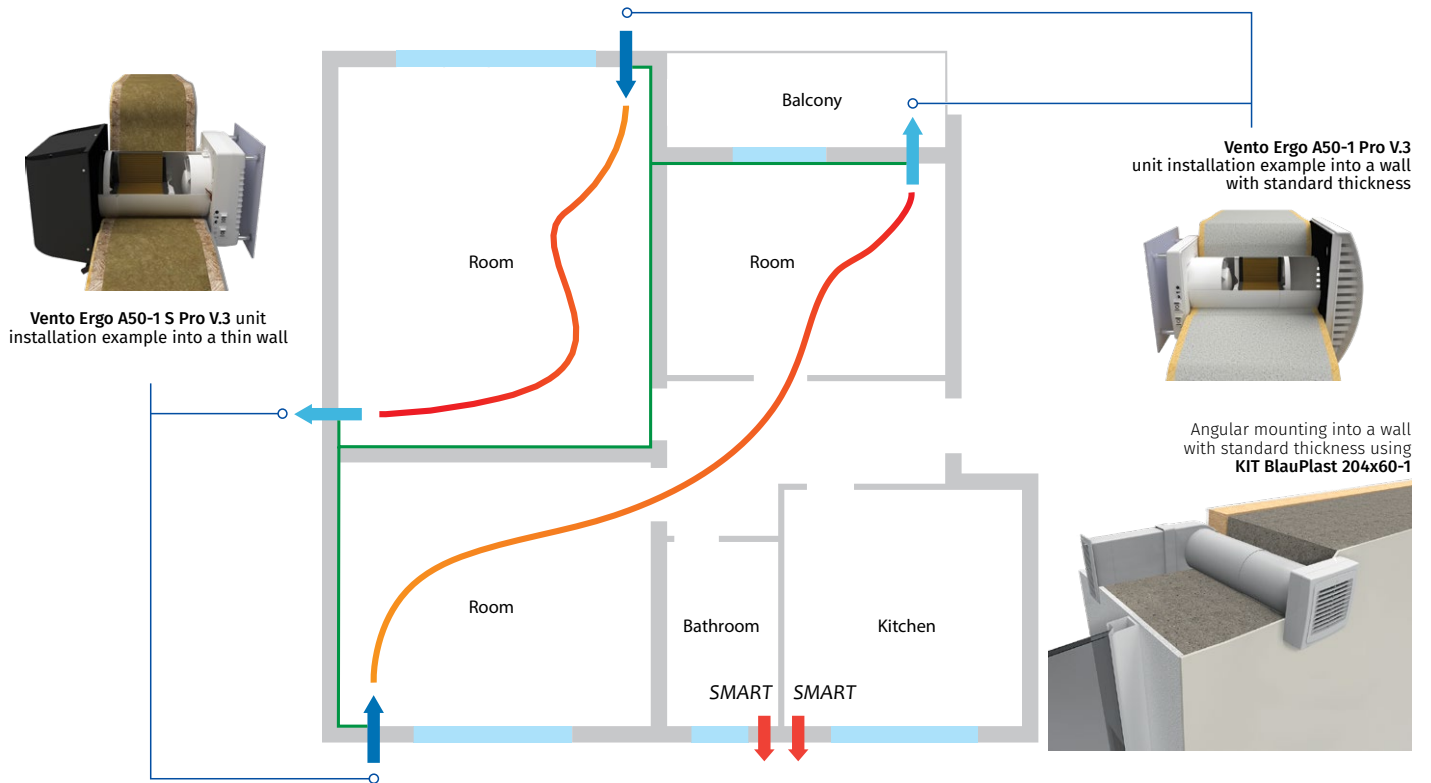

VENTO ERGO A50-1 PRO V.3

HEAT RECOVERY SINGLE-ROOM UNITS

Technical data

Parameters	Vento Ergo A50-1 Pro V.3		
	I	II	III
Speed			
Voltage [V / 50 (60) Hz]	1 ~ 100-240		
Power [W]	4.5	5	7
Current [A]	0.024	0.026	0.039
RPM [min ⁻¹]	610	800	1450
Maximum air flow [m ³ /h (l/s)]	20 (6)	35 (10)	50 (14)
Air flow in heat recovery mode [m ³ /h (l/s)]	10 (3)	18 (5)	25 (7)
SFP [W/l/s]	1.62	1.03	1.01
Filter	G3 (Option: G4, F8 PM2.5 > 99 %*)		
Outdoor sound pressure attenuation according to DIN EN 20140 [dBA]	40		
Sound pressure level at 1 m according to ISO 3741: 2004 [dBA]	22	29	32
Sound pressure level at 3 m according to ISO 3741: 2004 [dBA]	13	20	23
Heat recovery efficiency according to DIBt LÜ-A 20 [%]	up to 88		
Transported air temperature [°C]	-20...+40		
Ingress protection rating	IP24		

* maximum air flow 40 m³/h

ENERGY LABEL: A (Energy efficiency), 36.7 dB (Sound power level), 25 m³/h (Air flow)

Overall dimensions [mm]

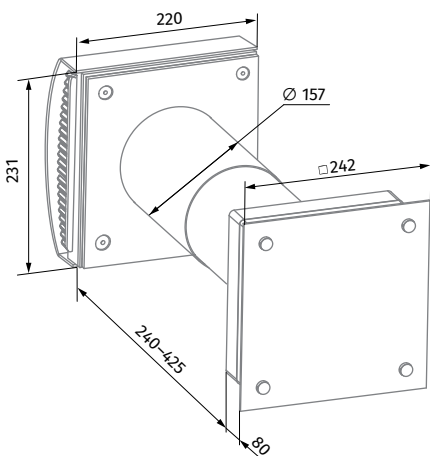

Vento Ergo A50-1 Pro V.3

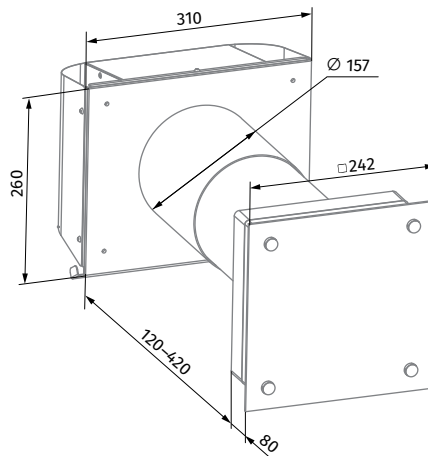

































Vento Ergo A50-1 S Pro V.3

VENTO ERGO A50-1 PRO V.3

HEAT RECOVERY SINGLE-ROOM UNITS

Accessories

Name		Description												
Pre-installation Kit Vento Ergo A50 S10 Pro		Pre-installation kit for mounting into a wall with standard thickness. Includes: <ul style="list-style-type: none"> • Round telescopic air duct with the diameter of 150 mm and adjustable length from 240 to 460 mm • AH-10 white 160 outer ventilation hood • Plastic foam plug • Plastic foam wedges 												
Completion Kit Vento Ergo A50-1 Pro V.3		Includes: <ul style="list-style-type: none"> • Ceramic regenerator \varnothing 150 mm • Vento Ergo A50-1 ventilation unit • G3 filters • Mounting plate • Remote control 												
FP Vento Ergo A50 G3		G3 filters (2 pcs.)												
FPC 150x50 G4		G4 filter												
FP Vento Ergo A50 F8		F8 filter												
AH-8 white 150		White painted aluminium outer ventilation hood with frost protection for a cold climate												
AH-8 chrome 150		Brushed stainless steel outer ventilation hood with frost protection for a cold climate												
AH-10 *colour* 160		Plastic outer ventilation hood. Available in colours: <table style="display: inline-table; vertical-align: middle; margin-left: 10px;"> <tr> <td></td> <td></td> <td></td> <td></td> <td></td> <td></td> </tr> <tr> <td>white</td> <td>black</td> <td>grey</td> <td>terracotta</td> <td>brown</td> <td>vintage</td> </tr> </table>							white	black	grey	terracotta	brown	vintage
														
white	black	grey	terracotta	brown	vintage									
AH-10 chrome 160		Plastic outer ventilation hood with a plate with brushed stainless steel effect finish												
AH-S grey 150		Outer ventilation hood for thin wall, painted grey												
AH-S chrome 150		Outer ventilation hood for thin wall made of brushed stainless steel												
PP 160/0.5		Outer ventilation hood for mounting from inside												
KIT BlauPlast 204x60-1		Installation kit for angular mounting. Includes: <ul style="list-style-type: none"> • Plastic ventilation grille 230x86 mm • Plastic air duct 204x60 mm • Plastic connecting bend from \varnothing 150 to 204x60 mm 												
FB Vento Ergo		Remote control												

VENTO ERGO A85-1 PRO V.3

HEAT RECOVERY SINGLE-ROOM UNITS

Features

- Arrangement of efficient energy-saving supply and exhaust single-room ventilation in flats, houses, cottages, social and commercial premises.
- Heat recovery minimises ventilation heat losses.
- Humidity balance and controllable air exchange create individually set micro-climate.
- Coordinated network based on several integrated single-room ventilation units with central control.



Air flow:
up to 85 m³/h
24 l/s



Heat recovery efficiency:
up to 90 %



Power: from 4.74 W
SFP: from 0.80 W/l/s



Noise level:
from 19 dBA



Design

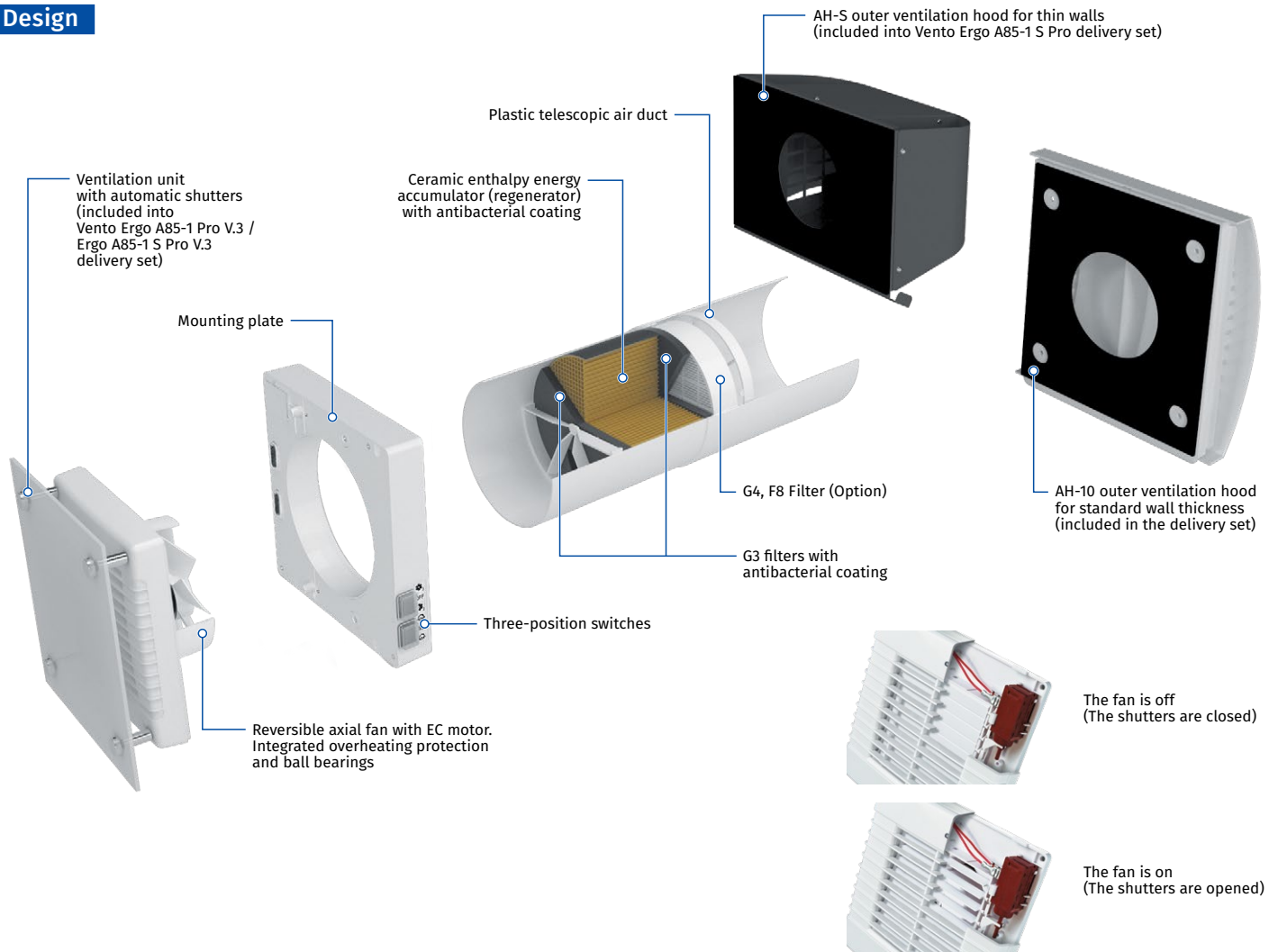

Designation key

Model	Air duct	Rated air flow [m ³ /h]	Front panel	Hood type	Control	Version
Vento Ergo	A: round air duct	85	- 1: flat front panel	_: white plastic hood AH-10 white 100 (for standard walls) S: AH-S chrome 150 metal hood for thin walls	Pro: three-position switches and remote control	V.3: plastic mounting plate, two boards, fuse on board

VENTO ERGO A85-1 PRO V.3

HEAT RECOVERY SINGLE-ROOM UNITS

Heat and humidity regeneration

- High-tech ceramic energy accumulator with heat recovery up to 90 %.
- Due to its cellular structure it has a larger heat transfer area surface and high efficiency.

UNIT OPERATING LOGIC IN WINTER PERIOD

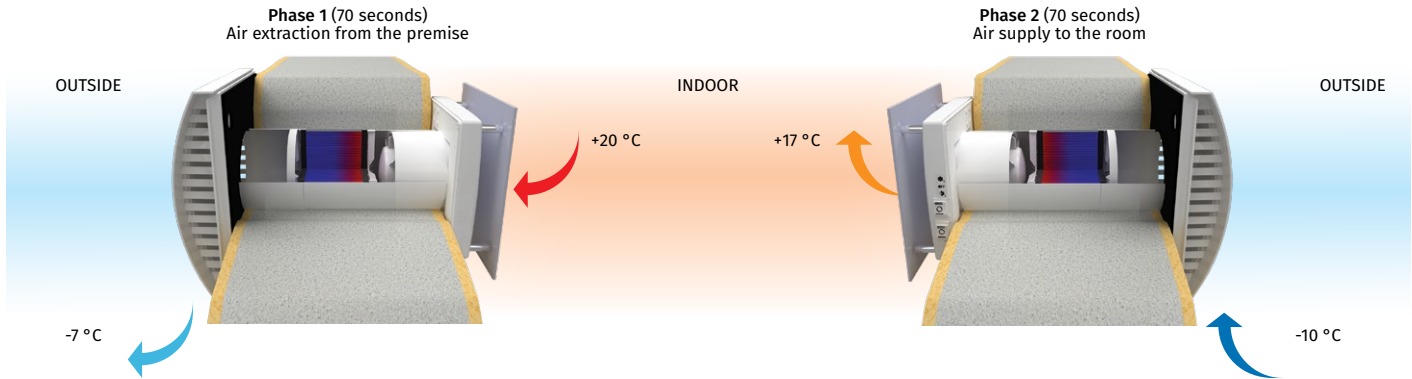

- Warm stale air is extracted from the premise, flows through the ceramic regenerator and transfers a part of the accumulated heat and moisture to it.
- In 70 seconds, after heating of the ceramic regenerator, the unit switches to the supply mode.
- Clean cold intake air flows through the regenerator and absorbs accumulated heat and humidity.
- In 70 seconds, after cooling of the ceramic regenerator, the unit is switched to the extract air mode.

Control

- The unit operation mode control is performed by means of manual three-position switches located on the unit casing or using the remote controller.
- The unit is equipped with a humidity sensor for indoor humidity control and regulation.
- Connection of the units into one ventilation system provide balanced ventilation and central control.
- Remote control and operation mode selection:

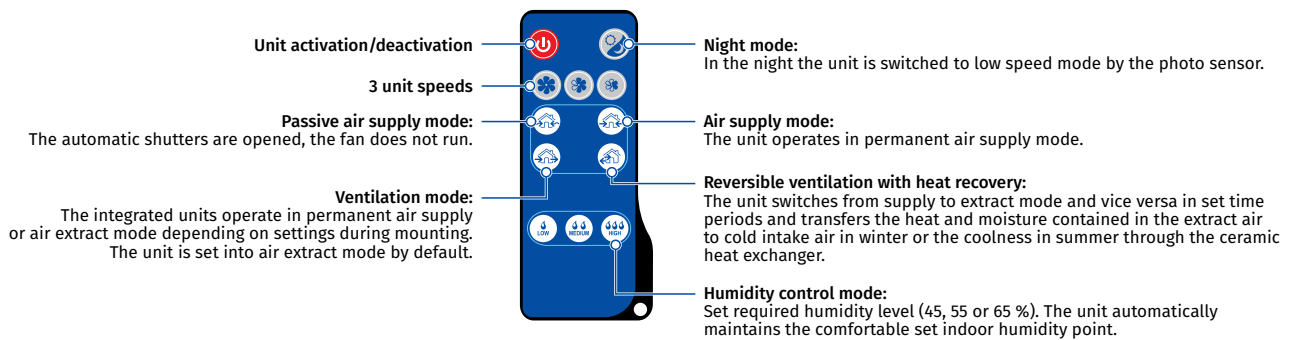
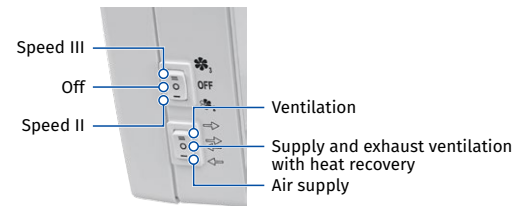

- Connection of several units in series enables their synchronous control by the first unit. The signal from the remote control is received by the first unit only.

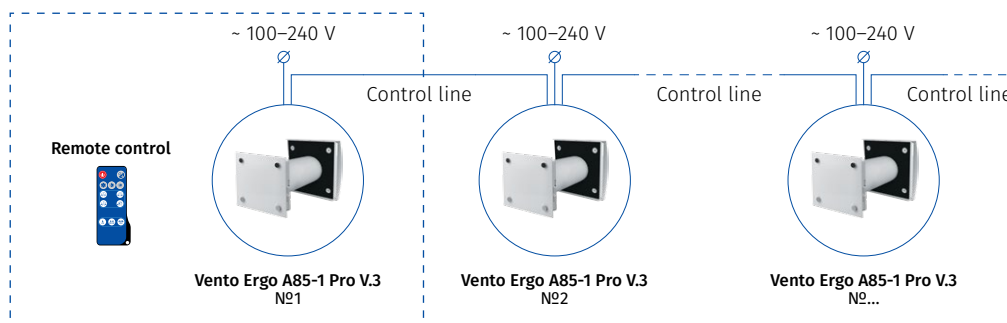

VENTO ERGO A85-1 PRO V.3

HEAT RECOVERY SINGLE-ROOM UNITS

Mounting

- The unit is designed for external through-the-wall installation inside a prepared round hole in the outer wall of the building.
- The best ventilation solution is pairwise installation of reverse phase connected units. Some units supply fresh air to the room and the other units extract stale air from the room. This allows to arrange the most efficient balanced ventilation.
- In case of brand new construction the units are mounted in two stages:
 - **pre-installation** at the stage of the indoor finishing and outer decorative wall finishing. It includes installation of the telescopic air ducts, outer ventilation hood and laying out of electric cables.
 - **final mounting** before commissioning of a house. It includes installation of the regenerator, the filters, connection of the ventilation unit.
- If mounting of the ventilation hood on the outer wall is undesirable it may be flush mounted and the external grille may be inserted into the outer window jamb using the **KIT BlauPlast 204x60-1** pre-installation kit. Available upon separate order.

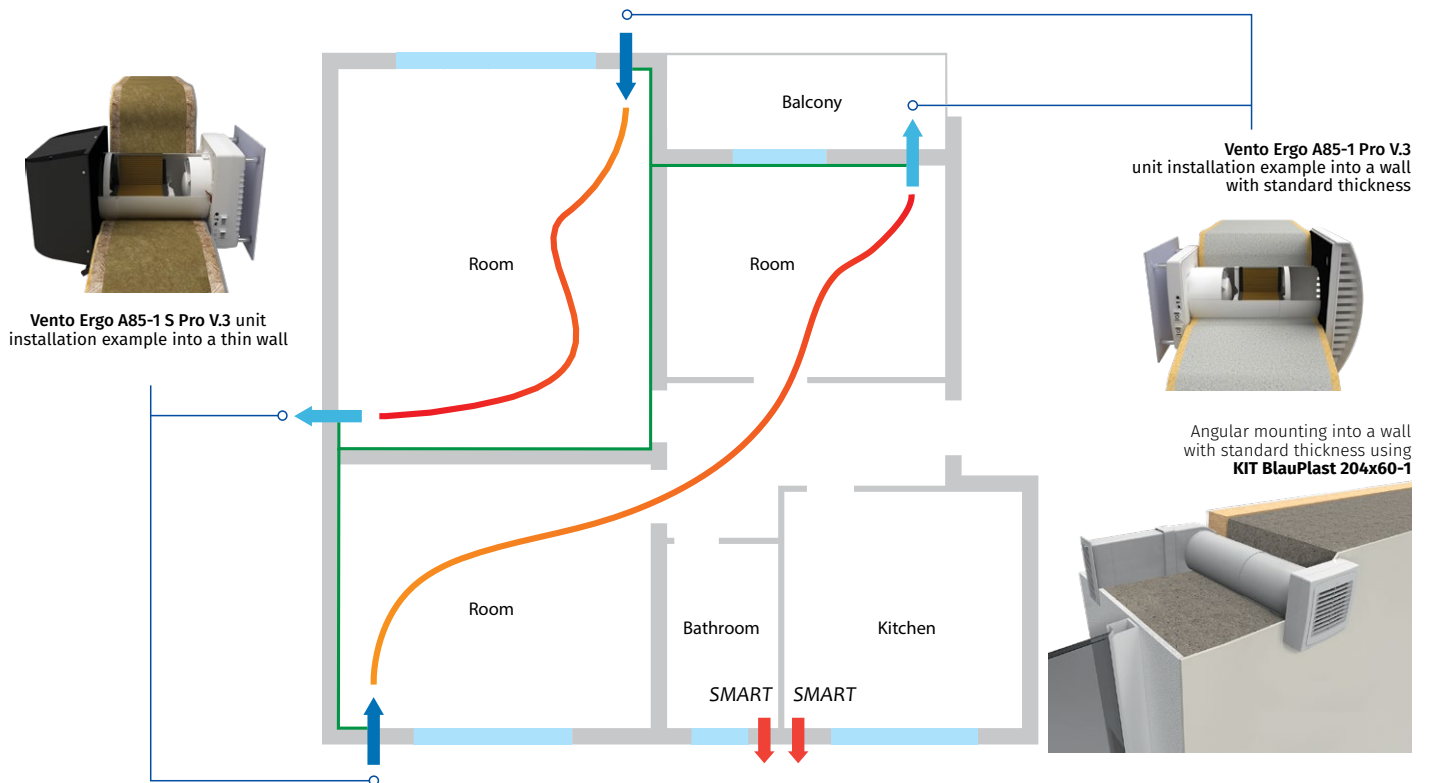

VENTO ERGO A85-1 PRO V.3

HEAT RECOVERY SINGLE-ROOM UNITS

Technical data

Parameters	Vento Ergo A85-1 Pro V.3		
	I	II	III
Speed			
Voltage [V / 50 (60) Hz]	1 ~ 100-240		
Power [W]	4.74	6.56	9.65
Current [A]	0.034	0.050	0.071
RPM [min ⁻¹]	1000	1500	2045
Maximum air flow [m ³ /h (l/s)]	36 (10)	59 (16)	85 (24)
Air flow in heat recovery mode [m ³ /h (l/s)]	18 (5)	30 (8)	43 (12)
SFP [W/l/s]	0.95	0.80	0.82
Filter	G3 (Option: G4, F8 PM2.5 > 99 %*)		
Outdoor sound pressure attenuation according to DIN EN 20140 [dBA]	40		
Sound pressure level at 1 m according to ISO 3741: 2004 [dBA]	29	35	44
Sound pressure level at 3 m according to ISO 3741: 2004 [dBA]	19	25	34
Heat recovery efficiency according to DIBt LÜ-A 20 [%]	up to 90		
Transported air temperature [°C]	-20...+40		
Ingress protection rating	IP24		

* maximum air flow 40 m³/h

ENERGY LABEL: A (Energy efficiency), 45 dB (Sound power level), 43 m³/h (Air flow)

Overall dimensions [mm]

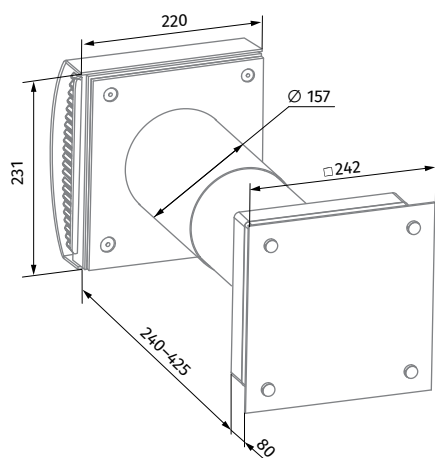

Vento Ergo A85-1 Pro V.3

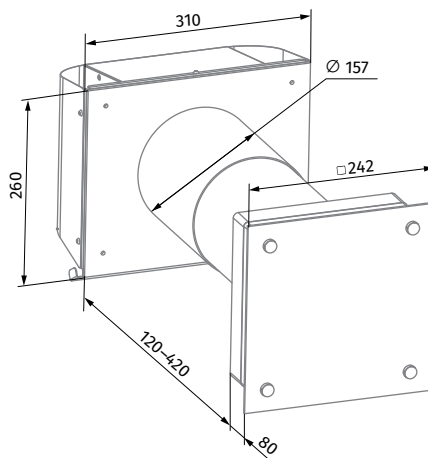































Vento Ergo A85-1 S Pro V.3

VENTO ERGO A85-1 PRO V.3

HEAT RECOVERY SINGLE-ROOM UNITS

Accessories

Name		Description												
Pre-installation Kit Vento Ergo A50 S10 Pro		Pre-installation kit for mounting into a wall with standard thickness. Includes: <ul style="list-style-type: none"> • Round telescopic air duct with the diameter of 150 mm and adjustable length from 240 to 460 mm • AH-10 white 160 outer ventilation hood • Plastic foam plug • Plastic foam wedges 												
Completion Kit Vento Ergo A85-1 Pro V.3		Includes: <ul style="list-style-type: none"> • Ceramic regenerator \varnothing 150 mm • Vento Ergo A85-1 ventilation unit • G3 filters • Mounting plate • Remote control 												
FP Vento Ergo A50 G3		G3 filters (2 pcs.)												
FPC 150x50 G4		G4 filter												
FP Vento Ergo A50 F8		F8 filter												
AH-10 *colour* 160		Plastic outer ventilation hood. Available in colours: <table style="display: inline-table; vertical-align: middle;"> <tr> <td></td> <td></td> <td></td> <td></td> <td></td> <td></td> </tr> <tr> <td>white</td> <td>black</td> <td>grey</td> <td>terracotta</td> <td>brown</td> <td>vintage</td> </tr> </table>							white	black	grey	terracotta	brown	vintage
														
white	black	grey	terracotta	brown	vintage									
AH-10 chrome 160		Plastic outer ventilation hood with a plate with brushed stainless steel effect finish												
AH-S grey 160		Outer ventilation hood for thin wall, painted grey												
AH-S chrome 160		Outer ventilation hood for thin wall made of brushed stainless steel												
PP 160/0.5		Outer ventilation hood for mounting from inside												
KIT BlauPlast 204x60-1		Installation kit for angular mounting. Includes: <ul style="list-style-type: none"> • Plastic ventilation grille 230x86 mm • Plastic air duct 204x60 mm • Plastic connecting bend from \varnothing 150 to 204x60 mm 												
FB Vento Ergo		Remote control												

SOLO A35 S4 PRO R

WALL VENTS

Features

- Wall ventilator with heat and energy recovery.
- Supply clean fresh air to the premises.
- Remove stale extract air from the premise.
- Clean the air of dust and insects.
- Prevent penetration of excessive humidity and appearance of mould.
- Protect against outdoor noise.
- Recover heat and provide humidity balance inside.
- Reduce the heating costs in winter and air conditioning costs in summer.
- Low energy demand.



Air flow:
up to 46 m³/h
13 l/s



Heat recovery efficiency:
up to 85 %



Power: from 1.20 W
SFP: from 0.27 W/l/s



Noise level:
from 27 dBA



Design

FAN

- Air is supplied or extracted by a reversible axial fan with EC motor. Due to EC technology the fan is distinguished with low energy demand. The motor has overheating protection and ball bearings for longer service life.

AIR FILTERS

- Two built-in filters with total filter class G3 are used to clean supply and extract air flows. The filters ensure fresh air cleaning of dust and insects and prevent the ventilator parts from soiling. The filters are cleaned either with a vacuum cleaner or flushed with water.

ENERGY HEAT EXCHANGER

- The high-technology ceramic energy heat exchanger with recovery efficiency up to 85 % is used for extract air heat energy recovery and supply air heating.

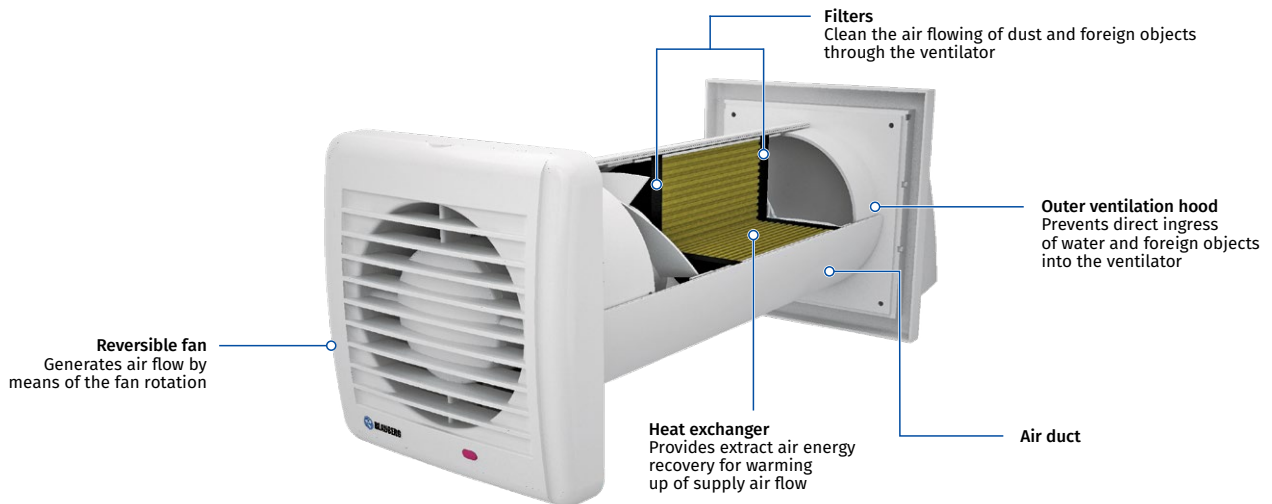

Operation logic

- Energy is recovered due to reversing operation of the ventilator, which consists of two cycles:
- **CYCLE I.** As warm stale extract air flows through the ceramic heat exchanger, it heats up and moisturizes the heat exchanger. In 70 seconds as the ceramic heat exchanger gets warmed the ventilator automatically switches to Air Supply mode.
- **CYCLE II.** Fresh, cold intake air from outside flows through the ceramic heat exchanger, absorbs accumulated moisture and is heated to the room temperature. In 70 seconds as the heat exchanger gets cooled down, the ventilator switches to Air Extract mode and the cycle is renewed.
- The Air Supply and the Air Extract modes are switched every 70 seconds.

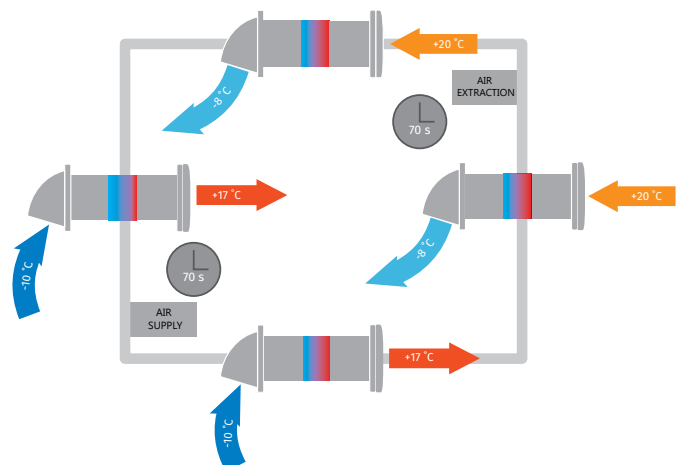

SOLO A35 S4 PRO R

WALL VENTS

Control

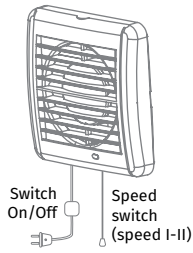

Technical data

Parameters	Solo A35 S4 Pro R Solo A35 L S4 Pro R	
	I	II
Speed	I	II
Voltage [V / 50 (60) Hz]	220-240	
Power [W]	1.20	1.70
Current [A]	0.019	0.025
Maximum air flow [m³/h (l/s)]	30 (8)	46 (13)
SFP [W/l/s]	0.29	0.27
Sound pressure level at 3 m distance [dBA]	27	32
Transported air temperature [°C]	-15...+40	
Heat recovery efficiency [%]	up to 85	
Heat exchanger type	Ceramic	
Ingress protection rating	IP24	



Overall dimensions [mm]

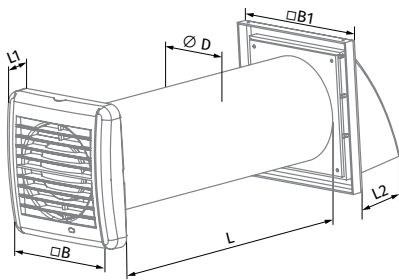

Model	Ø D	B	B1	L	L1	L2
Solo A35 S4 Pro R	103	150	153	305-380	30	84
Solo A35 L S4 Pro R	103	150	153	305-700	30	84

Mounting example

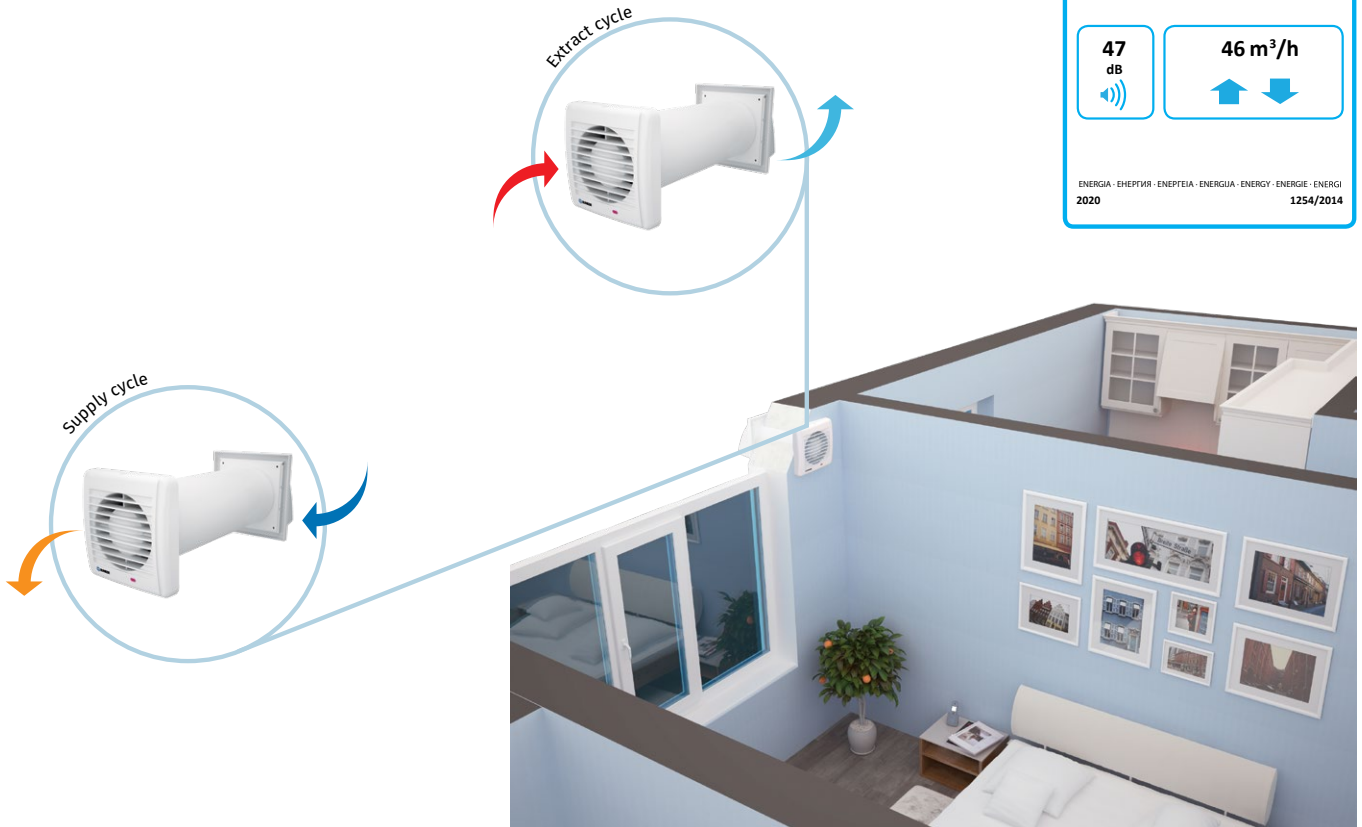

ENERG
енергия · енергид
IE IA

Y UA
IE IA

BLAUBERG Solo A35 S4 Pro R

A+

A

B

C

D

E

F

G

A

47
dB

46 m³/h

ENERGIA - ЕНЕРГИЯ - ΕΝΕΡΓΕΙΑ - ENERGIJA - ENERGI - ENERGIJE - ENERGI
2020 1254/2014

SOLO A35 S4 PRO R V.2

WALL VENTS

Features

- Wall ventilator with heat and energy recovery.
- Supply clean fresh air to the premises.
- Control via remote control.
- Remove stale extract air from the premise.
- Clean the air of dust and insects.
- Prevent penetration of excessive humidity and appearance of mould.
- Protect against outdoor noise.
- Heat return and ensuring the balance of humidity in the room thanks to the built-in humidity sensor.
- Reduce the heating costs in winter and air conditioning costs in summer.
- Low energy demand.



Air flow:
up to 46 m³/h
13 l/s



Heat recovery efficiency:
up to 85 %



Power: from 1.50 W
SFP: from 0.36 W/l/s



Noise level:
from 21 dBA



Design

FAN

- Air is supplied or extracted by a reversible axial fan with EC motor. Due to EC technology the fan is distinguished with low energy demand. The motor has overheating protection and ball bearings for longer service life.

AIR FILTERS

- Two built-in filters with total filter class G3 are used to clean supply and extract air flows. The filters ensure fresh air cleaning of dust and insects and prevent the ventilator parts from soiling. The filters are cleaned either with a vacuum cleaner or flushed with water.

ENERGY HEAT EXCHANGER

- The high-technology ceramic energy heat exchanger with recovery efficiency up to 85 % is used for extract air heat energy recovery and supply air heating.

HUMIDITY SENSOR

- Helps control the level of humidity in the room. When the sensor is activated, if the humidity in the room exceeds the set level, the ventilator switches to the second (higher) speed. The humidity sensor threshold can be adjusted by turning the potentiometer knob with a special plastic screwdriver. The humidity sensor can be switched on and off using the remote control.

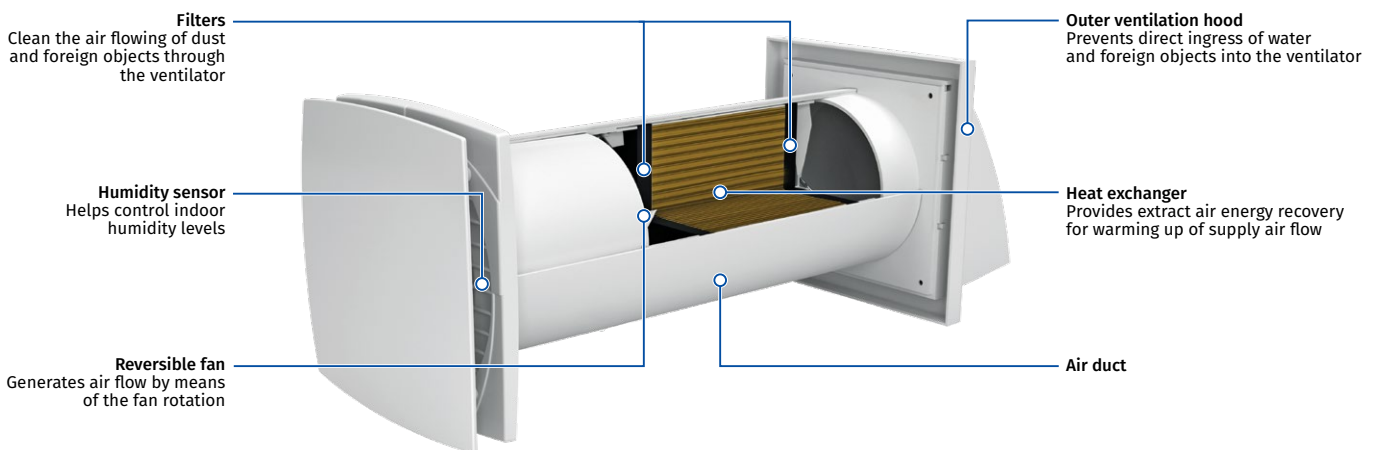

Operation logic

- Energy is recovered due to reversing operation of the ventilator, which consists of two cycles:
- **CYCLE I.** As warm stale extract air flows through the ceramic heat exchanger, it heats up and moisturizes the heat exchanger. In 60 seconds as the ceramic heat exchanger gets warmed the ventilator automatically switches to Air Supply mode.
- **CYCLE II.** Fresh, cold intake air from outside flows through the ceramic heat exchanger, absorbs accumulated moisture and is heated to the room temperature. In 60 seconds as the heat exchanger gets cooled down, the ventilator switches to Air Extract mode and the cycle is renewed.
- The Air Supply and the Air Extract modes are switched every 60 seconds.

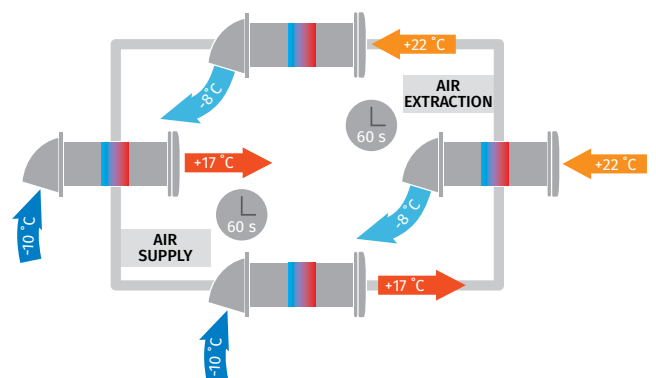

SOLO A35 S4 PRO R V.2

WALL VENTS

Control

The humidity sensor and speed are controlled by the remote control.

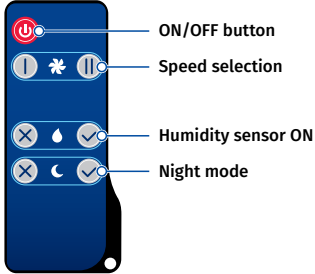

Technical data

Parameters	Solo A35 S4 Pro R V.2	
Speed	I	II
Voltage [V / 50 (60) Hz]	220-240	
Power [W]	1.50	2.30
Current [A]	0.046	0.047
Maximum air flow [m³/h (l/s)]	30 (8)	46 (13)
SFP [W/l/s]	0.36	0.36
Sound pressure level at 3 m distance [dBA]	21	26
Transported air temperature [°C]	-15...+40	
Heat recovery efficiency [%]	up to 85	
Heat exchanger type	Ceramic	
Ingress protection rating	IP24	



Overall dimensions [mm]

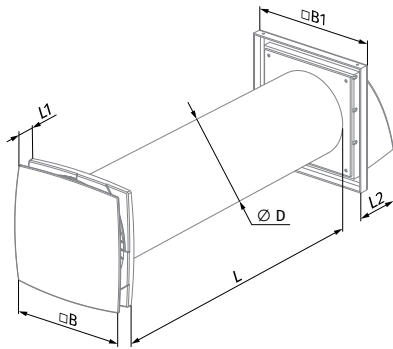

Model	Ø D	B	B1	L	L1	L2
Solo A35 S4 Pro R V.2	106	150	153	305-380	30	84

ENERGIA - ЕНЕРГИЯ - ΕΝΕΡΓΕΙΑ - ENERGIA - ENERGY - ENERGI - ENERGI
2020 1254/2014

Mounting example

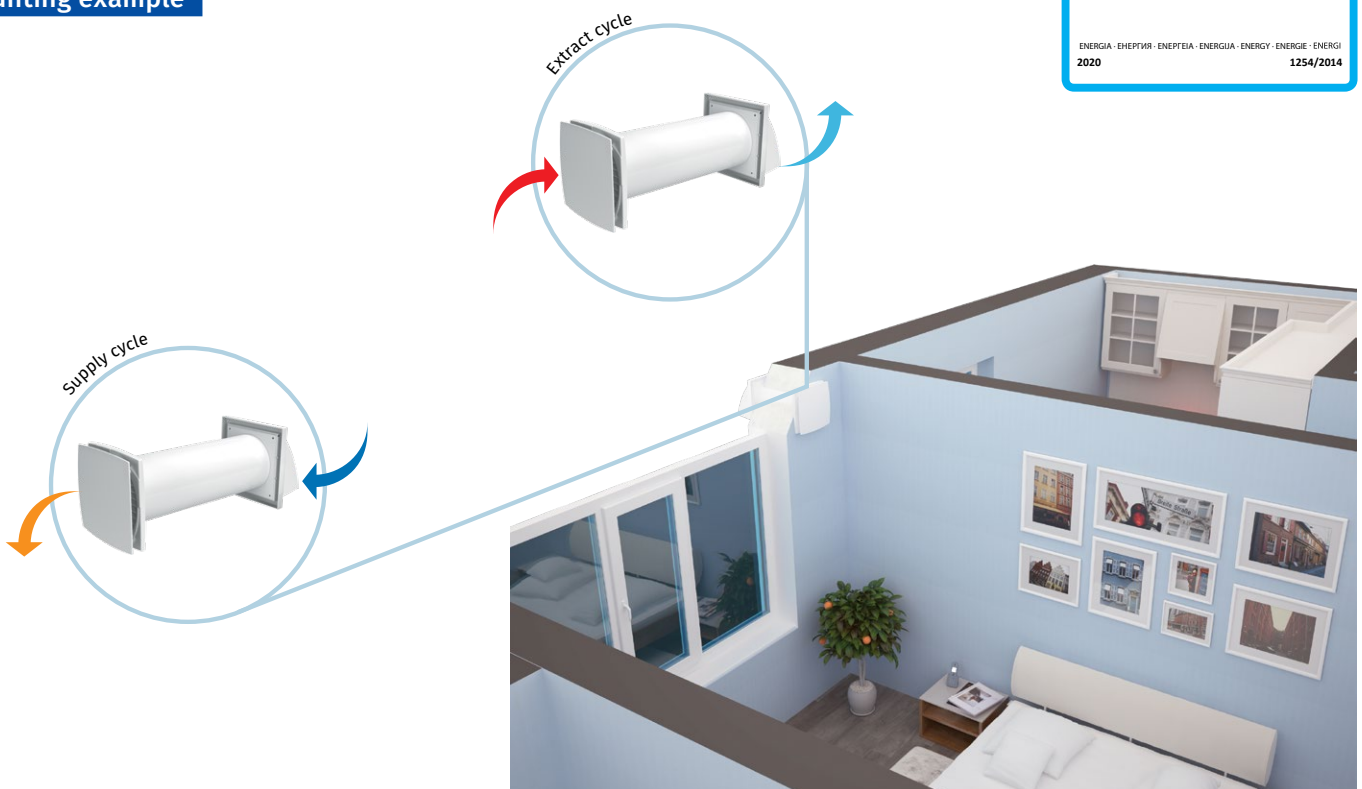

PP 160

OUTER VENTILATION HOOD MOUNTING FROM INSIDE

Features

- The outer hood is designed to prevent the ingress of water and large objects into the ventilation equipment from outside.
- Pre-installed with a hood the air duct is mounted in a hole drilled in the wall. The installation is done from the inside.
- Special design allows installation of the hood by the operator on a wall of high-rise buildings and enables airtight sealing of the air duct in the core hole.



Design

- Made of high-quality incombustible ultraviolet resistant plastic.
- Fixation at the end of the air duct with latches.
- The ventilation hood [1] is equipped with a silicone sealing ring [2] that provides high sealing integrity of the air duct [3] in the wall.
- The air duct with diameter of 160 mm is made of high-quality PVC plastic.

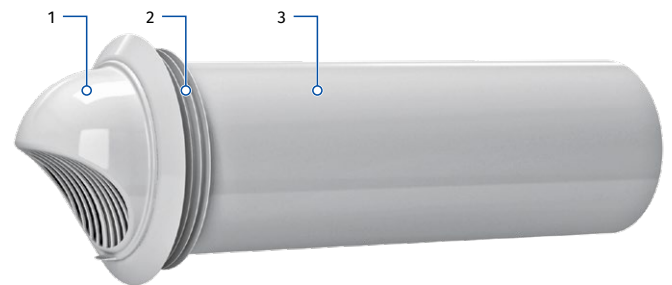

Heat and moisture regeneration

- Drill a hole with a diameter of 180 mm in the wall.
- Insert the hood into the wall core hole and push it until the sealing ring appears on the outer side.
- Pull the hood in the opposite direction so the silicone sealing ring provides tight seal between the hood and the wall.
- Install the air duct with the minimum slope of 2-3° downwards using foam wedges from the delivery set.
- The air duct must be fixed in the wall core hole using mounting foam.

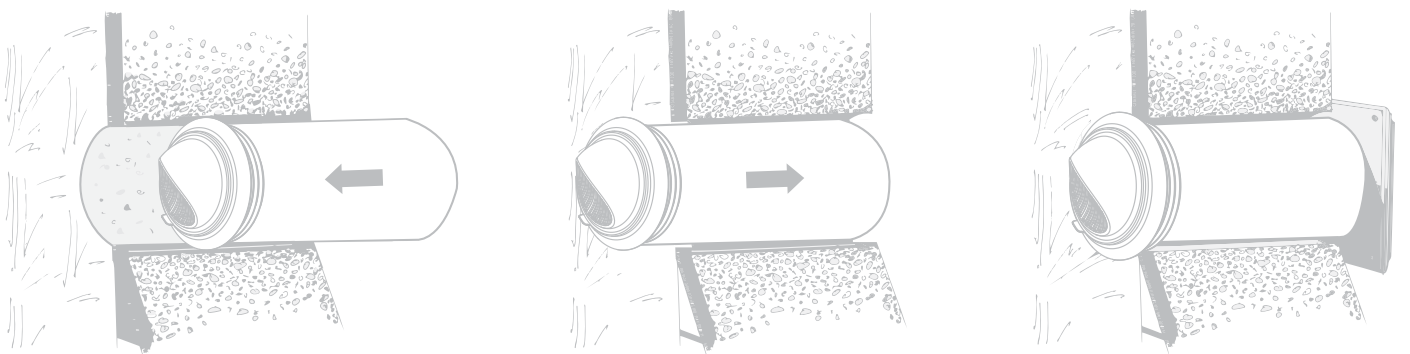

Overall dimensions [mm]

Model	Air duct length
PP 160/0.3	300
PP 160/0.5	500
PP 160/0.7	700
PP 160/0.8	800

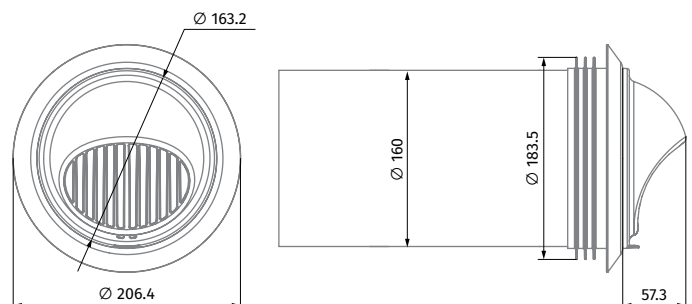

SE VENTO EXPERT W

CONTROL PANEL

Features

- The **SE Vento Expert W** control panels are used with **Vento Expert W V.2** energy recovery single-room ventilation units.
- The control panel provides control over the basic operating modes of the units.
- The ventilators are connected to the control panel over Wi-Fi.



Design

- Casing made of high-quality plastic.
- Glass sensor operating panel with touch buttons with light indication.
- IP40 ingress protection rating.

Control panel functions

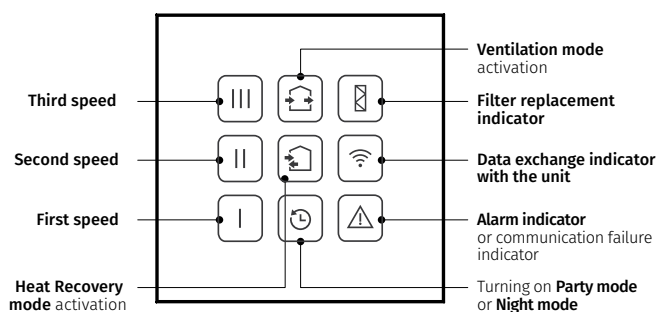

Technical data

Parameters	SE Vento Expert W
Voltage [V]	110–230/50 (60) Hz
Maximum current [A]	0.012
Cable type [mm ²]	2x0.35
Temperature range [°C]	+10...+45
Humidity range [%]	10–80 (no condensation)
Casing material	Plastic
Sensor surface material	Glass
SEC class	IP40
Weight [g]	190
Wi-Fi data	
Standard	IEEE 802.11 b/g/n
Frequency band [GHz]	2.4
Transmission power [mW] (dBm)	100 (+20)
Network	DHCP
WLAN safety	WPA, WPA2

Installation and connection

- The **SE Vento Expert W** panels can be attached to a wall surface or concealed in a wall. To enable these mounting configurations, the units are delivered with **EDR-I 1** (in-wall) and **EDR-E 5** (surface) mounting boxes.
- Connection of the control panel is carried out according to the User's manual of the unit.

Overall dimensions [mm]

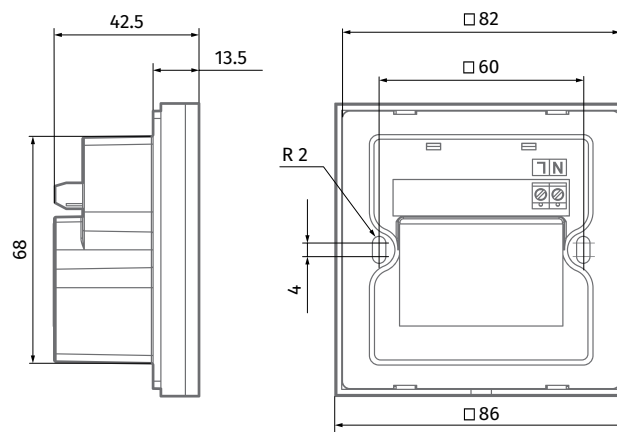

EH FRESHBOX

ELECTRIC HEATER

Features

- The electric heater maintains above-zero temperature of the condensate drain pipe of the **Freshbox 100** and **Freshbox 100 WiFi** air handling units.
- The heater is equipped with a temperature sensor for automatic activation and de-activation.



Design

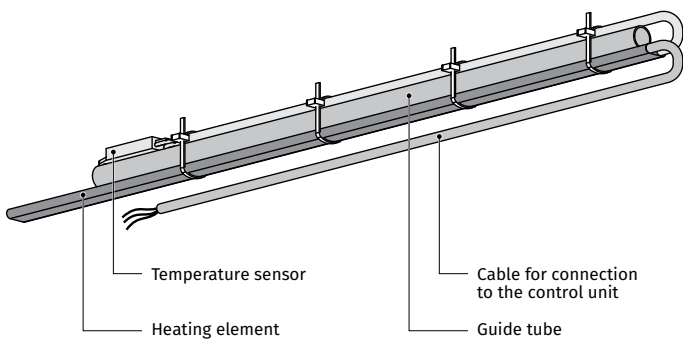

Technical data

Parameters	EH Freshbox
Power [W]	21.6 at 0 °C, 18 at 10 °C
Voltage [V]	230
Current [A]	0.1
Current protection [A]	32

Mounting

- Electric heater mounting is carried out according to the User's manual.

CD-1/CD-2

CO₂ SENSORS

Features

- Indoor carbon dioxide concentration measurement.
- Air flow control of the **Vento** and **Freshbox** ventilation units based on CO₂ levels.
- Efficient energy saving device.



Design

- The sensor has two separate outputs, a normally opened dry relay contact and an analogue output 0–10 V that is adjustable fo 2–10 V/ 0–20 mA/4–20 mA. The relay output is used to turn the fan on/off depending on indoor CO₂ concentration and the analogue output is used for smooth fan speed control for a fan with EC motor or a fan with extra speed controller with 0–10 V input. In case of smooth fan speed control the fan speed varies proportionally to carbon dioxide emissions. Due to the relay and analogue outputs the sensor is compatible with any ventilation system. The self-calibration system ensures reliable sensor operation during the sensor service life.

Modifications

- CD-1:** integrated LED lights for indication of CO₂ concentration and a touch button for operation mode switching (mode 1: on, mode 2: off, mode 3: operation according to CO₂ concentration). The button is used to turn the fan on or turn it off when CO₂-based ventilation is not required.
- CD-2:** no integrated LED-lights and no touch button. This model is recommended for premises requiring permanent ventilation as school classes and other public premises.

Mounting and power supply

- Wall surface mounting.
- 24 VAC low current power supply.
- The sensor has a socket for AT power unit offered as an accessory (AT-220/25 or AT-120/25 models).



Technical data

Parameters	Value
Power supply / Consumption	24 VAC (50/60 Hz ± 10 %), 24 VDC/1.6 W Max
Gas sensing element	Non-dispersive infrared detector (NDIR) with self-calibration system
CO ₂ -measuring range	0–2000 ppm (parts per million)
Accuracy at 25 °C, 2000 ppm	±30 ppm + 3 % of reading
Response time	max. 2 min
Warm up time for each turning-on	2 hours (first time), 2 minutes (operation)
Analogue output	0–10 VDC (default), 4–20 mA selectable by jumpers
On/Off output	1X2A switch load Four set points selectable by jumpers
6 LED lights for CO ₂ concentration indication (for CD-1 model)	1st green indicator lights when CO ₂ concentration is below 600 ppm 1st and 2nd green indicators light when CO ₂ concentration is 600–800 ppm 1st yellow indicator lights when CO ₂ concentration is 800–1200 ppm 1st and 2nd yellow indicators light when CO ₂ concentration is 1200–1400 ppm 1st red indicator lights when CO ₂ concentration is 1400–1600 ppm 1st and 2nd red indicators light when CO ₂ concentration is above 1600 ppm
Operating conditions / Storage regulations	0–50 °C; 0–95 % RH non condensing/0–50 °C
Weight/Dimensions	0.120 kg/100 mm x 80 mm x 30 mm

Sensor wiring diagram

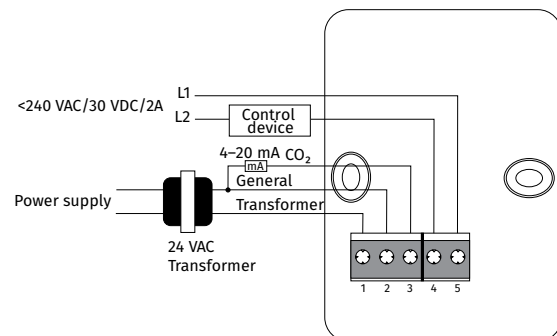

DRWQ40200

CO₂ SENSORS

Features

- Self-calibrating sensor with microprocessor control for measuring carbon dioxide content in the air within the range from 0 to 2.000 million⁻¹ (parts per million).



Design

- DRWQ40200** CO₂ sensor has 2 analogue outputs: 0–10 V and 4–20 mA. An analogue output provides for stepless fan speed control (requires an EC motor fan or a frequency drive).
- With stepless control the fan speed is changed in proportion to carbon dioxide concentration changes. The CO₂ content in the air is measured by means of a non-dispersive infrared analyser (NDIR).

Mounting

- The sensor is mounted onto a wall or a mounting box inside the serviced space. The unit is powered from a 24 VAC/VDC low-current electric mains.

Technical data

Parameters	Values
Power source	24 VAC/VDC
Gas analyser	optical (NDIR)
CO ₂ measurement range	0–2000 ppm (parts per million)
CO ₂ output signal	0–10 V
CO ₂ measurement precision	± 30 ppm (parts per million), ± 5 % of maximum value
Operating conditions	0–50 °C; 10–90 % relative humidity without condensate
Protection class	IP55
Dimensions	95x97x30 mm

DPWQ30600

VOC SENSOR

Features

- Self-calibrating processor-controlled VOC sensor provides air quality measurement.
- The device is used for quantitative assessment of indoor air saturation with contaminants (e.g. cigarette smoke, expired air, and solvent and detergent vapours).
- Enables setting the sensitivity level relative to an expected maximum air pollution level.
- Enables on-demand ventilation which results in considerable energy savings as air is exchanged only upon reaching the pre-set level of air pollution.



Design

- **DPWQ30600** VOC sensor has 2 analogue outputs: 0–10 V and 4–20 mA. An analogue output provides for stepless fan speed control (requires an EC motor fan or a frequency drive).
- With stepless control the fan speed is changed in proportion to air quality changes.

Mounting

- The sensor is mounted onto a wall or a mounting box inside the serviced space. The unit is powered from a 24 VAC/VDC low-current electric mains.

Technical data

Parameters	Values
Power source	24 VAC/VDC
Gas analyser	VOC sensor
Measurement range	0–100 % air quality
Output signal	0–10 V
Measurement precision	±20 %
Operating conditions	0–50 °C; 10–90 % relative humidity without condensate
Protection class	IP30
Dimensions	79x81x26 mm

DPWC11200

HUMIDITY AND TEMPERATURE SENSOR

Features

- The sensor is intended for temperature, humidification and/or dehumidification control in ventilation, air conditioning and heating systems.
- The sensor is compatible with the majority of other standard controllers.



Design

- The **DPWC11200** humidity and temperature sensor has 2 analogue outputs: 0–10 V and 4–20 mA. An analogue output provides for stepless fan speed control (requires an EC motor fan).
- With stepless control the fan speed is changed in proportion to the humidity and temperature level. Being equipped with both relay and analogue outputs the sensor is compatible with most every existing ventilation systems.

Mounting

- The sensor is mounted onto a wall in the serviced space. The unit is powered from a 24 VAC/VDC low-current electric mains.

Technical data

Parameters	Values
Power source	8–30 VDC / 12–24 VAC
Analogue outputs	0–10 V and 4–20 mA
Temperature measurement precision	±1.2 °C
Humidity measurement precision	±3 % RH
Operating conditions	-10–60 °C; 10–90 % humidity without condensate
Protection class	IP30
Dimensions	127x80x30 mm

HR-S

ELECTRO-MECHANICAL HUMIDISTAT

Features

- The humidistat is designed for controlling humidification and/or dehumidification in ventilation, air conditioning and heating systems.
- Can also be used to alarm when the humidity exceeds or falls below a pre-set level.



Design

- The single-stage humidistat HR-S uses a synthetic element as sensor medium. The synthetic element stretches as the humidity increases and shrinks as the humidity decreases.

Mounting

- The humidistat is designed for indoor mounting on the wall surface.

Humidistat wiring diagram

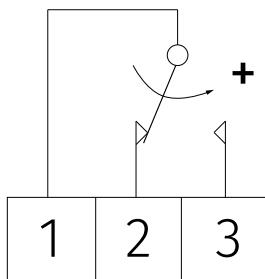

Humidification
Dehumidification

Closing contact between terminals 1 and 2
Closing contact between terminals 1 and 3

Technical data

Parameters	HR-S
Switch contact	250 VAC, 5 A
Humidity	20-90 %
Casing material	Polycarbonate
Temperature range [°C]	0-40
Mounting	Wall surface mounting
Ingress protection	IP30
Dimensions	86x86x30 mm

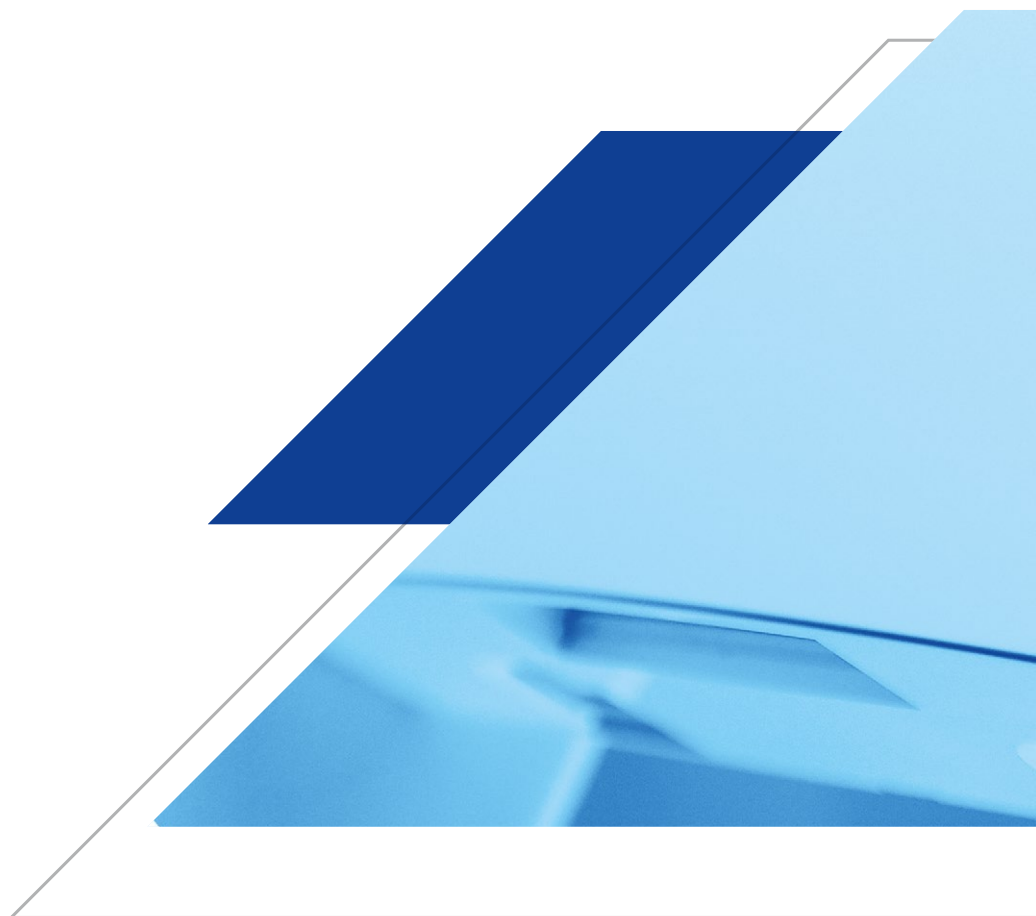

Blauberg Ventilatoren GmbH
Aidenbachstr. 52
D-81379 Munich

info@blaubergventilatoren.de
www.blaubergventilatoren.de

Technical changes reserved.
Illustrations and texts are non-binding.

05/2022