

# SINGLE-ROOM VENTILATION

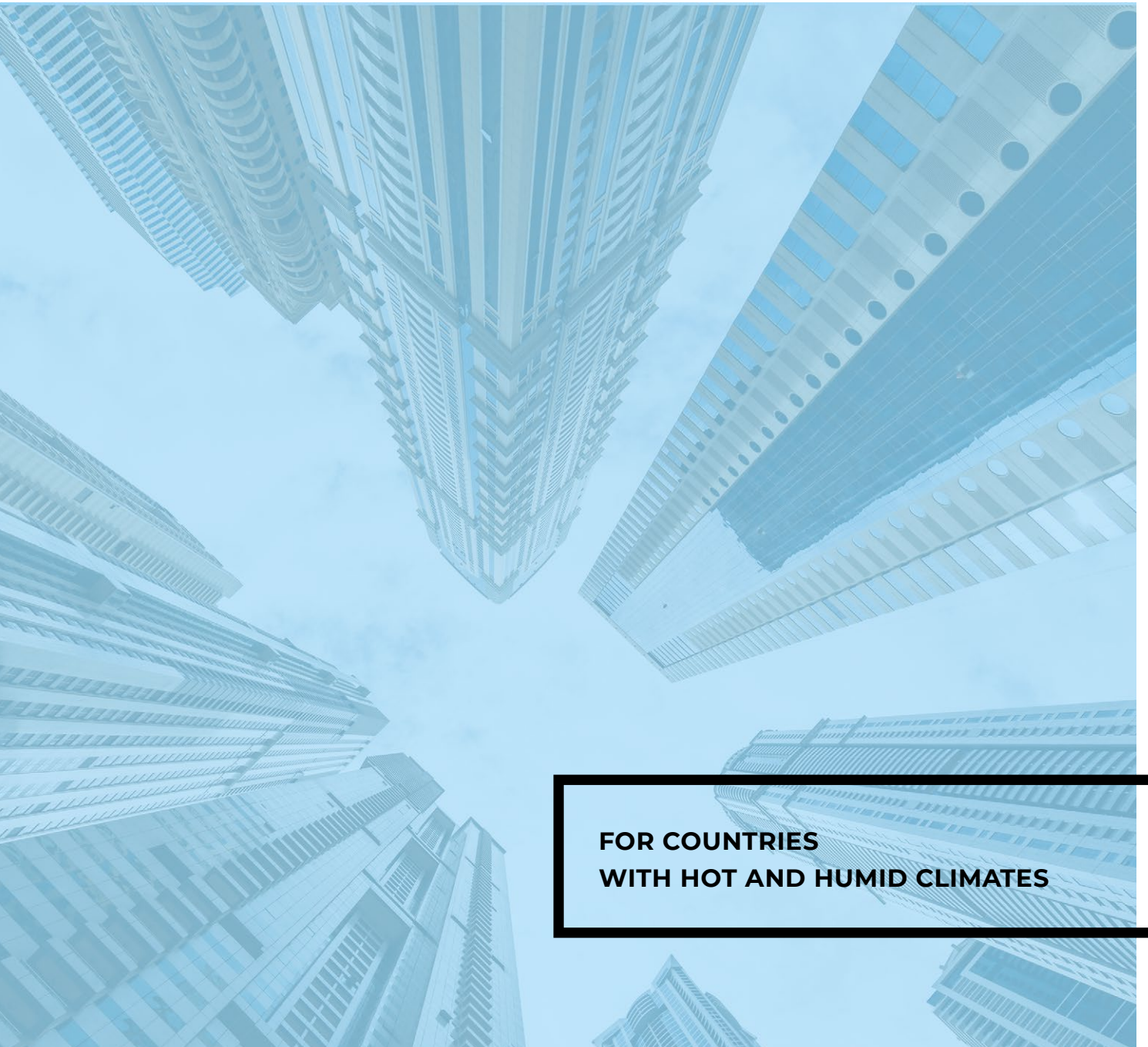

**FOR COUNTRIES  
WITH HOT AND HUMID CLIMATES**

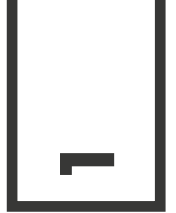

**2**  
ABOUT  
BLAUBERG  
GROUP

**8**  
INTRODUCTION  
INTO  
SINGLE-ROOM  
VENTILATION

**12**  
  
CIVIC EC LB V.2

**22**  
  
CIVIC EC DB V.2

**32**  
  
FRESHBOX  
100 ERV

**38**  
  
FRESHBOX  
100 ERV WI-FI

**44**  
  
FRESHBOX  
110 ERV

**50**  
  
FRESHBOX  
200 ERV WI-FI

**56**  
  
HYBRID MAX  
ERV

**64**  
  
VENTO ERGO  
A50(85)-1 PRO V.3

**70**  
  
VENTO EXPERT  
A30 S10 W V.2

**76**  
  
VENTO EXPERT  
A50(85)-1  
C1 W V.3

**84**  
  
VENTO EXPERT  
A50(85)-1  
C1 S10 PRO

**92**  
  
SOLO S4  
PRO R V.2

**96**  
  
VENTO ECO  
A50-4 S11 PRO

# CONTENTS

## ABOUT US

The **Blauberg Group** is an international group of companies offering complete ventilation and refrigeration solutions.

We are a full-service company developing, manufacturing and supplying the widest possible range of products.

### **Blauberg Group**



### **Our products**

The Group's companies produce a full range of ventilation products, from domestic fans and air distribution units to high-tech air handling units, single-room and industrial units with heat recovery and modern automation.

Our products combine innovative technologies, modern design, and comply with the international standards for energy efficiency, reliability and safety.

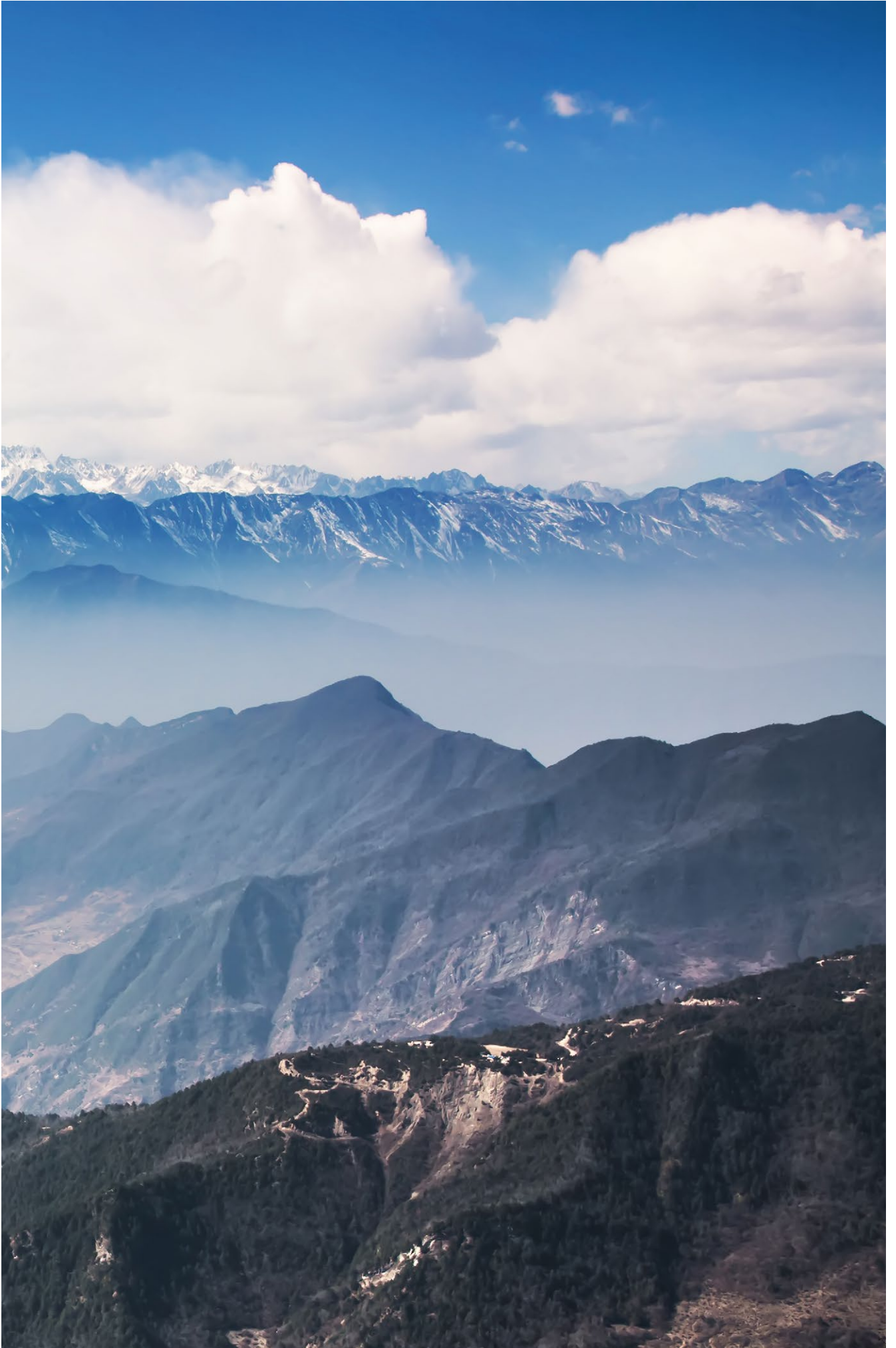

## WHY US?



### Expertise

Over 300 engineers and technicians with expertise in cutting-edge technology provide innovative leadership, product quality and reliability.



### Sustainable development

We create energy efficient ventilation products in environmentally responsible ways striving to leave a minimal footprint by using sustainable raw materials, efficient equipment and by optimizing processes.



### Quality

When purchasing the products of the group, our customers can rely on the performance, safety and environmental compatibility, which is confirmed by numerous tests and certificates.



### Innovation

Our R&D centre specialists in different countries explore and implement advanced technologies and engineering solutions based on international experience, the latest global trends and market needs.

# Blauberg Group worldwide



○ Blauberg Group  
offices

● Blauberg Group  
production facilities

Representative and partner offices of the Blauberg Group are located in different countries and continents in order to guarantee timely deliveries and service to our customers.

More than 3 500 highly qualified specialists work in the production area of more than 210 000 square metres to produce modern ventilation products represented in more than 120 countries worldwide.

#### PRODUCTION SITES

- Germany
- China
- Ukraine
- Hungary
- Poland

8

production  
facilities

14

representative  
offices

123

countries  
worldwide

## Production

The Blauberg Group considers investment in up-to-date machinery, innovations and materials from leading global manufacturers to be one of the decisive success factors in the technology sector.

Annual increases in production rates and line renewals enable optimising product costs and offering the market modern, reliable, energy-efficient, safe solutions that meet the highest quality standards.

## Equipment



## Raw materials



**210 000 m<sup>2</sup>**  
of production areas

**20**  
extrusion lines

**>1400**  
injection moulds

**>100**  
metal working machines  
for complex shapes

**130**  
injection moulding machines

# Quality and expertise

All products in the Group comply with the international quality standards. Control is carried out at all stages of product manufacture, from design to production processes and quality control of finished products. This is confirmed by certificates and audits from international organisations.

# QUALITY

## Audits



## Membership



## Certificates







# What is in the air we breathe?

Breathing clean fresh air is essential for maintaining your health. Overpopulated cities, congested roads, fuming pipes of factories and plants, never-ending development and agricultural activities all have their adverse effects on the air environment. According to the research conducted by the World

Health Organisation, the pollution of the air environment and indoor air is a major contributor to the morbidity and mortality around the world. Today 91% of the world population live in cities and have to deal with skyrocketing pollution. The most deleterious effects on the human health are attributed to nitrogen

dioxide, harmful particulate matter and elevated ozone concentrations. Buildings under construction and renovation projects may also generate air pollution. A large-scale research of cases related to poor indoor air quality helped to identify the key factors which adversely affect our breathing environment:

## 50 %

### Inefficient ventilation

Inadequate supply of fresh air or poor ducting efficiency.

## 30 %

### Indoor pollutants

The presence of premises-specific pollutants (e.g. formaldehyde, solvent vapours, dust, and microbiological pollution).

## 10 %

### Outdoor pollutants

Pollutants originating from external sources (e.g. vehicle exhaust fumes, pollen, fungal spores, smoke, and dust resulting from roadworks and construction work).

## 10 %

### Other factors

Out-of-range temperature and relative humidity which cause occupant discomfort.

### The typical signs of excessively high humidity are:

- Heavy levels of condensation on the inside of window panes
- Damp stains on ceilings and/or walls
- Wallpaper bubbling and coming off the wall
- Drawers and doors sticking
- Mould and resulting physical discomfort

# Why do we need ventilation?



## Fresh air

The basic purpose of ventilation is to supply clean fresh air into the room.



## Balancing the pressure

Ventilation must be properly balanced. Low indoor pressure in the absence of supply units equipped with filters causes dirty outdoor air to seep in through various cracks and openings – moreover, if the walls and windows are air-tight, it will find its way in through the sewerage system if it isn't properly sealed.



## A comfortable breathing environment

Extract fans remove cold stale air from the building and while wet warm air enters the premises through cracks and leaks in window panes and door assemblies causing a degradation in the indoor air quality and increase a humidity level.

Buildings should be tight – but they should still be able to breathe.

It means that buildings should be tight so that we do not use too much energy on cooling or heating and that they should be able to breathe in order for humid and 'used' air to escape. Buildings should not breathe through random holes, but through controlled and on-demand ventilation.

Not all buildings have a good indoor climate. This is often because the building contains too much humidity. This can cause both health-related and financial problems. For the building this can mean rot and mould in the structure which can give us asthma and allergies if

they are allowed to develop. More and more people are diagnosed with asthma and allergies. Part of the explanation is a poor indoor climate. The air is damp. Your eyes are dry and irritated. Your head seems heavy and you have difficulties concentrating. A poor indoor climate has a big impact on our ability to function and well-being in our daily life.

Surveys show that a poor indoor climate negatively impacts our performance levels by 5-10%. For children this impact is even greater. That is why we need ventilation.



# Ways to organise ventilation in a premise

## CENTRALISED ventilation systems

A single unit is responsible for exchanging the air in all the rooms of a house or a flat.

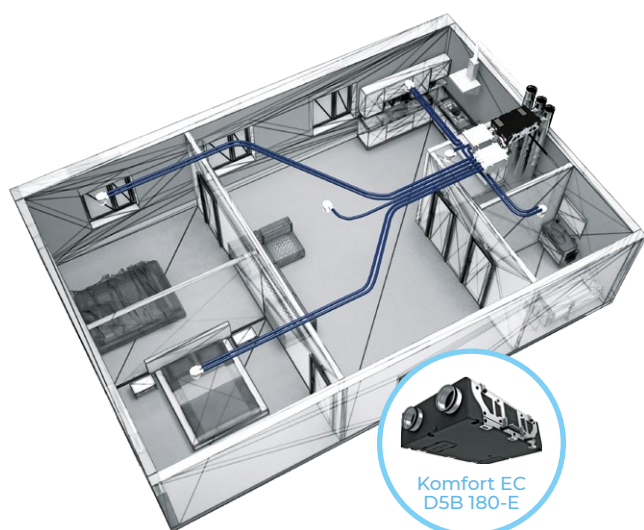

### Features

- This unit supplies fresh air which is cleaned by the built-in filters and extracts stale air from the room.
- A single air handling unit is capable of providing efficient ventilation for the entire home.
- The unit requires a system of air ducts.
- The ventilation modes are selected automatically by the built-in control system.
- Heat energy recovery helps save energy.
- The ventilation system design must prevent air leaks from the spaces filled with stale air into those with fresh air.
- A properly designed system is essential for ensuring an intensive air exchange essential to the occupant comfort.
- The ventilation system operating modes are adjusted from a single point for all the spaces in the home.

## SINGLE-ROOM ventilation systems

Air supply and extraction are carried out by a separate ventilation unit in each room.

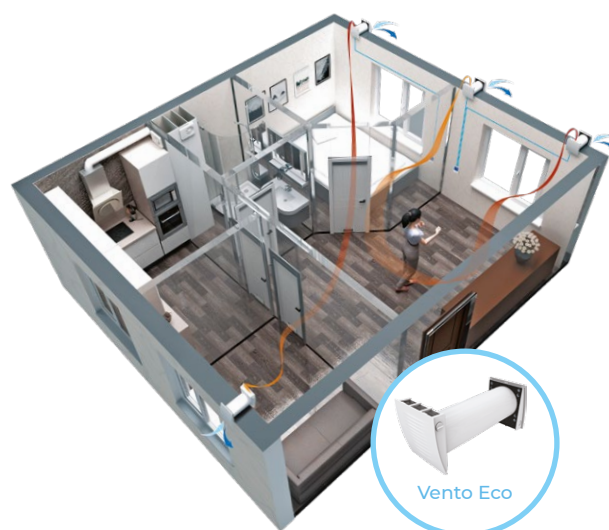

### Features

- Fresh air intake, filtration and stale air exhaust to outside.
- Compact ventilators do not require any additional elements or ducts, they are ready for use and designed for direct wall mounting in the outer walls of buildings.
- An individual air flow adjustment is possible for each room of a house or an apartment.
- It is necessary to determine only the performance of the unit at design phase, which significantly simplifies the calculations.
- Low fan power due to direct air discharge contributes to low-noise operation.
- Heat recovery and humidity balance in the premises are achieved through the use of heat exchangers.
- Reduce heating costs in winter and air conditioning costs in summer.

## SINGLE-ROOM ventilation system arrangement

Single-room ventilation system is the most modern and practical solution for creating a comfortable breathing environment and necessary air exchange in reconstructed premises, new and newly settled houses or in residential renovated apartments.

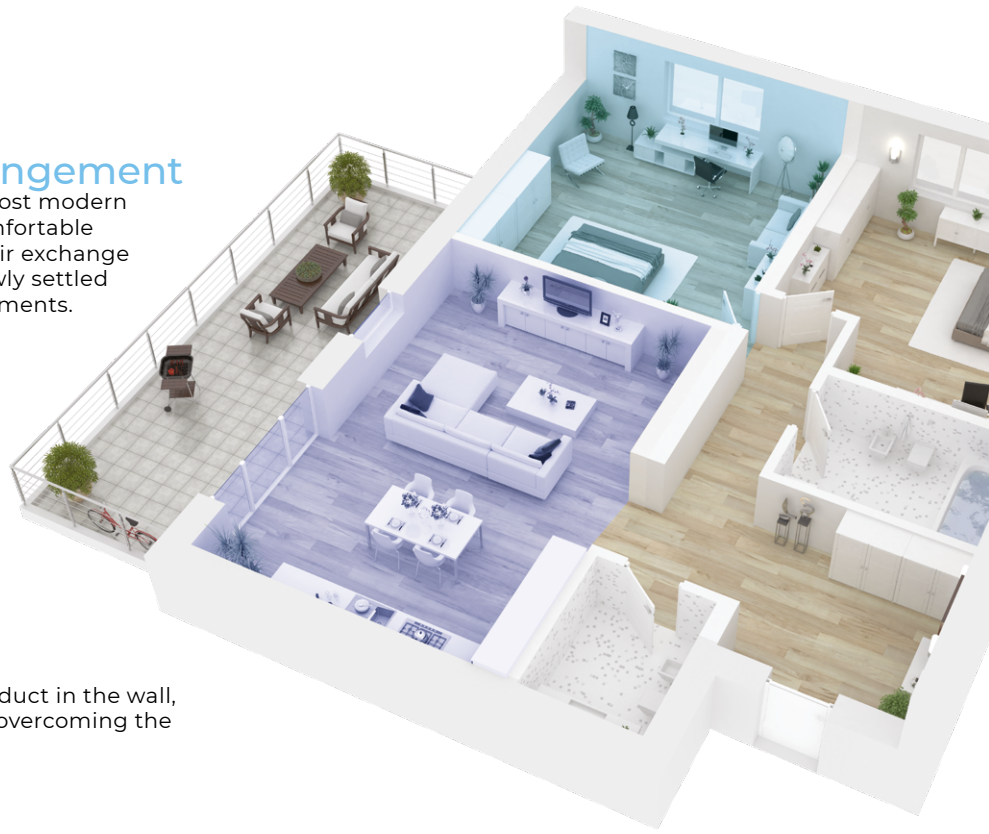

Single-room ventilation improves fire safety due to the absence of air ducts between individual spaces.

Fresh air is supplied through a short air duct in the wall, and the unit does not spend energy on overcoming the resistance of long ducts.

### Units with a plate heat exchanger (Freshbox, CIVIC)

- Ensure comfortable breathing environment in a particular room.
- Each space is ventilated on demand.
- Unit speed is set automatically to ensure the proper air quality.
- Direct mounting into the wall.
- Mounting into thin walls without reducing efficiency.
- Simple design makes it fit into any interior.

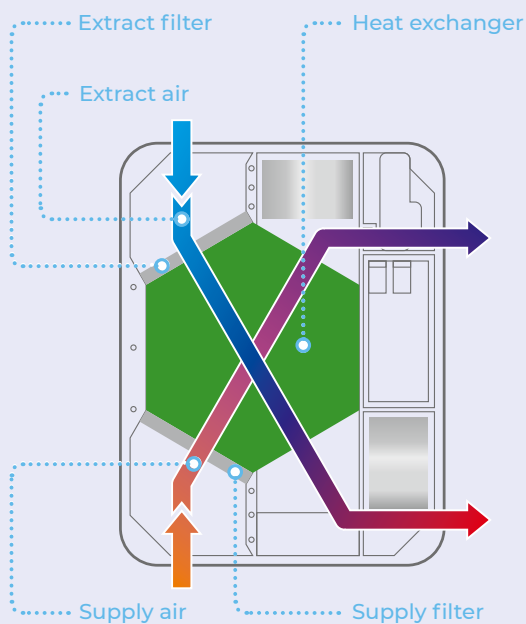

### Units with a ceramic heat exchanger (Vento Expert)

- Ensure a comfortable breathing environment in a particular room.
- Balanced ventilation when even number of units is installed.
- The unit is mounted directly into the wall.
- High efficiency.
- Moisture recovery and no condensate formed.
- Low noise level.
- Suitable for mounting into thin walls without reducing efficiency.
- May be equipped with filters with high filtration efficiency.
- Minimum indoor unit size and easy maintenance.
- May be equipped with an external hood for air outlet to the window aperture, which allows retaining appearance of the facade.

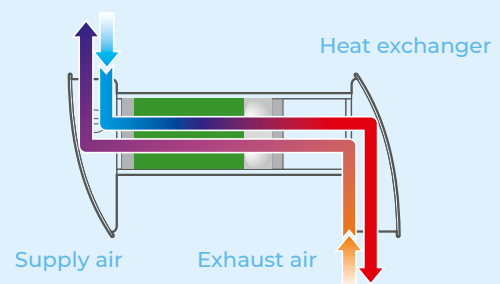



# CIVIC EC LB V.2

## DECENTRALIZED SUPPLY AND EXHAUST UNIT WITH HEAT RECOVERY



1240 m<sup>3</sup>/h



from 21 dBA



up to 89 %



## FEATURES

The **CIVIC EC LB V.2** units are designed for singleroom ventilation of schools, offices and other public and commercial premises. Offer the ideal simple and efficient ventilation solutions for existing and renovated buildings and require no layout of air ducts.

Efficient supply and extract ventilation for separate premises.

EC motors with low energy consumption.

Low-noise operation.

Simple mounting.

Air ducts can be taken out through the windows.

## Designation key

Model	Motor type	Mounting	Bypass	Heater	Drain pump	Rated air flow [m <sup>3</sup> /h]	Heat exchanger type	Service side (for Civic... 1200)	Control	Modernization
<b>CIVIC</b>	<b>EC:</b> synchronous electronically commutated motor	<b>L:</b> floor mounting	<b>B:</b> with bypass	<b>_:</b> without heater <b>E:</b> preheating <b>E2:</b> preheating + reheating	<b>_:</b> without drain pump <b>CP:</b> with drain pump	300; 500; 1200	<b>_:</b> heat recovery <b>-E:</b> energy recovery	<b>L:</b> Left <b>R:</b> Right	S21	<b>V.2:</b> second modernized generation

## Design

Made of high-quality polymer coated steel, internally lined with heat- and sound insulation of mineral wool, cellular synthetic rubber or other materials.

Built-in preheater and reheater modifications available for cold climate conditions.

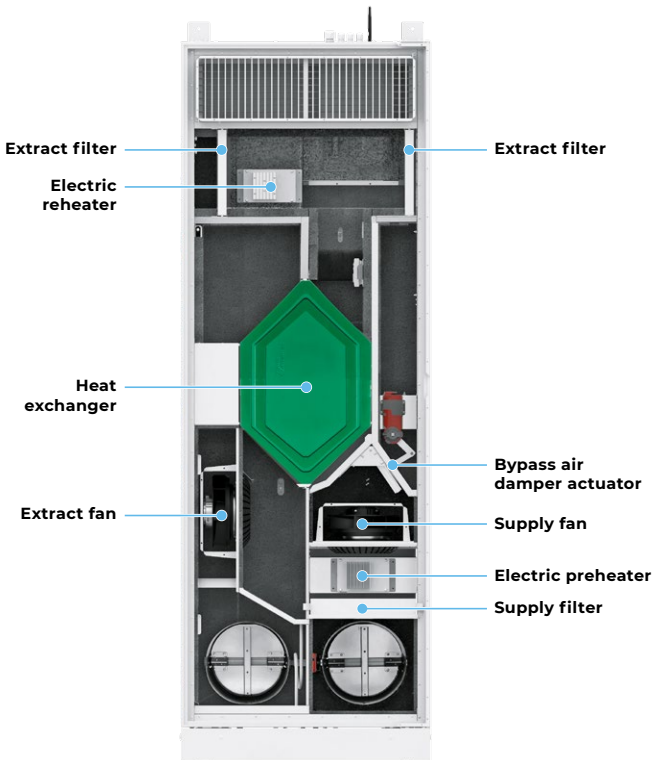

## Motors

High efficient electronically commutated motors with external motor and impeller with forward curved blades. Such motors are the most state-of-the-art energy saving solution.

EC motors are featured with high performance and total speed controllable range. High efficiency reaching 90 % is the premium advantage of the electronically commutated motors.

## Air filtration

Exhaust cassette filter: ISO Coarse >60 % (G4).

Supply cassette filter: ISO ePM1 60 % (F7)

## Bypass

The units are equipped with a bypass. The bypass damper opens for free cooling ventilation mode in summer.

## Air dampers

The automatic supply and extract air dampers are used to prevent uncontrollable air draughts during the unit standstill.

## Heaters

### PREHEATING

**CIVIC EC LBE V.2** and **CIVIC EC LBE2 V.2** units are equipped with an electric preheater which protects the heat exchanger from freezing.

### REHEATING

**CIVIC EC LBE2 V.2** units feature an electric reheater to raise the supply air temperature.

## Heat exchanger

The **CIVIC EC LB... -E V.2** unit is equipped with a counter-flow heat exchanger made of enthalpy membrane.

- In cold season the heat and moisture of the extract air are absorbed by supply air through the enthalpy membrane, thus decreasing the heat losses caused by ventilation.
- In warm season the heat and humidity of the outdoor air is absorbed by extract air flow through the enthalpy membrane. This way the supply air temperature and humidity decreases and heat recovery reduces operation loads for the air conditioner.

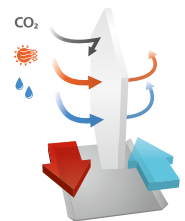

## Functioning

Warm Cold and humid outside air flows through the filters and heat exchanger and is moved to the room with a supply centrifugal fan.

Cooled polluted air from the premise flows through the filter and the heat exchanger and is exhausted outside with an extract centrifugal fan through an air duct in the wall.



## Mounting example







Air ducts can be taken out through the windows

## Control and automation



The **CIVIC EC LB... S21 V.2** units are equipped with an integrated automation system.

The S21 controller allows integrating the unit into the **BMS (Building Management System)**.

The unit can be controlled by the Blauberg Home mobile application via Wi-Fi.

 <p>Download the Blauberg Home app for Android</p>	 <p>Download the Blauberg Home app for iOS</p>	 
---	---	---

## Automation functions

Functions	Description
Unit control via Wi-Fi using the mobile application	+
Unit control via remote control panel	 S22 control panel (option)
Unit control via remote wireless control panel	 S22 Wi-Fi control panel (option)
Unit control via a wired remote LCD control panel	 S25 control panel (option)
BMS (Building Management System)	RS-485
	Wi-Fi
	Ethernet
	MODBUS (RTU, TCP)
Speed switch	+
Filter replacement indication	by filter timer
Alarm indication	full alarm description in the mobile application
Week scheduled operation	+
Bypass	automatic
	manual
Timer	+
Boost mode	+
Fireplace mode	+
Freeze protection	using cyclical stops of the supply fan
	using preheating (option)
Reheater connection	option
Minimum supply air temperature control	+
CO <sub>2</sub> control	option
VOC control	option
PM2.5 control	option
Fire alarm sensor connection	option

Option: the functionality is available when purchasing the appropriate accessory (see the "Accessories" section)



## Technical data

Parameters	Civic EC LB 300-E S21 V.2	Civic EC LBE 300-E S21 V.2	Civic EC LBE2 300-E S21 V.2
Voltage [V / 50 (60) Hz]	1~230	1~230	1~230
Max. power consumption without an electric heater [W]	96	96	96
Preheater power [W]	–	1050	1050
Reheater power [W]	–	–	700
Max. current without an electric heater [A]	0.75	0.75	0.75
Max. current with an electric heater [A]	–	7	11
Maximum air flow [m <sup>3</sup> /h (l/s)]	320 (89)	320 (89)	320 (89)
Sound pressure level at 1 m [dBA]	47	47	47
Sound pressure level at 3 m [dBA]	37	37	37
Max. transported air temperature [°C]	–25...+40	–25...+40	–25...+40
Casing material	polymer coated steel	polymer coated steel	polymer coated steel
Insulation	40 mm, mineral wool	40 mm, mineral wool	40 mm, mineral wool
Extract filter	ISO Coarse >60 % (G4)	ISO Coarse >60 % (G4)	ISO Coarse >60 % (G4)
Supply filter	ISO ePM1 60 % (F7)	ISO ePM1 60 % (F7)	ISO ePM1 60 % (F7)
Connected air duct diameter [mm]	200	200	200
Weight [kg]	100	101	103
Temperature exchange efficiency (heating) [%]	80...89	80...89	80...89
Temperature exchange efficiency (cooling) [%]	70...85	70...85	70...85
Enthalpy exchange efficiency (heating) [%]	72...82	72...82	72...82
Enthalpy exchange efficiency (cooling) [%]	70...80	70...80	70...80
Heat exchanger type	counter-flow	counter-flow	counter-flow
Heat exchanger material	enthalpic membrane	enthalpic membrane	enthalpic membrane

Sound-power level, A - weighted	Total	Octave frequency band [Hz]																		LpA 3 m	LpA 1 m
		200	250	315	400	500	630	800	1000	1250	1600	2000	2500	3150	4000	5000	6300	8000	10000		
LwA to environment @ point 1 [dBA]	58	46	50	48	44	49	48	43	46	46	47	48	45	39	32	27	24	26	25	37	47
LwA to environment @ point 5 [dBA]	49	29	39	34	40	41	39	35	38	38	39	39	35	28	22	20	20	23	24	29	38
LwA to environment @ point 9 [dBA]	42	30	33	31	29	36	32	26	31	30	30	30	26	21	19	19	19	23	24	22	31
LwA to environment @ point 3 [dBA]	58	46	50	47	44	49	48	44	46	46	47	47	44	39	33	28	24	25	25	37	47
LwA to environment @ point 4 [dBA]	58	46	50	48	45	50	48	43	46	46	47	48	45	39	32	27	23	25	25	38	47

Point	Total power of the unit [W]	Total sound pressure level at 3 m (1 m) [dBA]
1	92	37 (47)
2	91	–
3	85	37 (47)
4	75	38 (47)
5	40	29 (38)
6	38	–

Point	Total power of the unit [W]	Total sound pressure level at 3 m (1 m) [dBA]
7	35	–
8	32	–
9	19	22 (31)
10	18	–
11	17	–

Parameters	Civic EC LB 500-E S21 V.2	Civic EC LBE 500-E S21 V.2	Civic EC LBE2 500-E S21 V.2
<b>Voltage [V / 50 (60) Hz]</b>	1~230	1~230	1~230
<b>Max. power consumption without an electric heater [W]</b>	370	370	370
<b>Preheater power [W]</b>	–	1050	1050
<b>Reheater power [W]</b>	–	–	700
<b>Max. current without an electric heater [A]</b>	2.5	2.5	2.5
<b>Max. current with an electric heater [A]</b>	–	9.1	13.3
<b>Maximum air flow [m³/h (l/s)]</b>	580 (161)	580 (161)	580 (161)
<b>Sound pressure level at 1 m [dBA]</b>	47	47	47
<b>Sound pressure level at 3 m [dBA]</b>	38	38	38
<b>Max. transported air temperature [°C]</b>	–25...+40	–25...+40	–25...+40
<b>Casing material</b>	polymer coated steel	polymer coated steel	polymer coated steel
<b>Insulation</b>	40 mm, mineral wool	40 mm, mineral wool	40 mm, mineral wool
<b>Extract filter</b>	ISO Coarse >60 % (G4)	ISO Coarse >60 % (G4)	ISO Coarse >60 % (G4)
<b>Supply filter</b>	ISO ePM1 60 % (F7)	ISO ePM1 60 % (F7)	ISO ePM1 60 % (F7)
<b>Connected air duct diameter [mm]</b>	250	250	250
<b>Weight [kg]</b>	139	140	142
<b>Temperature exchange efficiency (heating) [%]</b>	70...82	70...82	70...82
<b>Temperature exchange efficiency (cooling) [%]</b>	69...80	69...80	69...80
<b>Enthalpy exchange efficiency (heating) [%]</b>	70...78	70...78	70...78
<b>Enthalpy exchange efficiency (cooling) [%]</b>	67...75	67...75	67...75
<b>Heat exchanger type</b>	counter-flow	counter-flow	counter-flow
<b>Heat exchanger material</b>	enthalpic membrane	enthalpic membrane	enthalpic membrane

Sound-power level, A - weighted	Total	Octave frequency band [Hz]																	LpA 3 m	LpA 1 m	
		200	250	315	400	500	630	800	1000	1250	1600	2000	2500	3150	4000	5000	6300	8000			10000
LWA to environment @ point 1 [dBA]	57	47	52	51	48	47	44	45	45	44	46	48	45	38	30	27	25	26	27	38	47
LWA to environment @ point 5 [dBA]	49	44	37	36	42	38	38	37	38	37	39	41	37	29	24	23	22	25	26	28	39
LWA to environment @ point 9 [dBA]	37	28	27	26	31	29	28	28	29	27	27	28	25	21	20	21	22	25	27	17	27
LWA to environment @ point 3 [dBA]	55	47	46	42	47	46	43	43	43	43	43	45	42	35	29	27	24	26	27	35	45
LWA to environment @ point 4 [dBA]	47	49	48	49	52	51	50	50	49	48	46	46	44	38	33	30	27	28	28	28	37

Point	Total power of the unit [W]	Total sound pressure level at 3 m (1 m) [dBA]
<b>1</b>	236	37 (47)
<b>2</b>	236	–
<b>3</b>	234	35 (45)
<b>4</b>	234	28 (37)
<b>5</b>	80	28 (39)
<b>6</b>	78	–

Point	Total power of the unit [W]	Total sound pressure level at 3 m (1 m) [dBA]
<b>7</b>	76	–
<b>8</b>	75	–
<b>9</b>	21	17 (27)
<b>10</b>	19	–
<b>11</b>	20	–

Parameters	Civic EC LB 1200-E S21 V.2	Civic EC LBE 1200-E S21 V.2	Civic EC LBE2 1200-E S21 V.2
<b>Voltage [V / 50 (60) Hz]</b>	1~230	3~400	3~400
<b>Max. power consumption without an electric heater [W]</b>	345	345	345
<b>Preheater power [W]</b>	-	3150	3150
<b>Reheater power [W]</b>	-	-	2110
<b>Max. current without an electric heater [A]</b>	2.3	2.3	2.3
<b>Max. current with an electric heater [A]</b>	-	12	18.7
<b>Maximum air flow [m<sup>3</sup>/h (l/s)]</b>	1240 (344)	1240 (344)	1240 (344)
<b>Sound pressure level at 1 m [dBA]</b>	40	40	40
<b>Sound pressure level at 3 m [dBA]</b>	30	30	30
<b>Max. transported air temperature [°C]</b>	-25...+40	-25...+40	-25...+40
<b>Casing material</b>	polymer coated steel	polymer coated steel	polymer coated steel
<b>Insulation</b>	40 mm, mineral wool	40 mm, mineral wool	40 mm, mineral wool
<b>Extract filter</b>	ISO Coarse >60 % (G4)	ISO Coarse >60 % (G4)	ISO Coarse >60 % (G4)
<b>Supply filter</b>	ISO ePM1 60 % (F7)	ISO ePM1 60 % (F7)	ISO ePM1 60 % (F7)
<b>Connected air duct diameter [mm]</b>	400	400	400
<b>Weight [kg]</b>	352	358	363
<b>Temperature exchange efficiency (heating) [%]</b>	70...83	70...83	70...83
<b>Temperature exchange efficiency (cooling) [%]</b>	68...81	68...81	68...81
<b>Enthalpy exchange efficiency (heating) [%]</b>	66...80	66...80	66...80
<b>Enthalpy exchange efficiency (cooling) [%]</b>	65...80	65...80	65...80
<b>Heat exchanger type</b>	counter-flow	counter-flow	counter-flow
<b>Heat exchanger material</b>	enthalpic membrane	enthalpic membrane	enthalpic membrane

Sound-power level, A - weighted	Total	Octave frequency band [Hz]								LpA 3 m	LpA 1 m
		63	125	250	500	1000	2000	4000	8000		
LwA to environment @ point 1 [dBA]	50	31	35	40	37	36	36	28	17	30	40
LwA to environment @ point 5 [dBA]	47	27	31	33	29	30	27	22	13	26	36
LwA to environment @ point 9 [dBA]	32	21	27	21	25	17	19	24	16	11	21

Point	Total power of the unit [W]	Total sound pressure level at 3 m (1 m) [dBA]
1	315	30 (40)
2	312	-
3	311	30 (40)
4	308	26 (36)
5	122	15 (25)
6	121	-

Point	Total power of the unit [W]	Total sound pressure level at 3 m (1 m) [dBA]
7	120	-
8	118	-
9	24	11 (21)
10	23	-
11	22	-

**CIVIC EC LB/LBE/LBE2 300-E V.2**

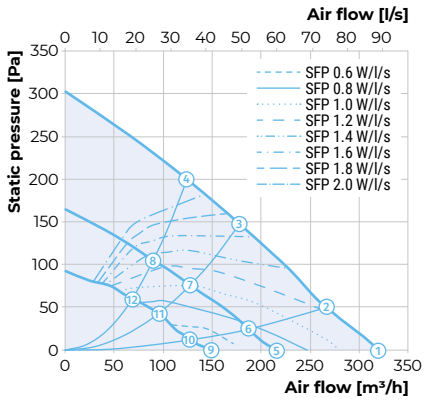

**CIVIC EC LB/LBE/LBE2 500-E V.2**

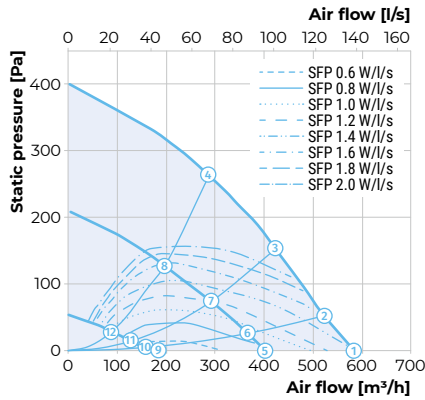

**CIVIC EC LB/LBE/LBE2 1200-E V.2**

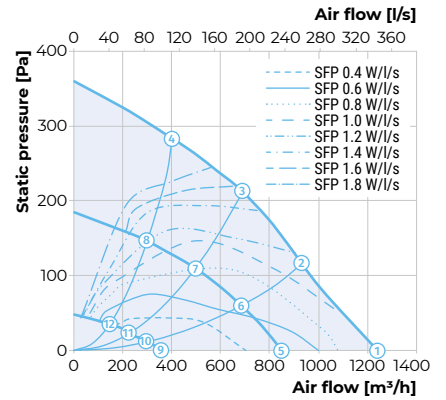

**Fresh air flow distance for CIVIC EC LB 300-E V.2**

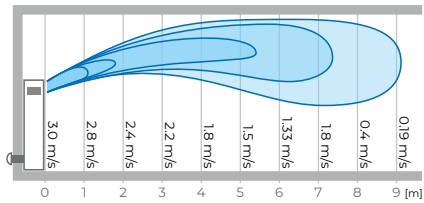

**Fresh air flow distance for CIVIC EC LB 500-E V.2**

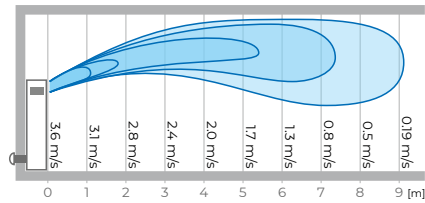

**Fresh air flow distance for CIVIC EC LB 1200-E V.2**

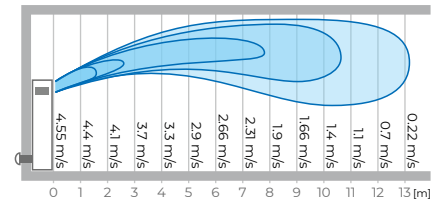

The unit is rated for indoor application with the ambient temperature ranging from +1 °C to +40 °C and relative humidity up to 80%

**Overall dimensions [mm]**

Model	Ø D	H	H1	H2	H3	H4	L	L1	W	W1	W2
CIVIC EC LB 300-E V.2	200	1775	1485	285	-	-	470	520	620	310	155
CIVIC EC LB 500-E V.2	250	2170	1865	305	-	-	535	585	750	350	200
CIVIC EC LB 1200-E V.2	400	2000	2106	545	1110	70	535	265	1900	1951	-

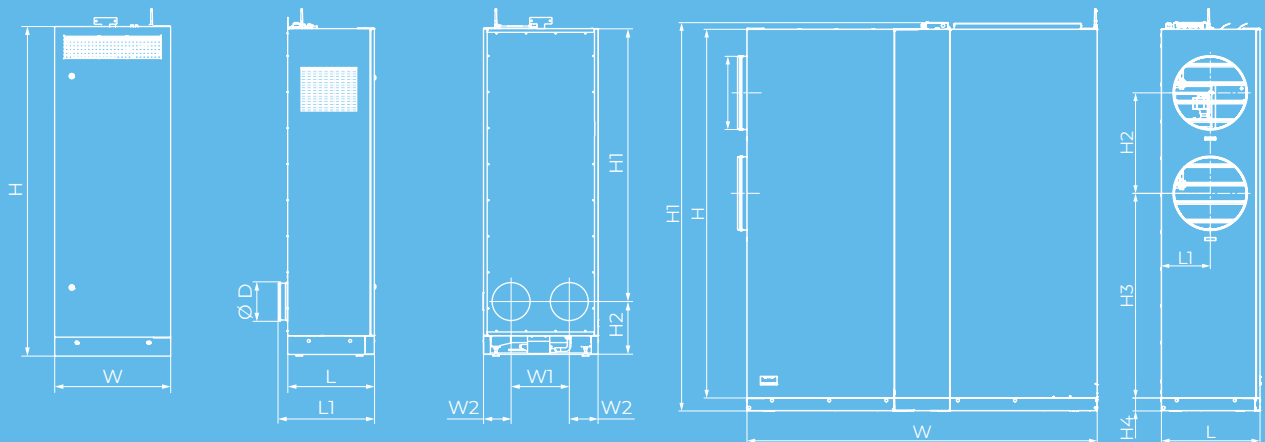

CIVIC EC LB 300-E V.2 / CIVIC EC LB 500-E V.2

CIVIC EC LB 1200 V.2

## Accessories

		Civic EC LB... 300-E S21 V.2	Civic EC LB... 500-E S21 V.2	Civic EC LB... 1200-E S21 V.2
<b>Outer ventilation hood made of brushed stainless steel</b>		AH Civic 300 LB chrome	AH Civic 500 LB chrome	AH Civic 1200 LB chrome
<b>Outer ventilation hood made of white coated stainless steel</b>		AH Civic 300 LB white	AH Civic 500 LB white	AH Civic 1200 LB white
<b>Extract filter ISO Coarse &gt;60 % (G4)</b>		FP 203x308x20 G4 (2 pcs.)	FP 255x448x25 G4 (2 pcs.)	FP 450x395x48 G4
<b>Supply filter ISO ePM1 60 % (F7)</b>		FP 384x273x60 F7	FP 449x318x60 F7	FP 540x450x48 F7
<b>Control panel</b>		S22	S22	S22
<b>Wi-Fi control panel</b>		S22 Wi-Fi	S22 Wi-Fi	S22 Wi-Fi
<b>LCD Control panel</b>		S25	S25	S25
<b>VOC sensor</b>		DPWQ30600	DPWQ30600	DPWQ30600
<b>CO<sub>2</sub> sensor</b>		DPWQ40200	DPWQ40200	DPWQ40200
<b>CO<sub>2</sub> sensor with indication</b>		CD-1	CD-1	CD-1
<b>CO<sub>2</sub> sensor</b>		CD-2	CD-2	CD-2

		Civic EC LB... 300-E S21 V.2	Civic EC LB... 500-E S21 V.2	Civic EC LB... 1200-E S21 V.2
<b>CO<sub>2</sub> sensor</b>		CD-3	CD-3	CD-3
<b>Syphon kit</b>		SFK 20x32	SFK 20x32	SFK 20x32
<b>Drain pump</b>		CP-2	CP-2	CP-2



# CIVIC EC DB V.2

## DECENTRALIZED SUPPLY AND EXHAUST UNIT WITH HEAT RECOVERY



## FEATURES

The **CIVIC EC DB V.2** units are designed for single-room ventilation of schools, offices and other public and commercial premises. Offer the ideal simple and efficient ventilation solutions for existing and renovated buildings and require no layout of air ducts.

Efficient supply and extract ventilation for separate premises.

EC motors with low energy consumption.

Low-noise operation.

Simple mounting.

Air ducts can be taken out through the windows.

## Designation key

Model	Motor type	Mounting	Bypass	Heater	Drain pump*	Rated air flow [m³/h]	Heat exchanger type	Control	Modernization
<b>CIVIC</b>	<b>EC:</b> synchronous electronically commutated motor	<b>D:</b> Suspended mounting, horizontally oriented spigots; <b>D1:</b> Suspended mounting, vertically oriented spigots	<b>B:</b> with bypass	<b>_:</b> without heater <b>E:</b> preheating <b>E2:</b> preheating + reheating	<b>_:</b> without drain pump <b>CP:</b> with drain pump	300; 500; 1000	<b>_:</b> heat recovery <b>-E:</b> energy recovery	S21	<b>V.2:</b> second modernized generation

\* The CIVIC EC DB... 1000 S21 V.2 units are equipped with a drain pump by default.



## Design

Made of high-quality polymer coated steel, internally lined with heat- and sound insulation of mineral wool, cellular synthetic rubber or other materials.

Available modifications with an integrated preheater and reheater for cold climate applications.

## Motors

High efficient electronically commutated motors with external motor and impeller with forward curved blades. Such motors are the most state-of-the-art energy saving solution.

EC motors are featured with high performance and total speed controllable range. High efficiency reaching 90% is the premium advantage of the electronically commutated motors.

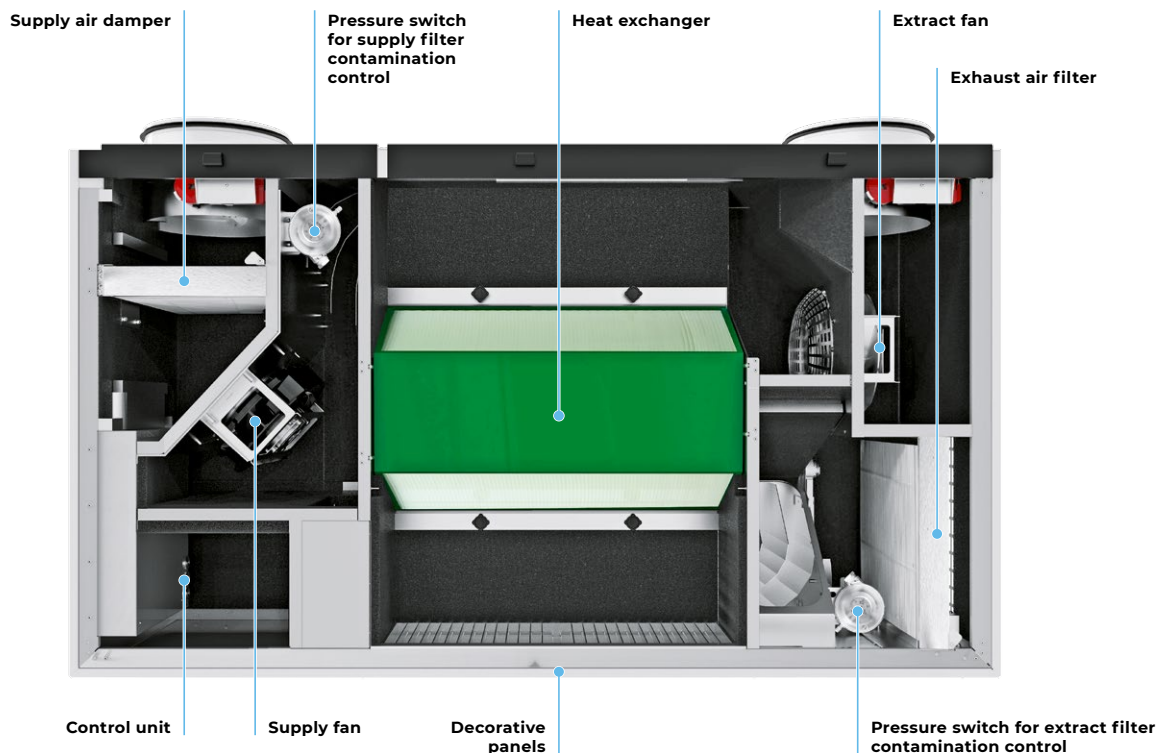

## Air filtration

Exhaust cassette filter: ISO Coarse >60 % (G4).

Supply cassette filter: ISO ePM1 60 % (F7)

## Bypass

The units are equipped with a bypass. The bypass damper opens for free cooling ventilation mode in summer.

## Air dampers

The automatic supply and extract air dampers are used to prevent uncontrollable air draughts during the unit standstill.

## Heater

### PREHEATING

**CIVIC EC DBE V.2** and **CIVIC EC DBE2 V.2** units are equipped with an electric preheater which protects the heat exchanger from freezing.

### REHEATING

**CIVIC EC DBE2 V.2** units feature an electric reheater to raise the supply air temperature.

## Heat exchanger

The **CIVICECDB...-EV.2** unit is equipped with a counter-flow heat exchanger made of enthalpy membrane.

- In cold season the heat and moisture of the extract air are absorbed by supply air through the enthalpy membrane, thus decreasing the heat losses caused by ventilation.
- In warm season the heat and humidity of the outdoor air is absorbed by extract air flow through the enthalpy membrane. This way the supply air temperature and humidity decreases and heat recovery reduces operation loads for the air conditioner.

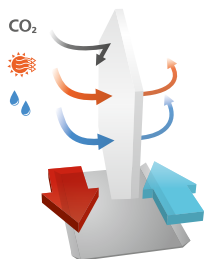

## Functioning

**Cold outside air** flows through the filters and heat exchanger and is moved to the room with a supply centrifugal fan.

**Warm polluted air from the premise** flows through the filter and the heat exchanger and is exhausted outside with an extract centrifugal fan through an air duct in the wall.

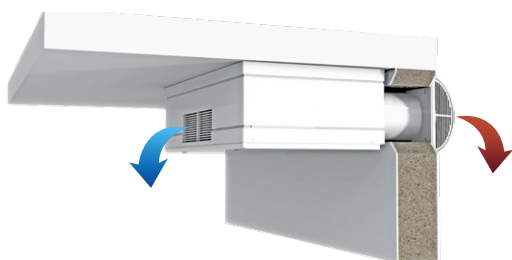

## Control and automation



The **CIVIC EC DB S21 V.2** units are equipped with an integrated automation system.

The S21 controller allows integrating the unit into the **BMS (Building Management System)**.

The unit can be controlled by the Blauberg Home mobile application via Wi-Fi.

<p>Download the Blauberg Home app for Android</p>	<p>Download the Blauberg Home app for iOS</p>	

## Automation functions

Functions	Description
Unit control via Wi-Fi using the mobile application	+
Unit control via remote control panel	 S22 control panel (option)
Unit control via remote wireless control panel	 S22 Wi-Fi control panel (option)
Unit control via a wired remote LCD control panel	 S25 control panel (option)
BMS (Building Management System)	RS-485
	Wi-Fi
	Ethernet
	MODBUS (RTU, TCP)
Speed switch	+
Filter replacement indication	by filter timer
Alarm indication	full alarm description in the mobile application
Week scheduled operation	+
Bypass	automatic
	manual
Timer	+
Boost mode	+
Fireplace mode	+
Freeze protection	using cyclical stops of the supply fan
	using preheating (option)
Reheater connection	option
Minimum supply air temperature control	+
Humidity control	option
CO <sub>2</sub> control	option
VOC control	option
PM2.5 control	option
Fire alarm sensor connection	option

Option: the functionality is available when purchasing the appropriate accessory (see the "Accessories" section)

## Technical data

Parameters	CIVIC EC DB 300-E S21 V.2	CIVIC EC DBE 300-E S21 V.2	CIVIC EC DBE2 300-E S21 V.2
Voltage [V / 50 (60) Hz]	1~ 230	1~ 230	1~ 230
Max. power consumption without an electric heater [W]	204	204	204
Preheater power [W]	–	1050	1050
Reheater power [W]	–	–	700
Max. current without an electric heater [A]	1.5	1.5	1.5
Max. current with an electric heater [A]	–	7.7	11.7
Maximum air flow [m <sup>3</sup> /h (l/s)]	300 (83)	300 (83)	300 (83)
Sound pressure level at 1 m [dBA]	44	44	44
Sound pressure level at 3 m [dBA]	34	34	34
Max. transported air temperature [°C]	–25...+40	–25...+40	–25...+40
Casing material	polymer coated steel	polymer coated steel	polymer coated steel
Insulation	25 mm, EPDM (polyurethane foam)	25 mm, EPDM (polyurethane foam)	25 mm, EPDM (polyurethane foam)
Extract filter	ISO Coarse >60 % (G4)	ISO Coarse >60 % (G4)	ISO Coarse >60 % (G4)
Supply filter	ISO ePM1 60 % (F7)	ISO ePM1 60 % (F7)	ISO ePM1 60 % (F7)
Connected air duct diameter [mm]	200	200	200
Weight [kg]	78	79	80
Temperature exchange efficiency (heating) [%]	80...89	80...89	80...89
Temperature exchange efficiency (cooling) [%]	70...85	70...85	70...85
Enthalpy exchange efficiency (heating) [%]	72...82	72...82	72...82
Enthalpy exchange efficiency (cooling) [%]	70...80	70...80	70...80
Heat exchanger type	counter-flow	counter-flow	counter-flow
Heat exchanger material	enthalpic membrane	enthalpic membrane	enthalpic membrane

Sound-power level, A - weighted	Total	Octave frequency band [Hz]																		LpA 3 m	LpA 1 m
		200	250	315	400	500	630	800	1000	1250	1600	2000	2500	3150	4000	5000	6300	8000	10000		
LwA to environment @ point 1 [dBA]	54.9	45.3	47.5	47.8	41.0	46.2	42.0	40.1	40.3	40.7	40.8	43.5	42.3	35.2	27.4	23.8	21.6	24.6	24.6	43.9	34.4
LwA to environment @ point 5 [dBA]	48.2	46.3	35.4	33.2	35.5	33.9	31.5	31.1	31.2	32.6	33.1	34.1	30.7	23.4	19.6	19.3	19.7	23.3	24.4	37.3	27.7
LwA to environment @ point 9 [dBA]	37.2	29.3	29.7	26.0	27.4	26.6	24.3	23.2	23.0	22.6	21.3	22.3	20.0	18.2	18.0	18.5	19.3	23.0	24.3	26.2	16.6
LwA to environment @ point 3 [dBA]	55.3	46.5	49.5	49.9	40.5	43.2	39.9	38.2	39.1	40.0	39.9	42.3	41.4	34.6	27.2	24.0	21.7	24.6	24.4	44.4	34.8
LwA to environment @ point 4 [dBA]	55.1	45.2	50.0	48.6	40.7	43.2	40.3	38.6	39.1	40.3	40.1	42.5	41.5	34.8	27.2	24.0	21.7	24.8	24.6	44.1	34.5

Point	Total power of the unit [W]	Total sound pressure level at 3 m (1 m) [dBA]
1	125	34 (44)
2	116	34 (44)
3	104	–
4	86	35 (44)
5	48	28 (38)
6	44	–

Point	Total power of the unit [W]	Total sound pressure level at 3 m (1 m) [dBA]
7	42	–
8	36	–
9	17	17 (26)
10	17	–
11	16	–
12	16	–

Parameters	CIVIC EC DB 500-E S21 V.2	CIVIC EC DBE 500-E S21 V.2	CIVIC EC DBE2 500-E S21 V.2
Voltage [V / 50 (60) Hz]	1~ 230	1~ 230	1~ 230
Max. power consumption without an electric heater [W]	238	238	238
Preheater power [W]	–	1050	1050
Reheater power [W]	–	–	700
Max. current without an electric heater [A]	1.7	1.7	1.7
Max. current with an electric heater [A]	–	9.3	12.6
Maximum air flow [m <sup>3</sup> /h (l/s)]	510 (142)	510 (142)	510 (142)
Sound pressure level at 1 m [dBA]	44	44	44
Sound pressure level at 3 m [dBA]	34	34	34
Max. transported air temperature [°C]	–25...+40	–25...+40	–25...+40
Casing material	polymer coated steel	polymer coated steel	polymer coated steel
Insulation	25 mm, EPDM (polyurethane foam)	25 mm, EPDM (polyurethane foam)	25 mm, EPDM (polyurethane foam)
Extract filter	ISO Coarse >60 % (G4)	ISO Coarse >60 % (G4)	ISO Coarse >60 % (G4)
Supply filter	ISO ePM1 60 % (F7)	ISO ePM1 60 % (F7)	ISO ePM1 60 % (F7)
Connected air duct diameter [mm]	250	250	250
Weight [kg]	95	95	96
Temperature exchange efficiency (heating) [%]	70...82	70...82	70...82
Temperature exchange efficiency (cooling) [%]	69...80	69...80	69...80
Enthalpy exchange efficiency (heating) [%]	70...78	70...78	70...78
Enthalpy exchange efficiency (cooling) [%]	67...75	67...75	67...75
Heat exchanger type	counter-flow	counter-flow	counter-flow
Heat exchanger material	enthalpic membrane	enthalpic membrane	enthalpic membrane

Sound-power level, A - weighted	Total	Octave frequency band [Hz]																LpA 3 m	LpA 1 m		
		200	250	315	400	500	630	800	1000	1250	1600	2000	2500	3150	4000	5000	6300			8000	10000
LWA to environment @ point 1 [dBA]	54.7	44.7	48.8	46.3	45.7	41.3	38.8	40.9	40.4	40.2	42.8	43.0	40.0	32.8	27.7	25.7	23.6	25.9	25.8	43.7	34.1
LWA to environment @ point 5 [dBA]	48.2	44.7	37.8	37.3	38.6	32.7	31.5	32.8	33.0	32.8	35.3	35.1	31.2	23.8	20.7	20.2	19.8	23.2	24.2	37.2	27.7
LWA to environment @ point 9 [dBA]	33.6	22.9	21.9	27.0	24.3	17.8	17.1	17.6	16.9	16.4	17.2	17.6	17.1	17.5	17.8	18.7	19.5	23.0	24.1	22.6	13.0
LWA to environment @ point 3 [dBA]	61.2	55.0	53.5	53.5	52.1	46.5	45.2	46.1	46.1	45.6	46.8	45.9	43.9	39.1	36.4	47.1	40.1	39.9	35.2	50.2	40.7
LWA to environment @ point 4 [dBA]	55.4	47.7	47.7	47.2	46.4	42.0	39.4	40.7	41.3	41.2	43.8	44.0	41.5	33.8	29.0	26.8	23.9	25.2	24.9	44.4	34.8

Point	Total power of the unit [W]	Total sound pressure level at 3 m (1 m) [dBA]
1	170	34 (44)
2	153	–
3	135	34 (44)
4	116	35 (44)
5	95	28 (37)
6	86	–

Point	Total power of the unit [W]	Total sound pressure level at 3 m (1 m) [dBA]
7	80	–
8	68	–
9	25	17 (26)
10	24	–
11	24	–
12	22	–

Parameters	CIVIC EC DB 1000-E S21 V.2	CIVIC EC DBE 1000-E S21 V.2	CIVIC EC DBE2 1000-E S21 V.2
<b>Voltage [V / 50 (60) Hz]</b>	1~ 230	3~400	3~400
<b>Max. power consumption without an electric heater [W]</b>	267	267	267
<b>Preheater power [W]</b>	–	3150	3150
<b>Reheater power [W]</b>	–	–	2100
<b>Max. current without an electric heater [A]</b>	1.85	1.85	1.85
<b>Max. current with an electric heater [A]</b>	–	12	18
<b>Maximum air flow [m<sup>3</sup>/h (l/s)]</b>	1000 (278)	1000 (278)	1000 (278)
<b>Sound pressure level at 1 m [dBA]</b>	34	34	34
<b>Sound pressure level at 3 m [dBA]</b>	24	24	24
<b>Max. transported air temperature [°C]</b>	–25...+40	–25...+40	–25...+40
<b>Casing material</b>	polymer coated steel	polymer coated steel	polymer coated steel
<b>Insulation</b>	45 mm, EPDM (polyurethane foam)	45 mm, EPDM (polyurethane foam)	45 mm, EPDM (polyurethane foam)
<b>Extract filter</b>	ISO Coarse >60 % (G4)	ISO Coarse >60 % (G4)	ISO Coarse >60 % (G4)
<b>Supply filter</b>	ISO ePM1 60 % (F7)	ISO ePM1 60 % (F7)	ISO ePM1 60 % (F7)
<b>Connected air duct diameter [mm]</b>	315	315	315
<b>Weight [kg]</b>	252	258	268
<b>Temperature exchange efficiency (heating) [%]</b>	70...83	70...83	70...83
<b>Temperature exchange efficiency (cooling) [%]</b>	68...81	68...81	68...81
<b>Enthalpy exchange efficiency (heating) [%]</b>	66...80	66...80	66...80
<b>Enthalpy exchange efficiency (cooling) [%]</b>	65...80	65...80	65...80
<b>Heat exchanger type</b>	counter–flow	counter–flow	counter–flow
<b>Heat exchanger material</b>	enthalpic membrane	enthalpic membrane	enthalpic membrane

Sound-power level, A - weighted	Total	Octave frequency band [Hz]								LpA 3 m	LpA 1 m
		63	125	250	500	1000	2000	4000	8000		
LwA to environment @ point 1 [dBA]	45	31	37	40	37	36	36	29	18	24	34
LwA to environment @ point 5 [dBA]	37	26	29	32	29	29	29	24	15	17	27
LwA to environment @ point 9 [dBA]	32	21	26	20	25	19	20	25	18	11	21

Point	Total power of the unit [W]	Total sound pressure level at 3 m (1 m) [dBA]
<b>1</b>	260	24 (34)
<b>2</b>	251	23 (33)
<b>3</b>	235	23 (33)
<b>4</b>	221	22 (32)
<b>5</b>	136	17 (27)
<b>6</b>	130	17 (27)

Point	Total power of the unit [W]	Total sound pressure level at 3 m (1 m) [dBA]
<b>7</b>	125	16 (27)
<b>8</b>	120	16 (27)
<b>9</b>	47	11 (21)
<b>10</b>	45	11 (21)
<b>11</b>	44	11 (21)
<b>12</b>	42	11 (21)

**CIVIC EC DB/DBE/DBE2 300-E V.2**

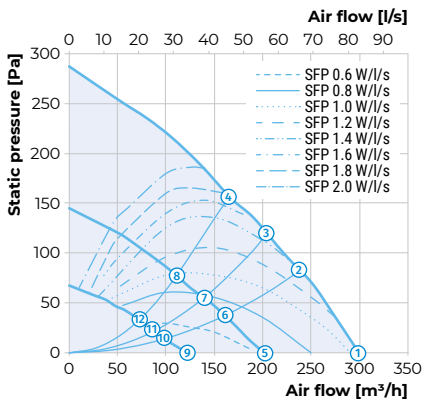

**CIVIC EC DB/DBE/DBE2 500-E V.2**

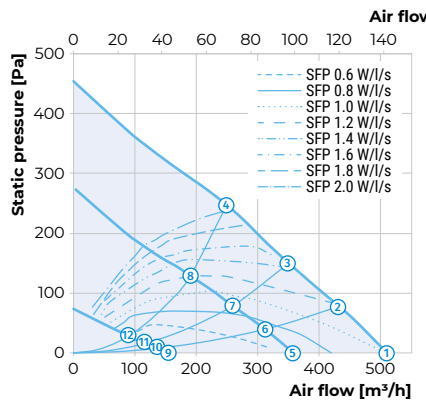

**CIVIC EC DB/DBE/DBE2 1000-E V.2**

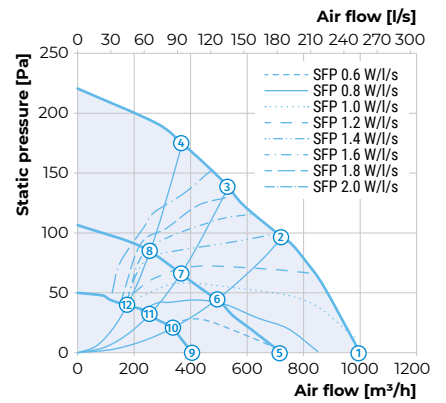

**Fresh air flow distance for CIVIC EC DB 300-E V.2**

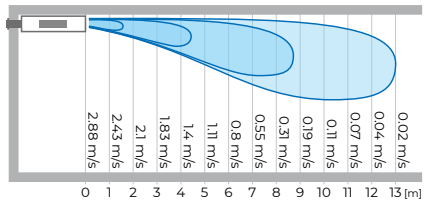

**Fresh air flow distance for CIVIC EC DB 500-E V.2**

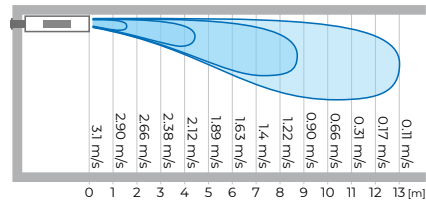

**Fresh air flow distance for CIVIC EC DB 1000-E V.2**

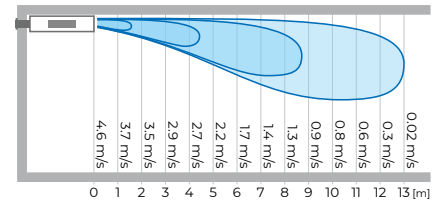

The unit is rated for indoor application with the ambient temperature ranging from +1 °C to +40 °C and relative humidity up to 80%

## Overall dimensions [mm]

Model	Ø D	H	H1	H2	L	L1	L2	L3	L4	W	W1	W2	W3
CIVIC EC DB... 300-E S21 V.2	200	402	202	41	1200	867	166	1122	445	850	181	530	207
CIVIC EC D1B... 300-E S21 V.2	200	402	450	45	1200	764	218	1122	445	1139	181	530	281
CIVIC EC DB... 500-E S21 V.2	250	458	221	41	1500	1135	186	1422	504	850	181	530	207
CIVIC EC D1B... 500-E S21 V.2	250	458	509	45	1500	964	268	1422	504	1186	181	530	304

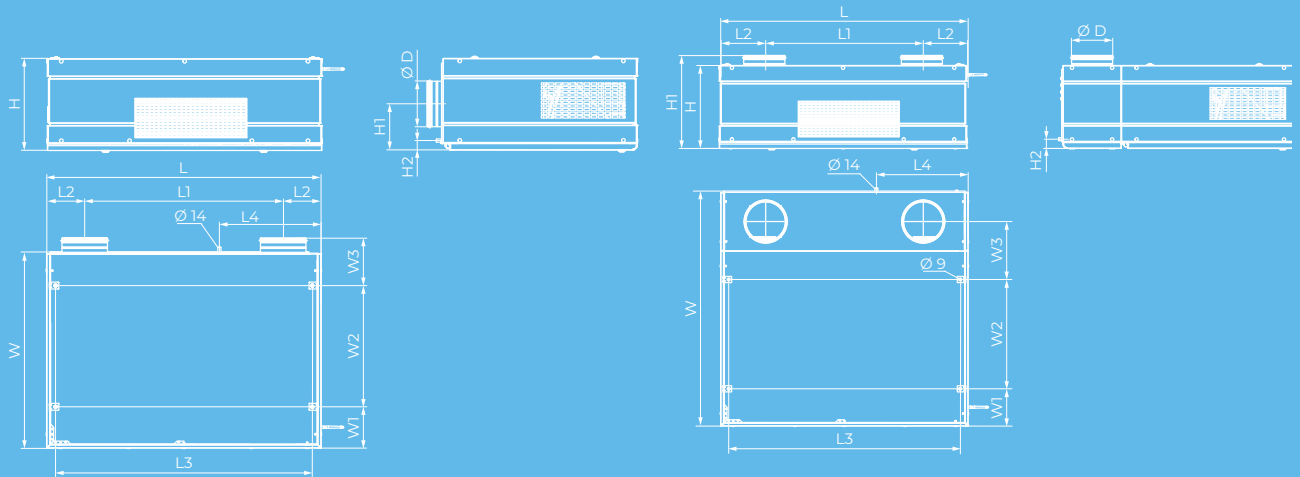

CIVIC EC DB 300-E S21 V.2 / CIVIC EC DB 500-E S21 V.2

CIVIC EC D1B 300-E S21 V.2 / CIVIC EC D1B 500-E S21 V.2

## Overall dimensions [mm]

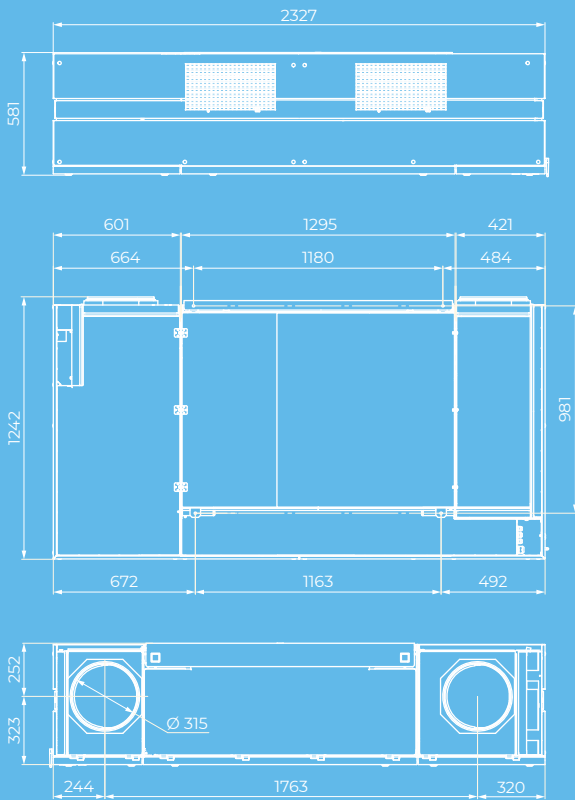



CIVIC EC DB 1000-E S21 V.2

## Mounting example



Air ducts can be taken out through the windows

## Accessories

		CIVIC EC DB 300-E S21 V.2 CIVIC EC DBE 300-E S21 V.2 CIVIC EC DBE2 300-E S21 V.2	CIVIC EC DB 500-E S21 V.2 CIVIC EC DBE 500-E S21 V.2 CIVIC EC DBE2 500-E S21 V.2	CIVIC EC DB 1000-E S21 V.2 CIVIC EC DBE 1000-E S21 V.2 CIVIC EC DBE2 1000-E S21 V.2
<b>Extract filter</b> ISO Coarse >60 % (G4)		FP 320x373x48 G4	FP 379x334x48 G4	FP 654x480x48 G4
<b>Supply filter</b> ISO ePM1 60 % (F7)		FP 320x211x48 F7	FP 379x254x48 F7	FP 654x480x48 F7
<b>Outer grill</b>		VDA 200 CFn Al	VDA 250 CFn Al	VDA 315 CFn Al
<b>Control panel</b>		S22	S22	S22

		CIVIC EC DB 300-E S21 V.2 CIVIC EC DBE 300-E S21 V.2 CIVIC EC DBE2 300-E S21 V.2	CIVIC EC DB 500-E S21 V.2 CIVIC EC DBE 500-E S21 V.2 CIVIC EC DBE2 500-E S21 V.2	CIVIC EC DB 1000-E S21 V.2 CIVIC EC DBE 1000-E S21 V.2 CIVIC EC DBE2 1000-E S21 V.2
<b>Wi-Fi control panel</b>		S22 Wi-Fi	S22 Wi-Fi	S22 Wi-Fi
<b>LCD Control panel</b>		S25	S25	S25
<b>VOC sensor</b>		DPWQ30600	DPWQ30600	DPWQ30600
<b>CO<sub>2</sub> sensor</b>		DPWQ40200	DPWQ40200	DPWQ40200
<b>CO<sub>2</sub> sensor with indication</b>		CD-1	CD-1	CD-1
<b>CO<sub>2</sub> sensor</b>		CD-2	CD-2	CD-2
<b>CO<sub>2</sub> sensor</b>		CD-3	CD-3	CD-3
<b>Humidity sensor</b>		DPWC11200	DPWC11200	DPWC11200
<b>Internal humidity sensor</b>		FS2	FS2	FS2
<b>Humidity sensor</b>		HR-S	HR-S	HR-S
<b>Syphon kit</b>		SFK 20x32	SFK 20x32	SFK 20x32
<b>Drain pump</b>		CP-2	CP-2	CP-2
<b>Modul of vertical duct connection</b>		VDC Civic 300 DB	VDC Civic 500 DB	VDC Civic 1000 DB





# FRESHBOX 100 ERV

## DECENTRALIZED SUPPLY AND EXHAUST UNIT WITH HEAT RECOVERY



100 m<sup>3</sup>/h



from 13 dBA



up to 98 %



## FEATURES

Efficient solution for supply and exhaust ventilation of enclosed spaces.

Units with enthalpy heat exchangers are available for use in hot and wet climates.

Low-energy EC motors.

Supply air purification ensured by two built-in G4 and F8 filters (optionally F8 C and H13).

Silent operation.

Upgradeable with an exhaust duct to provide air extraction from the bathroom.

Easy installation.

Compact size.

Air ducts can be taken out through the windows.

## Design

Polymer coated metal casing decorated with an acrylic front panel. Heat and noise insulation is ensured by a layer of 10 mm cellular synthetic rubber.

The front panel provides convenient access for filter maintenance and has a lock for extra security.

The unit has two Ø 100 mm pipes for fresh air intake and stale air extraction outside. The third Ø 100 mm pipe (included in the scope of delivery) can be additionally fitted to the unit to connect the exhaust air duct from the bathroom.

## Motors

The units feature efficient electronically commutated (EC) motors with an external rotor and impellers with forward curved blades. These state-of-the-art motors are the most advanced solution in energy efficiency today.

EC motors are characterised with high performance and optimum control across the entire speed range. In addition to that the efficiency of electronically commutated motors reaches very impressive levels of up to 90 %.

## Design

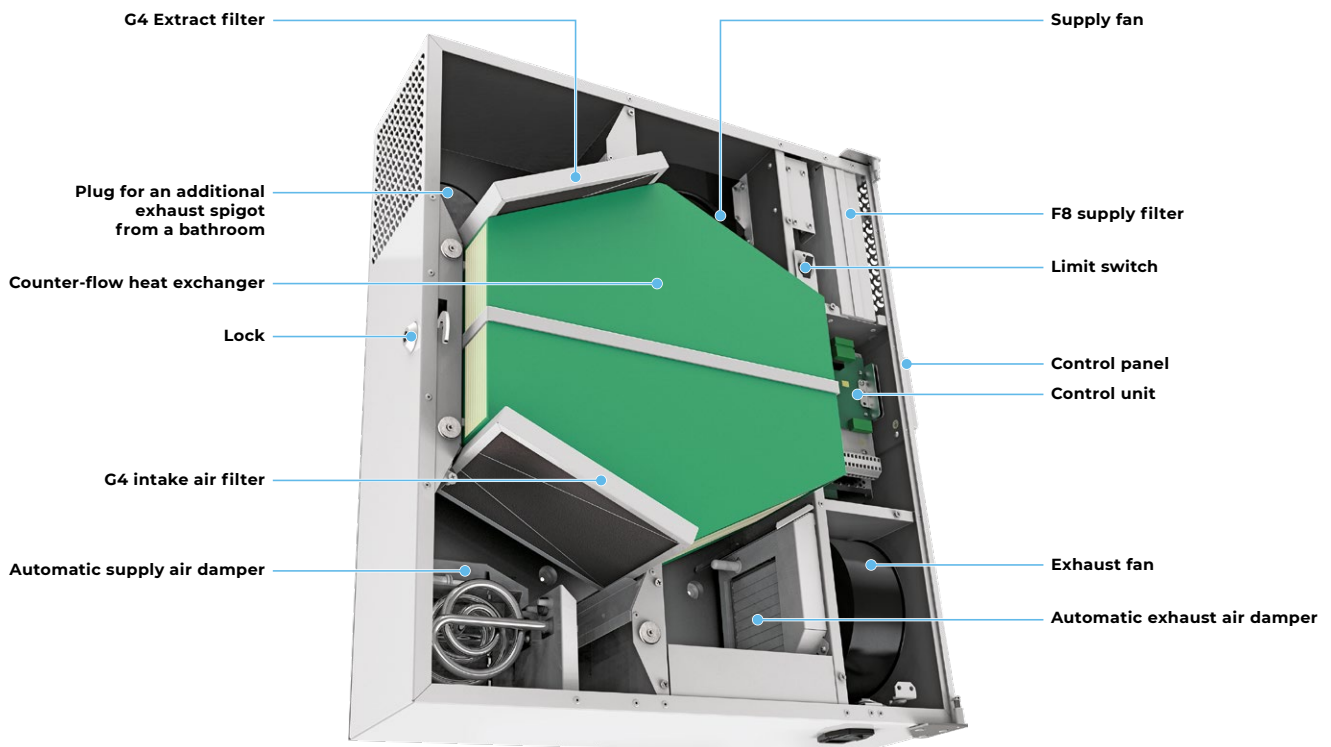

## Air filtration

Supply air cleaning is provided by the G4 and F8 panel filters (PM2.5 > 75 %). To meet more stringent air purity requirements the F8 filter can be replaced with an H13 (PM2.5 > 99 %) (purchased separately). Exhaust air is cleaned by the panel filter G4.

## Control

The unit is equipped with a control panel.

The remote control is supplied as standard.

Functions	Freshbox E-100
Speed changeover	•
Filter replacement indication	•
Alarm indication	•
Speed setting	•
Timer	•
Weekly schedule	•

## Air dampers

The unit is equipped with supply and exhaust air dampers which activate automatically to prevent drafts while the unit is off.

## Heat exchanger

The **Freshbox 100 ERV** units are equipped with a counter-flow heat exchanger with an enthalpy membrane at the core.

- In the cold season the exhaust air heat and moisture are transferred to the supply air stream through the enthalpy membrane reducing the heat losses through ventilation.
- In warm season the heat and humidity of the outdoor air is absorbed by extract air flow through the enthalpy membrane. This way the supply air temperature and humidity decreases and heat recovery reduces operation loads for the air conditioner.

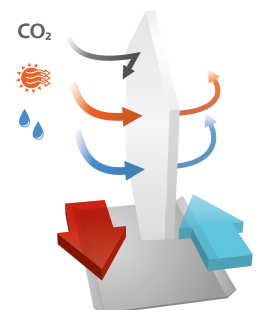

## Operating principle

The cold outdoor air passes through the filters and the heat exchanger and then is delivered to the serviced space by the supply centrifugal fan.

Warm polluted air from the premise flows through the filter and the heat exchanger and is exhausted outside with an extract centrifugal fan through an air duct in the wall.

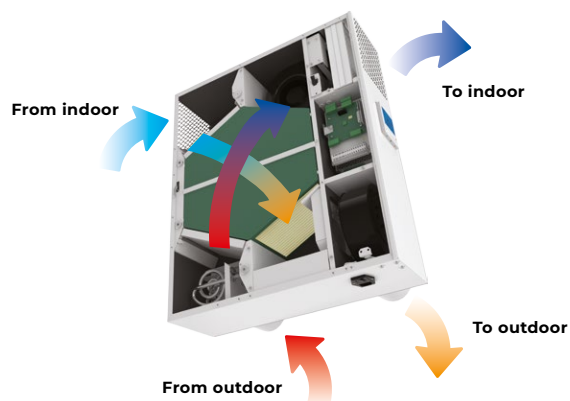

The supply and exhaust air flows are fully separated which helps eliminate the possibility of odour or microbial transfer between the streams.

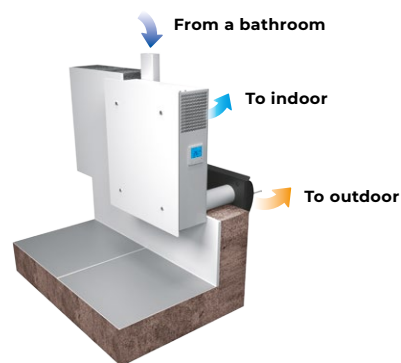

Operating principle with extra spigot for bathroom exhaust ventilation

## Technical data

Parameters	Freshbox 100 ERV		
Speed	1	2	3
Voltage [V / 50-60 Hz]	1~110-240		
Max. unit power [W]	12	21	45
Max. unit current [A]	0.4		
Maximum air flow [m³/h (l/s)]	30 (8)	60 (17)	100 (28)
RPM [min <sup>-1</sup> ]	2200		
Sound pressure level at 3 m distance [dBA]	13	27	39
Max. operating temperature [°C]	-20...+40		
Case material	polymer coated steel		
Insulation [mm]	10		
Extract filter	G4		
Supply filter	G4, F8 (Option: F8 C, H13)		
Connected air duct diameter [mm]	100		
Weight [kg]	31		
Temperature exchange efficiency (heating) [%]	83...96		
Temperature exchange efficiency (cooling) [%]	73...89		
Enthalpy exchange efficiency (heating) [%]	73...85		
Enthalpy exchange efficiency (cooling) [%]	70...85		
Heat exchanger type	counter-flow		
Heat exchanger material	enthalpic membrane		

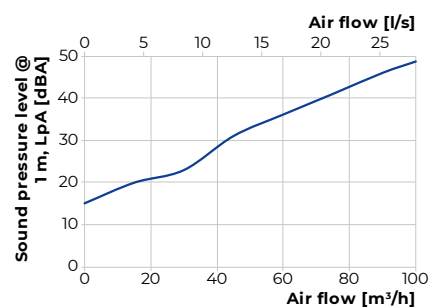
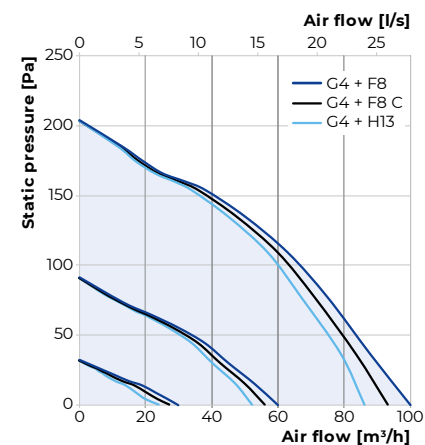

Sound-power level, A - weighted	Total	Octave frequency band [Hz]								LpA 3 m	LpA 1 m
		63	125	250	500	1000	2000	4000	8000		
LWA to environment [dBA]	49	45	40	44	38	33	29	27	22	28	38

## Overall dimensions [mm]

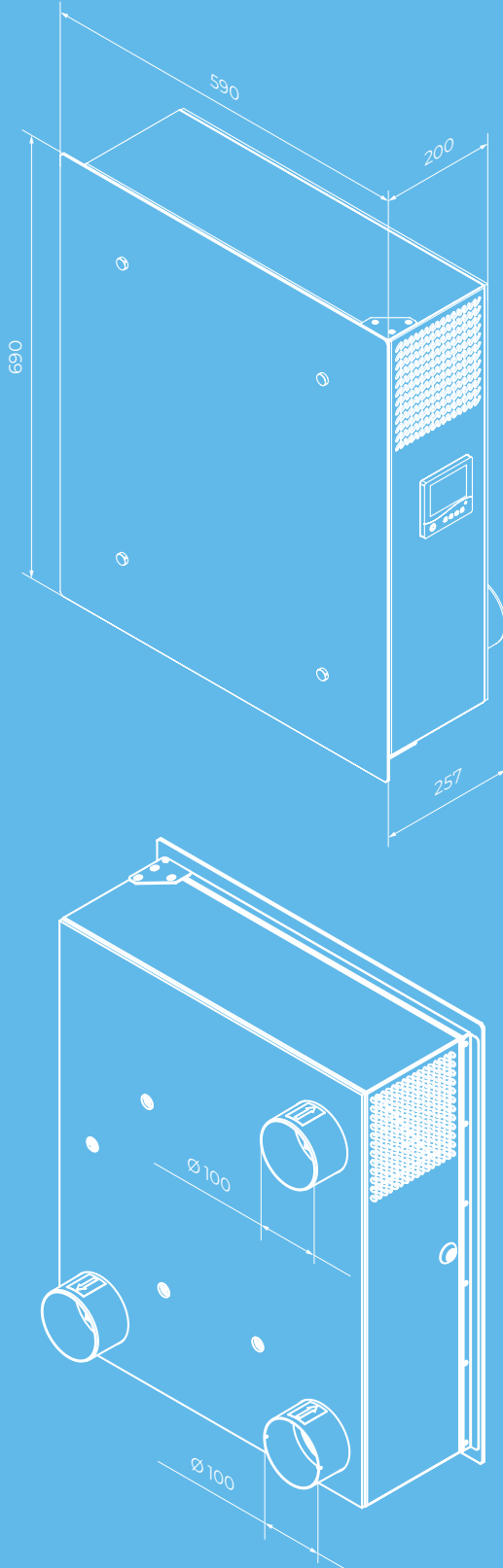

## Mounting example

Each space requiring ventilation is equipped with one or several **Freshbox 100 ERV** units.

A single unit is capable to ensure efficient ventilation in spaces with floor area up to 75 m<sup>2</sup>.

**Freshbox 100 ERV** units can be upgraded with a bathroom exhaust air duct. To enable such a configuration the units can be additionally equipped with the optional Ø 100 mm spigot (supplied as standard).



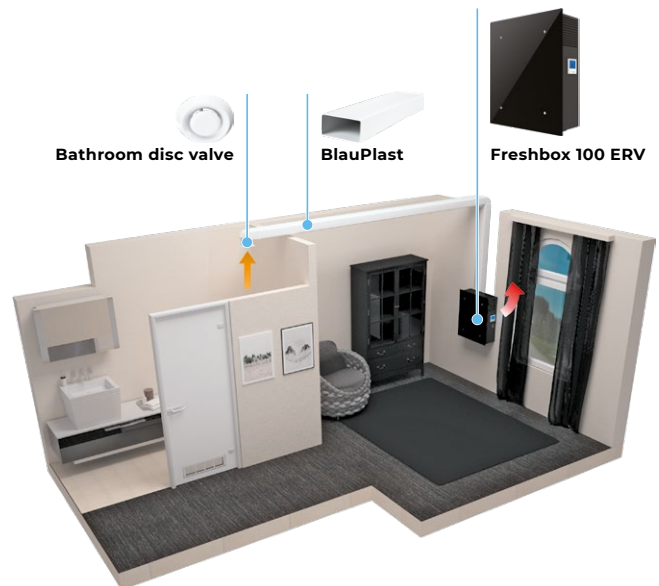



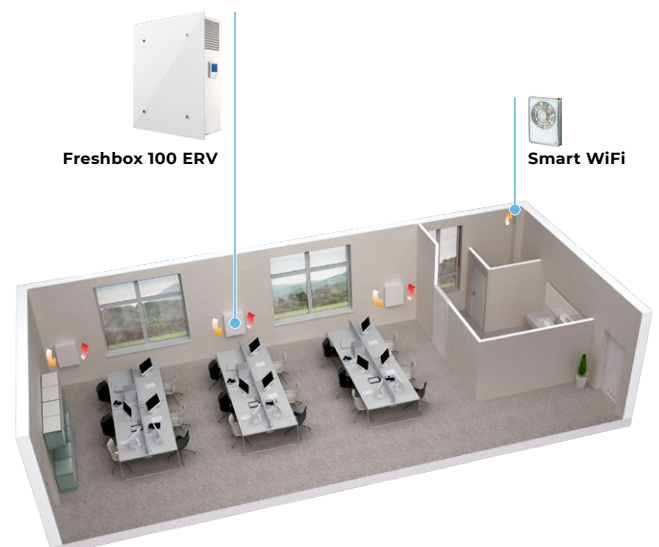

### Freshbox 100 ERV deployment in a compact residential space



### Freshbox 100 ERV mounting example in the office



## Accessories

Name		Description
<b>MS Freshbox 100 chrome</b>		<b>Mounting kit:</b> <ul style="list-style-type: none"> <li>• Two Ø 100 mm air ducts, 500 mm long</li> <li>• Ventilation outer hood made of polished steel</li> <li>• Cardboard template</li> </ul>
<b>MS Freshbox 100 white</b>		<b>Mounting kit:</b> <ul style="list-style-type: none"> <li>• Two Ø 100 mm air ducts, 500 mm long</li> <li>• Ventilation outer hood, painted white</li> <li>• Cardboard- template</li> </ul>
<b>AH Freshbox 100 chrome</b>		Ventilation outer hood made of polished steel
<b>AH Freshbox 100 white</b>		Ventilation outer hood, painted white
<b>FP 193x158x18 G4 PPI</b>		G4 filter
<b>FP 193x158x47 F8</b>		F8 filter
<b>FP 193x158x47 F8 C</b>		F8 carbon filter
<b>FP 193x158x47 H13</b>		H13 HEPA filter
<b>HR-S</b>		Humidity sensor
<b>CD-1</b>		CO <sub>2</sub> sensor with LED CO <sub>2</sub> indication and a sensor button for operation mode selection
<b>CD-2</b>		CO <sub>2</sub> sensor



# FRESHBOX 100

## ERV WI-FI

**DECENTRALIZED SUPPLY AND EXHAUST UNIT WITH HEAT RECOVERY**



100 m<sup>3</sup>/h



from 13 dBA



up to 98 %



## FEATURES

Efficient solution for supply and exhaust ventilation of enclosed spaces.

Heat exchanger with an enthalpy membrane modification available for humid and hot climate conditions.

Low-energy EC motors.

Upgradeable with an exhaust duct to provide air extraction from the bathroom.

Silent operation.

Easy installation.

Compact size.

Controlled by Android or iOS smartphone or tablet over Wi-Fi.

Air ducts can be taken out through the windows.

## Design

Polymer coated metal casing decorated with an acrylic front panel. Heat and noise insulation is ensured by a layer of 10 mm cellular synthetic rubber.

The front panel provides convenient access for filter maintenance and has a lock for extra security.

The unit has two Ø 100 mm pipes for fresh air intake and stale air extraction outside. The third Ø 100 mm pipe (included in the scope of delivery) can be additionally fitted to the unit to connect the exhaust air duct from the bathroom.

## Motors

The units feature efficient electronically commutated (EC) motors with an external rotor and impellers with forward curved blades. These state-of-the-art motors are the most advanced solution in energy efficiency today.

EC motors are characterised with high performance and optimum control across the entire speed range. In addition to that the efficiency of electronically commutated motors reaches very impressive levels of up to 90 %.



## Design

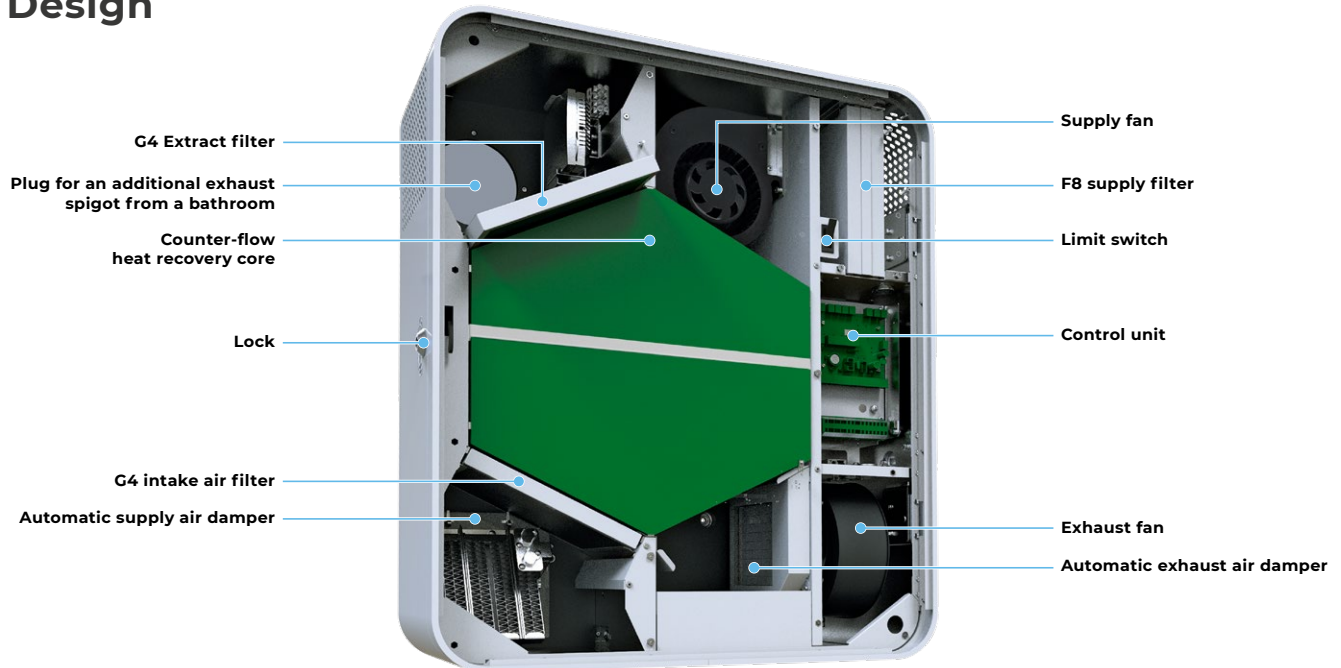

## Air dampers

The unit is equipped with supply and exhaust air dampers which activate automatically to prevent drafts while the unit is off.

## Air filtration

Supply air cleaning is provided by the G4 and F8 filters. To meet more stringent air purity requirements the F8 filter can be replaced with an H13 or F8 carbon filter (purchased separately). Exhaust air is cleaned by the filter G4.

## Operating principle

The supply and exhaust air flows are fully separated which helps eliminate the possibility of odour or microbial transfer between the streams.

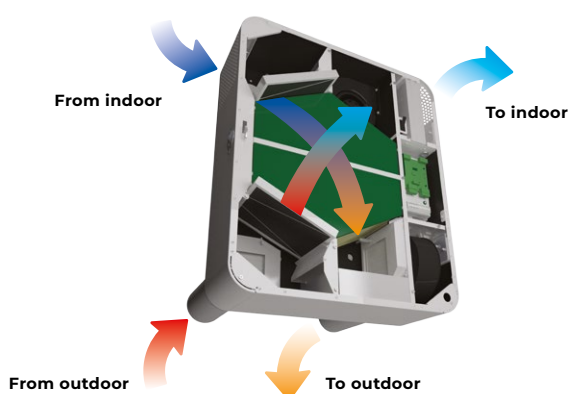

## Heat exchanger

The **Freshbox 100 ERV WiFi** units are equipped with a counter-flow energy recovery core with an enthalpy membrane at the core.

- In warm season the heat and humidity of the outdoor air is absorbed by extract air flow through the enthalpy membrane. This way the supply air temperature and humidity decreases and heat recovery reduces operation loads for the air conditioner.

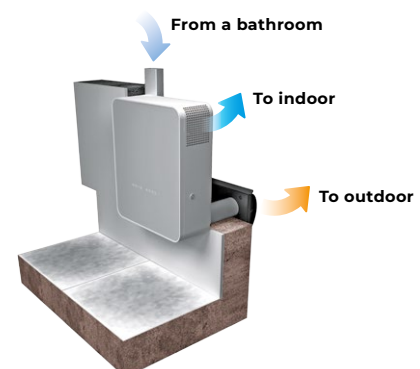
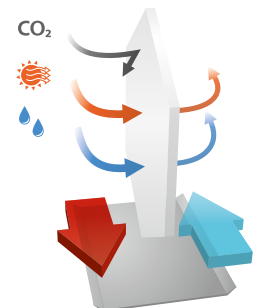

Operating principle with extra spigot for bathroom exhaust ventilation

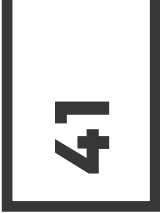

## Control

The unit is equipped with a control panel.

The remote control is supplied as standard

Wi-Fi communication.



### REMOTE CONTROL

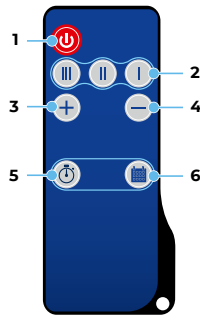

- 1 Turning unit on/off
- 2 Speed selection (Min/Mid/Max)
- 3 Increasing temperature set point for the reheater (available for the models with a reheater)
- 4 Decreasing temperature set point for the reheater (available for the models with a reheater)
- 5 Turning timer on/off
- 6 Activation/deactivation of the scheduled operation mode

### AUTOMATIC FUNCTIONS

Freshbox 100 WiFi	
Speed selection	•
Filter replacement indication	•
Alarm indication	•
Speed setup	•
Timer	•
Week scheduler	•
Supply air temperature setup	
Control with the mobile application Android / iOS	•

### CONTROL PANEL

- ON/OFF button
- Speed changeover (down)
- Speed changeover (up)
- Weekly schedule
- Connection to WiFi
- Filter replacement indication
- Alarm indication

## Technical data

Parameters	Freshbox 100 ERV WiFi				
Speed	I	II	III	IV	V
Voltage [V / 50 (60) Hz]	1~110-240				
Max. power [W]	20	23	29	37	53
Max. current consumption [A]	0.4				
Maximum air flow [m³/h (l/s)]	30 (8)	44 (12)	60 (17)	75 (21)	100 (28)
RPM [min <sup>-1</sup> ]	max 2200				
Sound pressure level at 3 m [dBA]	13	20	27	33	39
Transported air temperature [°C]	-20...+40				
Casing material	polymer coated steel				
Insulation thickness [mm]	10				
Extract filter	G4				
Supply filter	G4 + F8 (Option: F8 Carbon; H13)				
Connected air duct diameter [mm]	100				
Weight [kg]	31				
Temperature exchange efficiency (heating) [%]	83...96				
Temperature exchange efficiency (cooling) [%]	73...89				
Enthalpy exchange efficiency (heating) [%]	73...85				
Enthalpy exchange efficiency (cooling) [%]	70...85				
Heat recovery core type	counter-flow				
Heat exchanger material	enthalpic membrane				

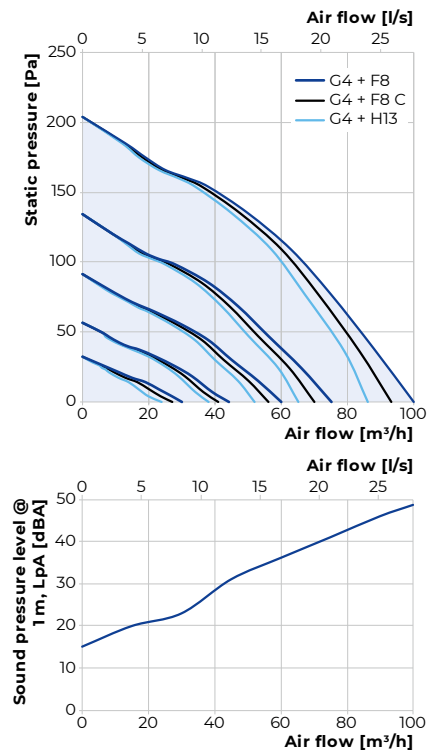

Sound-power level, A - weighted	Total	Octave frequency band [Hz]								LpA 3 m	LpA 1 m
		63	125	250	500	1000	2000	4000	8000		
LWA to environment [dBA]	49	45	40	44	38	33	29	27	22	28	38

## Overall dimensions [mm]

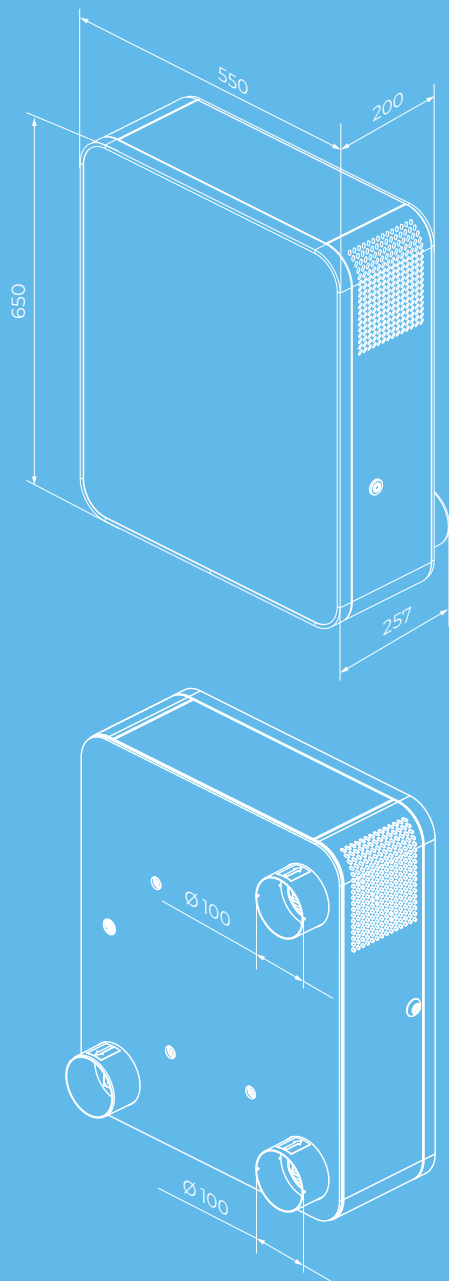

## Mounting example

Each space requiring ventilation is equipped with one or several **Freshbox 100 ERV WiFi** units.

A single unit is capable to ensure efficient ventilation in spaces with floor area up to 75 m<sup>2</sup>.

**Freshbox 100 ERV WiFi** units can be upgraded with a bathroom exhaust air duct. To enable such a configuration the units can be additionally equipped with the optional Ø 100 mm spigot (supplied as standard).

### Freshbox 100 ERV WiFi deployment in a compact residential space

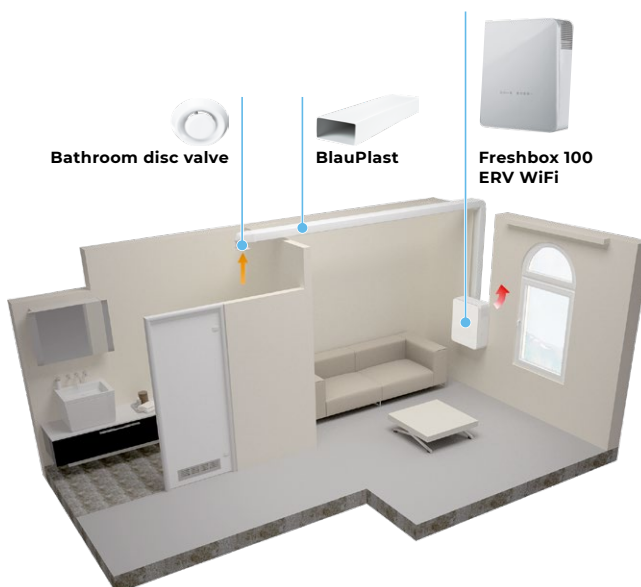

### Freshbox 100 ERV WiFi mounting example in the office

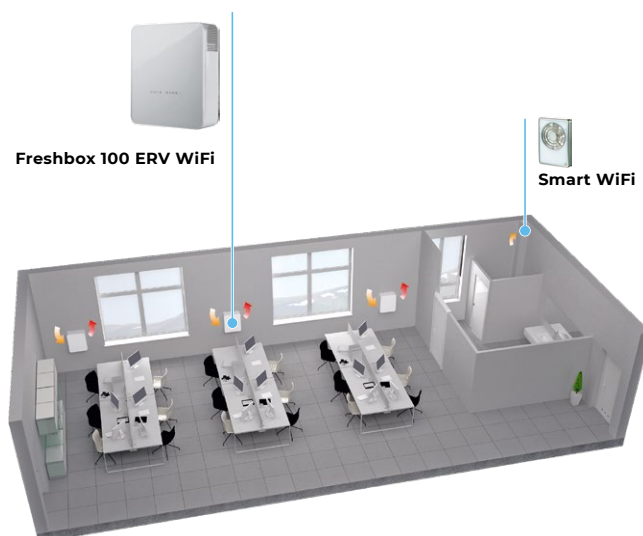









Download  
the Blaubeerg Home  
app for Android



Download  
the Blaubeerg Home  
app for iOS

## Accessories

Name		Description
<b>MS Freshbox 100 chrome</b>		<b>Mounting kit:</b> <ul style="list-style-type: none"> <li>• Two Ø 100 mm air ducts, 500 mm long</li> <li>• Ventilation outer hood made of polished steel</li> <li>• Cardboard template</li> </ul>
<b>MS Freshbox 100 white</b>		<b>Mounting kit:</b> <ul style="list-style-type: none"> <li>• Two Ø 100 mm air ducts, 500 mm long</li> <li>• Ventilation outer hood, painted white</li> <li>• Cardboard template</li> </ul>
<b>AH Freshbox 100 chrome</b>		Ventilation outer hood made of polished steel
<b>AH Freshbox 100 white</b>		Ventilation outer hood, painted white
<b>FP 193x158x18 G4 PPI</b>		G4 panel filter
<b>FP 193x158x47 F8</b>		F8 panel filter
<b>FP 193x158x47 F8 C</b>		F8 carbon panel filter
<b>FP 193x158x47 H13</b>		H13 HEPA panel filter
<b>HR-S</b>		Humidity sensor
<b>CD-1</b>		CO <sub>2</sub> sensor with LED CO <sub>2</sub> indication and a sensor button for operation mode selection
<b>CD-2</b>		CO <sub>2</sub> sensor



# FRESHBOX 110 ERV

## DECENTRALIZED SUPPLY AND EXHAUST UNIT WITH ENERGY RECOVERY



100 m<sup>3</sup>/h



from 10 dBA



up to 93 %



## FEATURES

High efficiency ventilation of a single room or a small apartment.

Flush or surface mounting option.

Optional connection of supply and extract 75 mm semi-rigid air ducts for flush mounted Freshbox 110 K1 unit.

Optional connection of 100 mm extract air duct for surface mounted Freshbox 110 unit.

Low noise level from 10 dBA at 3 m.

High level of wind protection.

Clean air with an ISO ePM1 65% / F7 supply filter.

Easy installation

## Designation key

Series	Rated air flow [m <sup>3</sup> /h]	Mounting	Heat exchanger type
<b>Freshbox:</b> decentralized ventilation unit	110	┌: surface mounting <b>K1:</b> flush mounting	┌: heat recovery <b>ERV:</b> heat and humidity recovery

## Design

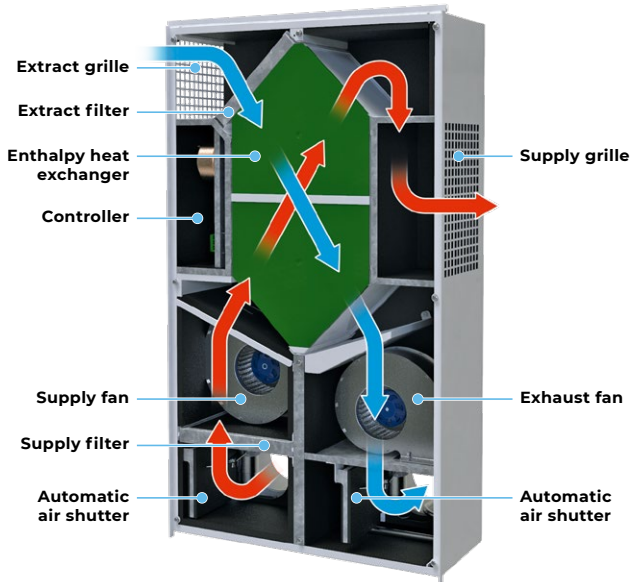

Freshbox 110 (wall surface mounting)

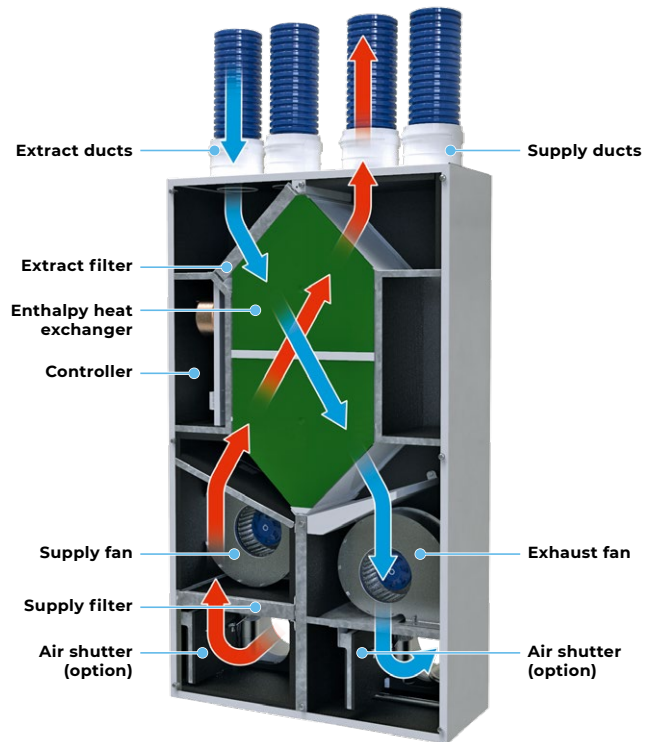

Freshbox 110 K1 (wall flush mounting)

## Casing

The casing is made of sheet metal, painted white, with a layer of heat and sound insulation. The modern design allows Freshbox 110 to fit harmoniously into any interior. The front panel opens easily for filter maintenance. The unit is equipped with two 100 mm spigots for air intake and exhaust.

## Fans

The unit is equipped with high-efficient electronically commutated (EC) motors with an external rotor equipped with impellers with forward-curved blades. Such motors are currently the most advanced solution in the field of energy saving. EC motors are characterized by high performance and optimal control over the entire range of speeds. The undoubted advantage of electronically commutated motors is high efficiency (up to 90%).

## Air filtration

Supply air is cleaned by a Coarse 90% / G4 cassette filter. An ePM1 65% / F7 filter can be installed as an option.

Extract air purification is performed by a Coarse 90% / G4 cassette filter.

## Air dampers

An automatic supply and exhaust air dampers are provided to prevent drafts when the unit is switched off.

## Heat exchanger

**Freshbox 110 ERV** units are equipped with a heat exchanger, which is made of enthalpy membrane and transfers heat and moisture.

In the warm season, the heat and moisture of fresh intake air are transferred through the enthalpy membrane to the extract air. This allows for a considerable reduction of the supply air temperature and humidity which, in turn, reduces the air conditioning load.

## Automation and control

Control panel on the side surface of the unit.

### FUNCTIONS

- On / off
- Speed switching
- Heat recovery mode
- Summer cooling mode
- Filter maintenance indication
- Alarm indication

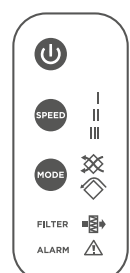

## Technical data

	Freshbox 110 ERV			Freshbox 110 K1 ERV		
	1	2	3	1	2	3
<b>Speed</b>	1	2	3	1	2	3
<b>Air flow [m³/h]</b>	30	60	100	30	60	100
<b>Voltage [V / 50-60 Hz]</b>	1~230			1~230		
<b>Power [W]</b>	10	15	31	10	15	31
<b>Max current [A]</b>	0.26			0.26		
<b>RPM [min<sup>-1</sup>]</b>	3200			3200		
<b>Sound power level LWA to environment [dBA]</b>	31	41	51	31	41	51
<b>Sound pressure level LpA to environment at 1 m distance [dBA]</b>	20	30	40	20	30	40
<b>Sound pressure level LpA to environment at 3 m distance [dBA]</b>	10	21	31	10	21	31
<b>Operating temperature [°C]</b>	-15...+40			-15...+40		
<b>Case material</b>	polymer coated steel			polymer coated steel, galvanized steel		
<b>Insulation [mm]</b>	10			10		
<b>Extract filter ISO 16890 / EN 779:2012</b>	Coarse 90% / G4			Coarse 90% / G4		
<b>Supply filter ISO 16890 / EN 779:2012</b>	Coarse 90% / G4 Optional: ePM1 65% / F7			Coarse 90% / G4 Optional: ePM1 65% / F7		
<b>Connected air duct diameter [mm]</b>	2×100 mm + optional 1×100 mm			2×100 mm + optional 4×75 mm		
<b>Weight [kg]</b>	20			23		
<b>Temperature recovery efficiency [%]</b>	85	80	72	85	80	72
<b>Heat exchanger type</b>	counter-flow			counter-flow		
<b>Heat exchanger material</b>	enthalpic			enthalpic		

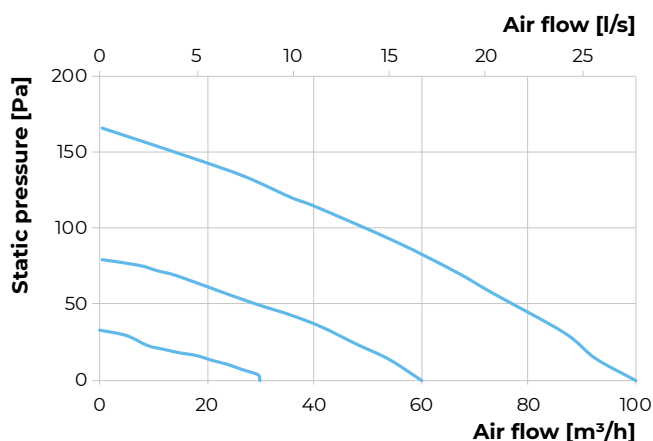

## Overall dimensions [mm]

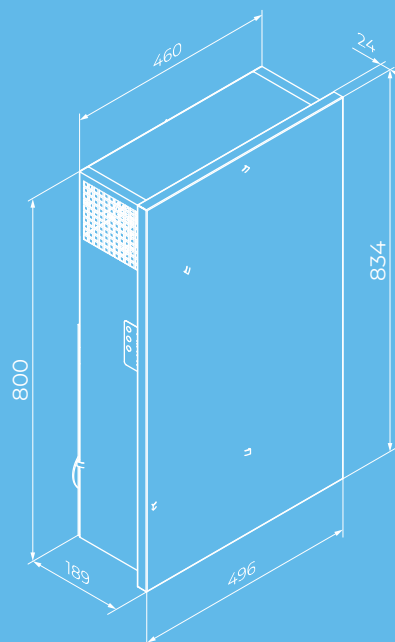

Freshbox 110 (wall surface mounting)

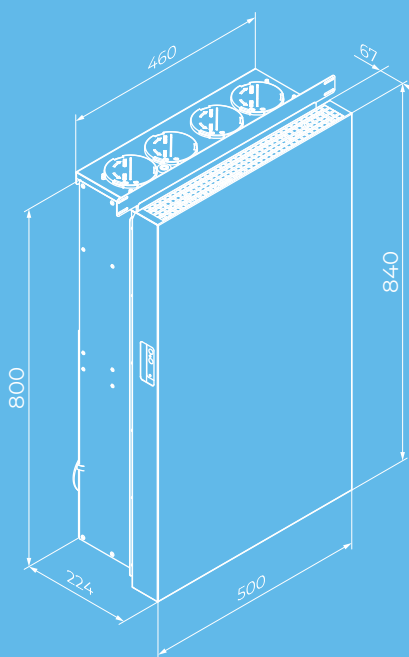

Freshbox 110 K1 (wall flush mounting)



# Mounting

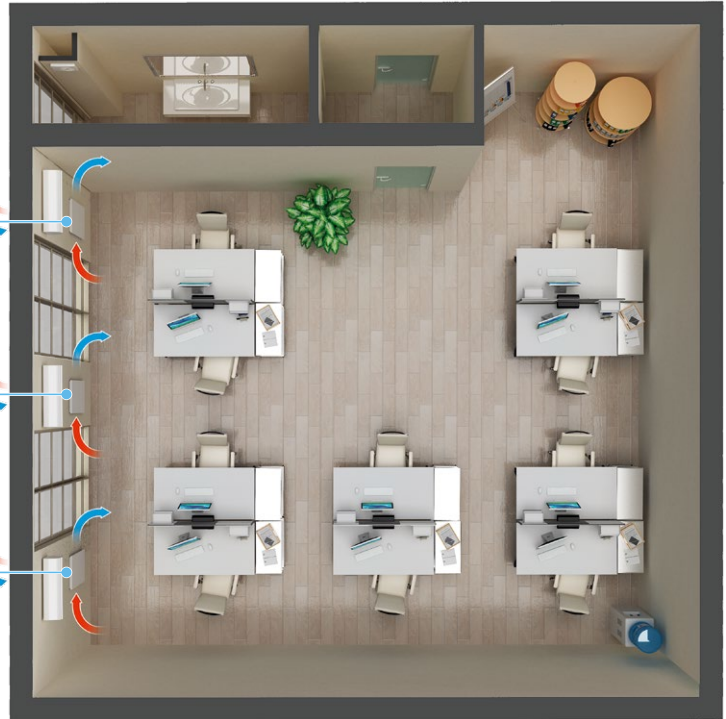

Wall surface mounting

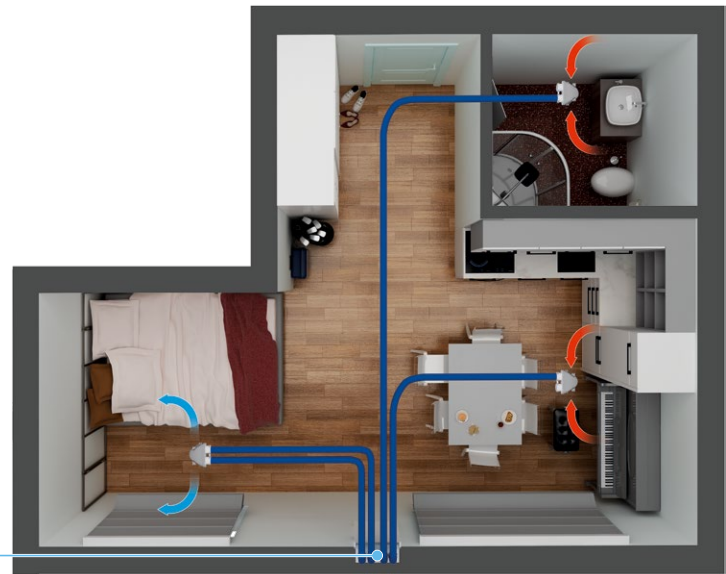

Wall flush mounting

## Accessories

 <p><b>FP 176x160x22</b> Coarse 90% / G4 Extract filter</p>	 <p><b>FP 203x150x22</b> Coarse 90% / G4 Supply filter</p>	 <p><b>FP 203x150x22</b> ePM1 65% / F7 Supply filter option</p>
 <p><b>MS Freshbox 110</b> Mounting kit</p>	 <p><b>MS Freshbox 110 white</b> Mounting kit</p>	 <p><b>MS Freshbox 110 chrome</b> Mounting kit</p>
 <p><b>MS1 Freshbox 110</b> Mounting kit for corner mounting of the grille in the window opening</p>	 <p><b>MS1 Freshbox 110 white</b> Mounting kit for corner mounting of the grille in the window opening</p>	 <p><b>MS1 Freshbox 110 chrome</b> Mounting kit for corner mounting of the grille in the window opening</p>
 <p><b>AH Freshbox 110</b> Supply and exhaust hood</p>	 <p><b>AH Freshbox 110 white</b> Supply and exhaust hood</p>	 <p><b>AH Freshbox 110 chrome</b> Supply and exhaust hood</p>
 <p><b>CD-1</b> CO<sub>2</sub> sensor</p>	 <p><b>CD-2</b> CO<sub>2</sub> sensor</p>	 <p><b>CD-3</b> CO<sub>2</sub> sensor</p>
 <p><b>HR-S</b> Humidity sensor</p>	 <p><b>RKF 75 kit</b> Air ducts with lock rings (4 pcs.)</p>	



# FRESHBOX 200

## ERV WI-FI

### DECENTRALIZED SUPPLY AND EXHAUST UNIT WITH HEAT RECOVERY



## FEATURES

Efficient solution for supply and exhaust ventilation of enclosed spaces.

EC fans with low energy consumption.

Supply air cleaning is provided by the G4 and F7 filters. Additional air purification due to recirculation. H13 filter is available as an option.

Easy installation.

Upgradeable with an exhaust duct to provide air extraction from the bathroom.

Compact size.

Controlled by Android or iOS smartphone or tablet over Wi-Fi.

Air ducts can be taken out through the windows.

### Design

The casing is made of polymer coated steel plates.

The front panel provides convenient access for filter maintenance and has a lock for extra security.

The unit has two Ø 100 mm pipes for fresh air intake and stale air extraction outside. The third Ø 100 mm pipe (included in the scope of delivery) can be additionally fitted to the unit to connect the exhaust air duct from the bathroom.

Available modifications with an integrated preheater and reheater for cold climate applications.

### Motors

The units feature efficient electronically commutated (EC) motors with an external rotor and impellers with forward curved blades. These state-of-the-art motors are the most advanced solution in energy efficiency today.

EC motors are characterised with high performance and optimum control across the entire speed range. In addition to that the efficiency of electronically commutated motors reaches very impressive levels of up to 90 %.

## Design

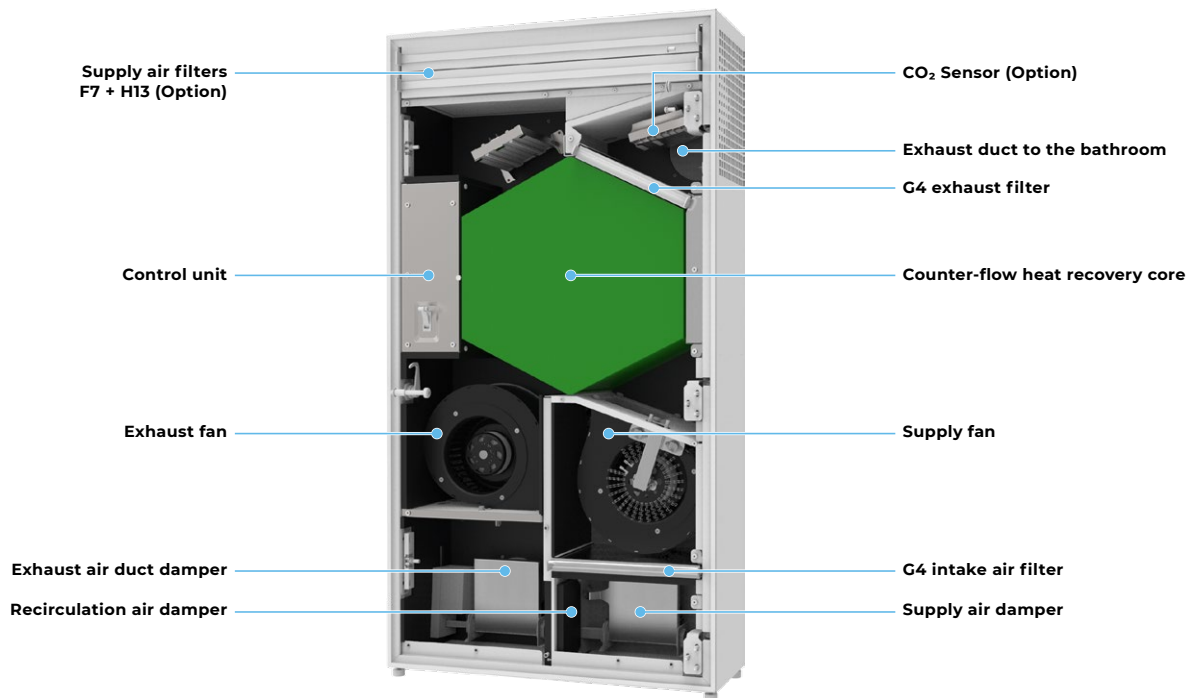

### Air dampers

The unit is equipped with supply and exhaust air dampers which activate automatically to prevent drafts while the unit is off.

### Air filtration

Supply air cleaning is provided by the G4 and F7 filters. To meet more stringent air purity requirements the F7 filter can be replaced with an H13 Filter (purchased separately).

Exhaust air is cleaned by the panel filter G4.

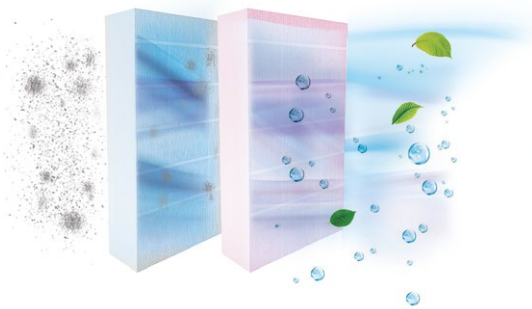

### Heat and energy recovery

The unit is equipped with a counter-flow energy recovery core with an enthalpy membrane at the core.

- **In the cold season** the exhaust air heat and moisture are transferred to the supply air stream through the enthalpy membrane reducing the heat losses through ventilation.
- Consequently, it is the intake air heat and moisture transferred to the extract air stream through the enthalpy membrane **in the warm season**. This allows for a considerable reduction of the supply air temperature and humidity which, in turn, reduces the air conditioning load.

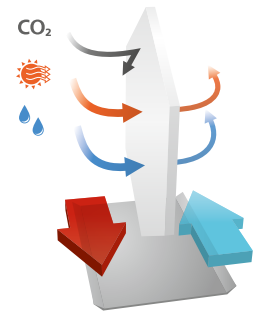

Download  
the Blaubeerg Home app  
for Android



Download  
the Blaubeerg Home app  
for iOS

## Operating principle

The supply and exhaust air flows are fully separated which helps eliminate the possibility of odour or microbial transfer between the streams.

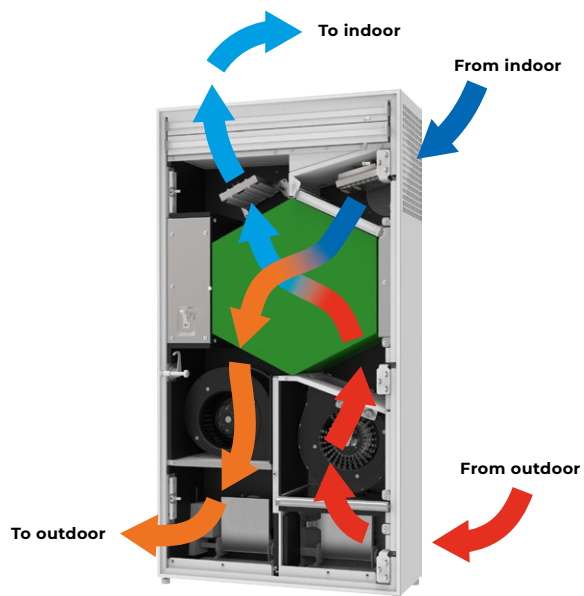

### RECIRCULATION OPERATION MODE

The supply and exhaust air dampers are closed, the recirculation damper is open. The room air circulates through the filters. Then it is returned back to the room purified.

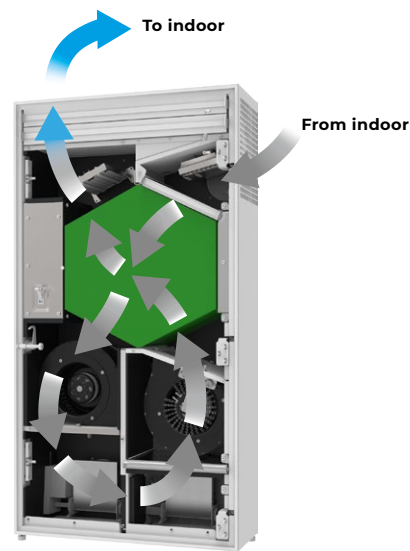

## Control

The unit is equipped with a control panel.

The remote control is supplied as standard

Wi-Fi communication.



### REMOTE CONTROL

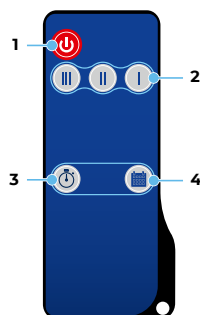

- 1 Turning unit on/off
- 2 Speed selection (Min/Mid/Max)
- 3 Turning timer on/off
- 4 Activation/deactivation of the scheduled operation mode

### AUTOMATIC FUNCTIONS

	Freshbox 200 ERV WiFi Freshbox E-200 ERV WiFi	Freshbox E1-200 ERV WiFi Freshbox E2- 200 ERV WiFi
<b>Speed selection</b>	•	•
<b>Filter replacement indication</b>	•	•
<b>Alarm indication</b>	•	•
<b>Speed setup</b>	•	•
<b>Timer</b>	•	•
<b>Week scheduler</b>	•	•
<b>Reheater enabled/ disabled</b>		•
<b>Control with the mobile application Android / iOS</b>	•	•

### CONTROL PANEL

-  ON/OFF button
-  Weekly schedule
-  Speed changeover (down)
-  Connection to WiFi
-  Speed changeover (up)
-  Filter replacement indication
-  Alarm indication

## Technical data

Parameters	Freshbox 200 ERV WiFi				
Speed	I	II	III	IV	V
Voltage [V / 50 (60) Hz]	1~230				
Max. power [W]	10	15	25	44	134
Max. current consumption [A]	1.0				
Maximum air flow [m <sup>3</sup> /h (l/s)]	30 (8)	60 (17)	90 (25)	120 (33)	200 (56)
RPM [min <sup>-1</sup> ]	2000				
Sound pressure level at 3 m [dBA]	12	22	30	36	45
Transported air temperature [°C]	-15...+40				
Casing material	polymer coated steel				
Insulation thickness [mm]	30				
Extract filter	G4				
Supply filter	G4 + F7 (Option: H13)				
Connected air duct diameter [mm]	100				
Weight [kg]	55				
Temperature recovery efficiency [%]	85	81	75	68	66
Heat recovery core type	counter-flow				
Heat recovery core material	enthalpic membrane				

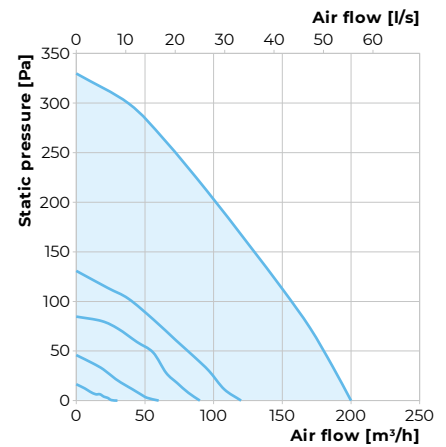

## Overall dimensions [mm]

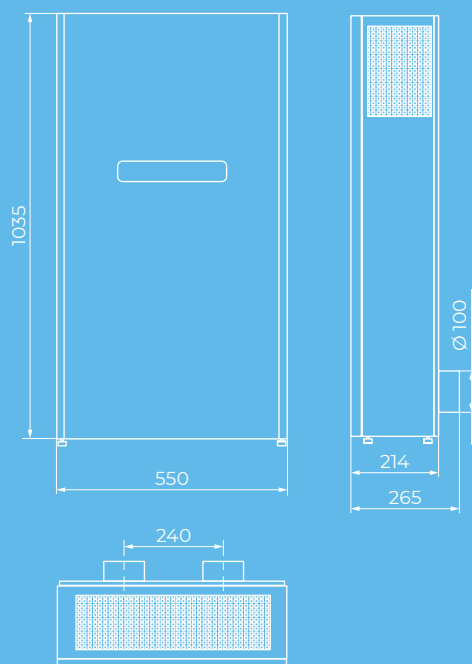

Air ducts can be taken out through the windows

## Mounting example

Each space requiring ventilation is equipped with one or several **Freshbox 200 ERV WiFi** units.

Can be upgraded with a bathroom exhaust air duct. To enable such a configuration the units can be additionally equipped with the optional  $\varnothing$  100 mm spigot (supplied as standard).



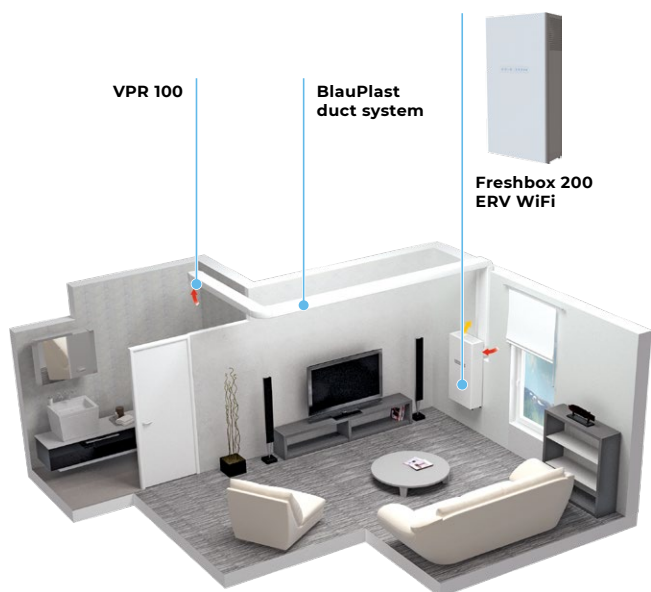



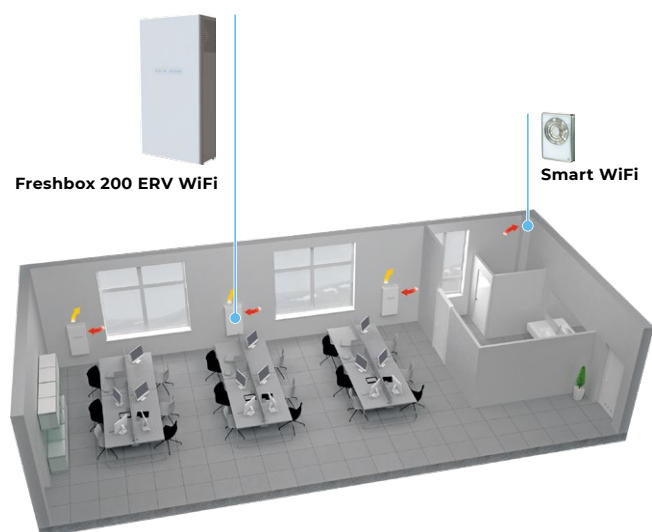



Freshbox 200 ERV WiFi mounting example in the apartment



Freshbox 200 ERV WiFi mounting example in the office



## Accessories

Name		Description
<b>MS Freshbox 200 chrome</b>		<b>Mounting kit:</b> <ul style="list-style-type: none"> <li>Two <math>\varnothing</math> 100 mm air ducts, 500 mm long</li> <li>Ventilation outer hood made of polished steel</li> <li>Cardboard template</li> </ul>
<b>MS Freshbox 200 white</b>		<b>Mounting kit:</b> <ul style="list-style-type: none"> <li>Two <math>\varnothing</math> 100 mm air ducts, 500 mm long</li> <li>Ventilation outer hood, painted white</li> <li>Cardboard template</li> </ul>
<b>AH Freshbox 200 chrome</b>		Ventilation outer hood made of polished steel
<b>AH Freshbox 200 white</b>		Ventilation outer hood, painted white
<b>FP 201x162x20 G4</b>		Exhaust G4 panel filter
<b>FP 243x162x20 G4</b>		Supply G4 panel filter
<b>FP 502x162x40 F7</b>		Supply F7 panel filter
<b>FP 502x162x40 H13</b>		Supply HEPA H13 panel filter
<b>HR-S</b>		Humidity sensor
<b>CD-1</b>		CO <sub>2</sub> sensor with LED CO <sub>2</sub> indication and a sensor button for operation mode selection
<b>CD-2</b>		CO <sub>2</sub> sensor





# HYBRID MAX ERV

**DECENTRALIZED UNIT  
FOR THE SMALL OFFICES,  
FACILITIES, CLASSROOMS  
AND LIVING SPACES**



**160** m<sup>3</sup>/h



from  
**16** dBA



up to  
**95** %



## FEATURES

Efficient decentralized ventilation unit for small offices or conference rooms.

Visible ceiling suspended installation.

Clean air due to the use of an F7 filter for supply air filtration.

Low noise operation from 16 dBA at 3m.

Possibility to connect fresh air inlet and exhaust air ducts at top or back side of the unit.

High level of comfort due to built-in bypass and air dampers.

Air ducts can be taken out through the windows.

### Casing

The casing is made of galvanized sheet metal with white painted decorative cover. The contemporary design of the Hybrid Max unit will seamlessly blend into any interior. The unit is heat- and sound-insulated with a 20 mm layer of foam. The service panel is easy to open for filter maintenance. The unit is equipped with two Ø 125 mm spigots for fresh air intake and stale air exhaust. The position of the spigots can be changed from horizontal to vertical.

### Bypass

The **Hybrid Max ERV** units are equipped with a bypass for ventilation (air cooling by the cool air from outside).

### Air dampers

The **Hybrid Max ERV** unit is equipped with two automatic air dampers, which close automatically when the unit is off to prevent drafts.

### Fans

The units feature high-performance, electronically commutated (EC), external rotor motors with forward curved blades. These state-of-the-art units offer excellent energy efficiency. In addition to that, EC motors combine high performance and optimum control over the entire speed range. EC motors have an excellent power efficiency (up to 90 %).

## Design

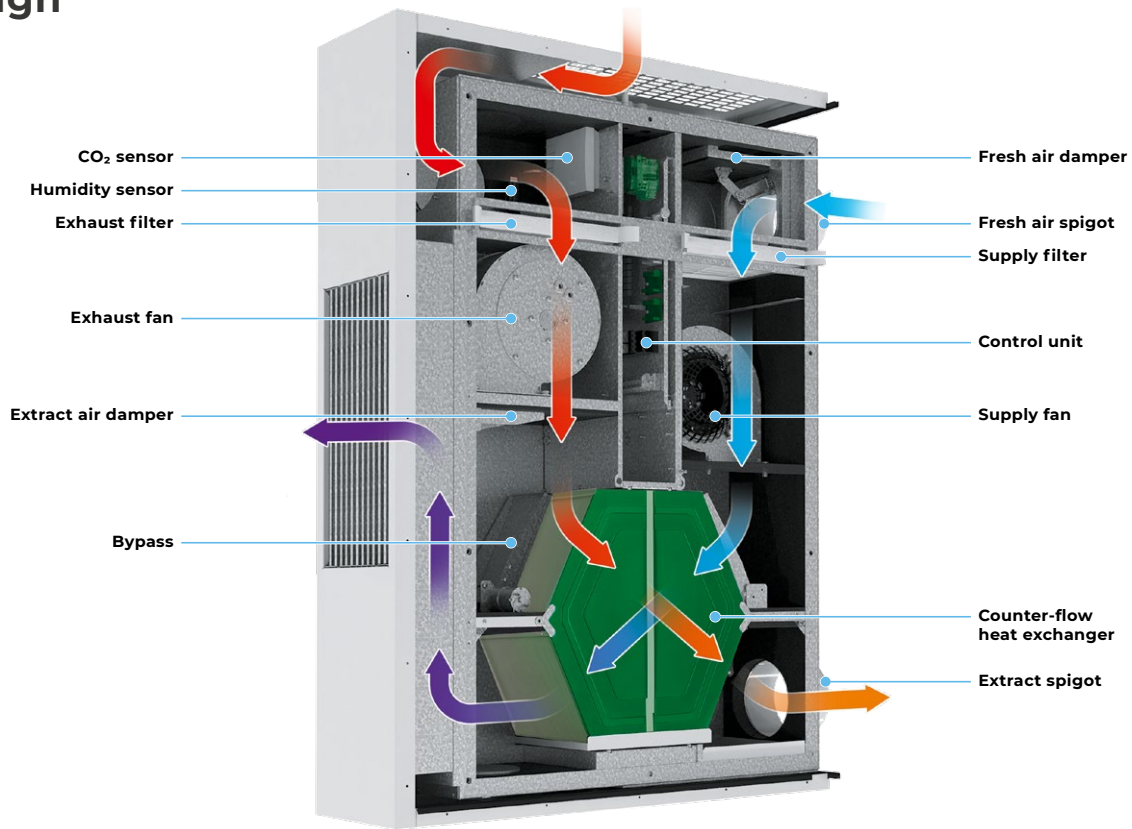

## Air distribution



## Heat recovery

The **Hybrid Max ERV** unit is equipped with an enthalpy plate counter-flow heat exchanger for energy (heat and humidity) recovery. Due to humidity recovery condensate is not generated in the enthalpy heat exchanger.

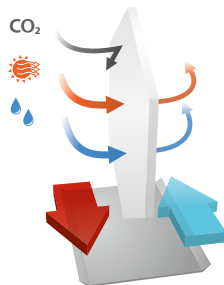

The air flows are completely separated in the heat exchanger. Thus smells and contaminants are not transferred from the extract air to the supply air.

Heat recovery is based on heat and/or humidity transfer through the heat exchanger plates. In the cold season supply air is heated in the heat exchanger by transferring the heat energy of warm and humid extract air to the cold fresh air. Heat recovery minimizes ventilation heat losses and heating costs respectively.

In the warm season the heat exchanger performs reverse and intake air is cooled in the heat exchanger by the cool extract air. That reduces operation load on air conditioners and saves electricity.

## Control and automation

The **Hybrid Max ERV S21** units are equipped with an integrated automation system. The remote control panel is not included in the delivery set (sold separately).





The S21 controller allows integrating the unit into the Smart Home system or **BMS (Building Management System)**.

Unit control via Wi-Fi using the mobile application Blauberg AHU.

The **Hybrid Max ERV S14** units are equipped with an integrated automation system and the S14 wall mounted sensor control panel with LED-indication.



## Automation functions

Functions	Hybrid Max S21	Hybrid Max S14
<b>Unit control via Wi-Fi using a mobile application</b>	+	-
<b>Unit control via a wired remote control panel</b>	 S22 control panel (option)	 S14 control panel
<b>Unit control via a wireless remote control panel</b>	 S22 Wi-Fi control panel (option)	-
<b>Unit control via a remote wired LCD control panel</b>	 S25 control panel (option)	-
<b>BMS (Building Management System)</b>	RS-485	-
	Wi-Fi	-
	Ethernet	-
	MODBUS (RTU, TCP)	-
<b>Speed selection</b>	+	+
<b>Filter replacement indication</b>	by filter timer	by filter timer
<b>Alarm indication</b>	full alarm description in the mobile application	-
<b>Week-scheduled operation</b>	+	-
<b>Bypass</b>	automatic	manual
	manual	-
<b>Timer</b>	+	-
<b>Boost mode</b>	+	-
<b>Fireplace mode</b>	+	-
<b>Cooler connection</b>	option	-
<b>Minimum supply air temperature control</b>	option	-
<b>Humidity control</b>	option	option
<b>CO<sub>2</sub> control</b>	option	option
<b>VOC control</b>	option	option
<b>PM2.5 control</b>	option	option
<b>Fire alarm sensor connection</b>	option	-

## Technical data

Model	Hybrid Max ERV		
Voltage [V / 50/60 Hz]	1~ 230		
Max. unit power [W]	58		
Max. unit current [A]	0.5		
Max air flow [m <sup>3</sup> /h]	160		
RPM [min <sup>-1</sup> ]	2800		
Speed [m <sup>3</sup> /h]	60	90	160
Sound pressure level LpA to environment at 1 m [dBA]	25	35	42
Sound pressure level LpA to environment at 3 m [dBA]	16	26	32
Operating temperature [°C]	-25...+40		
Case material	Aluzinc		
Insulation [mm]	20		
Extract filter	Coarse 90% / G4		
Supply filter	ePM1 70% / F7 (G4 option)		
Connected air duct diameter [mm]	125		
Weight [kg]	47		
Temperature recovery efficiency [%]	74-89		
Heat exchanger type	Counter-flow		
Heat exchanger material	Enthalpic membrane		

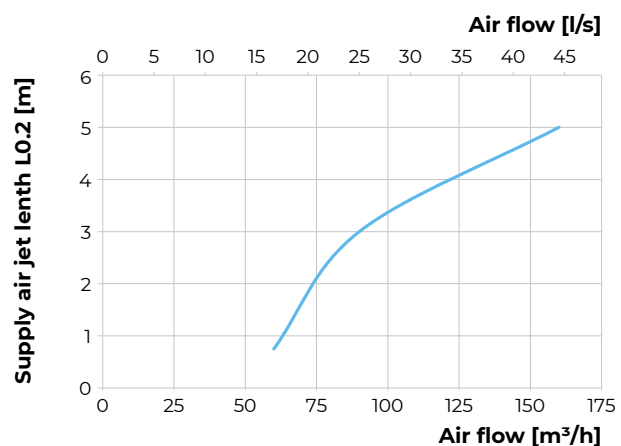
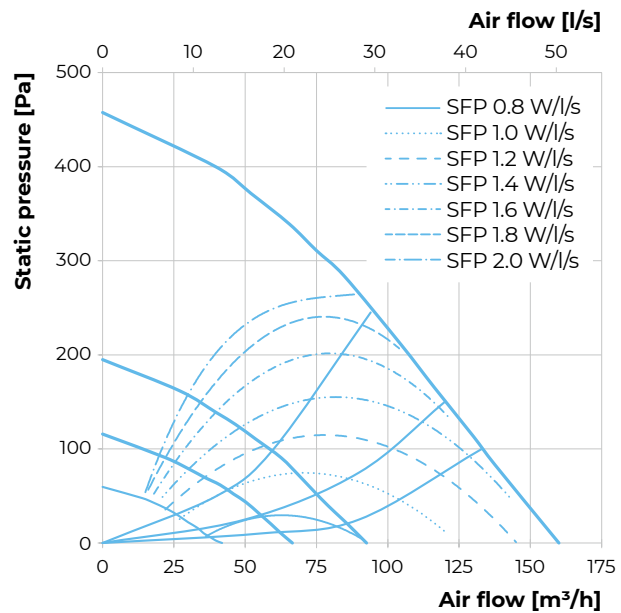

## Sound power level

Sound power level, A-weighted	Total	Octave frequency bands [Hz]										LpA 3 m	LpA 1 m
		200	250	315	400	500	630	800	1000	1250			
LwA to environment at 160 m <sup>3</sup> /h	<b>53</b>	37	41	41	45	49	40	42	41	38	<b>32</b>	<b>42</b>	
LwA to environment at 90 m <sup>3</sup> /h	<b>46</b>	31	37	43	36	35	33	34	33	30	<b>26</b>	<b>35</b>	
LwA to environment at 60 m <sup>3</sup> /h	<b>36</b>	32	25	24	25	24	23	23	21	19	<b>16</b>	<b>25</b>	

Sound power level, A-weighted	Total	Octave frequency bands [Hz]										LpA 3 m	LpA 1 m
		1600	2000	2500	3150	4000	5000	6300	8000	10000			
LwA to environment at 160 m <sup>3</sup> /h	<b>53</b>	37	37	35	31	27	23	21	24	25	<b>32</b>	<b>42</b>	
LwA to environment at 90 m <sup>3</sup> /h	<b>46</b>	29	29	27	24	21	19	19	23	24	<b>26</b>	<b>35</b>	
LwA to environment at 60 m <sup>3</sup> /h	<b>36</b>	18	18	19	17	17	18	19	23	24	<b>16</b>	<b>25</b>	

## Overall dimensions [mm]

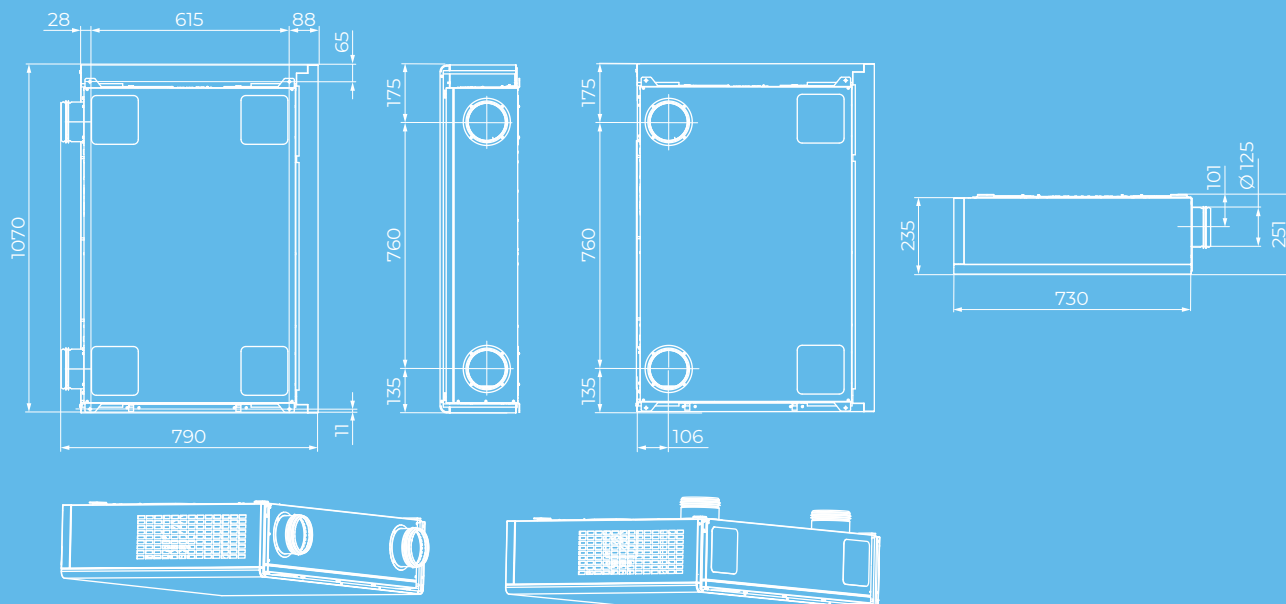

## Mounting

Mounting to the supporting structure.  
The spigots pass through the front wall



Mounting through  
a suspended ceiling

















Mounting to the supporting structure



The spigots pass  
through the front wall

## Accessories

		Hybrid Max ERV S14	Hybrid Max ERV S21
<b>G4 panel filter</b>		FP 233x175x22 G4	FP 233x175x22 G4
<b>F7 panel filter</b>		FP 233x175x22 F7	FP 233x175x22 F7
<b>Control panel</b>		-	S22
<b>Wireless control panel</b>		-	S22 Wi-Fi
<b>LCD control panel</b>		-	S25
<b>Humidity sensor</b>		FS2	FS2
<b>Humidity sensor</b>		HR-S	HR-S
<b>Humidity sensor</b>		-	DPWC11200
<b>CO<sub>2</sub> sensor with indication</b>		CD-1	CD-1
<b>CO<sub>2</sub> sensor</b>		CD-2	CD-2
<b>CO<sub>2</sub> sensor</b>		CD-3	CD-3
<b>CO<sub>2</sub> sensor</b>		-	DPWQ40200

		Hybrid Max ERV S14	Hybrid Max ERV S21
<b>VOC sensor</b>		-	DPWQ30600
<b>Electric reheater</b>		ENH S21 V.2	ENH S21 V.2
<b>Outer grille</b>		VDA 125 CFn AI	VDA 125 CFn AI





# VENTO ERGO A50(85)-1 PRO V.3

## HEAT RECOVERY SINGLE-ROOM UNITS



up to  
**85** m<sup>3</sup>/h



from  
**13** dBA



up to  
**93** %



## FEATURES

Arrangement of efficient energy-saving supply and exhaust single-room ventilation in flats, houses, cottages, social and commercial premises.

Heat recovery minimises ventilation heat losses.

Reduce the heating costs in winter and air conditioning costs in summer.

Coordinated network based on several integrated single-room ventilation units with central control.

## Designation key

Model	Air duct	Rated air flow [m <sup>3</sup> /h]	Front panel	Hood type	Control
Vento Ergo	<b>A:</b> round air duct	50; 85	<b>-1:</b> flat front panel	<b>S:</b> AH-S chrome 150 metal hood for thin walls	<b>Pro:</b> three-position switches and remote control

## Design

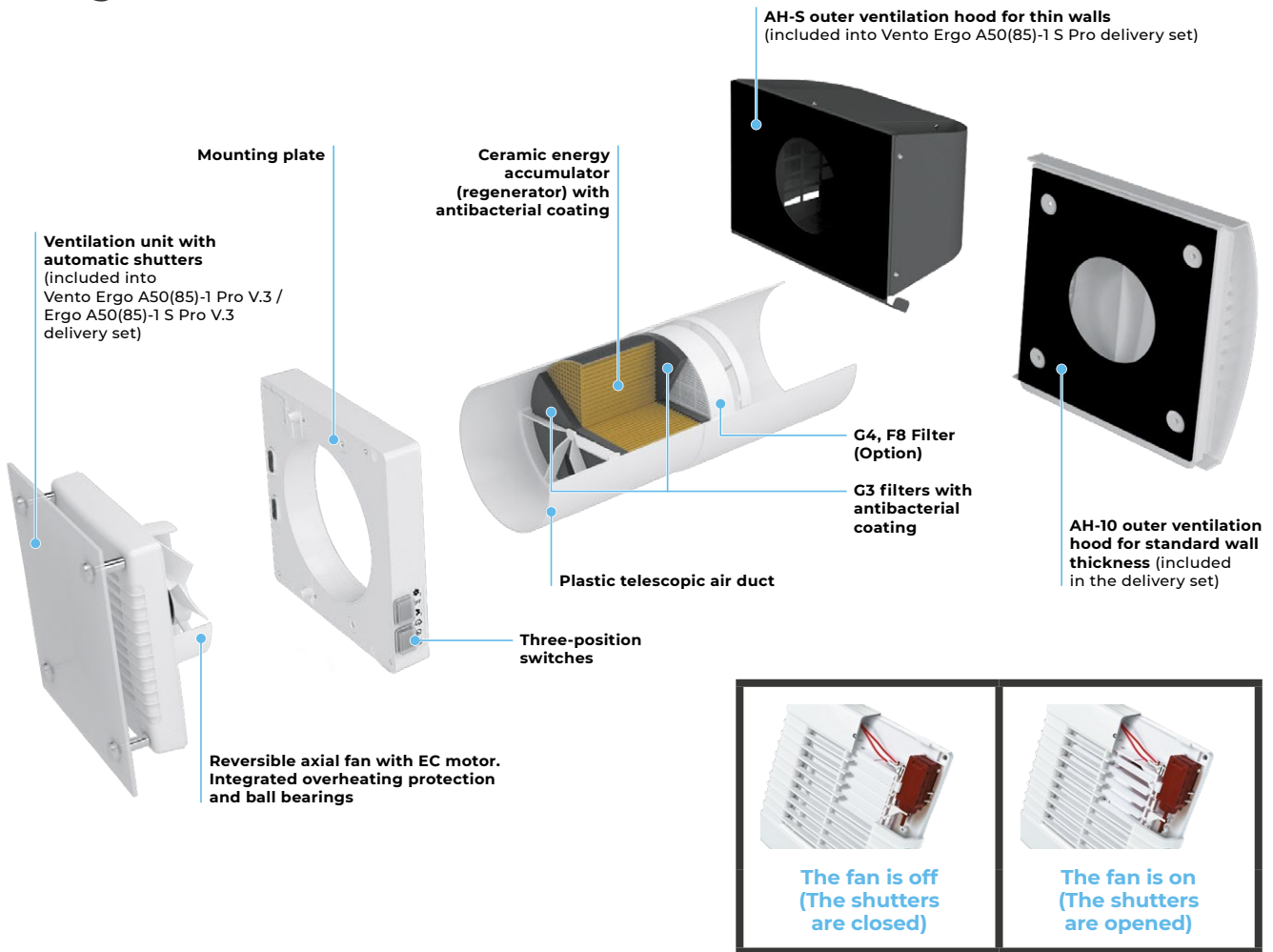

## Heat and humidity regeneration

High-tech ceramic energy accumulator with heat recovery up to 90 %.

Due to its cellular structure it has a larger heat transfer area surface and high efficiency.

### UNIT OPERATING LOGIC IN HOT SEASON

**Phase 1 (70 seconds)**  
Air extraction from the premise

**Phase 2 (70 seconds)**  
Air supply to the room



Cooled stale air is extracted from the premise, flows through the ceramic regenerator and transfers its heat energy and moisture to it. As the ceramic regenerator gets cooled down, the unit switches to the supply mode.

Clean hot intake air flows through the regenerator and absorbs accumulated heat and humidity. When the ceramic regenerator is warmed up, the unit switches to the extract air mode.

## Control

The unit operation mode control is performed by means of manual three-position switches located on the unit casing or using the remote controller.

Connection of the units into one ventilation system provide balanced ventilation and central control.

Remote control and operation mode selection:

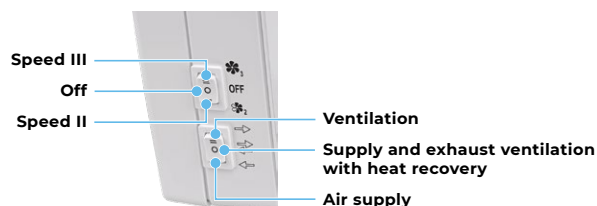

- Unit activation/deactivation:** The power button.
- 3 unit speeds:** Three buttons for different fan speeds.
- Passive air supply mode:** The automatic shutters are opened, the fan does not run.
- Ventilation mode:** The integrated units operate in permanent air supply or air extract mode depending on settings during mounting. The unit is set into air extract mode by default.
- Night mode:** In the night the unit is switched to low speed mode by the photo sensor.
- Air supply mode:** The unit operates in permanent air supply mode.
- Reversible ventilation with heat recovery:** The unit switches from supply to extract mode and vice versa in set time periods and transfers the heat and moisture contained in the extract air to cold intake air in winter or the coolness in summer through the ceramic heat exchanger.

Connection of several units in series enables their synchronous control by the first unit. The signal from the remote control is received by the first unit only.

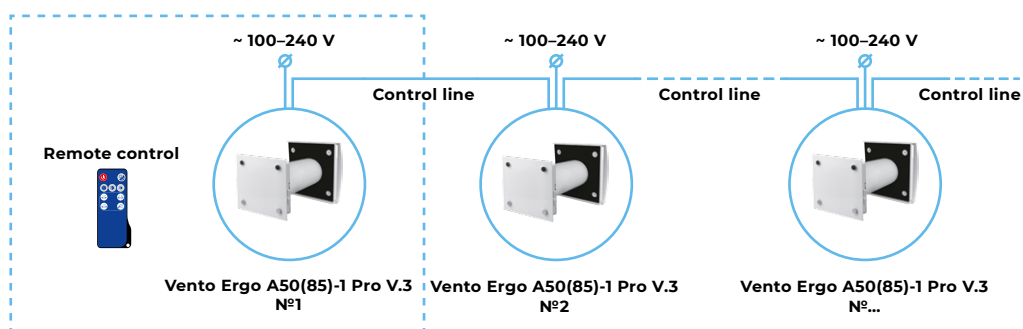

## Overall dimensions [mm]

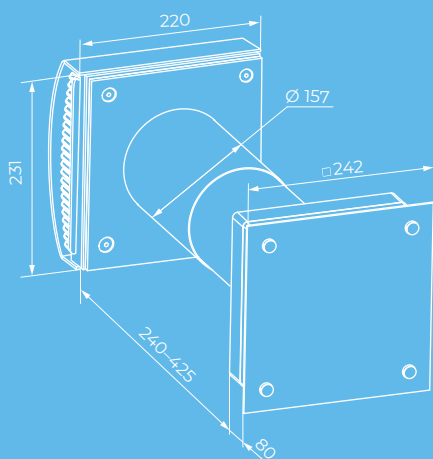

Vento Ergo A50(85)-1 Pro V.3

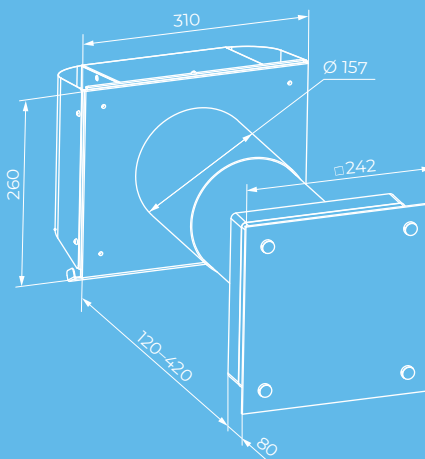

Vento Ergo A50(85)-1 S Pro V.3

## Mounting

The unit is designed for external through-the-wall installation inside a prepared round hole in the outer wall of the building.

The best ventilation solution is pairwise installation of reverse phase connected units. Some units supply fresh air to the room and the other units extract stale air from the room. This allows to arrange the most efficient balanced ventilation.

In case of brand new construction the units are mounted in two stages:

- **pre-installation** at the stage of the indoor finishing and outer decorative wall finishing. It includes installation of the telescopic air ducts, outer ventilation hood and laying out of electric cables.
- **final mounting** before commissioning of a house. It includes installation of the regenerator, the filters, connection of the ventilation unit.



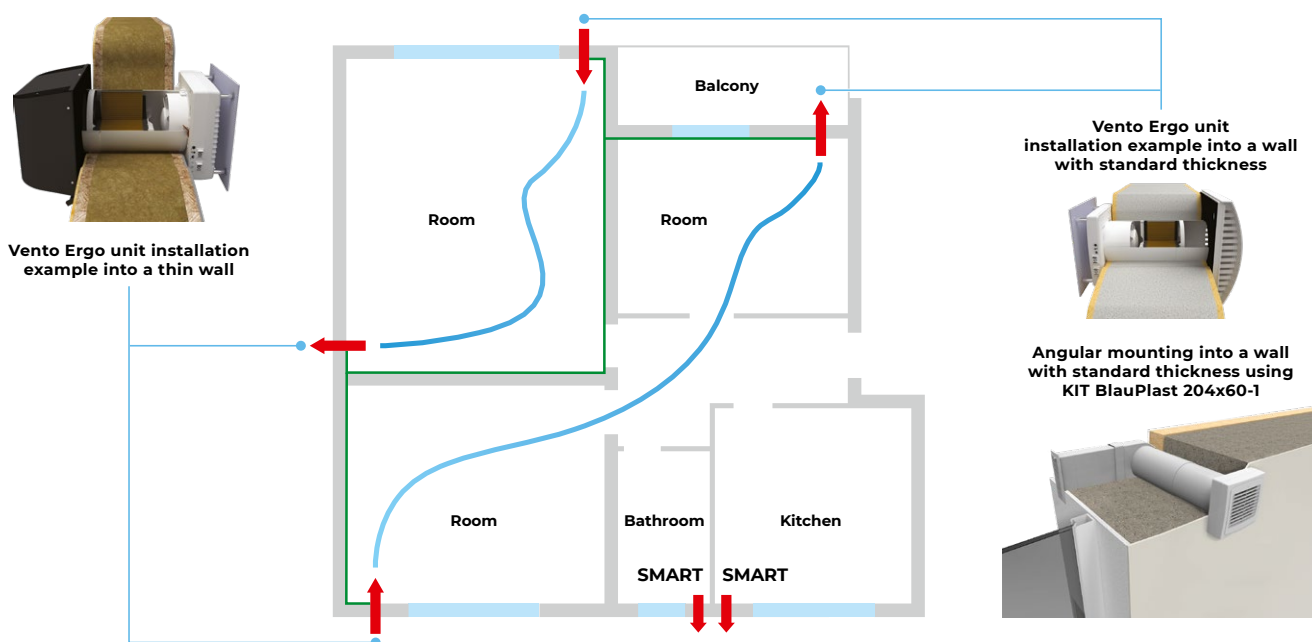











If mounting of the ventilation hood on the outer wall is undesirable it may be flush mounted and the external grille may be inserted into the outer window jamb using the **KIT BlauPlast 204x60-1** pre-installation kit. Available upon separate order.



## Technical data

Parameters	Vento Ergo A50-1 Pro V.3			Vento Ergo A85-1 Pro V.3		
Speed	I	II	III	I	II	III
Voltage [V / 50 (60) Hz]	1 ~ 100–240			1 ~ 100–240		
Power [W]	4.5	5	7	4.74	6.56	9.65
Current [A]	0.024	0.026	0.039	0.034	0.050	0.071
RPM [min <sup>-1</sup> ]	610	800	1450	1000	1500	2045
Maximum air flow [m <sup>3</sup> /h (l/s)]	20 (6)	35 (10)	50 (14)	36 (10)	59 (16)	85 (24)
Air flow in heat recovery mode [m <sup>3</sup> /h (l/s)]	10 (3)	18 (5)	25 (7)	18 (5)	30 (8)	43 (12)
SFP [W/l/s]	1.62	1.03	1.01	0.95	0.80	0.82
Filter	G3 (Option: G4, F8 PM2.5 > 99 %*)			G3 (Option: G4, F8 PM2.5 > 99 %*)		
Temperature exchange efficiency (heating) [%]	93	81	74	93	81	72
Temperature exchange efficiency (cooling) [%]	91	81	79	91	81	71
Enthalpy exchange efficiency (heating) [%]	90	73	65	90	73	59
Enthalpy exchange efficiency (cooling) [%]	84	74	62	84	74	60
Transported air temperature [°C]	-20...+40			-20...+40		
Ingress protection rating	IP24			IP24		

## Accessories

		Vento Ergo A50-1 Pro V.3	Vento Ergo A85-1 Pro V.3
<b>Pre-installation Kit Vento Ergo A50 S10 Pro</b>		Pre-installation kit for mounting into a wall with standard thickness. <b>Includes:</b> <ul style="list-style-type: none"> <li>• Round telescopic air duct with the diameter of 150 mm and adjustable length from 240 to 460 mm</li> <li>• AH-10 white 160 outer ventilation hood</li> <li>• Plastic foam plug</li> <li>• Plastic foam wedges</li> </ul>	
<b>Completion Kit Vento Ergo A50(85)-1 Pro V.3</b>		<b>Includes:</b> <ul style="list-style-type: none"> <li>• Ceramic regenerator Ø 150 mm</li> <li>• Vento Ergo A50-1 ventilation unit</li> <li>• G3 filters</li> <li>• Mounting plate</li> <li>• Remote control</li> </ul>	<b>Includes:</b> <ul style="list-style-type: none"> <li>• Ceramic regenerator Ø 150 mm</li> <li>• Vento Ergo A85-1 ventilation unit</li> <li>• G3 filters</li> <li>• Mounting plate</li> <li>• Remote control</li> </ul>
<b>FP Vento Ergo A50 G3</b>		G3 filters (2 pcs.)	
<b>FPC 150x50 G4</b>		G4 filter	
<b>FP Vento Ergo A50 F7</b>		F7 filter	
<b>AH-8 white 150</b>		White painted aluminium outer ventilation hood with frost protection for a cold climate	
<b>AH-8 chrome 150</b>		Brushed stainless steel outer ventilation hood with frost protection for a cold climate	
<b>AH-10 *colour* 160</b>		Plastic outer ventilation hood. Available in colours:	
<b>AH-10 chrome 160</b>		Plastic outer ventilation hood with a plate with brushed stainless steel effect finish	
<b>AH-S grey 150</b>		Outer ventilation hood for thin wall, painted grey	
<b>AH-S chrome 150</b>		Outer ventilation hood for thin wall made of brushed stainless steel	
<b>PP 160/0.5</b>		Outer ventilation hood for mounting from inside	
<b>KIT BlauPlast 204x60-1</b>		Installation kit for angular mounting. <b>Includes:</b> <ul style="list-style-type: none"> <li>• Plastic ventilation grille 230x86 mm</li> <li>• Plastic air duct 204x60 mm</li> <li>• Plastic connecting bend from Ø 150 to 204x60 mm</li> </ul>	
<b>FB Vento Ergo</b>		Remote control	



# VENTO EXPERT A30 S10 W V.2

## HEAT RECOVERY SINGLE-ROOM UNITS



up to  
**30 m<sup>3</sup>/h**



from  
**21 dBA**



up to  
**81 %**



## FEATURES

Arrangement of efficient energy-saving supply and exhaust single-room ventilation in flats, houses, cottages, social and commercial premises.

Reducing heat losses caused by ventilation due to heat recovery.

Wi-Fi communication between several single-room ventilation units for coordinated operation.

Controlled by Android or iOS smartphone or tablet.

## Designation key

Model	Air duct	Rated air flow [m <sup>3</sup> /h]	Ventilation hood type	Control
<b>Vento Expert</b>	<b>A:</b> round air duct	30	<b>S10:</b> white plastic hood AH-10 white 100	<b>W V.2:</b> control and setup of the unit with the Wi-Fi mobile application



## Design

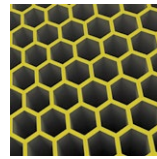
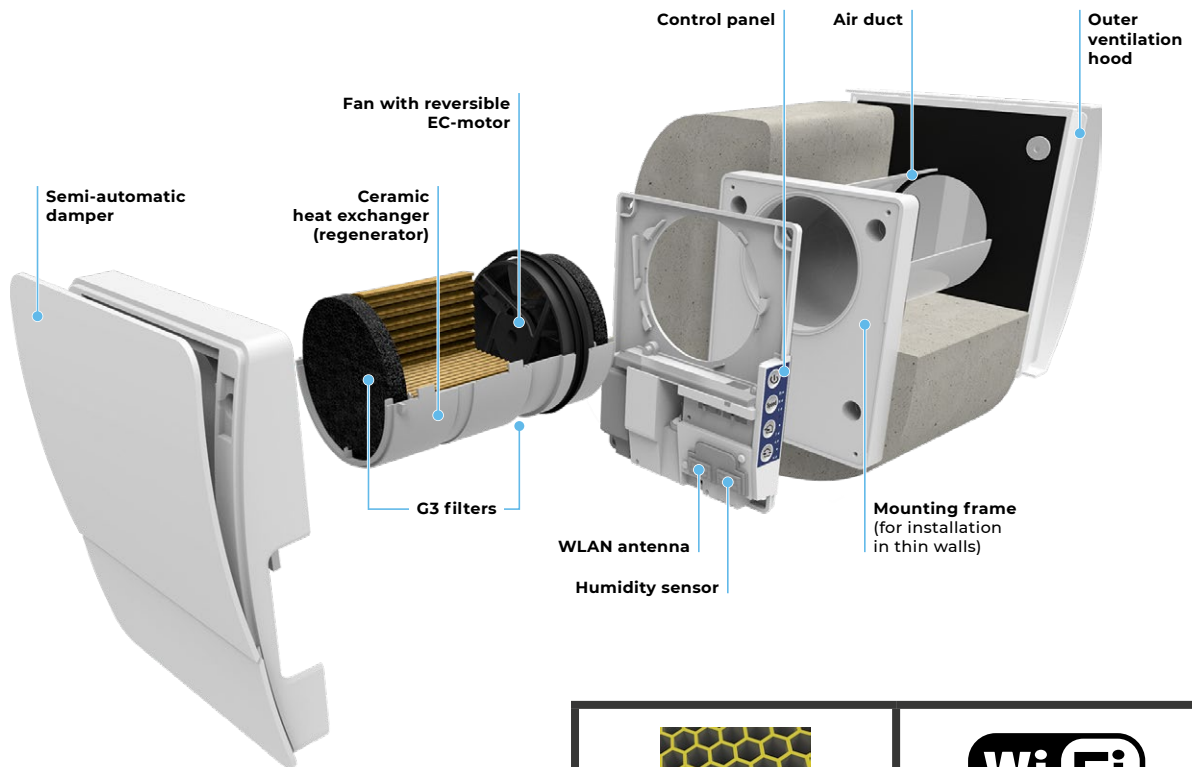

One of the best regeneration efficiency on the market due to innovative hexagonal structure of the heat exchanger cells



Built-in Wi-Fi for wireless communication between units and Android or iOS device control

## Heat recovery mode

### UNIT OPERATING LOGIC IN HOT SEASON

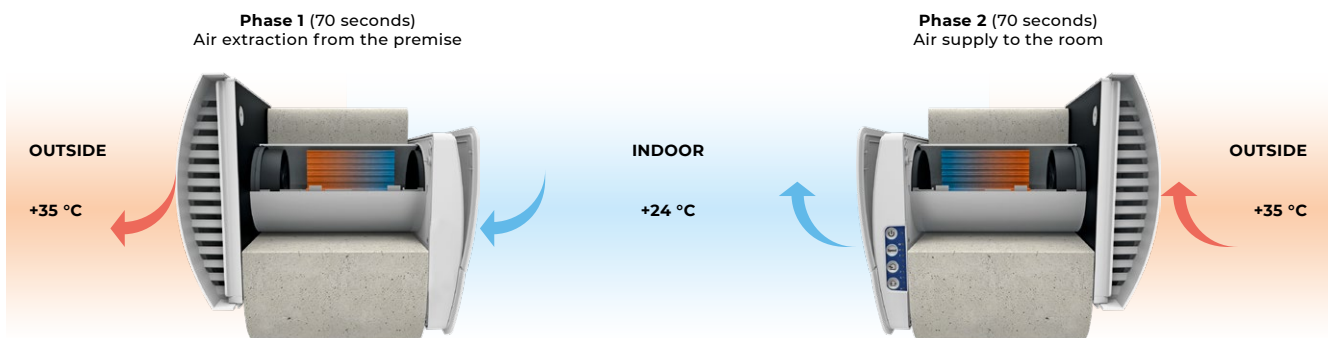

Cooled stale air is extracted from the premise, flows through the ceramic regenerator and transfers its heat energy and moisture to it. As the ceramic regenerator gets cooled down, the unit switches to the supply mode.

Clean hot intake air flows through the regenerator and absorbs accumulated heat and humidity. When the ceramic regenerator is warmed up, the unit switches to the extract air mode.

## Control

Control of the unit operation mode is performed by means of smartphone or tablet. Wi-Fi communication between several units for coordinated operation is available.



Download  
the Blaubeerg Home app  
for Android



Download  
the Blaubeerg Home app  
for iOS

## Mounting

The unit is designed for through-the-wall installation inside a prepared hole in an outer wall of the building.

The best ventilation solution is pairwise installation of reverse phase synchronized units. Some units ensure supply of fresh air to the room and the other units extract air from the premise. This way the most efficient balanced ventilation is arranged.

In case of brand new construction, units are mounted in two stages:

- **pre-installation** of an air duct and an outer ventilation hood at the stage of indoor finishing and outer decorative wall finishing;
- **completion of the installation** before commissioning of a house. It includes installation of the indoor unit with controller and air damper, the cartridge, the regenerator, the fan and the filters.

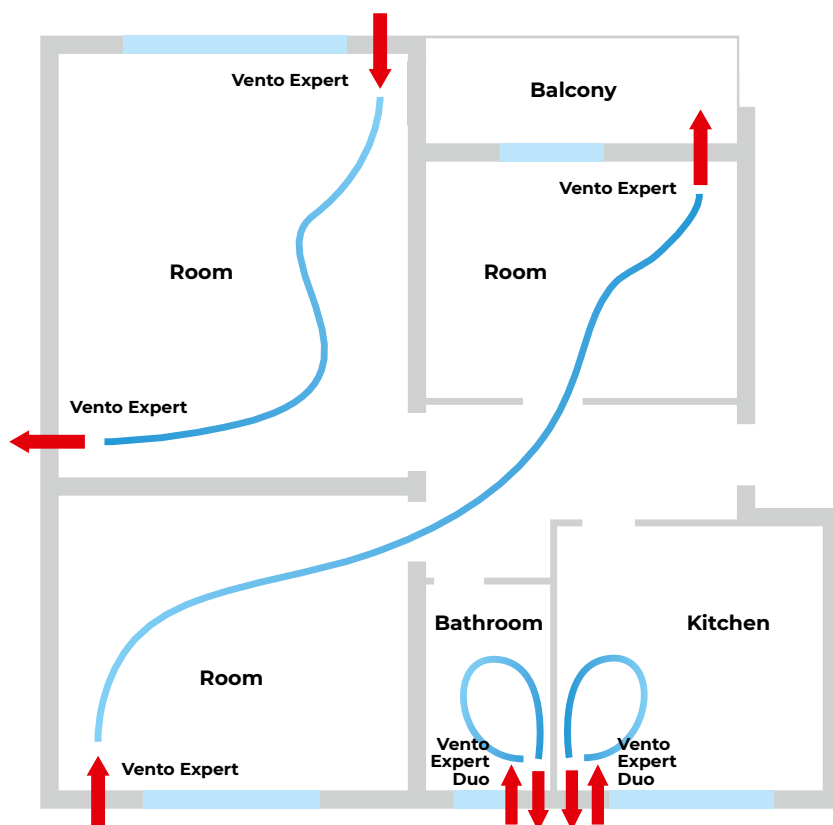

With mounting frame  
for thin walls



## Overall dimensions [mm]

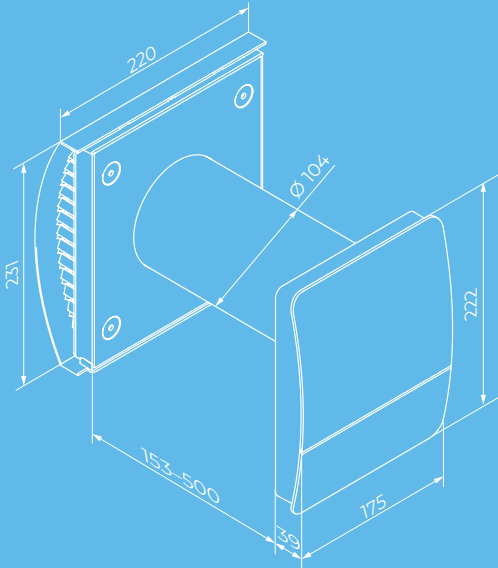



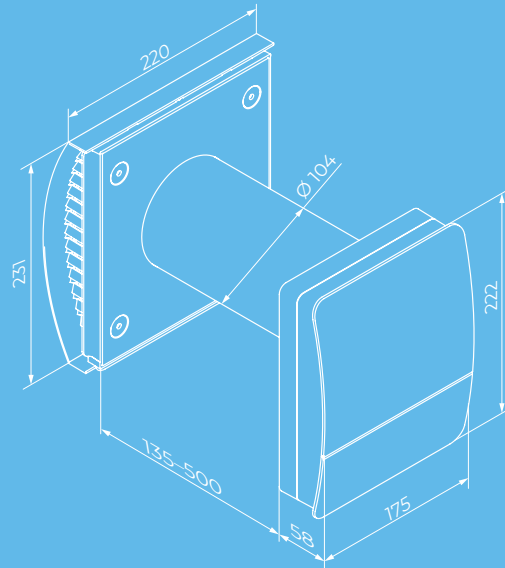









Vento Expert A30 S10 W V.2

Vento Expert A30 S10 W V.2  
(with a mounting frame for thin walls)

## Technical data

Parameters	Vento Expert A30 S10 W V.2		
Speed	I	II	III
Voltage [V / 50 (60) Hz]	100-240		
Power [W]	1.80	3.00	4.40
Current [A]	0.027	0.037	0.051
RPM [min <sup>-1</sup> ]	1600	2200	2500
Air flow in ventilation mode [m <sup>3</sup> /h (l/s)]	10 (3)	20 (6)	30 (8)
Air flow in heat recovery mode [m <sup>3</sup> /h (l/s)]	5 (1)	10 (3)	15 (4)
SFP [W/l/s]	1.30	1.08	1.06
Filter	G3		
Transported air temperature [°C]	-15...+40		
Sound pressure level at 1 m [dBA]	30	37	40
Sound pressure level at 3 m [dBA]	21	28	31
Outdoor sound pressure attenuation [dBA] in accordance with DIN EN 20140	42		
Indoor/outdoor airtightness classification of the complete unit in accordance with EN 13141-8	D1		
Temperature exchange efficiency (heating) [%]	81	73	66
Temperature exchange efficiency (cooling) [%]	78	73	68
Enthalpy exchange efficiency (heating) [%]	77	65	54
Enthalpy exchange efficiency (cooling) [%]	71	66	51
Ingress protection rating	IP24		

## Accessories

		Description
<b>Pre-installation Kit Vento Expert A30 S10</b>		Pre-installation kit for mounting into a wall with standard thickness. <b>Includes:</b> <ul style="list-style-type: none"> <li>• Air duct</li> <li>• AH-10 white 100 outer ventilation hood</li> <li>• Plastic foam plug</li> <li>• Plastic foam wedges</li> </ul>
<b>Completion Kit Vento Expert A30 W V.2</b>		Final mounting kit. <b>Includes:</b> <ul style="list-style-type: none"> <li>• Cartridge with a heat regenerator, a fan and G3 filters</li> <li>• Indoor unit with a controller and air damper</li> </ul>
<b>FP3 Vento G3</b>		G3 filters (2 pcs.)
<b>AH-10 *colour* 100</b>		Plastic outer ventilation hood. Available in colours: 
<b>AH-10 chrome 100</b>		Plastic outer ventilation hood with a plate with brushed stainless steel effect finish
<b>KIT BlauPlast white 100</b>		Kit for angular mounting with white colour grille (for walls with standard thickness)
<b>KIT BlauPlast chrome 100</b>		Kit for angular mounting with stainless steel outer grille (for walls with standard thickness)
<b>SE Vento Expert W</b>		Sensor control panel
<b>CD-1</b>		CO <sub>2</sub> sensor with LED CO <sub>2</sub> indication and a sensor button for operation mode selection
<b>CD-2</b>		CO <sub>2</sub> sensor
<b>S Vento Expert A30</b>		Cardboard template for indoor installation of the unit



# VENTO EXPERT

## A50(85)-1 C1 W V.3

### HEAT RECOVERY SINGLE-ROOM UNITS



up to  
**85** m<sup>3</sup>/h



from  
**4** dBA



up to  
**95** %



## FEATURES

Arrangement of efficient energy-saving, supply and exhaust, single-room ventilation in flats, houses, cottages, social and commercial premises.

Reducing heat losses caused by ventilation due to heat recovery.

Reduce the heating costs in winter and air conditioning costs in summer.

Wi-Fi data exchange between several single-room ventilation units for coordinated operation.





Controlled by Android or iOS smartphone or tablet.

## Designation key

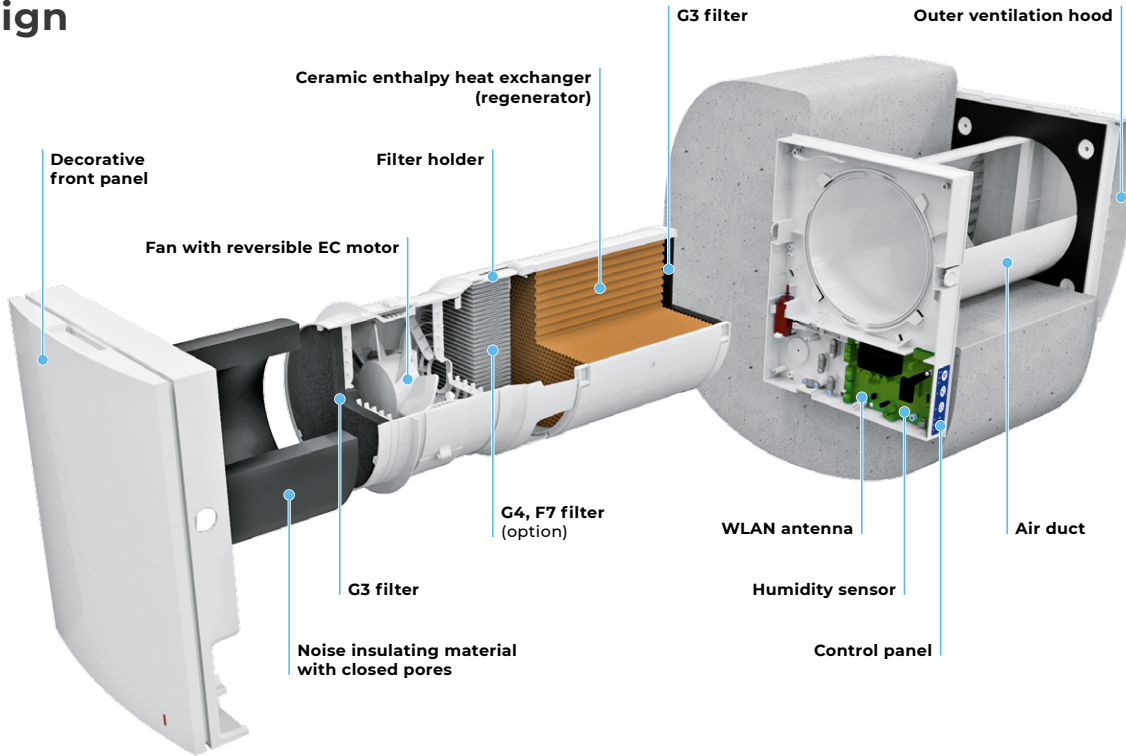
Model	Air duct	Rated air flow [m <sup>3</sup> /h]	Front panel	Ventilation hood type	Control
Vento Expert	<b>A:</b> round air duct	50; 85	<b>-1:</b> flat front panel	<b>_:</b> white plastic hood AH-10 white 160 (for standard walls) <b>S:</b> metal hood (for thin walls)	<b>W V.3:</b> Control and setup of the unit with the Wi-Fi mobile application

## Design



 <p>One of the best regeneration efficiency on the market due to innovative hexagonal structure of the heat exchanger cells</p>	 <p>Built-in Wi-Fi for wireless communication between units and Android or iOS device control</p>	 <p>Integrated automatic air shutters prevent air back drafting</p>	 <p>The specially designed front panel can be closed manually to ensure 100 % air tightness and protect against wind impact</p>	 <p>The demountable design of the regenerator cartridge improves heat recovery efficiency and simplifies maintenance</p>
--	--	--	---	---

## Heat recovery mode

### UNIT OPERATING LOGIC IN HOT SEASON

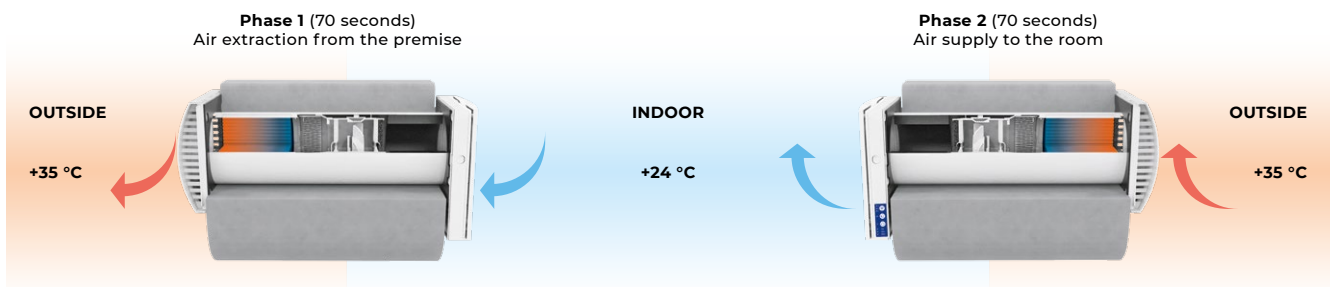

Cooled stale air is extracted from the premise, flows through the ceramic regenerator and transfers its heat energy and moisture to it. As the ceramic regenerator gets cooled down, the unit switches to the supply mode.

Clean hot intake air flows through the regenerator and absorbs accumulated heat and humidity. When the ceramic regenerator is warmed up, the unit switches to the extract air mode.

## Control

Unit control via smartphone or tablet application.

The units can be connected via Wi-Fi for synchronized operation.

House ventilation control via cloud service from anywhere in the world.

Connection to smart house or Building Management System (BMS) via Wi-Fi.



Download  
the Blaubeerg Home app  
for Android



Download  
the Blaubeerg Home app  
for iOS

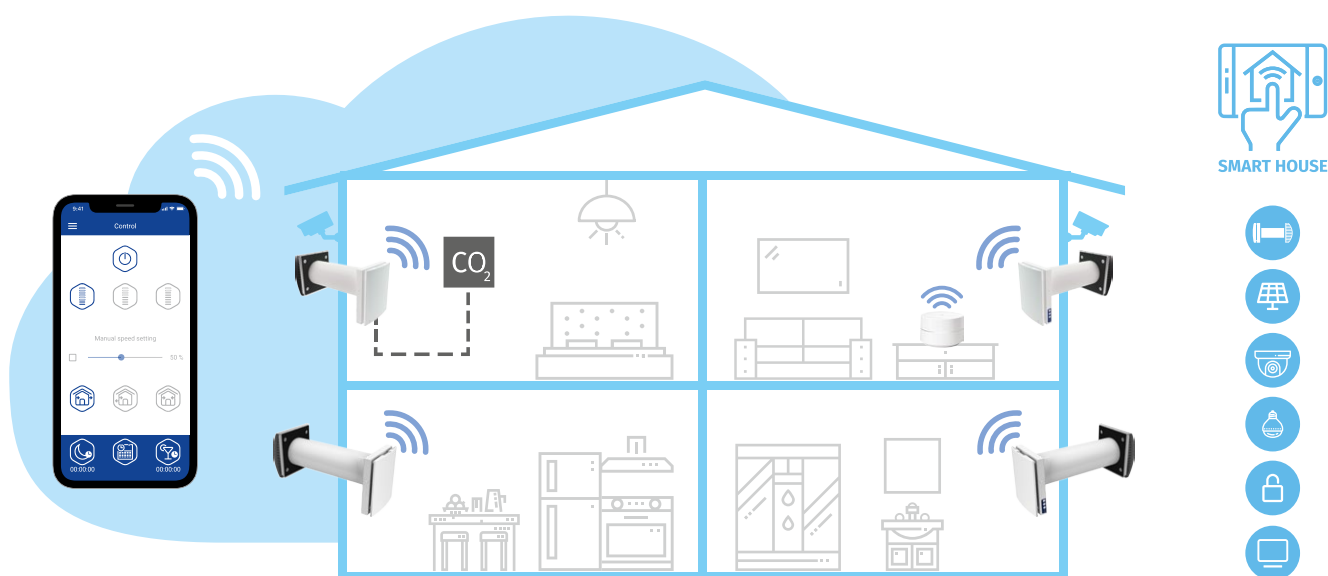

**Vento Expert A50(85)-1 W V.3** either can operate as independent unit or can be connected with other units in a house and controlled with a master unit. In this case, only the master unit receives a signal from the remote control.

### FOR LIVING ROOMS AND BEDROOMS



### FOR KITCHEN AND BATHROOM



Control of the unit operation mode is also performed by means of the sensor control panel located on the unit casing or the remote control.

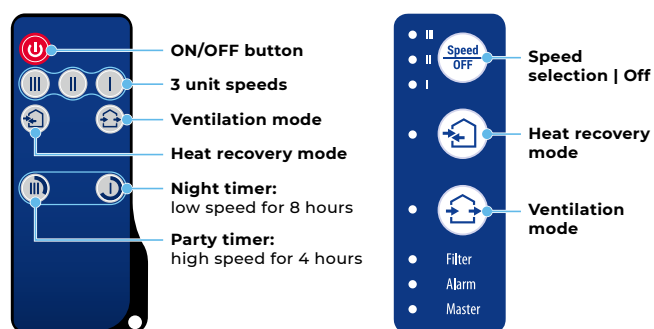

**Vento Expert** is equipped with a humidity sensor for indoor humidity control. If humidity increases above a set point, the unit boosts to the speed III.



## Mounting

The unit is designed for through-the-wall installation inside a prepared hole in an outer wall of the building.

The best ventilation solution is pairwise installation of reverse phase synchronized units. Some units ensure supply of fresh air to the room and the other units extract air from the premise. This way the most efficient balanced ventilation is arranged.

In case of brand new construction, units are mounted in two stages:

- **pre-installation** of an air duct and an outer ventilation hood at the stage of indoor finishing and outer decorative wall finishing;
- **completion of the installation** before commissioning of a house. It includes installation of the indoor unit with controller and shutters the cartridge, the heat exchanger, the fan and the filters.

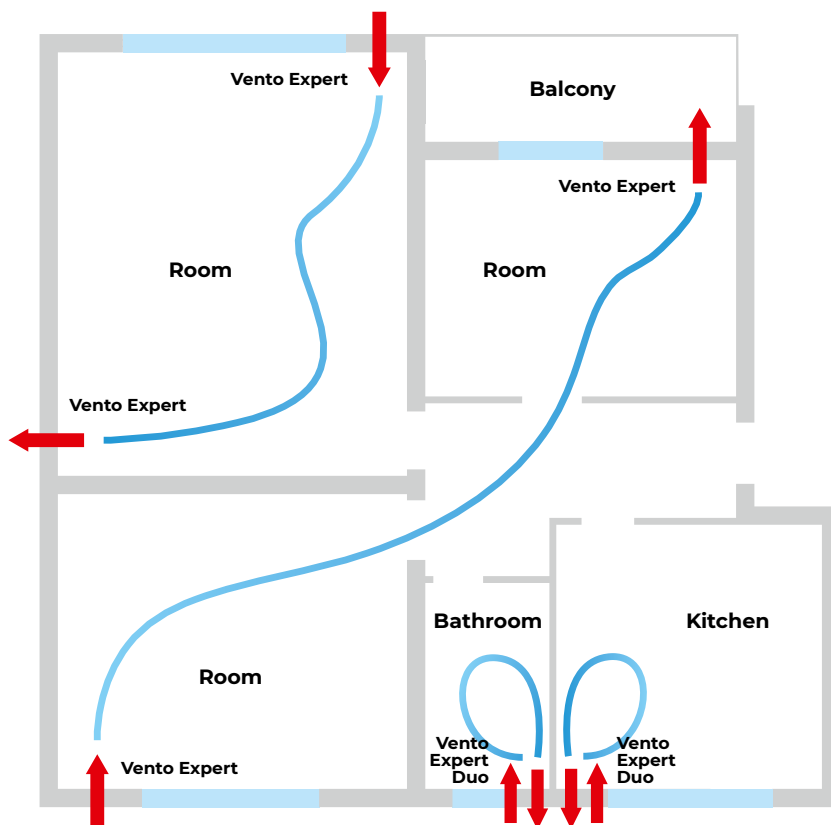

Unit installation example with the hood for thin walls AH-S grey 160 / AH-S chrome 160

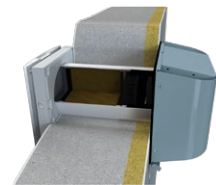

Angular mounting into a wall with standard thickness using KIT BlauPlast white 160 / KIT BlauPlast chrome 160



## Overall dimensions [mm]

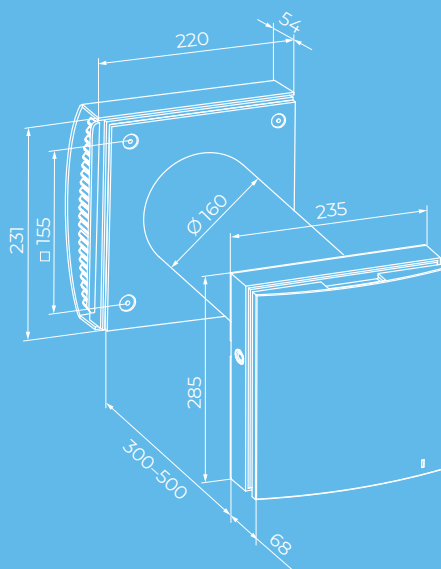



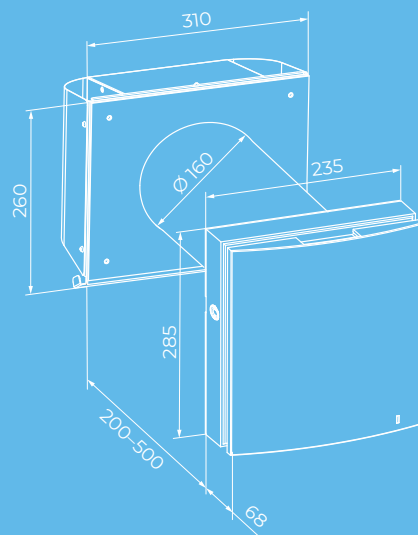

Vento Expert A50(85)-1 C1 W V.3

















 Vento Expert A50(85)-1 C1 S W V.3  
(for thin walls)

## Technical data

Parameters	Vento Expert A50-1 C1 W V.3			Vento Expert A85-1 C1 W V.3			
<b>Speed</b>	I	II	III	I	II	III	MAX
<b>Voltage [V / 50 (60) Hz]</b>	100-240			100-240			
<b>Power [W]</b>	4.45	5.08	7.06	3.78	4.71	6.85	10.55
<b>Current [A]</b>	0.035	0.040	0.059	0.048	0.056	0.075	0.106
<b>RPM [min<sup>-1</sup>]</b>	800	1300	1900	1050	1600	2270	2930
<b>Air flow in ventilation mode [m<sup>3</sup>/h (l/s)]</b>	15 (4)	30 (8)	50 (14)	15 (4)	30 (8)	50 (14)	65 (18)
<b>Air flow in heat recovery mode [m<sup>3</sup>/h (l/s)]</b>	8 (2)	15 (4)	25 (7)	8 (2)	15 (4)	25 (7)	33 (9)
<b>SFP [W/l/s]</b>	2.14	1.22	1.02	1.81	1.13	0.99	1.17
<b>Filter</b>	G3 (G4, F7 optional)			G3, F8			
<b>Transported air temperature [°C]</b>	-20...+40			-20...+40			
<b>Sound pressure level at 1 m [dBA]</b>	20	27	30	26	36	45	50
<b>Sound pressure level at 3 m [dBA]</b>	11	18	21	16	27	36	40
<b>Temperature exchange efficiency (heating) [%]</b>	93	81	74	92	84	77	72
<b>Temperature exchange efficiency (cooling) [%]</b>	91	81	79	89	84	79	71
<b>Enthalpy exchange efficiency (heating) [%]</b>	90	73	65	88	76	65	59
<b>Enthalpy exchange efficiency (cooling) [%]</b>	84.0	74.0	62.0	82	77	62	60
<b>F7 Filtration rate PM 2.5 [%]</b>	99			99			
<b>Airflow with F7 [m<sup>3</sup>/h (l/s)]</b>	40			65			
<b>Ingress protection rating</b>	IP24			IP24			

## Accessories

		Description
<b>Pre-installation Kit Vento Expert A50-1</b>		Pre-installation kit for mounting into walls with standard thickness. <b>Includes:</b> <ul style="list-style-type: none"> <li>• Air duct</li> <li>• AH-10 white 160 outer ventilation hood</li> <li>• Polystyrene foam plug</li> <li>• Polystyrene foam wedges</li> </ul>
<b>Pre-installation Kit Vento Expert A50-1 S</b>		Pre-installation kit for mounting into thin walls. <b>Includes:</b> <ul style="list-style-type: none"> <li>• Air duct</li> <li>• AH-S chrome 160 outer ventilation hood</li> <li>• Polystyrene foam plug</li> <li>• Polystyrene foam wedges</li> </ul>
<b>Completion Kit Vento Expert A50-1 W V.3</b>		Final mounting kit. <b>Includes:</b> <ul style="list-style-type: none"> <li>• Regenerator module</li> <li>• Fan module</li> <li>• G3 filters (2 pcs.)</li> <li>• Indoor unit with a controller and shutters</li> <li>• Remote control</li> </ul>
<b>FP2 Vento G3</b>		G3 filters (2 pcs.)
<b>FP2 Vento G4</b>		Coarse filter. <b>Includes:</b> <ul style="list-style-type: none"> <li>• Plastic filter holder (1 pc.)</li> <li>• G4 filter (1 pc.).</li> </ul>
<b>FPC 150x50 G4</b>		G4 coarse filter
<b>FP2 Vento F7</b>		Filter set. <b>Includes:</b> <ul style="list-style-type: none"> <li>• Plastic filter holder (1 pc.)</li> <li>• F7 fine filter (1 pc.). Filtration rate PM2.5 &gt; 70 %</li> </ul>
<b>FPC 150x50 F7</b>		F7 fine filter. Filtration rate PM2.5 > 70 %
<b>AH-8 white 160</b>		White painted aluminium outer ventilation hood with frost protection for a cold climate
<b>AH-8 chrome 160</b>		Brushed stainless steel outer ventilation hood with frost protection for a cold climate
<b>AH-10 *colour* 160</b>		Plastic outer ventilation hood. Available in colours: <div style="display: flex; justify-content: space-around; align-items: center;"> <div style="text-align: center;"> white</div> <div style="text-align: center;"> black</div> <div style="text-align: center;"> grey</div> <div style="text-align: center;"> terracotta</div> <div style="text-align: center;"> brown</div> <div style="text-align: center;"> vintage</div> </div>
<b>AH-10 chrome 160</b>		Plastic outer ventilation hood with a plate with brushed stainless steel effect finish

		Description
<b>AH-11 *colour* 160</b>		Plastic outer ventilation hood. Available in colours:       white black grey terracotta brown vintage
<b>AH-S white 160</b>		Stainless steel ventilation hood, painted white
<b>AH-S chrome 160</b>		Brushed stainless steel ventilation hood
<b>PP 160/0.5</b>		Outer ventilation hood for mounting from inside
<b>KIT BlauPlast white 160</b>		Kit for angular mounting with white colour grille (for walls with standard thickness)
<b>KIT BlauPlast chrome 160</b>		Kit for angular mounting with stainless steel outer grille (for walls with standard thickness)
<b>SE Vento Expert W</b>		Sensor control panel
<b>FB Vento Expert A50</b>		Remote control
<b>CD-1</b>		CO <sub>2</sub> sensor with LED CO <sub>2</sub> indication and a sensor button for operation mode selection
<b>CD-2</b>		CO <sub>2</sub> sensor
<b>S Vento Expert A50</b>		Cardboard template for indoor installation of the unit



# VENTO EXPERT A50(85)-1 C1 S10 PRO

## HEAT RECOVERY SINGLE-ROOM UNITS



up to  
**85** m<sup>3</sup>/h



from  
**4** dBA



up to  
**95** %



## FEATURES

Arrangement of efficient energy-saving, supply and exhaust, single-room ventilation in flats, houses, cottages, social and commercial premises.

Reducing heat losses caused by ventilation due to heat recovery.

Reduce the heating costs in winter and air conditioning costs in summer.

Wi-Fi data exchange between several single-room ventilation units for coordinated operation.





Controlled by Android or iOS smartphone or tablet.

## Designation key

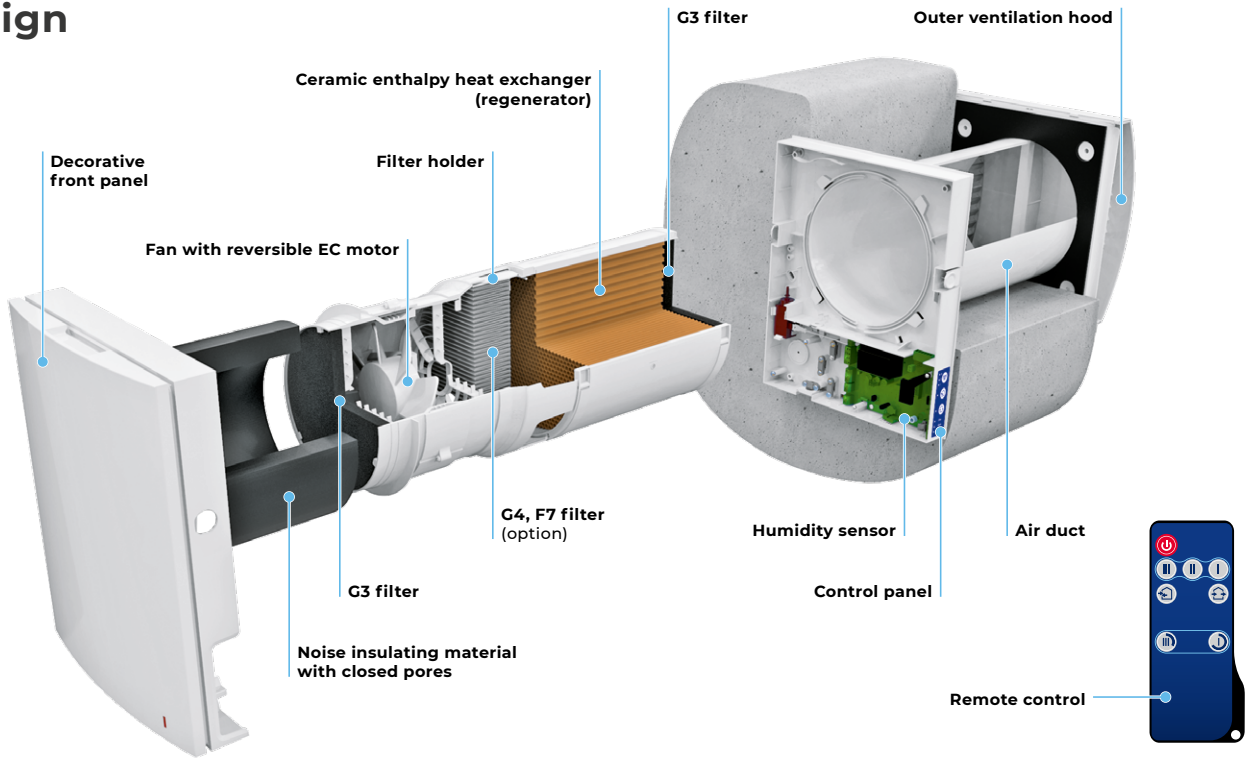
Model	Air duct	Rated air flow [m <sup>3</sup> /h]	Front panel	Ventilation hood type	Control
Vento Expert	<b>A:</b> round air duct	50; 85	<b>-1:</b> flat front panel	<b>_:</b> white plastic hood AH-10 white 160 (for standard walls) <b>S:</b> metal hood for thin walls	<b>Pro V.3:</b> control with touch buttons and a remote control

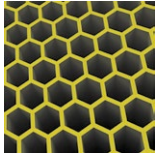
## Design



 <p>Easy maintenance. Indoor unit is opened by pressing the latches on both sides</p>	 <p>One of the best regeneration efficiency on the market due to innovative hexagonal structure of the heat exchanger cells</p>	 <p>Integrated automatic air shutters prevent air back drafting</p>	 <p>The specially designed front panel can be closed manually to ensure 100 % air tightness and protect against wind impact</p>	 <p>The demountable design of the regenerator cartridge improves heat recovery efficiency and simplifies maintenance</p>
--	--	--	---	---

## Heat recovery mode

### UNIT OPERATING LOGIC IN HOT SEASON

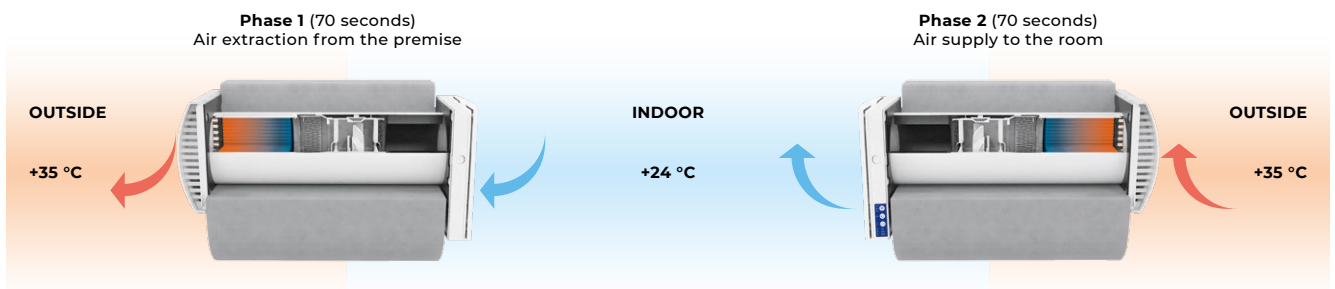

Cooled stale air is extracted from the premise, flows through the ceramic regenerator and transfers its heat energy and moisture to it. As the ceramic regenerator gets cooled down, the unit switches to the supply mode.

Clean hot intake air flows through the regenerator and absorbs accumulated heat and humidity. When the ceramic regenerator is warmed up, the unit switches to the extract air mode.

## Control

Control of the unit operation mode is performed by means of sensor control panel located on the unit casing or a remote controller.

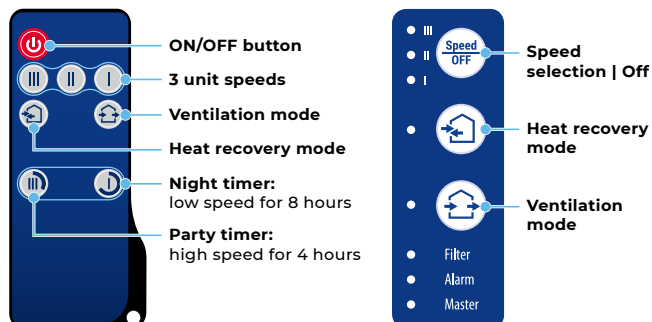

**Vento Expert** is equipped with a humidity sensor for indoor humidity control. If humidity increases above a set point, the unit boosts to the speed III or this feature can be disabled.

**Vento Expert** either can operate as independent unit or can be connected with other units in a house and controlled with a master unit. In this case, only the master unit receives a signal from the remote control.

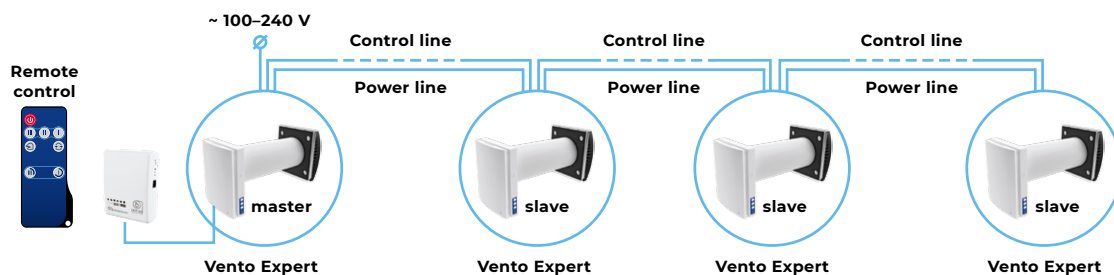

## Mounting

The unit is designed for through-the-wall installation inside a prepared hole in an outer wall of the building.

The best ventilation solution is pairwise installation of reverse phase connected units. Some units ensure supply of fresh air to the room and the other units extract air from the premise. This way the most efficient balanced ventilation is arranged.

In case of brand new construction, units are mounted in two stages:

- **pre-installation** at the stage of the indoor finishing and outer decorative wall finishing. It includes installation of an air duct, an outer ventilation hood and cable installation;
- **final mounting** before commissioning of a house. It includes installation of a regenerator with a fan and filters and mounting and wiring of an indoor unit with a controller and shutters.

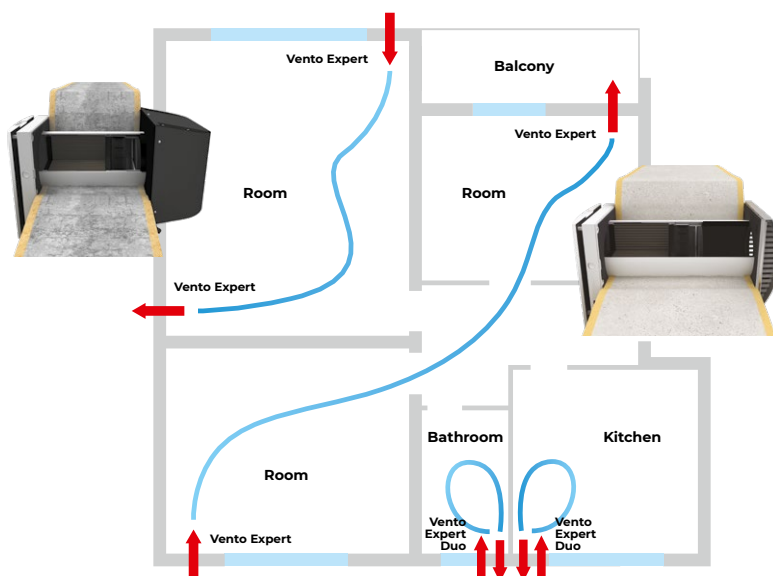

Angular mounting into a wall with standard thickness using  
KIT BlauPlast white 160 /  
KIT BlauPlast chrome 160





## Overall dimensions [mm]

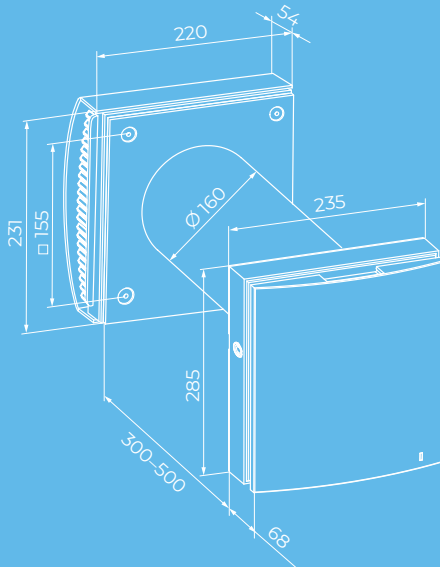

Vento Expert A50(85)-1 C1 Pro V.3

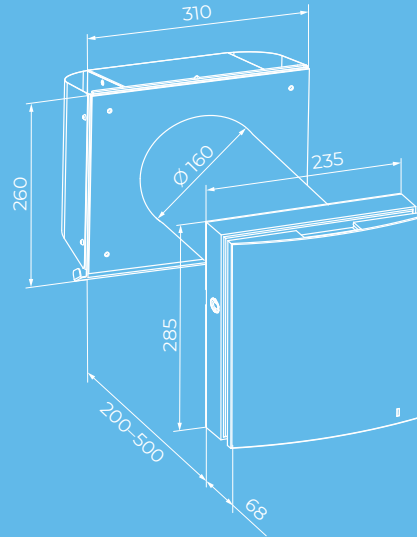













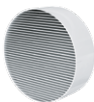



















Vento Expert A50(85)-1 C1 S Pro V.3  
(for thin walls)

## Technical data

Parameters	Vento Expert A50-1 C1 Pro			VentoExpert A85-1 Pro			
<b>Speed</b>	I	II	III	I	II	III	MAX
<b>Voltage [V / 50 (60) Hz]</b>	100-240			100-240			
<b>Power [W]</b>	4.45	5.08	7.06	3.78	4.71	6.85	10.55
<b>Current [A]</b>	0.035	0.040	0.059	0.048	0.056	0.075	0.106
<b>RPM [min<sup>-1</sup>]</b>	800	1300	1900	1050	1600	2270	2930
<b>Air flow in ventilation mode [m<sup>3</sup>/h (l/s)]</b>	15 (4)	30 (8)	50 (14)	15 (4)	30 (8)	50 (14)	65 (18)
<b>Air flow in heat recovery mode [m<sup>3</sup>/h (l/s)]</b>	8 (2)	15 (4)	25 (7)	8 (2)	15 (4)	25 (7)	33 (9)
<b>SFP [W/l/s]</b>	2.14	1.22	1.02	1.81	1.13	0.99	1.17
<b>Filter</b>	G3 (G4, F7 optional)			G3, F8			
<b>Transported air temperature [°C]</b>	-20...+40			-20...+40			
<b>Sound pressure level at 1 m [dBA]</b>	20	27	30	26	36	45	50
<b>Sound pressure level at 3 m [dBA]</b>	11	18	21	16	27	36	40
<b>Temperature exchange efficiency (heating) [%]</b>	94	81	74	92	84	77	72
<b>Temperature exchange efficiency (cooling) [%]</b>	91	81	79	89	84	79	71
<b>Enthalpy exchange efficiency (heating) [%]</b>	90	73	65	88	76	65	59
<b>Enthalpy exchange efficiency (cooling) [%]</b>	84	74	62	82	77	62	60
<b>F7 Filtration rate PM 2.5 [%]</b>	99			99			
<b>Airflow with F7 [m<sup>3</sup>/h (l/s)]</b>	40			65			
<b>Ingress protection rating</b>	IP24			IP24			

## Accessories

		Description
<b>Pre-installation Kit Vento Expert A50-1</b>		Pre-installation kit for mounting into a wall with standard thickness. <b>Includes:</b> <ul style="list-style-type: none"> <li>• Air duct</li> <li>• AH 160 outer ventilation hood</li> <li>• Plastic foam plug</li> <li>• Plastic foam wedges</li> </ul>
<b>Pre-installation Kit Vento Expert A50-1 S</b>		Pre-installation kit for mounting into a thin wall. <b>Includes:</b> <ul style="list-style-type: none"> <li>• Air duct</li> <li>• AH-S chrome 160 outer ventilation hood</li> <li>• Plastic foam plug</li> <li>• Plastic foam wedges</li> </ul>
<b>Completion Kit Vento Expert A50-1 Pro V.3</b>		Final mounting kit. <b>Includes:</b> <ul style="list-style-type: none"> <li>• Regenerator module</li> <li>• Fan module</li> <li>• G3 filters (2 pcs.)</li> <li>• Indoor unit with a controller and shutters</li> <li>• Remote control</li> </ul>
<b>FP2 Vento G3</b>		G3 filters (2 pcs.)
<b>FP2 Vento G4</b>		Coarse filter. <b>Includes:</b> <ul style="list-style-type: none"> <li>• Plastic filter holder (1 pc.)</li> <li>• G4 filter (1 pc.)</li> </ul>
<b>FPC 150x50 G4</b>		G4 coarse filter
<b>FP2 Vento F7</b>		Filter set. <b>Includes:</b> <ul style="list-style-type: none"> <li>• Plastic filter holder (1 pc.)</li> <li>• F7 fine filter (1 pc.). Filtration rate PM2.5 &gt; 70 %</li> </ul>
<b>FPC 150x50 F7</b>		F7 fine filter. Filtration rate PM2.5 > 70 %
<b>AH-8 white 160</b>		White painted aluminium outer ventilation hood with frost protection for a cold climate
<b>AH-8 chrome 160</b>		Brushed stainless steel outer ventilation hood with frost protection for a cold climate
<b>AH-10 *colour* 160</b>		Plastic outer ventilation hood. Available in colours:      

Description		
<b>AH-10 chrome 160</b>		Plastic outer ventilation hood with a plate with brushed stainless steel effect finish
<b>AH-11 *colour* 160</b>		Plastic outer ventilation hood. Available in colours:  white  black  grey  terracotta  brown  vintage
<b>AH-S chrome 160</b>		Outer ventilation hood for thin wall made of brushed stainless steel
<b>AH-S grey 160</b>		Outer ventilation hood for thin wall, painted grey
<b>PP 160/0.5</b>		Outer ventilation hood for mounting from inside
<b>KIT BlauPlast white 160</b>		Kit for angular mounting with white colour grille (for walls with standard thickness)
<b>KIT BlauPlast chrome 160</b>		Kit for angular mounting with stainless steel outer grille (for walls with standard thickness)
<b>FB-Vento Expert</b>		Remote control
<b>CD-1</b>		CO <sub>2</sub> sensor with LED CO <sub>2</sub> indication and a sensor button for operation mode selection
<b>CD-2</b>		CO <sub>2</sub> sensor



# SOLO S4 PRO R V.2

## WALL VENTS



up to  
**60 m<sup>3</sup>/h**



from  
**21 dBA**



up to  
**85 %**



## FEATURES

Wall ventilator with heat and energy recovery.

Supply clean fresh air to the premises.

Control via remote control.

Remove stale extract air from the premise.

Clean the air of dust and insects.

Protect against outdoor noise.

Heat return and ensuring the balance of humidity in the room thanks to the built-in humidity sensor.

Reduce the heating costs in winter and air conditioning costs in summer.

Low energy demand.

## Design

### FAN

Air is supplied or extracted by a reversible axial fan with EC motor. Due to EC technology the fan is distinguished with low energy demand. The motor has overheating protection and ball bearings for longer service life.

### AIR FILTERS

Two built-in filters with total filter class G3 are used to clean supply and extract air flows. The filters ensure fresh air cleaning of dust and insects and prevent the ventilator parts from soiling. The filters are cleaned either with a vacuum cleaner or flushed with water.

### ENERGY HEAT EXCHANGER

The high-technology ceramic energy heat exchanger with recovery efficiency up to 85 % is used for extract air heat energy recovery and supply air heating.

### HUMIDITY SENSOR

Helps control the level of humidity in the room. When the sensor is activated, if the humidity in the room exceeds the set level, the ventilator switches to the second (higher) speed. The humidity sensor threshold can be adjusted by turning the potentiometer knob with a special plastic screwdriver. The humidity sensor can be switched on and off using the remote control.

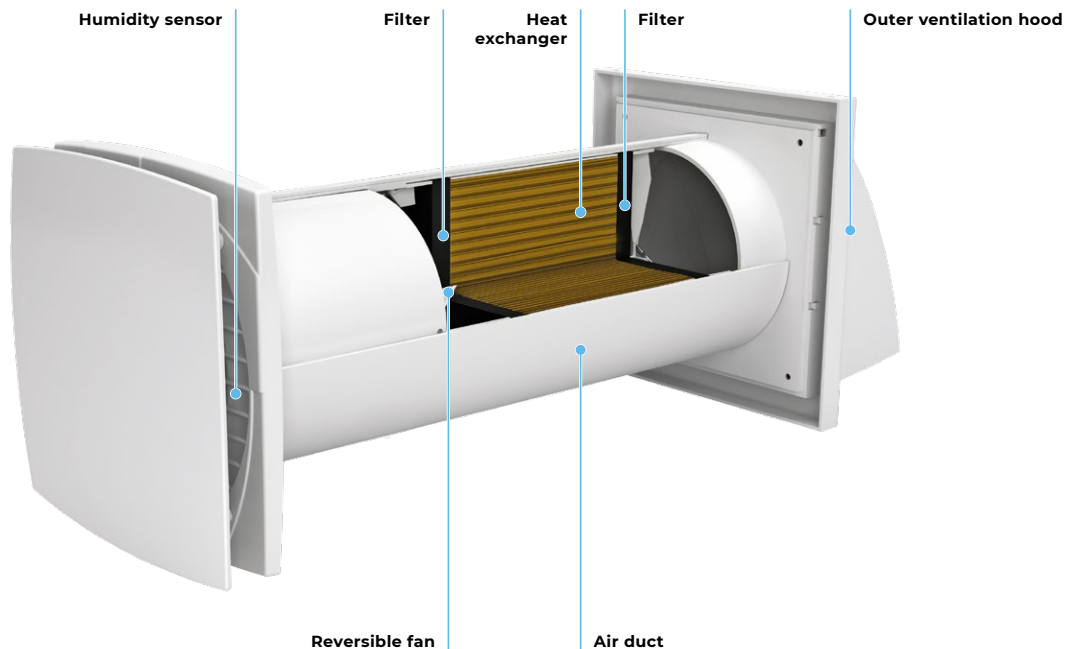

## Operation logic

Energy is recovered due to reversing operation of the ventilator, which consists of two cycles:

**CYCLE I.** As warm stale extract air flows through the ceramic heat exchanger, it heats up and moisturizes the heat exchanger. In 60 seconds as the ceramic heat exchanger gets warmed the ventilator automatically switches to Air Supply mode.

**CYCLE II.** Fresh, cold intake air from outside flows through the ceramic heat exchanger, absorbs accumulated moisture and is heated to the room temperature. In 60 seconds as the heat exchanger gets cooled down, the ventilator switches to Air Extract mode and the cycle is renewed.

The Air Supply and the Air Extract modes are switched every 60 seconds.

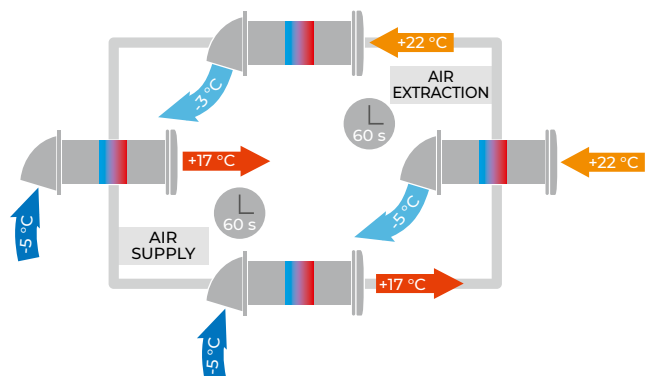

## Control

The humidity sensor and speed are controlled by the remote control.

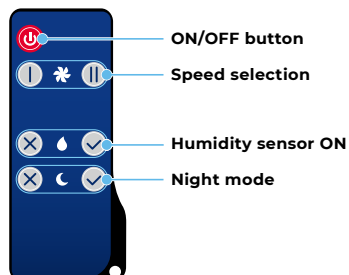

## Mounting example

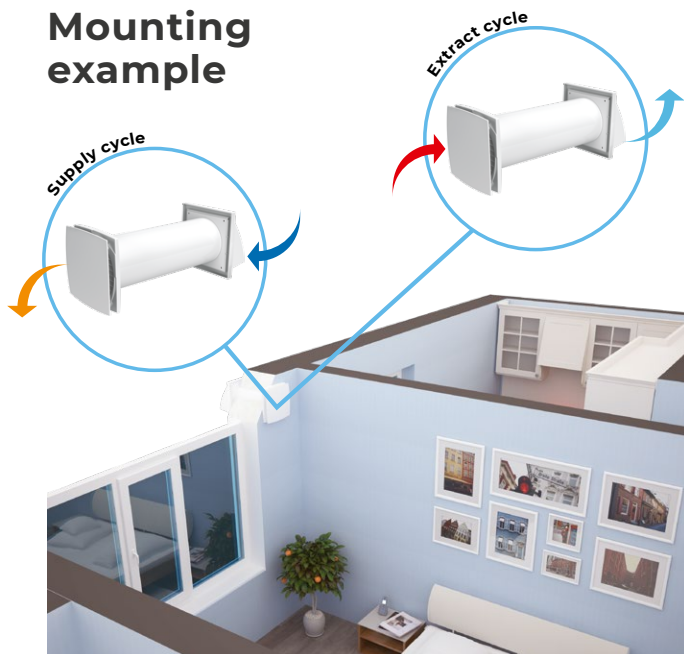

## Overall dimensions [mm]

Model	Ø D	B	B1	L	L1	L2
Solo A35 S4 Pro R V.2	106	150	153	305-380	35	69
Solo A50 S4 Pro R V.2	131	175	186	305-380	35	86
Solo A60 S4 Pro R V.2	156	205	186	305-380	35	86

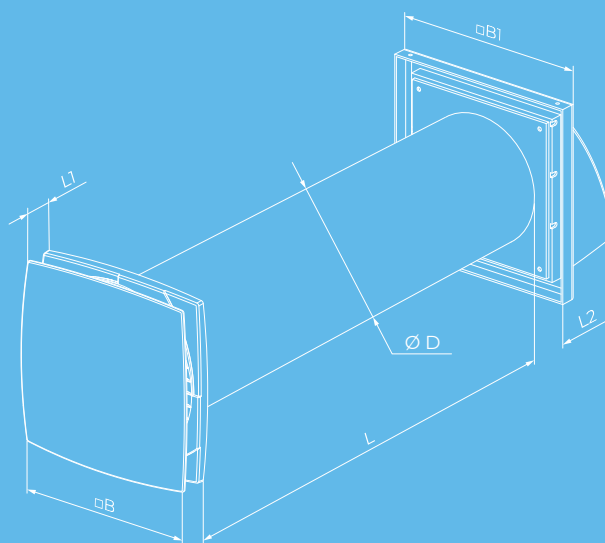

## Technical data

Parameters	Solo A35 S4 Pro R V.2		Solo A50 S4 Pro R V.2		Solo A60 S4 Pro R V.2	
Speed	I	II	I	II	I	II
Voltage [V / 50 (60) Hz]	220-240					
Power [W]	1.50	2.30	0.70	2.30	1.10	3.20
Current [A]	0.046	0.047	0.020	0.034	0.021	0.042
Air flow in ventilation mode [m³/h (l/s)]	30 (8)	46 (13)	25 (7)	50 (14)	35 (10)	60 (17)
SFP [W/l/s]	0.36	0.36	0.20	0.33	0.23	0.38
Sound pressure level at 3 m distance [dBA]	21	26	16	29	27	29
Transported air temperature [°C]	-15...+40					
Recovery efficiency [%]	up to 85					
Regenerator type	Ceramic					
Ingress protection rating	IP24					





# VENTO ECO A50-4 S11 PRO

## HEAT RECOVERY SINGLE-ROOM UNITS



up to  
**50 m<sup>3</sup>/h**



from  
**12 dBA**



up to  
**92 %**



## FEATURES

Arrangement of efficient energy-saving supply and exhaust single-room ventilation in flats, houses, cottages, social and commercial premises.

Air purification with optional F8 filter  
PM2.5 > 99 %.

Protection from outdoor noise.

Humidity balance and regulated air exchange create individually controlled microclimate.

## Designation key

Model	Air duct	Rated air flow [m <sup>3</sup> /h]	Internal grille type	Ventilation hood type	Control
<b>Vento Eco</b>	<b>A:</b> round air duct	50	-4	<b>S11:</b> plastic hood for standard walls <b>S:</b> metal hood for thin walls	<b>Pro:</b> sensor control panel

## Design

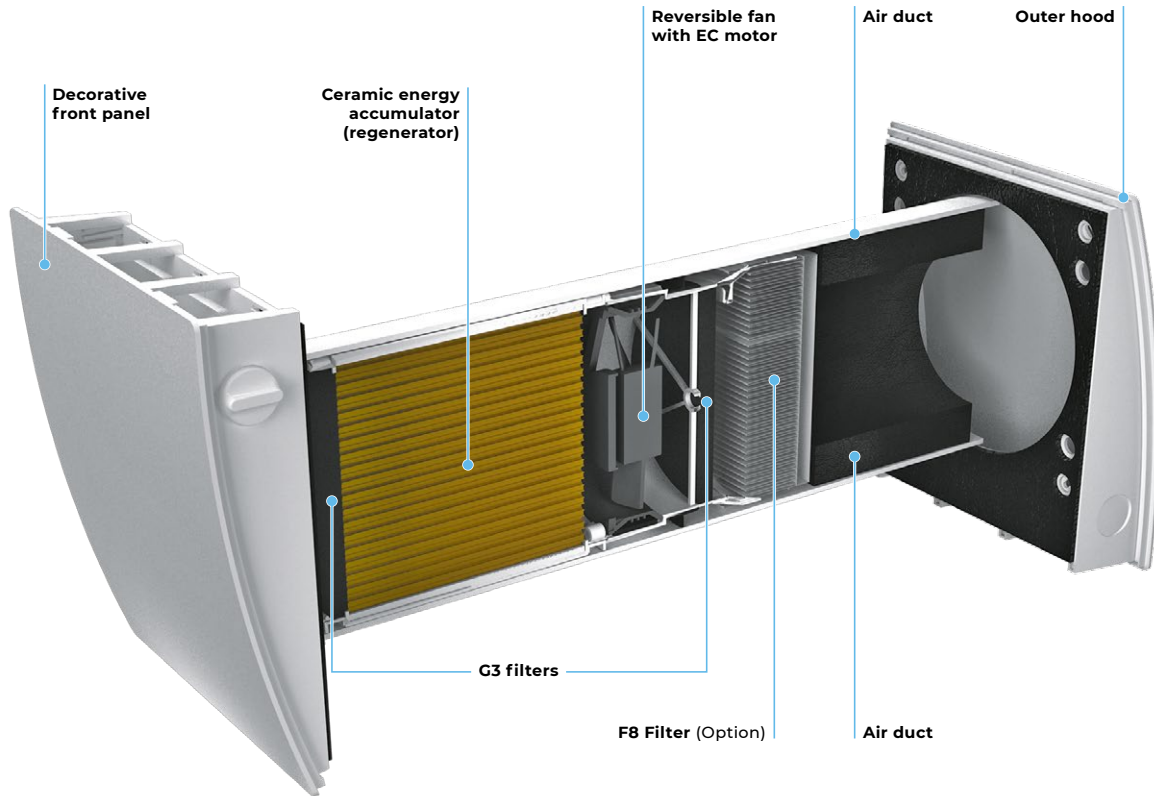

## Heat recovery mode

### UNIT OPERATING LOGIC IN HOT SEASON

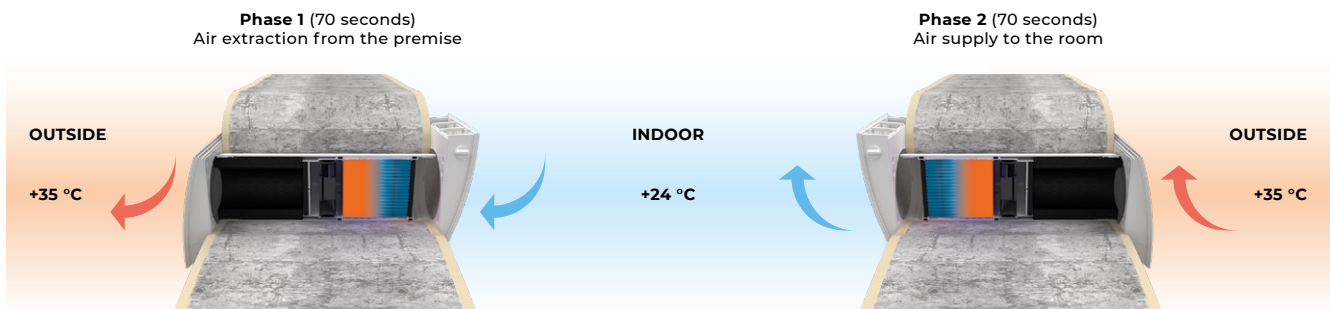

Cooled stale air is extracted from the premise, flows through the ceramic regenerator and transfers its heat energy and moisture to it. As the ceramic regenerator gets cooled down, the unit switches to the supply mode.

Clean hot intake air flows through the regenerator and absorbs accumulated heat and humidity. When the ceramic regenerator is warmed up, the unit switches to the extract air mode.

## Control

Control of the unit operation mode is performed by means of the sensor control panel.

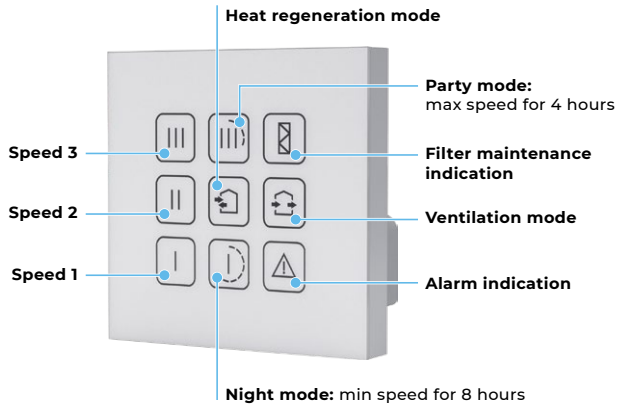

One control panel with sensor buttons can control up to two units.

Low voltage (12 V) power supply between control panel and Vento Eco units.



## Mounting

The unit is designed for through-the-wall installation inside a prepared hole in an outer wall of the building.

One unit is able to ventilate a room up to 25 m<sup>2</sup>. For bigger rooms two or more units must be installed.



## Overall dimensions [mm]

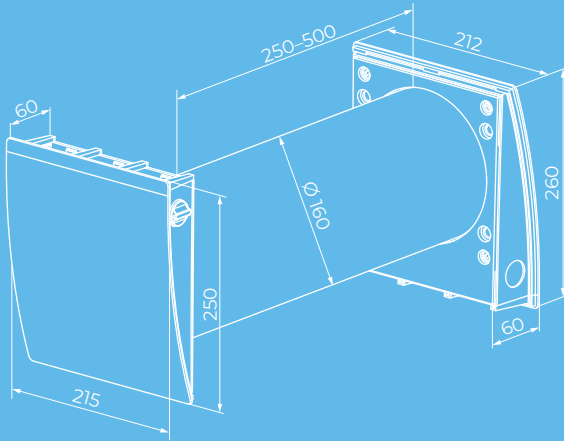

Vento Eco A50-4 S11 Pro

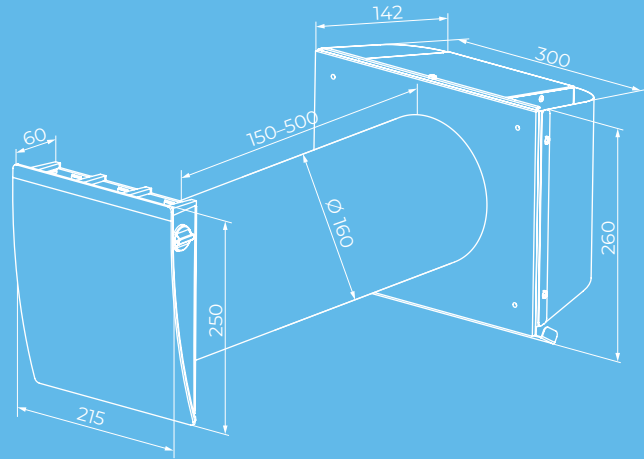
Vento Eco A50-4 S Pro  
(for thin walls)







## Technical data

Parameters	Vento Eco A50-4 S11 Pro / Vento Eco A50-4 S Pro		
Speed	I	II	III
Voltage [V / 50 (60) Hz]	100-240		
Power [W]	1.00	2.10	4.30
Current [A]	0.017	0.025	0.041
RPM [min <sup>-1</sup> ]	915	1555	2330
Air flow in ventilation mode [m <sup>3</sup> /h (l/s)]	15 (4)	30 (8)	50 (14)
Air flow in heat recovery mode [m <sup>3</sup> /h (l/s)]	8 (2)	15 (4)	25 (7)
SFP [W/l/s]	0.48	0.50	0.62
Filter	G3 (Option: F8 PM2.5 > 99 %*)		
Transported air temperature [°C]	-20...+40		
Temperature exchange efficiency (heating) [%]	92	81	74
Temperature exchange efficiency (cooling) [%]	90	85	80
Enthalpy exchange efficiency (heating) [%]	89	77	66
Enthalpy exchange efficiency (cooling) [%]	83	78	63
Sound pressure level at 1 m according to ISO 3741: 2004 [dBA]	21	27	29
Sound pressure level at 3 m according to ISO 3741: 2004 [dBA]	12	18	20
Ingress protection rating	IP24		

\* maximum air flow 40 m<sup>3</sup>/h

## Accessories

		Description
<b>Completion Kit Vento Eco A50-4</b>		Indoor grille and cartridge with heat regenerator, fan and G3 filters
<b>ZL1 Vento 160/150</b>		Cartridge with heat regenerator for cold climate
<b>FP2 Vento G3</b>		G3 filters (2 pcs.)
<b>FP2 Vento F8</b>		G2 + F8 filters (1 pc.). Filtration rate PM2.5 > 99%. Combination of G2 + F8 filters reduces air flow down to 40 m³/h
<b>AH-8 white 160</b>		White painted aluminium outer ventilation hood with frost protection for a cold climate
<b>AH-8 chrome 160</b>		Brushed stainless steel outer ventilation hood with frost protection for a cold climate
<b>AH-10 *colour* 160</b>		Plastic outer ventilation hood. Available in colours:       white black grey terracotta brown vintage
<b>AH-10 chrome 160</b>		Plastic outer ventilation hood with a plate with brushed stainless steel effect finish
<b>AH-11 *colour* 160</b>		Plastic outer ventilation hood. Available in colours:       white black grey terracotta brown vintage
<b>AH-S chrome 160</b>		Outer ventilation hood for thin wall made of brushed stainless steel
<b>AH-S white 160</b>		Outer ventilation hood for thin wall made of stainless steel, painted white

Description		
<b>PP 160/0.5</b>		Outer ventilation hood for mounting from inside
<b>KIT BlauPlast white 160</b>		Kit for angular mounting with white colour grille (for walls with standard thickness)
<b>KIT BlauPlast chrome 160</b>		Kit for angular mounting with stainless steel outer grille (for walls with standard thickness)
<b>R 160-500</b>		500 mm air duct and plastic foam plug
<b>R 160-700</b>		700 mm air duct and plastic foam plug
<b>SE Vento Eco A50 Pro</b>		Sensor control panel



**blaubergventilatoren.de**

Blauberg Ventilatoren GmbH  
Aidenbachstr. 52  
D-81379 Munich

[info@blaubergventilatoren.de](mailto:info@blaubergventilatoren.de)

The manufacturer reserves the right to make any changes due to the need for production, without prior notice.

**7|2023**

