

CEILEO DC

CENTRIFUGAL FANS

Centrifugal exhaust low noise and low watt fans for ceiling mounting



Air flow:
up to 254 m³/h
71 l/s



Power:
from 19 W
SFP:
from 0.37 W/l/s



Noise level:
from 23 dBA



Features



- Intermittent or continuous ventilation of bathrooms, showers, kitchens and other domestic spaces.
- For high-resistant ventilation systems.
- DC motor with low energy demand.
- Wide speed control range.
- Integrated LED-light with low energy demand (**Ceileo DC Light** models).
- The modular design enables easy retrofitting with the optional humidity and motion sensors (except for the basic model) or the grille with a light.
- Low noise level.
- Constant air flow.
- The centrifugal impeller has forward curved blades for high pressure and low noise.
- The motor impeller is made of high-quality durable ABS plastic.
- The fans also features a gravity backdraft damper.
- Ingress protection rating IPX2.
- Compatible with Ø 100 or 150 mm air ducts.

Motor

- The **Ceileo DC** fans feature high-efficient low power direct current motors with overheating protection.
- The constant air flow technology provides required air flow in a wide range of static pressure.

Design

- The casing is made of galvanized steel.
- The clip-on plastic grille ensures easy mounting and cleaning of the fan.
- The modular design enables easy retrofitting with the optional humidity and motion sensors (except for the basic model) or the grille with a light.

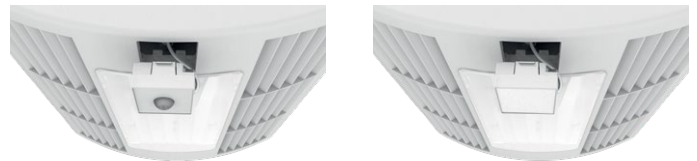

- **Ceileo DC Light** fans are both equipped with an energy efficient LED light.

Power: 10 W
Colour temperature:
3 000 K
Luminous flux:
650 lumens



Power: 60 W

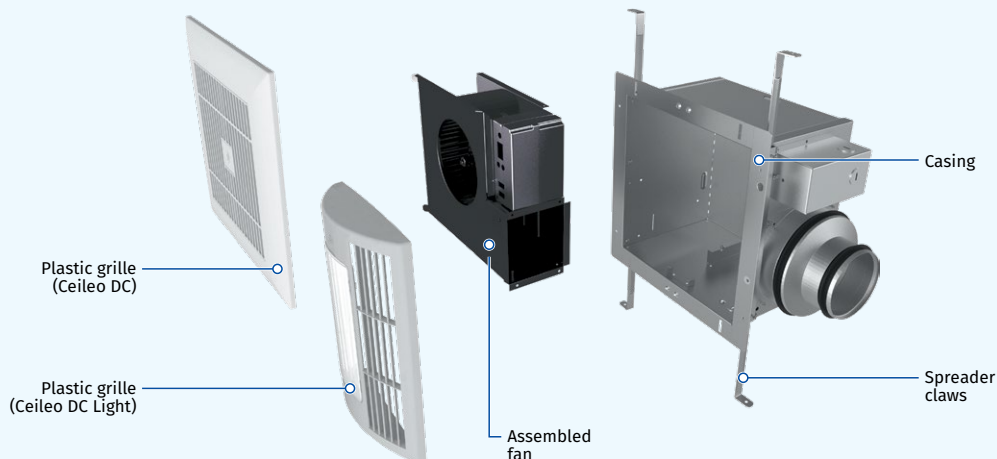

CEILEO DC

CENTRIFUGAL FANS

Options

Ceileo DC fans include an integrated turn-off delay timer. The fan can also be retrofitted with an optional humidity or motion sensor (available on a special order basis).

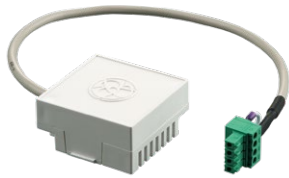

Humidity sensor

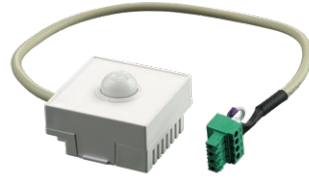

Motion sensor

Control

The built-in control panel of the Ceileo DC fans enables the following settings:

- turn-off delay
- humidity level
- air flow for modes 1 and 2

Name	Adjustment range for operation modes 1 and 2
Ceileo DC 110	Off / 100 / 120 / 135 / 155 / 170 / 190 m³/h
Ceileo DC 150	Off / 100 / 120 / 135 / 155 / 170 / 190 / 205 / 220 / 240 / 250 m³/h

Ceileo DC control panel



MANUAL CONTROL

The fan is controlled by means of the CDP-2/10 speed switch (available as a specially ordered accessory).



AUTOMATIC CONTROL



Timer: The fan is constantly set to the mode 1. The mode 2 is triggered by the light switch closing. Upon the light switch opening the built-in turn-off delay timer keeps the fan running in the mode 2 from 1 to 90 minutes. On elapsing of this period the fan reverts to the mode 1.



Timer and humidity sensor (available as a specially ordered accessory): the fan runs permanently in the mode 1. If the humidity level on the premises exceeds the sensor threshold value set in the 60-90 % range, the fan switches to the mode 2. When the humidity level reverts to the pre-set value, the built-in turn-off delay timer keeps the fan running in the mode 2 from 1 to 90 minutes. On elapsing of this period the fan reverts to the mode 1.



Timer and motion sensor (available as a specially ordered accessory): the fan runs permanently in the mode 1. If the motion sensor detects movement within its range, the fan goes to the mode 2. When the movement is no longer registered, the built-in turn-off delay timer keeps the fan running in the mode 2 from 1 to 90 minutes. On elapsing of this period the fan reverts to the mode 1.

Overall dimensions

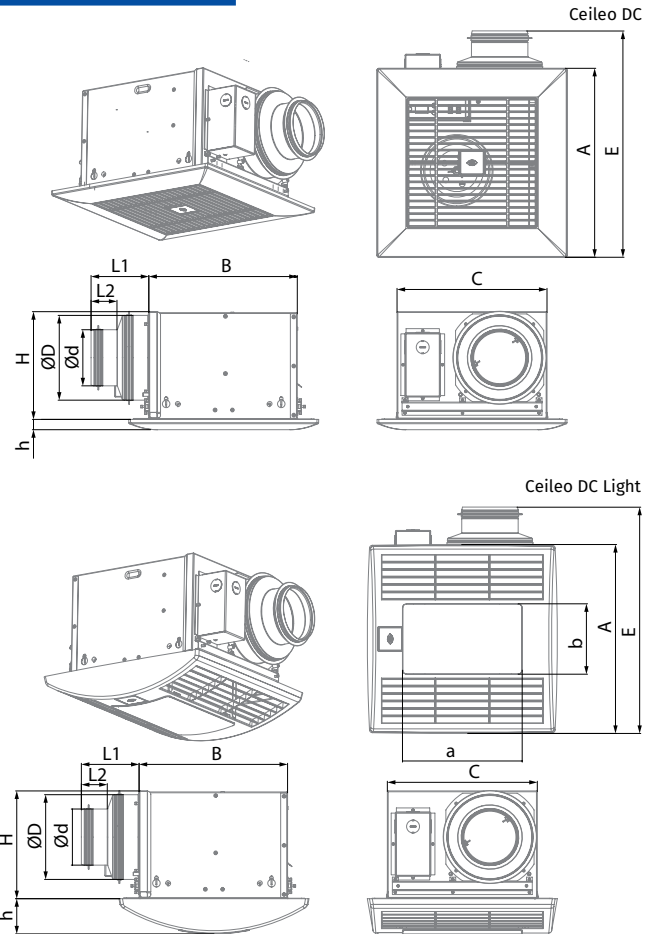

Dimensions [mm]	Ø D	Ø d	L1	L2	A	B	C	E	H	h	a	b
Ceileo DC 110	148	98	100	45	330	258	260	395	188	18	-	-
Ceileo DC 110 Light	148	98	100	45	330	258	260	395	188	62	208	123
Ceileo DC 150	149	-	50	-	330	258	260	395	188	18	-	-
Ceileo DC 150 Light	149	-	50	-	330	258	260	395	188	62	208	123

Mounting

- The fan is integrated into ceiling spaces.
- The fan is attached to the ceiling joists with spreader claws and self-tapping screws.
- The flexible air duct is attached to the fan exhaust spigot with a fixing clamp.



Designation key

Ceileo	DC	110	Light
Series	DC motor	Rated air flow [CFM]	LED-lamp available

CEILEO DC

CENTRIFUGAL FANS

Technical data

Model	Ceileo DC 110 Ceileo DC 110 Light	Ceileo DC 150 Ceileo DC 150 Light
Voltage [V/Hz]	120-240/50(60)	120-240/50(60)
Power [W]	19	26
LED-light power [W]**	2 × 10	2 × 10
RPM [min ⁻¹]	1100	1100
Current @ 230 V (120 V) [A]	0.18 (0.3)	0.24 (0.39)
Air flow [m ³ /h (l/s)]	187 (52)	254 (71)
SFP [W/l/s]	0.37	0.37
Sound pressure level [dBA]*	23-25	23-29
Weight [kg]	5.3 (6.4**)	5.1 (6.2**)
Ingress protection	IPX2	IPX2
SEC class***	B	B

* Sound pressure level measured in free space at a distance of 3 meters from the fan.

** Only for the Light model

*** For fans with humidity or motion sensors



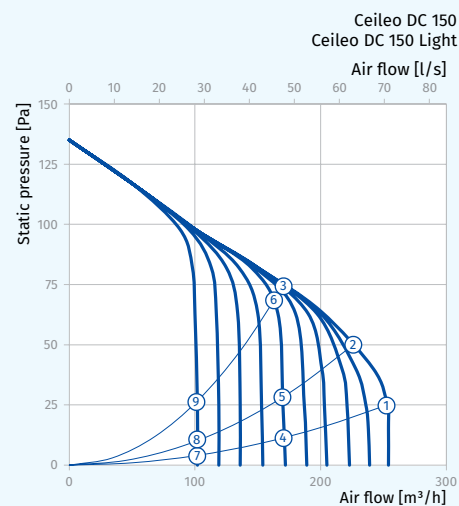
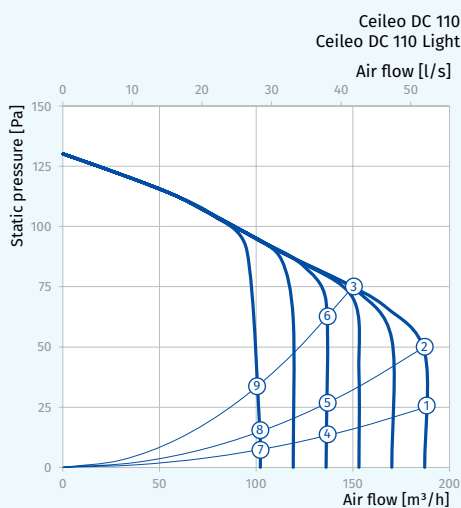









Point	Ceileo DC 110 Ceileo DC 110 Light	Ceileo DC 150 Ceileo DC 150 Light
1	17	24
2	19	22
3	16	19
4	9	13
5	12	15
6	15	17
7	4	5
8	4	5
9	6	6



CEILEO DC

CENTRIFUGAL FANS

Accessories

Accessory name	Description	Ceileo DC 110 Ceileo DC 110 Light	Ceileo DC 150 Ceileo DC 150 Light
CDP-2/10 	Speed switch	•	•
HS Ceileo 	Humidity sensor	•	•
IRS Ceileo 	Motion sensor	•	•
Decor S 102 HK 	Stainless steel ventilation hood Ø 100 mm	•	
Decor S 152 HK 	Stainless steel ventilation hood Ø 150 mm	•	•
Decor 155x155/100H 	Ventilation hood Ø 100 mm	•	
Decor 185x185/150H 	Ventilation hood Ø 150 mm	•	•
BlauFlex PVC/102/3 	Flexible air duct Ø 100 mm, 3 m long	•	
BlauFlex PVC/152/3 	Flexible air duct Ø 150 mm, 3 m long	•	•
K 100 	Quick-detachable stainless steel clamp Ø 90-110 mm	•	
K 150 	Quick-detachable stainless steel clamp Ø 140-160 mm	•	•
CH-PLC-10WG23 	10 W LED-light with colour temperature 3000 K (only for the Light models)	•	•