



DC INVERTER VRF SYSTEM

PRODUCT CATALOGUE

CONTENTS

NEW GENERATION FULL DC INVERTER EVI VRF	3
SMALL CAPACITY FULL DC INVERTER VRF UNIT	18
NEW GENERATION BLHV MINI SMALL CAPACITY DC INVERTER VRF	22
INDOOR UNITS LINE UP	24
CONTROLLERS	38

DESIGNATION KEY

Brand name	Name of the unit	Compressor execution	Compressor type	Rated capacity	The unit	Indoor unit type	Indoor unit fan	Power supply	Refrigerant unit	Generation
BLAUBERG	BLHV	_: DC by default E: EVI	R: rotary S: scroll	050, 080, 100, 120, 140, 160, 180, 200, 224, 260, 280, 335, 400, 450, 500, 560, 615, 670, 730, 800, 850, 900, 22, 28, 36, 45, 56, 71, 80, 90, 112, 150, 250	O: outdoor unit I: indoor unit	C4: 4flow cassette CR: round flow cassette W: wall mounted DL: ducted low pressure DM: ducted medium pressure DH: ducted high pressure FC: floor-celing FA: fresh air unit	AC DC	3 - 380-415V/ 3ph/50Hz 1 - 220-240V/ 1ph/50Hz	R3: R32 R1: R410A	A: 1st generation

BLHVE PRO

VRF SYSTEM



Capacity	8HP 25.2kW	10HP 28kW	12HP 33.5kW	14HP 40kW	16HP 45kW	18HP 50kW	20HP 56kW	22HP 61.5kW	24HP 67kW	26HP 73kW	28HP 78.5kW	30HP 85kW	32HP 90kW
Compressor	DC	DC	DC	DC	DC	DC	DC	DC	DC+DC	DC+DC	DC+DC	DC+DC	DC+DC
Fan motor	DC	DC	DC	DC	DC	DC+DC	DC+DC	DC+DC	DC+DC	DC+DC	DC+DC	DC+DC	DC+DC

EER&COP

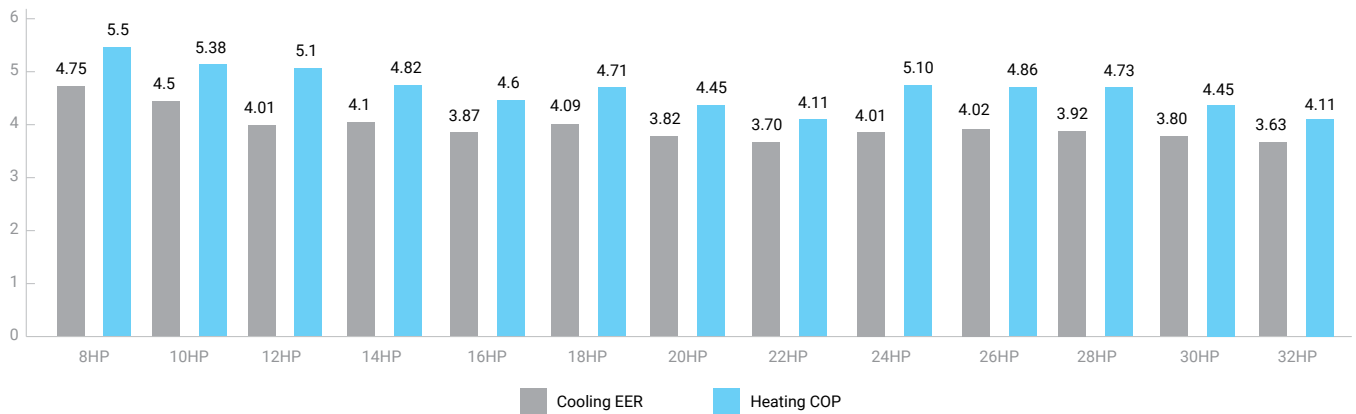

IPLV(C)

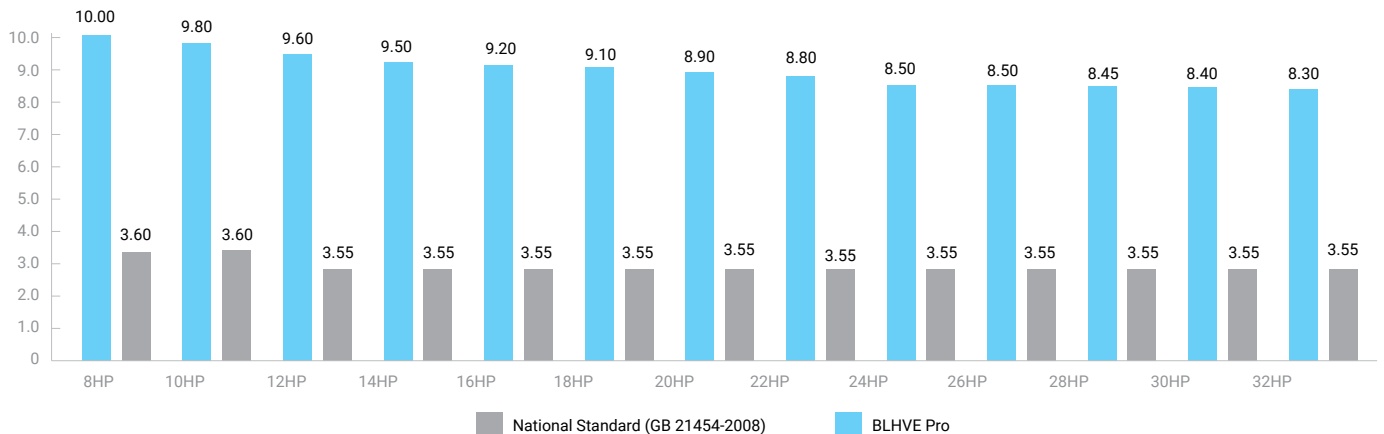

BLHVE PRO

VRF SYSTEM

COMBINATION TABLE

HP	Cooling Cap. [kW]	8HP	10HP	12HP	14HP	16HP	18HP	20HP	22HP	24HP	26HP	28HP	30HP	32HP
8	25.2	•												
10	28		•											
12	33.5			•										
14	40				•									
16	45					•								
18	50						•							
20	56							•						
22	61.5								•					
24	67									•				
26	73										•			
28	78.5											•		
30	85												•	
32	90													•
34	95					•	•							
36	100						••							
38	106.5					•			•					
40	111.5						•		•					
42	117.5							•	•					
44	123								••					
46	128.5								•	•				
48	134									••				
50	140								•			•		
52	145.5									•		•		
54	152									•			•	
56	157									•				•
58	163										•			•
60	168.5											•		•
62	175												•	•
64	180												•	••
66	184.5								•••					
68	190								••	•				
70	195.5								•	••				
72	201.5								••			•		
74	207						•					••		
76	212.5									••		•		
78	218.5								•			••		
80	224									•		••		
82	230										•	••		
84	235.5											•••		
86	242											••	•	
88	247											••		•
90	253										•			••
92	258.5											•		••
94	265												•	••
96	270													•••

*Note: Max. 4 outdoor units can be freely combined to become a larger unit, the maximum capacity of single system is 96HP, when 4 outdoor units are combined, the single unit capacity can not exceed 24HP.

BLHVE PRO

VRF SYSTEM

REFRIGERANT PIPING

The total pipe length	The longest pipe length	Height difference Outdoor unit above	Height difference Outdoor unit below	Height difference between indoor units	Length from first indoor distributor to last indoor unit	Communication wire length
1000 m	200 /240m	<100m	<110m	40m	90 m	can be up to 1000m

FEATURES

LONG DISTANCE REMOTE CONTROL

- o Long distance remote control by phone or tablet.

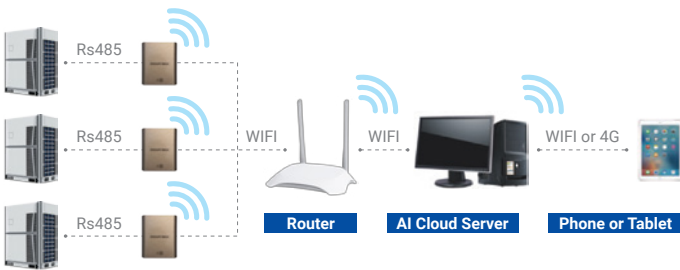

MALFUNCTION FORECASTING

- o Thanks to the AI cloud server, malfunction can be forecasted when system running parameter is abnormal.
- o Technician can be sent to site to check the system before it stops.

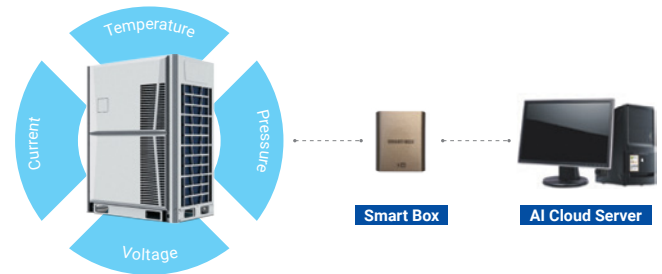

REFRIGERANT COOLING DESIGN

- o We use refrigerant to cool down inverter modular board to keep it in a safe condition even when outdoor temperature is up to 55°C.



WIDE OUTDOOR OPERATION RANGE

- o Due to EVI technology, BLHVE PRO heating performance increased by 35% compare to conventional VRF system.
- o Due to EVI technology, BLHVE PRO still has 85% of rated capacity even in -15°C.

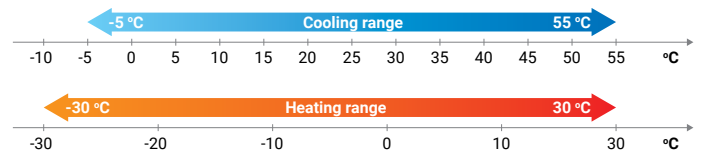

*Based on GBLHVE internal test report

POWER SAVING MODE

- o According to power usage, realize 7-level power limit setting.

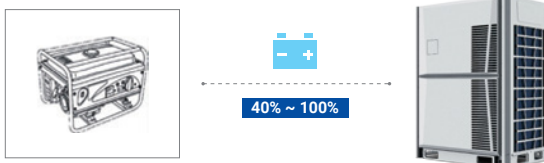

REFRIGERANT STATUS DETECTION

- o Built-in with smart refrigerant auto check function, which can give suggestion about refrigerant status.
- o Different code means different refrigerant status:



- 13** Extremely insufficient
- 12** Insufficient
- 11** Slightly insufficient
- 0** Normal
- 1** Slightly excess
- 2** Overmuch

BLHVE PRO

VRF SYSTEM

MORE INDOOR UNITS

- Max. 100 Indoor units can be connect in ONE system.



ELECTRICAL LOCK FUNCTION (OPTIONAL)

- In case of end user doesn't pay as contract, electrical lock function can be used to stop VRF system, and end user can not start the system without permission.
- System can be unlock with password by authorized technician.



WIRELESS COMMUNICATION (OPTIONAL)

- Wireless communication between indoor units.
- Wireless communication between indoor unit and outdoor unit.



ONLINE DIAGNOSIS

- Technician can do the commissioning & diagnosis by phone or tablet online.

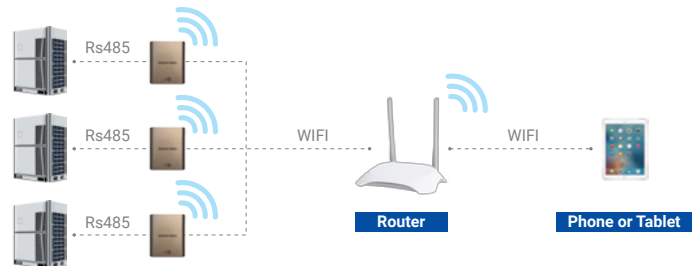

SERVICE WINDOW ON FRONT COVER

- Thanks to the service window, checking outdoor units status and setting is now easy, no need to remove the front cover.

Thanks to the service window, checking outdoor units status and setting is now easy, no need to remove the front cover.

- Error code check
- Function setting
- Commissioning



AUTO CHARGING REFRIGERANT (OPTIONAL)

- BLHVE PRO can customize with auto refrigerant charging function, additional solenoid valve will be added in gas pipe, and outdoor unit will control the valve to charge refrigerant.

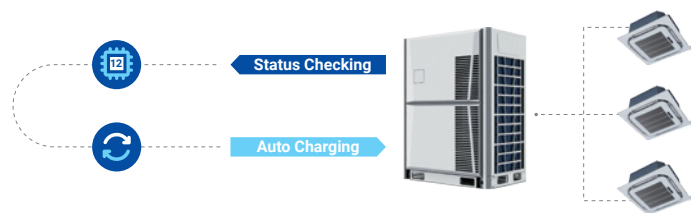

13 BASIC MODULES



MAXIMUM 96HP

- Max. 3 outdoor units can be freely combined to become a larger unit. The maximum capacity of single system is 96HP.

*:when 4 outdoor units are combined, the single unit capacity can not exceed 24HP.



BLHVE PRO

VRF SYSTEM

ADVANTAGES

HIGH EFFICIENCY

LOW CARBON LIFE ADVOCATE

Blauberg always focus on low-carbon energy-saving products development, and spare no effort for technological research and development, to become a practitioner and advocate of low-carbon technology!

CORE TECHNOLOGIES MAKE HIGH EFFICIENCY

Brushless DC Motor

- High efficiency
- Low noise

180° Sine Wave Control

- High precision rotor speed control

Stepless Control

- On-demand output, high efficiency and energy saving

CCT Inner-grooved Tube

- Excellent heat-exchanging efficiency

2-in-1 Refrigerant Flow Path

- Increase the liquid refrigerant volume proportion

Cross Flow Fins

- Reduce wind resistance and improve heat exchange efficiency

DC Inverter Compressors

- High pressure type
- Asymmetric scroll design
- Neodymium permanent
- Magnet rotor

G Type Condenser

- Enlarge the heat exchange area, and the heat exchange effect is better

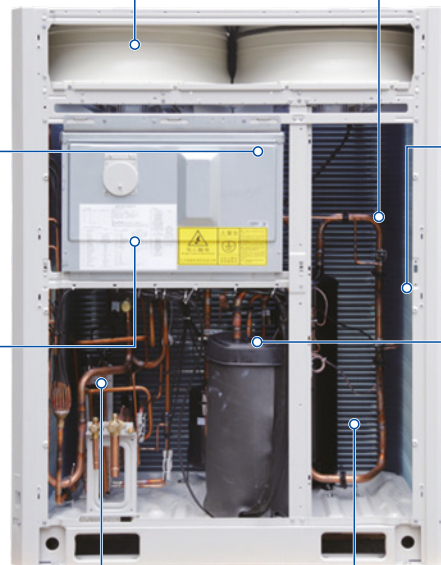

BLHVE PRO

VRF SYSTEM

HIGH EFFICIENCY DC INVERTER COMPRESSOR

- o From Hitachi, a well-known inverter compressor manufacturer.
- o R410a ECO friendly refrigerant.
- o Small torque fluctuation, low vibration and quiet operation.
- o High efficiency due to its patent internal structure design.
- o Internal oil circulation structure.
- o High reliability.
- o Wide rotation speed range.
- o Neodymium permanent magnet rotor, has powerful magnetic force, large torque and high efficiency.
- o Concentrated winding, improving low frequency efficiency.
- o High pressure chamber.
- o Has small suction superheat and high refrigerant volume efficiency.
- o Has large refrigerant discharge buffer volume, low vibration and noise.

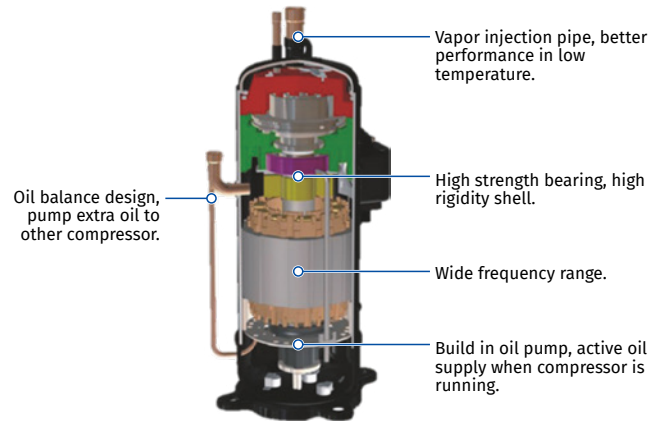

Neodymium permanent magnet rotor

Powerful magnetic force, large force moment and high efficiency

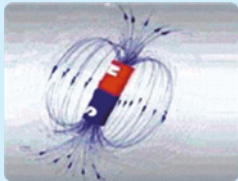

Ferrite magnet

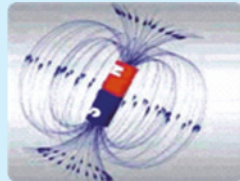

Neodymium permanent magnet

Concentrated winding

Magnetic efficiency is 12% higher than distributed winding



Concentrated winding

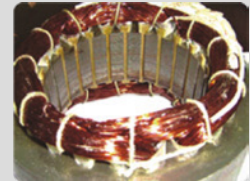

Distributed winding

HIGH EFFICIENCY DC MOTOR

- o High efficiency DC fan motor is from well-known brand.
- o Low noise and high efficiency because of high-density wire winding engineering.
- o Brushless with built-in sensor.



STEPLESS CONTROL

- o DC fan motor can be stepless controlled by outdoor PCB according to system's operating pressure. And it is able to reduce the energy consumption and maintain the system in the best performance.

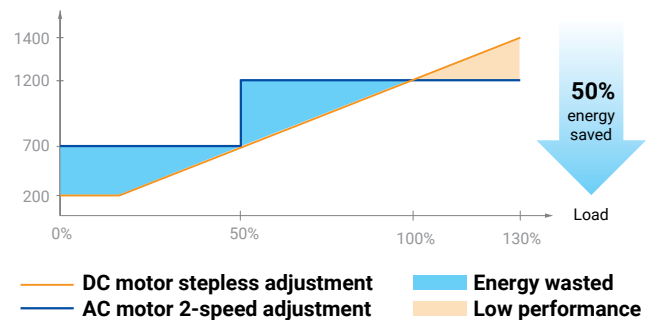

180° SINE WAVEFORM CONTROL

- o The perfect combination of 180° Sine waveform rotor frequency drive control technology and excellent IPM inverters, reduces the reactive loss of motor-driven, increases motor efficiency by 12%.

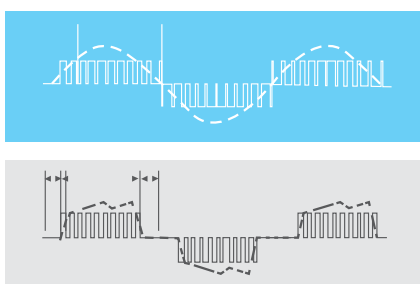

Increase efficiency by 12%

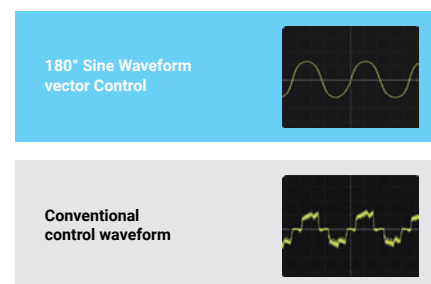

BLHVE PRO

VRF SYSTEM

CCT INNER-GROOVED TUBE

o CCT (Continuous Cooling Transformation) inner-grooved copper tube has high thermometric conductivity. This inner-grooved fins break the refrigerant flow boundary layer to enhance refrigerant disturbance to increase heat-exchanging efficiency.

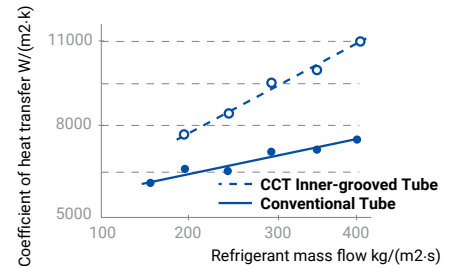
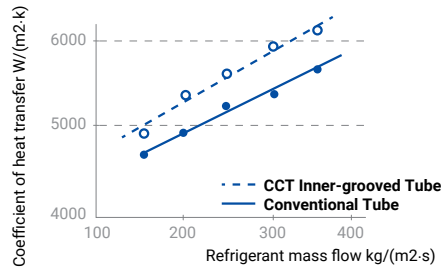
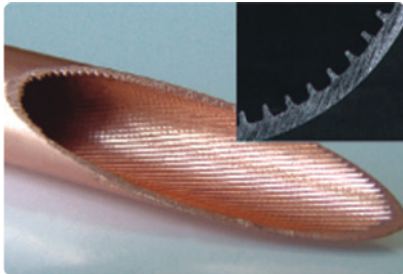

2-IN-1 REFRIGERANT FLOW PATH DESIGN

o CCT (Continuous Cooling Transformation) inner-grooved copper tube has high thermometric conductivity. This inner-grooved fins break the refrigerant flow boundary layer to enhance refrigerant disturbance to increase heat-exchanging efficiency.

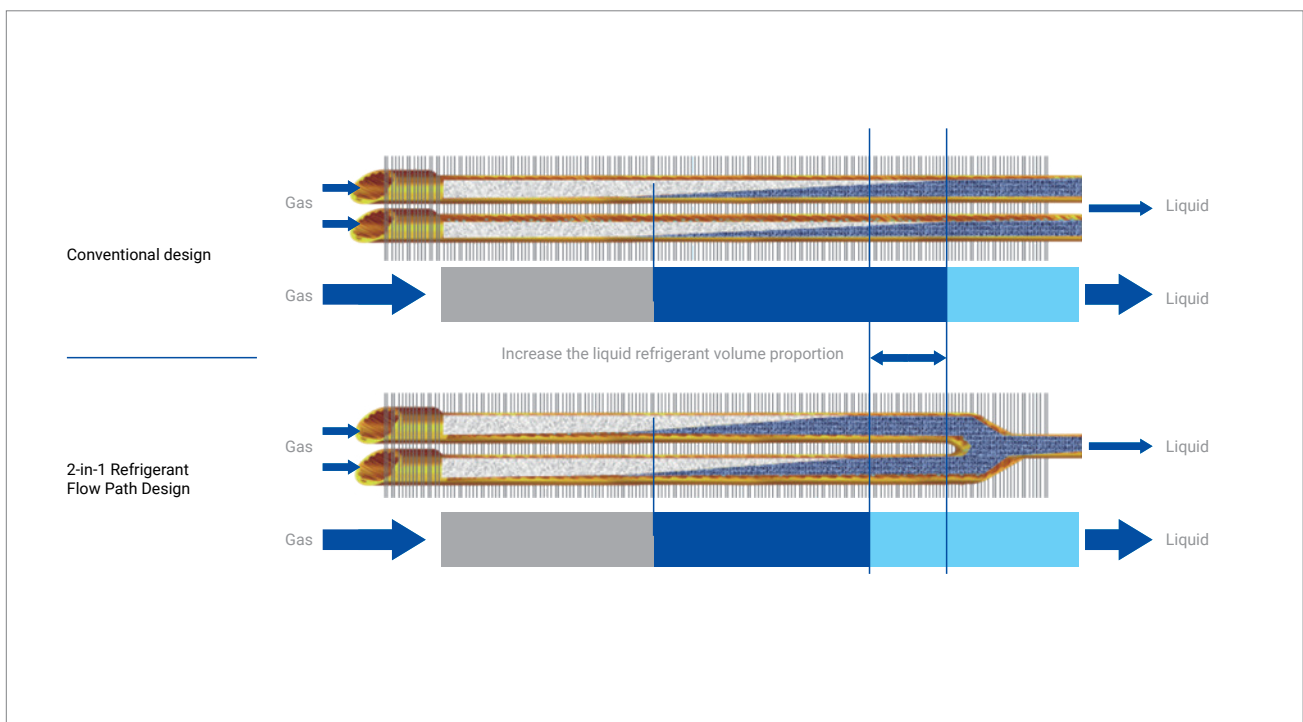
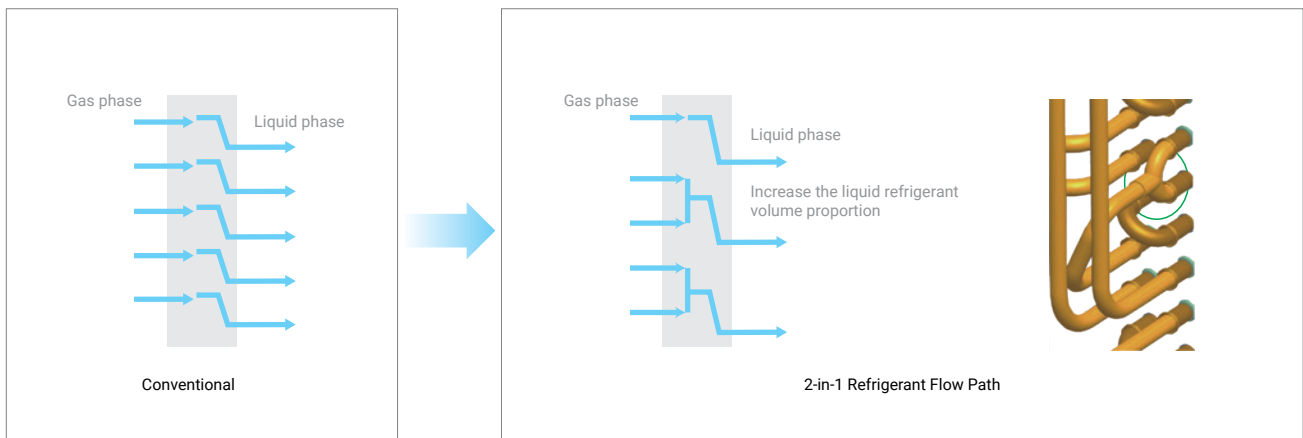

BLHVE PRO

VRF SYSTEM

SUPERCOOLING FLOW PATH DESIGN

- Supercooling flow path design, separates the refrigerant inlet and outlet, increase the supercooling degree, reduce the effect of high temperature inlet gas refrigerant to low temperature outlet liquid refrigerant, therefore, the system efficiency will be greatly increased.

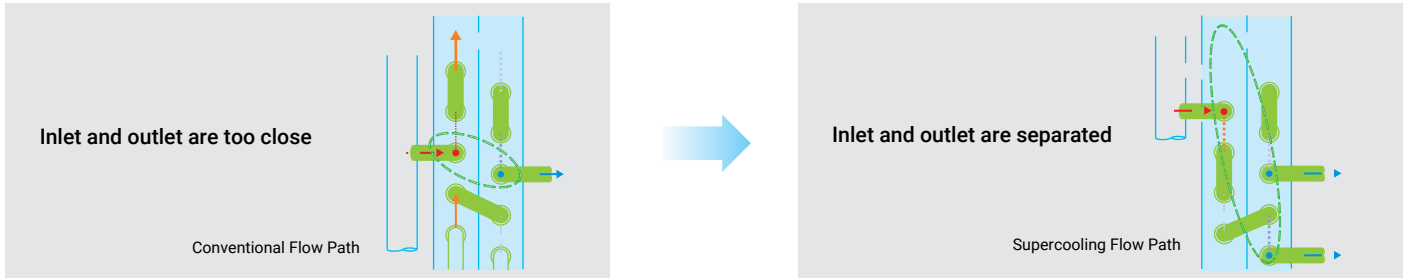

CROSS FLOW FINS

- Have low air resistance and great heat transfer coefficient.
- Frosting improved, frost on the heat-exchanger will be well-distributed, easy for defrosting.

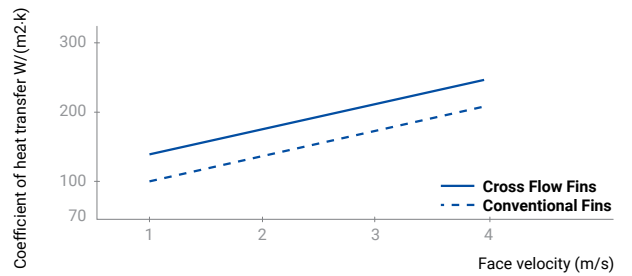
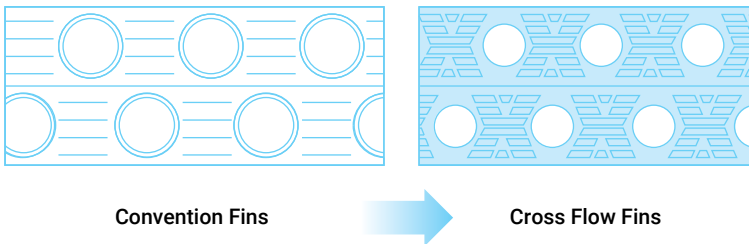

LOW RESISTANCE INTERNAL PIPING

- Thanks to the optimization pipeline design, 5% pressure drop are reduced.
- EER and COP increase, because of evaporating temperature increase and compressor work decrease.

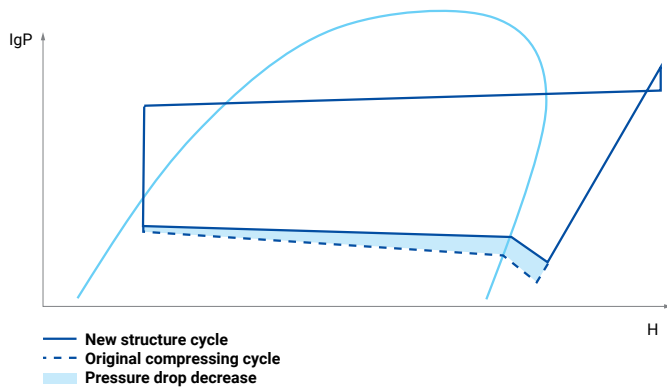

THE PHE ECONOMIZER

- PHE Economizer technology provide an additional sub cooling.
- Improved heat exchanger+PHE economizer+Optimized control logic.
- Heating performance highly increased.



BLHVE PRO

VRF SYSTEM



BENEFITS FOR USERS

LIVABLE ENVIRONMENT CREATOR

Blauberg focuses on starting point of CAC system: create a friendly, comfortable and pleasant living environment as always. DC inverter VRF system's comfort technologies include quick cooling and heating, precise temperature control, low noise, use environmental friendly refrigerant and so on, we strive to create livable environment for users.

OUTSTANDING COMFORT ABILITY

- BLHVE system has excellent cooling&heating performance thanks to the high efficiency DC fan motor, DC compressor and optimized refrigerant flow control logic.
- Precisely room temperature control by adopting 2000 pulse EXV. Indoor temperature fluctuations can be maintained within 0.5 °C, providing outstanding comfort ability.

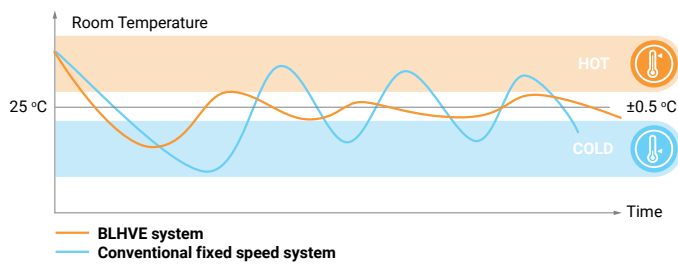

WIDE OPERATION RANGE

- BLHVE PRO has a wide ambient temperature operation range, cooling at -5 – 55 °C, and heating at -30 – 30 °C.



7 IMPROVEMENTS TO REDUCE NOISE

- Maximum 10 dB(A) of operating sound decrease.

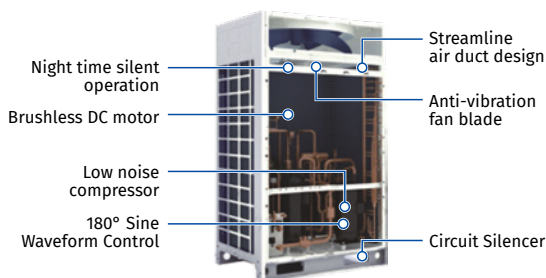

SNOW-PROOF FUNCTION

- In the cold weather, outdoor fan will start to run for a while at intervals to prevent the snow to accumulate on fan blade, because accumulated snow will freeze and block fan blade rotating, even worse it will damage the motor.



BLHVE PRO VRF SYSTEM

SILENT MODE, NIGHT TIME NOISE CONTROL

- Compressor and fan motor rotating speed can be reduced to lower the noise at night.
- Maximum 10 dB(A) decrease.

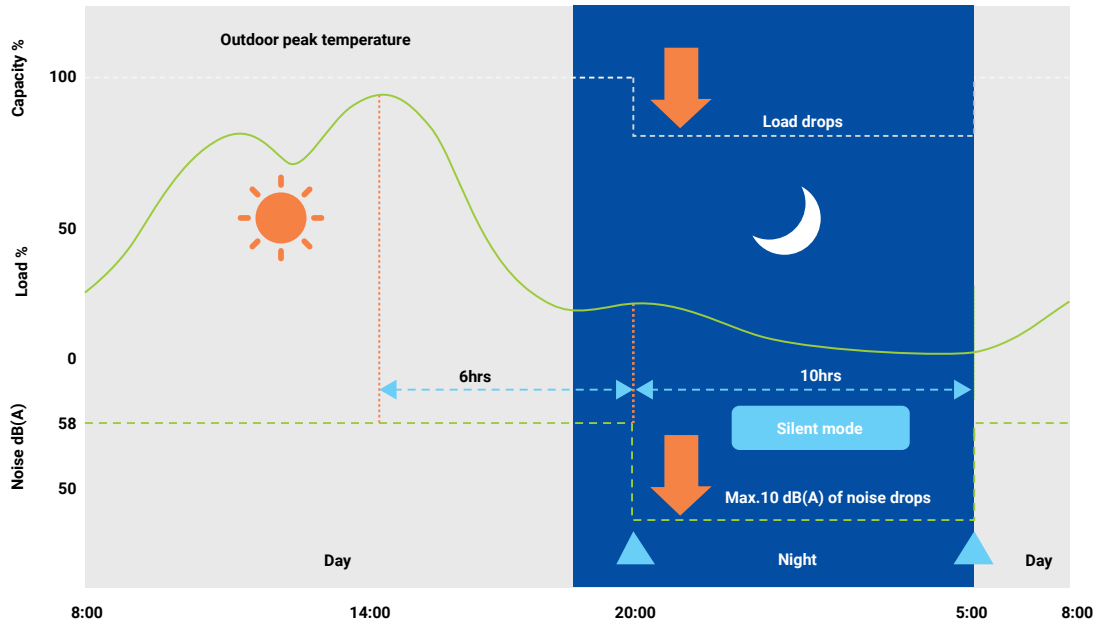

LOW NOISE FAN BLADE

- Fan blade with 7 noise reduction design, effectively reduce the noise while operation.
 - Front edge curve design
 - Thickened front edge design
 - Outer edge turn over design
 - Bionic fan blade design
 - Concave fan blade design
 - Anti-resonance design
 - Tail edge cut design

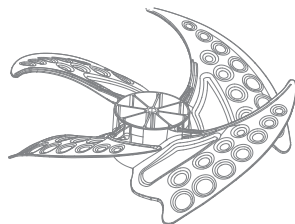

ENVIRONMENT FRIENDLY

- Refrigerant R410A(HFC), low carbon footprint, no harm to Ozone.

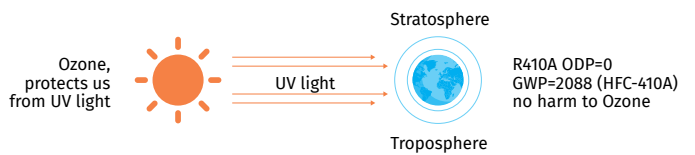

3-STAGE BACKUP FUNCTION

Module backup function.
When some modules are failure, the others can keep running by simply settings.

Compressor backup function
When one compressor is failure, the other one can keep running by simply settings.

Fan motor backup function.
When one fan motor is failure, the other one can keep running by simply settings.

BLHVE PRO

VRF SYSTEM

ALL OUTDOOR UNITS CYCLE OPERATION

- o In one combination system, any outdoor unit can run as master unit.
- o Cycle operation equalizes the running time of the outdoor units, greatly extending the lifespan of outdoor units in one system.

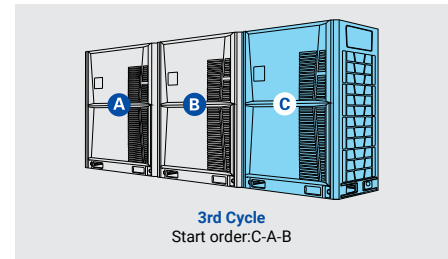
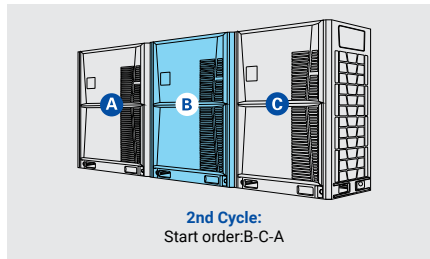
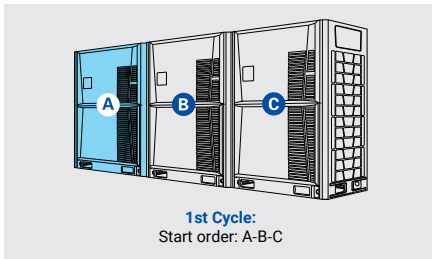

INTELLIGENT DEFROSTING PROGRAM. 5 SPECIAL DEFROSTING MECHANISMS

- o The dedicated temperature sensor monitors the temperature of the condenser coil of the outdoor unit in real time, intelligently selects the defrost mechanism and judges the timing of defrost, effectively prolongs the normal heating time, improves comfort, and achieves energy-saving effects.
 - Normal temperature and low humidity defrosting mechanism.
 - Normal temperature and high humidity defrosting mechanism.
 - Low temperature and low humidity defrosting mechanism.
 - Low temperature and high humidity defrosting mechanism.
 - Ultra-low temperature environment defrosting mechanism.

Defrost Curve

- o Program starts only when unit needs to. Whereas conventional unit's defrosting timing & duration is fixed, causing fluctuations in temperature and personal comfort. Conventional unit's defrosting timing & duration is fixed.
- o Intelligent defrosting program starts according to heat exchanging efficiency & capacity change due to the frost. Less temperature fluctuations, people feel more comfortable.

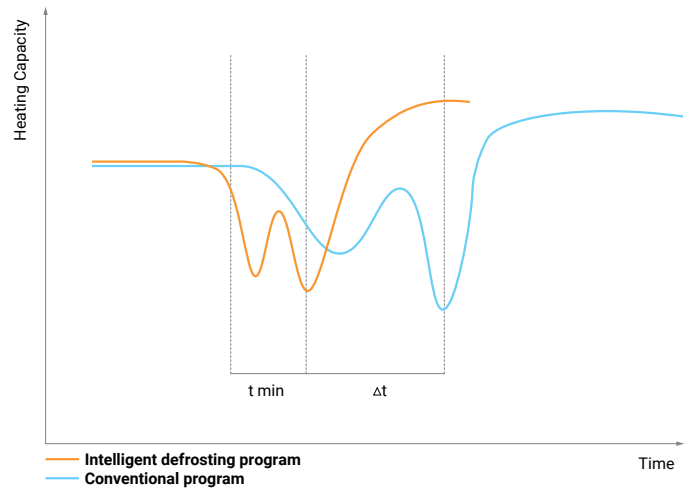

REMOTE ON/OFF CONTROL FUNCTION

- o Indoor units standard build in with ON/OFF control port.
- o It can be used for hotel card control and also can be used for long distance remote ON/OFF control. And no need additional hotel VRF indoor unit control module.
- o When contactor is open (card pulled out), indoor unit will be off can not be controlled, current running parameters will be saved in indoor PCB.
- o When contactor is close (card insert), indoor unit will recover previous running state.

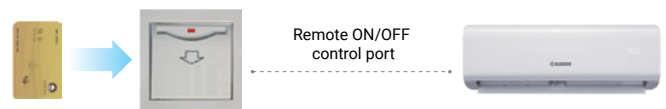

IDU AND ODU POSITIONING FUNCTION

- o Turn on the positioning function through the controller, and all the IDU and ODU of the same system will beep through the built-in buzzer. This is convenient for quick positioning during system commissioning, troubleshooting and after sales maintenance.



BLHVE PRO

VRF SYSTEM



BENEFITS FOR INSTALLERS

OPTIMIZATION FOR DESIGNER AND INSTALLER

BLHVE DC inverter VRF system is designed with flexible modular combination concept. We keep optimizing the module size, reduce equipment in the occupied area to meet the demand of designers and installers. Some unique technologies are used to reduce the workload of our installers, making installation much simpler and easier.

ADJUSTABLE OUTDOOR FAN STATIC PRESSURE

- Thanks to DC fan motor, the external static pressure of outdoor fan is adjustable.
- Outdoor units can be installed in the service floor or facility room.
- Maximum ESP 80 Pa.



TOUCH SCREEN WIRED CONTROLLER

- Air filter cleaning reminding function.
- Touch screen with black background and blue light
- Ultra thin body and stylish design meet high-end environments.
- On/off, temperature setting, fan speed setting, mode setting, timer and check function.



ADDRESSING METHODS

- 2 addressing methods:
 - Automatically addressing: system will distribute address to indoor unit automatically.
 - Manually setting by wired controller or wireless remote controller.
- Addressing method can be selected easily by adjusting the switch on outdoor PCB.



AUTOMATIC ADDRESSING

- Automatic addressing will reduce artificial faults by 35% and 5% manual works.
 - 54% system failure were caused by communication faults.
 - 65% communication faults were caused by address problems.
 - Most of the address problems were: address setting forgotten wrong settings, address repeat.

NEW WIRED CONTROLLER

- Bidirectional communication. Indoor unit's operating parameters (error code, temperature, address) can be inquired and displayed on the controller by adjusting the switch on outdoor PCB.
- Compact design.
- Timer function.
- User can check the error code and inquiry unit status very easy, safe and convenient.

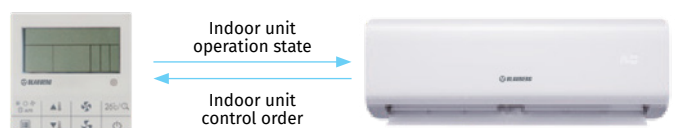

BLHVE PRO

VRF SYSTEM

DIGITAL DISPLAY ON THE PCB

- o Digital display on the PCB, it can show system's operation status and error codes.
- o Record error code list at main PCB chip, easy for service people to check.



SERVICE WINDOW

- o Thanks to the service window, checking outdoor unit's status and setting is now easy, no need to remove the electric control box cover.

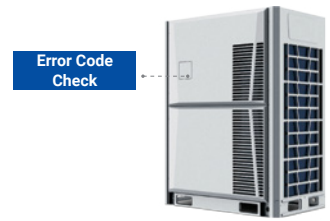

MODE RESTRICTION

- o 6 kinds of mode restriction.
 - Auto priority(Default Setting).
 - Cooling(or heating)priority mode.
 - Cooling only(or heating only)mode.
 - VIP unit priority+AUTO priority mode.
- o Mode restriction function can be selected on the outdoor PCB.

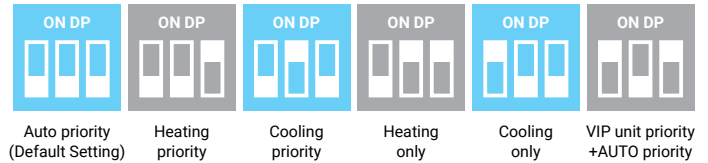

5-STAGE OIL CONTROL

1st stage Compressor internal oil separation Oil separator	2nd stage Oil return from the oil even pipe Oil level control	3rd stage Oil return from the system oil separator Oil separator	4th stage Oil balance between compressors Oil balance pipe	5th stage Oil return by system oil return program Intelligent oil return program
---	--	---	---	---

HUMANIZED INTERNAL STRUCTURE

- o All key components are designed to close to outside, it is convenient for repair and replacement.
- o Thanks to the new balance technology, gas balance pipe does no longer exist, brazing points and leaking risk are decreased.



3-PHASE POWER PROTECTOR(OPTIONAL)

- o Protect the outdoor unit from instable voltage.



EASY INSTALLATION

- o Easy for the outdoor unit to transport to roof floor by elevator due to its compact size.

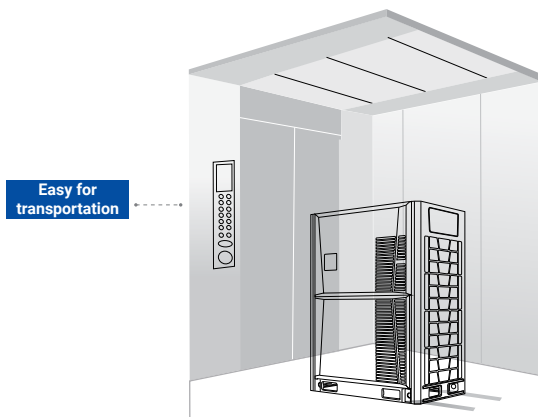

360° PIPE CONNECTION

- o The outlet pipe of the outdoor unit can be extended to all directions through the bottom space;
- o No outlet pipe on the front can improve the aesthetics of installation.



BLHVE PRO

VRF SYSTEM

TECHNICAL DATA

Model Name			BLHVE-S252-O/3R1A	BLHVE-S280-O/3R1A	BLHVE-S335-O/3R1A	BLHVE-S400-O/3R1A	BLHVE-S450-O/3R1A	BLHVE-S500-O/3R1A
Power Supply			380~415V/3N/50&60Hz	380~415V/3N/50&60Hz	380~415V/3N/50&60Hz	380~415V/3N/50&60Hz	380~415V/3N/50&60Hz	380~415V/3N/50&60Hz
Cooling	Capacity	HP	8HP	10HP	12HP	14HP	16HP	18HP
		kW	25.2	28.0	33.5	40.0	45.0	50.0
		Btu/h	86000	95500	114000	136500	153500	170600
		RT	7.2	8.0	9.5	11.4	12.8	14.2
	Rated current	A	9.04	11.30	14.51	18.10	21.60	23.29
	Power input	kW	5.31	6.22	8.35	9.76	11.63	12.22
EER	W/W	4.75	4.50	4.01	4.10	3.87	4.09	
Heating	Capacity	kW	27.4	31.5	37.5	45.0	50.0	56.0
		Btu/h	93500	107500	128000	153500	170600	191000
		RT	7.8	9.0	10.7	12.8	14.2	16.0
	Rated current	A	8.93	11.25	14.34	18.00	20.25	22.61
	Power input	kW	4.98	5.86	7.35	9.34	10.87	11.89
	COP	W/W	5.50	5.38	5.10	4.82	4.60	4.71
Max. input consumption		kW	13.4	14.3	14.8	18.3	18.8	22.0
Max. Current		A	23.1	24.7	25.5	30.8	31.7	37.4
Capacity adjustment range			50%~130%					
Compressor	Quantity		1					
	Type		Scroll Compressor					
	Brand		HITACHI					
Refrigerant	Type		R410a					
	Volume	Kg	9	9	11	14	14	15
	Throttle type		EXV					
Dimension (WxHxD)	Net	mm	990x1740x840	990x1740x840	990x1740x840	1340x1740x840	1340x1740x840	1340x1740x840
	Packing	mm	1060x1900x910	1060x1900x910	1060x1900x910	1410x1900x910	1410x1900x910	1410x1900x910
Weight	Net	Kg	228	228	230	275	275	285
	Gross	Kg	240	240	242	293	293	303
Outdoor sound level	dB(A)		58	58	60	60	61	62
Max. operating range	Mpa		4.5	4.5	4.5	4.5	4.5	4.5
Pipe size	Liquid pipe	mm	Ø 12.7	Ø 12.7	Ø 12.7	Ø 15.88	Ø 15.88	Ø 15.88
	Gas pipe	mm	Ø 22.2	Ø 22.2	Ø 22.2	Ø 28.6	Ø 28.6	Ø 28.6
Max. pipe length	Total pipe length	m	1000					
	ODU to farthest IDU (Actual length)	m	200					
	ODU to farthest IDU (Equivalent length)	m	240					
	1st IDU distributor to farthest IDU	m	40/90					
Max. vertical length	Between ODU & IDU (ODU above IDU)	m	100					
	Between ODU & IDU (ODU below IDU)	m	110					
	Between IDUs	m	40					
	Between ODUs	m	0					
Cooling	Outdoor side	°C	-5~55					
	Indoor side	°C	16~32					
Heating	Outdoor side	°C	-30~30					
	Indoor side	°C	16~32					

1 Cooling operating temperature range is from -5 to 55 (It can be customized down to -10). Heating operating temperature range from -30 to 30.

2 The cooling conditions: indoor side 27 (80.6) DB, 19 (60)WB outdoor side 35 (95) DB.

3 The heating conditions: indoor side 20 (68) DB, 15 (44.6)WB outdoor side 7 (42.8) DB.

4 Sound level: measured at a point 1 m in front of the unit at a height of 1.5 m. During actual operation, these values are normally somewhat higher as a result of ambient conditions.

5 The above data may be changed without notice for future improvement on quality and performance.

BLHVE PRO

VRF SYSTEM

Model Name			BLHVE-S560-O/3R1A	BLHVE-S615-O/3R1A	BLHVE-S670-O/3R1A	BLHVE-S730-O/3R1A	BLHVE-S785-O/3R1A	BLHVE-S850-O/3R1A	BLHVE-S900-O/3R1A
Power Supply			380~415V/3N/50&60Hz	380~415V/3N/50&60Hz	380~415V/3N/50&60Hz	380~415V/3N/50&60Hz	380~415V/3N/50&60Hz	380~415V/3N/50&60Hz	380~415V/3N/50&60Hz
Cooling	Capacity	HP	20HP	22HP	24HP	26HP	28HP	30H	32HP
		kW	56.0	61.5	67.0	73.0	78.5	85.0	90.0
		Btu/h	191000	209800	228600	249100	267800	290000	307100
		RT	16.0	17.5	19.1	20.8	22.3	24.2	25.6
	Rated current	A	26.10	29.06	29.09	32.59	36.13	40.36	44.73
	Power input	kW	14.66	16.62	16.71	18.18	20.03	22.37	24.79
	EER	W/W	3.82	3.70	4.01	4.02	3.92	3.80	3.63
Heating	Capacity	kW	63.0	69.0	75.0	81.5	87.5	95.0	100.0
		Btu/h	214900	235400	255900	278100	298600	324100	341200
		RT	18.0	19.7	21.3	23.2	24.86	27.0	28.4
	Rated current	A	25.70	28.40	28.65	30.28	33.38	38.52	43.9
	Power input	kW	14.16	16.80	14.72	16.78	18.50	21.35	24.33
COP	W/W	4.45	4.11	5.10	4.86	4.73	4.45	4.11	
Max. input consumption		kW	24.4	25.0	26.2	30.7	30.7	35.8	37.7
Max. Current		A	41.1	42.1	43.2	50.8	51.8	60.4	63.6
Capacity adjustment range			50%~130%						
Compressor	Quantity		1			2			
	Type		Scroll Compressor						
	Brand		HITACHI						
Refrigerant	Type		R410a						
	Volume	Kg	16	16	16	20	20	23	23
	Throttle type		EXV						
Dimension (WxHxD)	Net	mm	1340x1740x840	1340x1740x840	1990x1740x840	1990x1740x840	1990x1740x840	1990x1740x840	1990x1740x840
	Packing	mm	1410x1900x910	1410x1900x910	2060x1900x910	2060x1900x910	2060x1900x910	2060x1900x910	2060x1900x910
Weight	Net	Kg	290	297	388	433	433	480	480
	Gross	Kg	308	315	406	452	452	498	498
Outdoor sound level		dB(A)	63	63	62	63	63	64	64
Max. operating range		Mpa	4.5	4.5	4.5	4.5	4.5	4.5	4.5
Pipe size	Liquid pipe	mm	Ø 15.88	Ø 15.88	Ø 15.88	Ø 15.88	Ø 15.88	Ø 15.88	Ø 15.88
	Gas pipe	mm	Ø 28.6	Ø 28.6	Ø 28.6	Ø 35.0	Ø 35.0	Ø 35.0	Ø 35.0
Max. pipe length	Total pipe length	m	1000						
	ODU to farthest IDU (Acual length)	m	200						
	ODU to farthest IDU (Equivalent length)	m	240						
	1st IDU distributor to farthest IDU	m	40/90						
Max. vertical length	Between ODU & IDU (ODU above IDU)	m	100						
	Between ODU & IDU (ODU below IDU)	m	110						
	Between IDUs	m	40						
	Between ODUs	m	0						
Cooling	Outdoor side	°C	-5~55						
	Indoor side	°C	16~32						
Heating	Outdoor side	°C	-30~30						
	Indoor side	°C	16~32						

BLHV MINI

VRF SYSTEM



12.5/14/16/18kW



20/22.4kW



26/28/33.5kW

Capacity	12.5kW	14kW	16kW	18kW	20kW	22.4kW	26kW	28kW	33.5kW
Compressor	DC	DC	DC	DC	DC	DC	DC	DC	DC
Fan motor	DC+DC	DC+DC	DC+DC	DC+DC	DC+DC	DC+DC	DC+DC	DC+DC	DC+DC

EER&COP

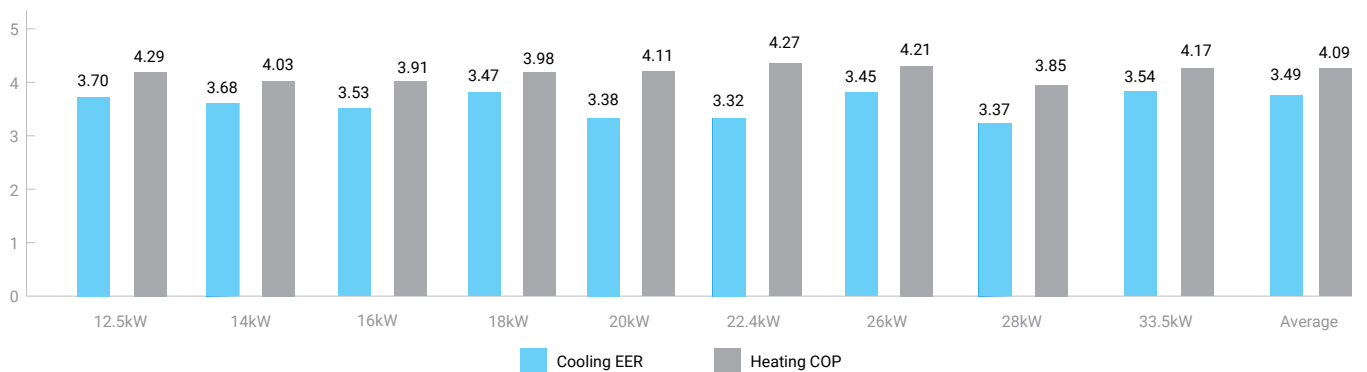

REFRIGERANT PIPING

The total pipe length	The longest pipe length	Equivalent length from first indoor distributor to last indoor unit	Height difference between indoor and outdoor unit:	Height difference between indoor units
100m (12.5-22.4kW) 120m(26-33.5kW)	Actual length 60m Equivalent length 70m	20m	Outdoor unit above≤30m Outdoor unit below≤20m	8m

*Please refer to the installation manual for detailed length description.

FEATURES

HIGH EFFICIENCY DC INVERTER COMPRESSOR

- Twin-rotary DC inverter compressor
 - Use high efficiency and reliability compressor.
 - Has very good efficiency in part load condition.
- High Efficiency, Low Noise
 - Optimized the efficiency and noise during operation with the latest technology.
- Environmental Protection
 - Developed the compressor with alternative refrigerant which can protect environment.
- Low Vibration
 - Reduced the vibration during compressor start and operation by using 2CYL Structure, simplified the match of air-conditioning.

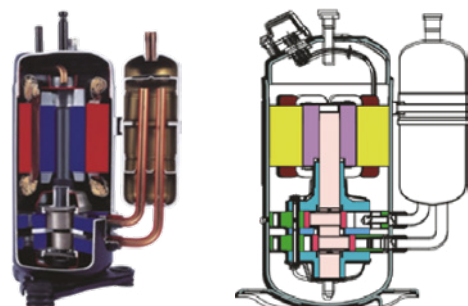

BLHV MINI

VRF SYSTEM

HIGH EFFICIENCY DC MOTOR

- o High efficiency DC fan motor.
- o Low noise and high efficiency because of high-density.
- o wire winding engineering.
- o Brushless with built-in sensor.



WIDE OUTDOOR OPERATION RANGE

- o Max. cooling operating temperature is designed up to 50°C. Heating operating temperature is down to -20°C. In the cold winter, system can heat the room continuously.
- o Outdoor unit running at temperature above 50°C need customized in factory, please consult to sales engineer.

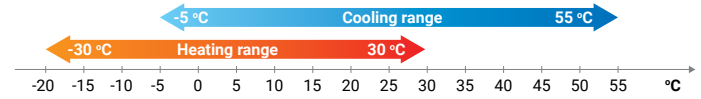

FAST COOLING AND HEATING

- o Every rooms meet set point most quickly and comfortably by optimized refrigerant control.



180° SINE WAVE CONTROL

- o The perfect combination of 180° Sine wave rotor frequency drive control technology and excellent IPM inverters, reduces the reactive loss of motor-driven, increases motor efficiency by 12%.



INTELLIGENT DEFROSTING PROGRAM

- o Program starts only when unit needs to. Whereas conventional unit's defrosting timing & duration is fixed, causing fluctuations in temperature and personal comfort.

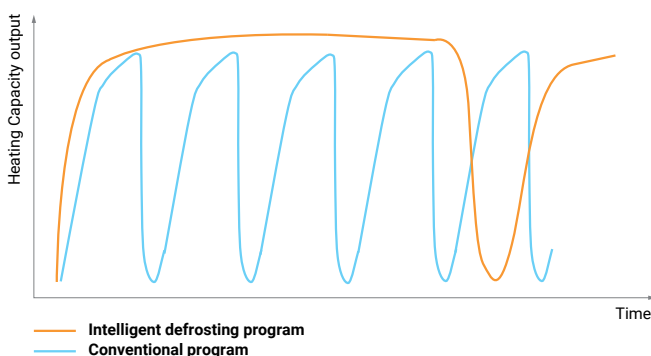

Defrost curve

- o Conventional unit's defrosting timing & duration is fixed.
- o Intelligent defrosting program starts according to heat exchanging efficiency & capacity change due to the frost. Less temperature fluctuations, people feel more comfortable.

BLHV MINI

VRF SYSTEM

SILENT TECHNOLOGY



- Brushless DC motor**
 - Adopting permanent magnet rotor, low vibration and low noise.
- Forwardcurve fan blade**
 - Unique design to increase air flow, reducing the return air resistance, reducing vibration.
- Pipeline silencer**
 - To reduce the refrigerant flow noise.
- Optimized design by CFD**
 - To reduce refrigerant flow resistance and vibration.

FAN REVERSAL PROTECTION

o In standby, if the outdoor fan motor is rotating in opposite direction at a high speed by the wind or other natural factors, the unit can't start so as to keep the fan motor from broken down, it will start when the fan motor speed slow down.

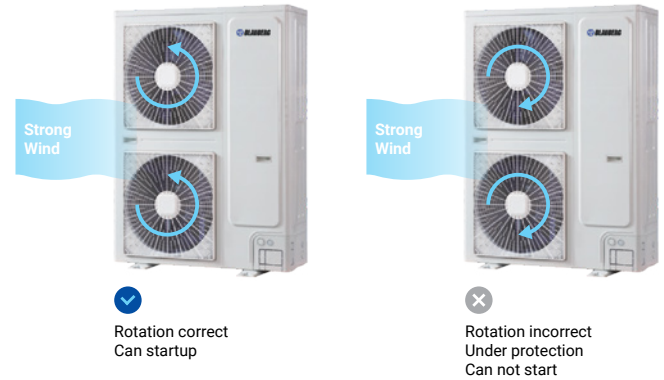

Strong Wind



✓
Rotation correct
Can startup

Strong Wind



✗
Rotation incorrect
Under protection
Can not start

SPACE SAVING INSTALLATION

- o Multiple indoor units can be connected to 1 outdoor unit, and long piping connection is also possible.
- o Compare to one-drive-one type, the outdoor unit can be installed in various places to realize the space-saving installation.



✓



✗

HIGH EFFICIENCY

- o Refrigerant cooling technology for PCB
 - The radiation fin is made of aluminum panels fitting together seamlessly.
 - This helps to cool down the IPM, it has better performance compared to air cooling for PCB.
 - The outdoor unit has capability to run in max. 55°C ambient temperature.



AUTOMATICALLY ADDRESSING

- o Automatically addressing: system will distribute address to indoor unit automatically.
- o Automatic addressing will reduce artificial faults and manual works.



INDEPENDENT DISPLAY BOARD

Digital display



Digital display on the PCB, it can show system's operation status and error codes.

BLHV MINI

VRF SYSTEM

LOWER NOISE

- 5 Major Technology Leads to Lower Noise.
- The Min. noise level is 54 dB(A).

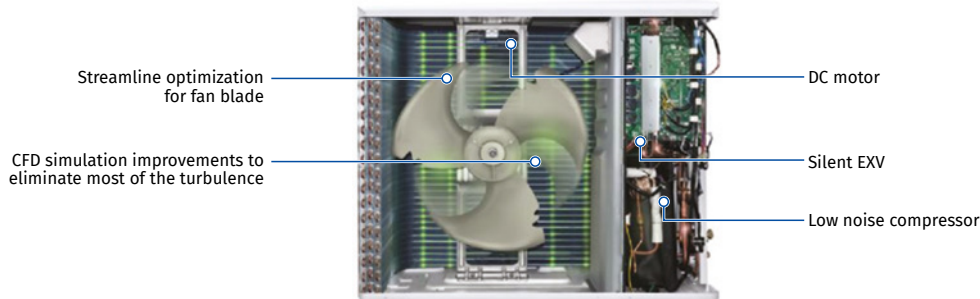

TECHNICAL DATA

Model Name			BLHV-R125-O/3R1A	BLHV-R140-O/3R1A	BLHV-R160-O/3R1A	BLHV-R180-O/3R1A	BLHV-R200-O/3R1A	BLHV-R224-O/3R1A	BLHV-R260-O/3R1A	BLHV-R280-O/3R1A	BLHV-R335-O/3R1A	
Power type (V/N/HZ)			380-415/3/50	380-415/3/50	380-415/3/50	380-415/3/50	380-415/3/50	380-415/3/50	380-415/3/50	380-415/3/50	380-415/3/50	
Cooling	Capacity	kW	12.5	14	16	18	20	22.4	26	28	33.5	
		Btu/h	42000	47800	54000	61000	68200	76400	88700	95500	114300	
	Power input	kW	3.38	3.80	4.53	5.18	5.92	6.75	7.54	8.31	9.46	
	EER		3.70	3.68	3.53	3.47	3.38	3.32	3.45	3.37	3.54	
Heating	Capacity	kW	14	16	18	20	22	24	28.5	31.5	37.5	
		Btu/h	47000	54000	61000	68000	75000	81800	97200	107500	128000	
	Power input	kW	3.26	3.97	4.61	5.02	5.35	5.62	6.77	8.18	8.99	
	COP		4.29	4.03	3.91	3.98	4.11	4.27	4.21	3.85	4.17	
Compressor	Type		DC/Twin-rotary									
	Qty		1									
Motor	Type		DC/fan motor									
	Qty		2									
Refrigerant	Type		R410a									
	Volume	kg	3.45	3.8	3.8	4.2	5.3	5.3	6.1	8	8	
Sound pressure Level		DB(A)	56	56	58	58	58	58	60	60	60	
Dimension (WxHxD)	Packing	mm	1010x1445x415				1095x1545x485			1278x1703x560		
	Body	mm	975x1335x400				1015x1430x450			1120x1549x528		
Weight	Net	kg	86.6	86.6	90.1	94.7	112.7	112.7	142	154	154	
	Gross	kg	96.4	96.4	100	104.4	126.8	126.8	162	174	174	
Connecting	Gas	mm	Ø 15.88	Ø 15.88	Ø 15.88	Ø 19.05	Ø 19.05	Ø 19.05	Ø 22.2	Ø 22.2	Ø 22.2	
	Liquid	mm	Ø 9.52	Ø 9.52	Ø 9.52	Ø 9.52	Ø 9.52	Ø 9.52	Ø 9.52	Ø 12.7	Ø 12.7	
Max Connected indoor units quantity			6	7	8	9	10	10	12	15	18	

- Cooling Operation Conditions: Indoor Air Inlet Temperature: 27°C DB / 19°C WB, T1: Outdoor Air Inlet Temperature: 35°C DB, T3: Outdoor Air Inlet Temperature: 46°C DB.
- Heating Operation Conditions: Indoor Air Inlet Temperature: 20.0°C DB, Outdoor Air Inlet Temperature: 7°C DB / 6°C WB.

BLHV MINI

VRF SYSTEM



8 / 10 / 12.5 / 14 / 16kW

FEATURES

COMPACT APPEARANCE

- o Easy for transportation.
- o It is suitable to be installed on terrace due to its compact appearance.



WIDE OUTDOOR OPERATION RANGE

- o Because of refrigerant cooling design, the cooling ambient temperature range is up to 55 °C.
- o Heating ambient temperature is down to -15 °C, in cold weather, BLHV Mini VRF has capability to heat the room continuously.

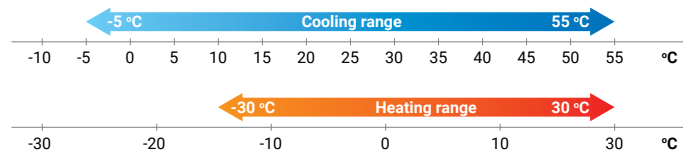

EASY MAINTENANCE WINDOW

- o LED display on the PCB: this is available to show operation status and error codes of the system.



BLHV MINI

VRF SYSTEM

TECHNICAL DATA

Model Name			BLHV-R080-O/1R1A	BLHV-R100-O/1R1A	BLHV-R125-O/1R1A	BLHV-R140-O/1R1A	BLHV-R160-O/1R1A
Power supply			220~240V/1N/ 50Hz	220~240V/1N/ 50Hz	220~240V/1N/ 50Hz	220~240V/1N/ 50Hz	220~240V/1N/ 50Hz
Cooling	Capacity	kW	8	10	12.5	14	16
		Btu/h	27300	34100	42600	47800	54600
	Power input	kW	2.60	3.00	3.20	3.75	4.75
	Rated current	A	11.8	13.6	14.5	17.0	21.8
	EER	W/W	3.08	3.33	3.91	3.73	3.37
Heating	Capacity	kW	9	11	14	16	17
		Btu/h	30700	37500	47800	54600	58000
	Power input	kW	2.65	3.1	3.52	4	4.4
	Rated current	A	12	14	16.1	18.2	20
	COP	W/W	3.40	3.55	3.98	4.00	3.86
DC Inverter compressor	Quantity		1				
	Type		Twin-rotary				
	Brand		Mitsubishi	GMCC	Mitsubishi	Mitsubishi	Mitsubishi
Fan motor	Type		DC				
	Qty		1				
	Power output	W	75	90	180	180	180
Fan blade	Fan Quantity		1				
	Air flow	m ³ /h	3300	4000	5500	5500	5500
Outdoor coil	Fin type		Hydrophilic Foil				
	Number of rows		3	2	2	3	3
	Tube type		Inner-grooved copper tube				
Refrigerant	Type		R410a				
	Volume	kg	2.00	2.60	3.00	3.45	3.80
Dimension (WxHxD)	Net	mm	935x702x383	1032x810x445	1100x870x528	1100x870x528	1100x870x528
	Packing	mm	975x770x420	1075x875x495	1140x965x540	1140x965x540	1140x965x540
Weight	Net	kg	47	60	85	90	90
	Gross	kg	50	65	95	100	100
ODU sound level		dB(A)	≤54	≤56	≤56	≤57	≤57
Cooling	Outdoor side	°C	-5~55				
Heating	Outdoor side	°C	-15~30				

1 The cooling conditions: indoor temp.: 27°C DB (80.6°C), 19°C WB (60°C) outdoor temp.: 35°C DB (95°C) equivalent pipe length: 5m drop length: 0m.

2 The heating conditions: indoor temp.: 20°C DB (68°C), 15 °C WB (44.6°C) outdoor temp.: 7°C DB (42.8°C) equivalent pipe length: 5m drop length: 0m.

3 Sound level: Anechoic chamber conversion value, measured at point 1 min front of the unit at a height of 1.2m. During actual operation, these values are normally somewhat higher as a result of ambient conditions.

4 The above data may be changed without notice for future improvement on quality at performance.



INDOOR UNITS



INDOOR UNITS

VRF SYSTEM

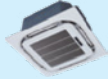
INDOOR UNITS LINE UP

Capacity (kW)	Round-flow cassette 	4-way cassette (Compact type) 	Wall-mounted 	Floor Ceiling 	Short ceiling concealed ducted unit 	Medium ESP ducted unit 	High ESP ducted unit 
2.2		•	•		•		
2.8		•	•		•		
3.6		•	•	•	•		
4.5		•	•	•	•		
5.6	•		•	•	•		
7.1	•		•	•	•	•	•
8.0	•			•		•	•
9.0	•			•		•	•
10.0	•					•	•
11.2	•			•			
12.0						•	•
12.5	•						
14.0	•					•	
15.0				•			•
16.0	•						
20.0							•
22.4							
25.0							•
28.0							•
45.0							•
56.0							•

INDOOR UNITS

VRF SYSTEM

4-WAY CASSETTE (COMPACT TYPE) ROUND-FLOW CASSETTE



CONTROL

Wireless	Wired	Wireless	Centralized
Standard	Optional	Optional	Optional

FEATURES

ACCESSORIES

Plenum box	Air filter	EXV	Drain pump	AC motor	DC motor
/	Standard	Standard(built-in)	Standard(built-in)	Standard	Optional

WIDE AIR DELIVERING

- Air flow is soft and smooth, air can be delivered to every corner without dead angle, it makes the room temperature distribution more balance.

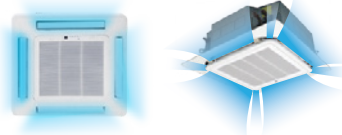

FRESH AIR INTAKE

- Four interfaces to connect with duct to another room.
- Fresh air intake, more healthy and comfortable.



360° ROUND PANEL IS STANDARD

- it has slim body with 230 mm height, it is specially suitable for low suspended ceiling rooms.

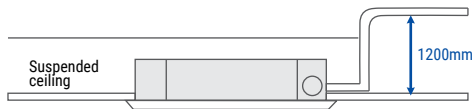

BUILT-IN WITH DRAINAGE PUMP

- Built-in with low noise long life drainage pump, pumping head is 1200mm, flexible for drainage pipe design.
- Note: The pumping head of 4-way cassette unit (compact type) is 700mm.



SPECIFICATION

4-way Cassette Unit (Compact type)			BLHV-22-I-C4-AC/1R1A	BLHV-28-I-C4-AC/1R1A	BLHV-36-I-C4-AC/1R1A	BLHV-45-I-C4-AC/1R1A
Power type			50Hz	50Hz	50Hz	50Hz
Capacity	Cooling	kW	2.2	2.8	3.6	4.5
		kBtu/h	7.5	9.5	12.2	15.3
	Heating	kW	2.5	3.2	4.0	5.0
		kBtu/h	8.5	10.9	13.6	17
Motor input	Quantity	kW	0.038	0.038	0.040	0.040
Air flow		m ³ /h	447	447	515	515
		CFM	263	263	303	303
Sound Level		DB(A)	22~34	22~34	27~38	27~38
ESP		Pa	/			
Dimension (WxHxD)	Packing	mm	745x375x675			
	Body	mm	653x267x585			
	Panel packing	mm	750x95x750			
	Panel	mm	650x30x650			
Body Weight	Net	kg	17.5	17.5	17.5	17.5
	Gross	kg	25	25	25	25
Connecting pipe	Gas	mm	Ø 9.53	Ø 9.53	Ø 12.7	Ø 12.7
	Liquid	mm	Ø 6.35			
	Drain	mm	OD Ø25			
Standard controller			Remote controller			

INDOOR UNITS

VRF SYSTEM

Round-flow Cassette			BLHV-56-I-CR-AC/1R1A	BLHV-71-I-CR-AC/1R1A	BLHV-80-I-CR-AC/1R1A
Power type			50Hz	50Hz	50Hz
Capacity	Cooling	kW	5.6	7.1	8.0
		kBtu/h	19.1	24.2	27.2
	Heating	kW	6.3	8.0	8.8
		kBtu/h	21.4	27.2	30
Motor input	Quantity	kW	0.09	0.18	0.18
Air flow	m ³ /h		860	1200	1200
	CFM		500	700	700
Sound Level	DB(A)		32~39	35~39	35~39
ESP	Pa		/		
Dimension (WxHxD)	Packing	mm	920x265x985		
	Body	mm	920x265x985		
	Panel packing	mm	1030x105x1030		
	Panel	mm	950x50x950		
Body Weight	Net	kg	24	24	24
	Gross	kg	30	30	30
Connecting pipe	Gas	mm	Ø 12.7	Ø 15.9	Ø 15.9
	Liquid	mm	Ø 6.5	Ø 9.52	Ø 9.52
	Drain	mm	Ø 25		
Standard controller			Remote controller		

Round-flow Cassette			BLHV-90-I-CR-AC/1R1A	BLHV-100-I-CR-AC/1R1A	BLHV-112-I-CR-AC/1R1A	BLHV-125-I-CR-AC/1R1A	BLHV-140-I-CR-AC/1R1A	BLHV-160-I-CR-AC/1R1A
Power type			50Hz	50Hz	50Hz	50Hz	50Hz	50Hz
Capacity	Cooling	kW	9.0	10	11.2	12.5	14	16
		kBtu/h	30.7	34.1	38.2	42.6	47.7	54.5
	Heating	kW	10	11	12.5	14	15	17
		kBtu/h	34.1	37.5	42.6	47.7	51.1	58
Motor input	Quantity	kW	0.18	0.18	0.18	0.18	0.27	0.27
Air flow	m ³ /h		1400	1400	1400	1400	1800	1800
	CFM		820	820	820	820	1050	1050
Sound Level	DB(A)		37~41	37~41	37~41	37~41	38~42	38~42
ESP	Pa		/					
Dimension (WxHxD)	Packing	mm	920x310x985					
	Body	mm	833x286x900					
	Panel packing	mm	1030x105x1030					
	Panel	mm	950x50x950					
Body Weight	Net	kg	28.5	28.5	28.5	28.5	28.5	28.5
	Gross	kg	35	35	35	35	35	35
Connecting pipe	Gas	mm	Ø 15.9	Ø 15.9	Ø 15.9	Ø 15.9	Ø 15.9	Ø 15.9
	Liquid	mm	Ø 9.52	Ø 9.52	Ø 9.52	Ø 9.52	Ø 9.52	Ø 9.52
	Drain	mm	Ø 25					
Standard controller			Remote controller					

1 Power supply: 220-240V/1N for 50Hz;208-230V/1N for 60Hz.

2 Cooling test condition: indoor side 27°C DB,19°C WB outdoor side 35°C DB.Heating test condition: indoor side 20°C DB, 15°C WB outdoor side 7°C DB.

3 Sound level: measured at a point 1 m in front of the unit at a height of 1.5m. During actual operation, these values are normally somewhat higher as a result of ambient conditions.

4 The above data may be changed without notice for future improvement on quality and performance.

INDOOR UNITS

VRF SYSTEM

SHORT CEILING CONCEALED DUCTED UNIT

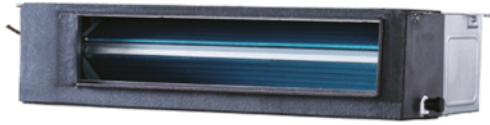

CONTROL

Wired	Wired	Wireless	Centralized
Standard	Optional	Optional	Optional

FEATURES

ACCESSORIES

Plenum box	Air filter	EXV	Drain pump	AC motor	DC motor
Standard	Optional	Standard(built-in)	Optional	Standard	Optional

FLEXIBLE INSTALLATION

- o Air return method is optional by actual installation, from rear or from bottom.

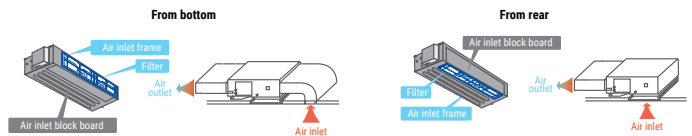

BIG AIR FLOW LOW NOISE CENTRIFUGAL FAN WHEEL

- o Big air flow low noise centrifugal fan blade with special air tunnel system, and the unique shock absorption measures, making this series ducted units' running noise is as low as 24 dB(A), let users to enjoy the comfort, sleep without any disturbance.



Rustled leaves



Silent reading room

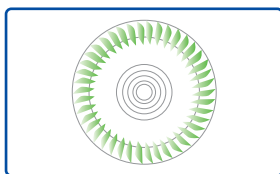

Special resin material fan wheel.



All vanes are dislocation distribution to offset sound wave, so that the noise can be reduced.

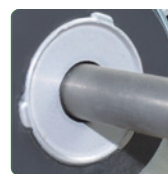

High efficiency low noise motor, motor and support frame with rubber ring isolation, can absorb vibration and reduce noise.

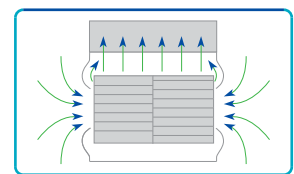

Air inlet of fan wheel casing is arch curved design; it can reduce air flow's disturbance, make it flow smoother to reduce noise.

SLIM BODY, EASY TO INSTALL

- o Has slim body with 210 mm height, it is specially suitable for low suspended ceiling rooms. suitable for low suspended ceiling rooms

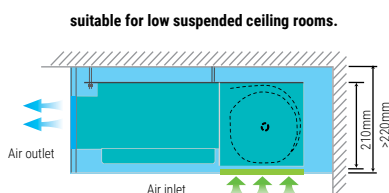

DRAIN PUMP IS OPTIONAL

- o Pumping head is 700 mm.

DC FAN MOTOR IS OPTIONAL

INTEGRATED DESIGN OF MOTOR AND MOTOR BRACKET, LOWER NOISE

INDOOR UNITS

VRF SYSTEM

SPECIFICATION

Short Ceiling Concealed Ducted Unit			BLHV-22-I-DL-AC/1R1A	BLHV-28-I-DL-AC/1R1A	BLHV-36-I-DL-AC/1R1A	BLHV-45-I-DL-AC/1R1A	BLHV-56-I-DL-AC/1R1A	BLHV-71-I-DL-AC/1R1A
Power type			50Hz	50Hz	50Hz	50Hz	50Hz	50Hz
Capacity	Cooling	kW	2.2	2.8	3.6	4.5	5.6	7.1
		kBtu/h	7.5	9.5	12.2	15.3	19.1	24.2
	Heating	kW	2.5	3.2	4	5	6.3	8
		kBtu/h	8.5	10.9	13.6	17	21.4	27.2
Motor input	Quantity	kW	0.05	0.05	0.07	0.08	0.09	0.11
Air flow		m ³ /h	450	450	550	620	800	1000
		CFM	260	260	324	360	520	640
Sound Level		DB(A)	24~29	24~29	25~32	32~37	28~38	30~39
ESP		Pa	30					
Dimension (WxHxD)	Packing	mm	910x240x510	910x240x510	910x240x510	910x240x510	1110x240x510	1310x240x510
	Body	mm	814x210x467	814x210x467	814x210x467	814x210x467	1010x210x467	1214x210x467
	Panel packing	mm	/					
	Panel	mm	/					
Body Weight	Net	kg	16	16	16.5	16.5	21	25.5
	Gross	kg	18.5	18.5	19	19	24	28.5
Connecting pipe	Gas	mm	Ø 9.53	Ø 9.53	Ø 12.7	Ø 12.7	Ø 12.7	Ø 15.9
	Liquid	mm	Ø 6.35	Ø 6.35	Ø 6.35	Ø 6.35	Ø 6.35	Ø 9.53
	Drain	mm	ODØ25					
Standard controller			Wired controller					

1 Power supply: 220-240V/1N for 50Hz;208-230V/1N for 60Hz.

2 Cooling test condition: indoor side 27°C DB,19°C WB outdoor side 35°C DB.Heating test condition: indoor side 20°C DB, 15°C WB outdoor side 7°C DB.

3 Sound level: measured at a point 1 m in front of the unit at a height of 1.5m. During actual operation, these values are normally somewhat higher as a result of ambient conditions.

4 The above data may be changed without notice for future improvement on quality and performance.

INDOOR UNITS VRF SYSTEM

MEDIUM ESP DUCTED UNIT

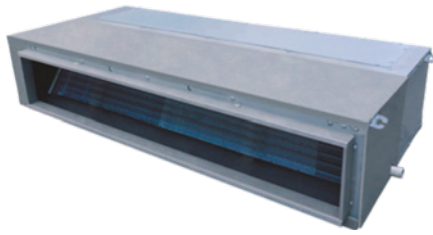

CONTROL

Wired	Wired	Wireless	Centralized
Standard	Optional	Optional	Optional

FEATURES

ACCESSORIES

Plenum box	Air filter	EXV	Drain pump	AC motor	DC motor
Standard	Standard	Standard	Optional	Standard	Optional

STATIC PRESSURE

- 70Pa ESP is standard, suitable for long distance air supply, 30Pa is optional (can be set on site), suitable for low noise requirement rooms

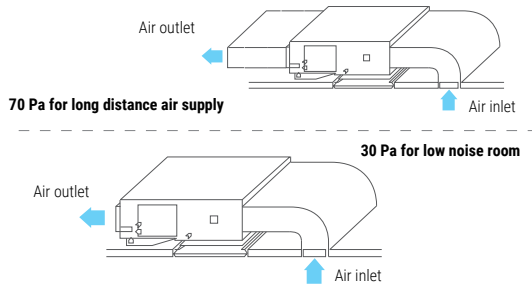

FRESH AIR INTAKE

- A reserved outside air intake port allows outdoor air to be introduced directly into the unit, no need for a separate ventilation system.

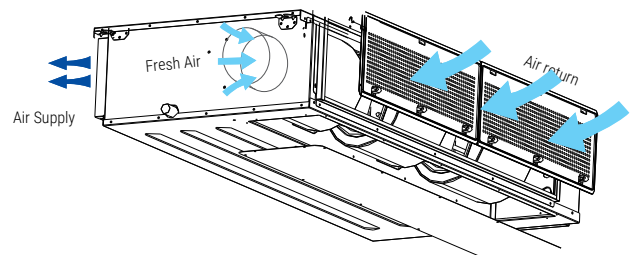

CONVENIENT IN DRAINAGE PIPE INSTALLATION

- Reserved drainage pipe outlet holes on left side and right side, installer can choose the outlet holes on site as per actual conditions, flexible for drainage pipe installation.

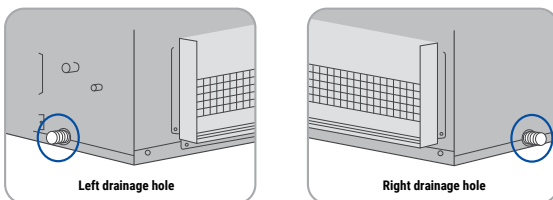

WHOLE UNIT LOW NOISE DESIGN, SILENT OPERATION

- Using multiple noise reduction technology, including the design of high efficiency low noise motor, aviation fan wheel, low vibration wheel casing, unique design, the inner wall configuration with high quality insulation materials, and so on, to make the units running in a low noise condition.
 - Aviation fan wheel, designed by the industry's top design software.
 - High quality insulation materials, effectively reducing noise diffusion
 - High efficiency low noise motor, motor and support frame with rubber ring isolation, can absorb vibration and reduce noise.
 - Wheel casing streamline design, reduce the airflow disturbance to lower the noise.

TWO AIR RETURN INSTALLATION METHODS

- Air return from rear or bottom is easy to change on site, convenient for installation.

DC FAN MOTOR IS OPTIONAL

- The power consumption of DC fan motor can be reduced greatly in comparison to corresponding AC type.

INDOOR UNITS

VRF SYSTEM

SPECIFICATION

Medium ESP Ducted Unit			BLHV-71-I-DM-AC/1R1A	BLHV-80-I-DM-AC/1R1A	BLHV-90-I-DM-AC/1R1A	BLHV-100-I-DM-AC/1R1A	BLHV-120-I-DM-AC/1R1A	BLHV-150-I-DM-AC/1R1A
Power type			50Hz	50Hz	50Hz	50Hz	50Hz	50Hz
Capacity	Cooling	kW	7.1	8.0	9.0	10.0	12.0	15.0
		kBtu/h	24.2	27.2	30.7	34.1	40.9	51.1
	Heating	kW	8.0	9.0	10.0	11.0	13.0	17.0
		kBtu/h	27.2	30.7	34.1	37.5	44.3	58
Motor input	Quantity	kW	0.30	0.30	0.34	0.34	0.34	0.34
Air flow	m ³ /h		1220	1220	1850	2000	2000	2000
	CFM		710	710	1080	1170	1170	1170
Sound Level	DB(A)		36~41	36~41	38~43	40~44	40~44	40~44
ESP	Pa		70					
Dimension (WxHxD)	Packing	mm	1255x325x720	1255x325x720	1490x325x720	1490x325x720	1490x325x720	1490x325x720
	Body	mm	1209x260x680	1209x260x680	1445x260x680	1445x260x680	1445x260x680	1445x260x680
	Panel packing	mm	/					
	Panel	mm	/					
Body Weight	Net	kg	33	33	46	46	46	46
	Gross	kg	37	37	50	50	50	50
Connecting pipe	Gas	mm	Ø15.9					
	Liquid	mm	Ø9.53					
	Drain	mm	ODØ25					
Standard controller			Wired controller					

1 Power supply: 220-240V/1N for 50Hz;208-230V/1N for 60Hz.

2 Cooling test condition: indoor side 27°C DB,19°C WB outdoor side 35°C DB.Heating test condition: indoor side 20°C DB, 15°C WB outdoor side 7°C DB.

3 Sound level: measured at a point 1 m in front of the unit at a height of 1.5m. During actual operation, these values are normally somewhat higher as a result of ambient conditions.

4 The above data may be changed without notice for future improvement on quality and performance.

INDOOR UNITS

VRF SYSTEM

HIGH ESP DUCTED UNIT



CONTROL

Wired	Wired	Wireless	Centralized
Standard	Optional	Optional	Optional

FEATURES

ACCESSORIES

Plenum box	Air filter	EXV	Drain pump	AC motor	DC motor
Standard	Standard	Standard	Optional	Standard	/

OPTIONAL WATER PUMP

- o Slim body, saving suspended ceiling spaces. And water pump is optional, pump head up to 700 mm.

HIGH STATIC PRESSURE

- o Big air flow with high static pressure, easy for large rooms duct design. Suitable for different shape of rooms.

CAN BE USED WITH VARIOUS DIFFUSERS

- o Used with various diffusers, meet for different kinds of decoration.

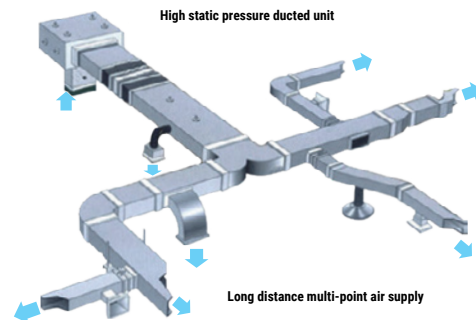

SPECIFICATION

High ESP Ducted Unit			BLHV-71-I-DH-AC/1R1A	BLHV-80-I-DH-AC/1R1A	BLHV-90-I-DH-AC/1R1A	BLHV-100-I-DH-AC/1R1A	BLHV-120-I-DH-AC/1R1A
Power type			50Hz	50Hz	50Hz	50Hz	50Hz
Capacity	Cooling	kW	7.1	8.0	9.0	10.0	12.0
		kBtu/h	24.2	27.2	30.7	34.1	40.9
	Heating	kW	7.8	8.8	10.0	11.0	13.0
		kBtu/h	26.6	30	34.1	37.5	44.3
Motor input	Quantity	kW	0.34	0.34	0.34	0.45	0.45
Air flow		m ³ /h	1500	1500	1500	2300	2300
		CFM	880	880	880	1350	1350
Sound Level		DB(A)	40~42	40~42	40~42	44~52	44~52
ESP		Pa	150	150	150	150	150
Dimension (WxHxD)	Packing	mm	1490x325x720	1490x325x720	1490x325x720	1245x445x655	1245x445x655
	Body	mm	1445x260x680	1445x260x680	1445x260x680	1190x370x620	1190x370x620
Body Weight	Net	kg	46	46	46	47	47
	Gross	kg	50	50	50	51	51
Connecting pipe	Gas	mm	Ø15.9	Ø15.9	Ø15.9	Ø15.9	Ø15.9
	Liquid	mm	Ø9.53	Ø9.53	Ø9.53	Ø9.53	Ø9.53
	Drain	mm			ØØ25		
Standard controller			Wired controller				

INDOOR UNITS

VRF SYSTEM

High ESP Ducted Unit			BLHV-150-I-DH-AC/1R1A	BLHV-200-I-DH-AC/1R1A	BLHV-250-I-DH-AC/1R1A	BLHV-280-I-DH-AC/1R1A	BLHV-450-I-DH-AC/1R1A	BLHV-560-I-DH-AC/1R1A	
Power type			50Hz	50Hz	50Hz	50Hz	50Hz	50Hz	
Capacity	Cooling	kW	15.0	20.0	25.0	28.0	45.0	56.0	
		kBtu/h	51.1	68.2	85.3	95.5	153.5	191.0	
	Heating	kW	17.0	22.0	27.5	30.8	50.0	63.0	
		kBtu/h	58.0	75.0	93.8	105.0	170.6	214.9	
Motor input	Quantity	kW	0.45	1.2	1.2	1.2	1.6	2.5	
Air flow	m ³ /h		2300	4000	4200	4400	6000	8000	
	CFM		1350	2350	2470	2580	3520	4700	
Sound Level	DB(A)		44~52	45~53	45~54	45~55	60	64	
ESP	Pa		150	150	150	150	200	200	
Dimension (WxHxD)	Packing	mm	1245x445x655	1245x445x655	1510x580x870	1510x580x870	2267x840x1050	2267x840x1050	
	Body	mm	1190x370x620	1465x448x811	1465x448x811	1465x448x811	2165x676x916	2165x676x916	
Body Weight	Net	kg	47	102	102	102	222	222	
	Gross	kg	51	113	113	113	260	260	
Connecting pipe	Gas	mm	Ø15.9	Ø22.2	Ø22.2	Ø22.2	Ø28.6	Ø28.6	
	Liquid	mm	Ø9.53	Ø12.7	Ø12.7	Ø12.7	Ø15.9	Ø15.9	
	Drain	mm	ODØ25	ODØ30	ODØ30	ODØ30	ODØ32	ODØ32	
Standard controller			Wired controller						

1 Power supply: 220-240V/1N for 50Hz;208-230V/1N for 60Hz.

2 Cooling test condition: indoor side 27°C DB,19°C WB outdoor side 35°C DB.Heating test condition: indoor side 20°C DB, 15°C WB outdoor side 7°C DB.

3 Sound level: measured at a point 1 m in front of the unit at a height of 1.5m. During actual operation, these values are normally somewhat higher as a result of ambient conditions.

4 The above data may be changed without notice for future improvement on quality and performance.

INDOOR UNITS

VRF SYSTEM

WALL MOUNTED UNIT



CONTROL

Wireless	Wired	Wireless	Centralized
Standard	Optional	Optional	Optional

FEATURES

ACCESSORIES

Plenum box	Air filter	EXV	Drain pump	AC motor	DC motor
/	Standard	Standard (built-in)	/	/	Standard

AIR SUPPLY SMOOTHLY

- o Cross flow fan, In Cooling mode, cold air is blown from horizontal. In heating mode, warm air is blown from vertical.

FLEXIBLE IN INSTALLATION

- o Refrigerant pipe can be connected from 3 directions.

2 PANELS CAN BE CHOSEN, SUITABLE FOR ALL KINDS OF DECORATION STYLE

- o Simple, elegant, stylish, mirror design, suitable for all kinds of decoration style.

HOTEL CARD FUNCTION

- o Hotel card interface is standard, which are designed to save energy by only running appliances while guest are present in their room.



INDOOR UNITS

VRF SYSTEM

SPECIFICATION

Medium ESP Ducted Unit			BLHV-22-I-W-DC/1R1A	BLHV-28-I-W-DC/1R1A	BLHV-36-I-W-DC/1R1A	BLHV-45-I-W-DC/1R1A	BLHV-56-I-W-DC/1R1A	BLHV-71-I-W-DC/1R1A
Power Supply			220-240V/1N/50&60Hz	220-240V/1N/50&60Hz	220-240V/1N/50&60Hz	220-240V/1N/50&60Hz	220-240V/1N/50&60Hz	220-240V/1N/50&60Hz
Capacity	Cooling	kW	2.2	2.8	3.6	4.5	5.6	7.1
	Heating	kW	2.5	3.2	4.0	5.0	6.3	8.0
Power input		W	15	15	18	20	23	35
Fan motor	Type		DC	DC	DC	DC	DC	DC
	Speed (Hi/Med/Low)	r/min	1000/900/870/850	1000/900/870/850	1100/1000/950/900	1050/950/900/850	1100/1000/950/900	1300/1200/1100/1000
Air flow		m ³ /h	440/380/360/350	440/380/360/350	500/440/415/380	655/610/565/525	720/645/580/560	890/805/720/645
Sound Level		DB(A)	24~33	24~33	27~36	29~38	32~42	35~43
Dimension (WxHxD)	Net	mm	864x300x200	864x300x200	864x300x200	972x320x215	972x320x215	972x320x215
	Packing	mm	945x375x290	945x375x290	945x375x290	1060x400x310	1060x400x310	1060x400x310
Body Weight	Net	kg	9.5	9.5	9.5	11.5	11.5	11.5
	Gross	kg	12	12	12	14	14	14
Refrigerant type			R410A	R410A	R410A	R410A	R410A	R410A
Throttle type			EXV	EXV	EXV	EXV	EXV	EXV
Connecting pipe	Gas	mm	Ø9.53	Ø9.53	Ø12.7	Ø12.7	Ø12.7	Ø15.88
	Liquid	mm	Ø6.35	Ø6.35	Ø6.35	Ø6.35	Ø6.35	Ø9.52
	Drain	mm	Ø20					
Operation temperature		°C	16~32					

1 Power supply: 220-240V/1N for 50Hz;208-230V/1N for 60Hz.

2 Cooling test condition: indoor side 27°C DB,19°C WB outdoor side 35°C DB.Heating test condition: indoor side 20°C DB, 15°C WB outdoor side 7°C DB.

3 Sound level: measured at a point 1 m in front of the unit at a height of 1.5m. During actual operation, these values are normally somewhat higher as a result of ambient conditions.

4 The above data may be changed without notice for future improvement on quality and performance.

INDOOR UNITS VRF SYSTEM

FLOOR CEILING UNIT



CONTROL

Wireless	Centralized	Wireless	Wired
			
Standard	Optional	Optional	Optional

FEATURES

ACCESSORIES

Plenum box	Air filter	EXV	Drain pump	AC motor	DC motor
/	Standard	Standard(built-in)	Optional	Standard	Optional

FLEXIBLE INSTALLATION

- According to actual project needs, choose ceiling suspended installation or floor standing installation.



WIDE ANGLE AIR SUPPLY

- Configured with low noise high performance centrifugal fans, has big air flow and long distance air supply.
- 3 dimensional air supply, wide air supply angle, easily supply to every corners.
- In Cooling mode, cold air is blown from horizontal.
- In heating mode, warm air is blown from vertical.

EASY FOR INSTALLTION

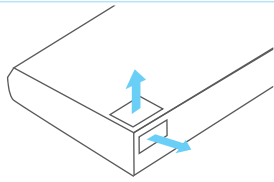

Refrigerant pipe can be connected from 2 directions.

Electrical control box is in the rear of fan wheel casing, easy to remove, convenient for maintenance.

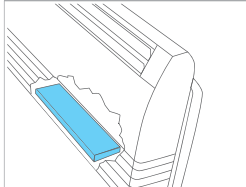

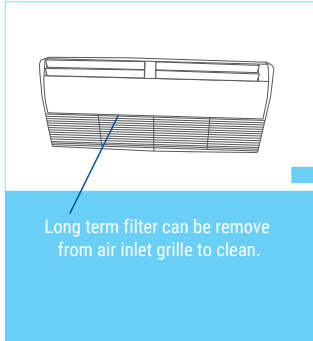

Long term filter can be remove from air inlet grille to clean.

Water washable

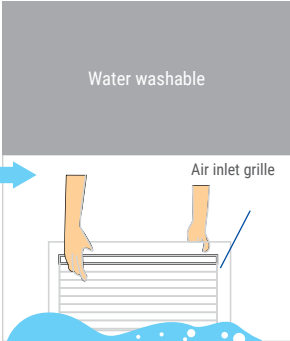

Air inlet grille

EASY FOR INSTALLTION

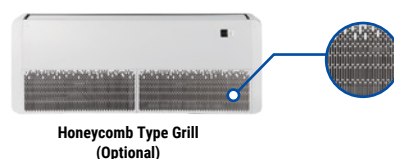

INDOOR UNITS

VRF SYSTEM

SPECIFICATION

Floor Ceiling Unit			BLHV-36-I-FC-AC/1R1A	BLHV-45-I-FC-AC/1R1A	BLHV-56-I-FC-AC/1R1A	BLHV-71-I-FC-AC/1R1A	BLHV-80-I-FC-AC/1R1A
Power type			50Hz	50Hz	50Hz	50Hz	50Hz
Capacity	Cooling	kW	3.6	4.5	5.6	7.1	8.0
		kBtu/h	12.3	15.3	19.1	24.2	27.2
	Heating	kW	4.0	5.0	6.3	8.0	8.8
		kBtu/h	13.7	17	21.4	27.2	30
Motor input	Quantity	kW	0.09	0.09	0.09	0.10	0.10
Air flow		m ³ /h	800	800	800	1200	1200
		CFM	470	470	470	706	706
Sound Level		DB(A)	32~46	32~46	32~46	41~48	41~48
Dimension (WxHxD)	Packing	mm	1130x765x330	1130x765x330	1130x765x330	1380x765x330	1380x765x330
	Body	mm	1050x675x235	1050x675x235	1050x675x235	1300x675x235	1300x675x235
Body Weight	Net	kg	26.5	26.5	26.5	32.5	32.5
	Gross	kg	31.5	31.5	31.5	37.5	37.5
Connecting pipe	Gas	mm	Ø12.7	Ø12.7	Ø12.7	Ø15.9	Ø15.9
	Liquid	mm	Ø6.35	Ø6.35	Ø6.35	Ø9.52	Ø9.52
	Drain	mm	DN20				
Standard controller			Remote controller				

Floor Ceiling Unit			BLHV-90-I-FC-AC/1R1A	BLHV-112-I-FC-AC/1R1A	BLHV-140-I-FC-AC/1R1A	BLHV-160-I-FC-AC/1R1A
Power type			50Hz	50Hz	50Hz	50Hz
Capacity	Cooling	kW	9.0	11.2	14.0	16.0
		kBtu/h	30.7	38.2	47.7	54.5
	Heating	kW	10.0	12.5	15	17
		kBtu/h	34.1	42.6	51.1	58
Motor input	Quantity	kW	0.20	0.20	0.20	0.20
Air flow		m ³ /h	2000	2000	2000	2000
		CFM	1177	1177	1177	1177
Sound Level		DB(A)	38~53	38~53	38~53	38~53
Dimension (WxHxD)	Packing	mm	1750x765x330	1750x765x330	1750x765x330	1750x765x330
	Body	mm	1670x675x235	1670x675x235	1670x675x235	1670x675x235
Body Weight	Net	kg	41.0	41.0	41.0	41.0
	Gross	kg	47.0	47.0	47.0	47.0
Connecting pipe	Gas	mm	Ø15.9	Ø15.9	Ø15.9	Ø15.9
	Liquid	mm	Ø9.52	Ø9.52	Ø9.52	Ø9.52
	Drain	mm				
Standard controller						

1 Power supply: 220-240V/1N for 50Hz;208-230V/1N for 60Hz.

2 Cooling test condition: indoor side 27°C DB,19°C WB outdoor side 35°C DB.Heating test condition: indoor side 20°C DB, 15°C WB outdoor side 7°C DB.

3 Sound level: measured at a point 1 m in front of the unit at a height of 1.5m. During actual operation, these values are normally somewhat higher as a result of ambient conditions.

4 The above data may be changed without notice for future improvement on quality and performance.

CONTROLLERS

VRF SYSTEM

WIRED CONTROLLERS

- Bidirectional communication. Indoor unit's operating parameters (error code, temperature, address) can be inquired and displayed on the controller.
- Compact design
- Timer function
- Fahrenheit/centigrade setting
- Address setting
- Press button tone setting



BL-SP-W06T

TOUCH SCREEN WIRED CONTROLLER

- Air filter cleaning reminding function.
- Touch screen with black background and blue light.
- Ultra thin body and stylish design meet high-end environments.
- On/off, temperature setting, fan speed setting, mode setting, timer and check function.



BL-SP-W07T

SIMPLE CENTRALIZED CONTROLLER

- Easy to install. Controller connects to outdoor units only.
- 1 Controller can control max. 100 indoor units.
- Mode lock function, user can lock the running mode of indoor unit.
- Build in Modbus protocol.

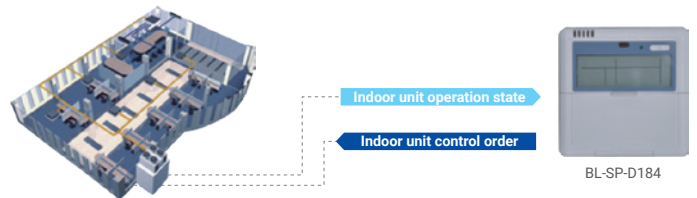

BL-SP-D184

SMART MANAGER

- Available on iOS and Android
- Remote control via cloud server
- Single unit controller or group control
- Weekly schedule management
- 100 indoor units can be controlled
- Operation parameter enquiry

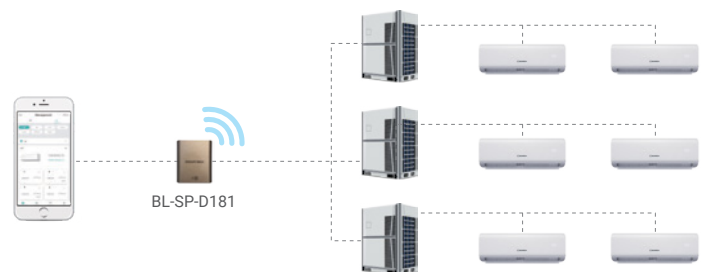

BL-SP-D181

TOUCH SCREEN CENTRALIZED CONTROLLER

- Build in WIFI modular
- Build in Modbus protocol
- Weekly schedule management
- Operation parameter enquiry
- User friendly UI design

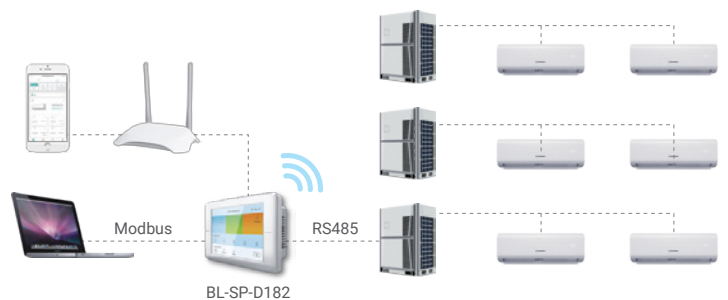

BL-SP-D182

BMS GATEWAY

- Modbus gateway
 - Independent Modbus Box or built-in with outdoor unit.
- BACnet gateway
 - Connect with Modbus gateway, use BACnet IP protocol.

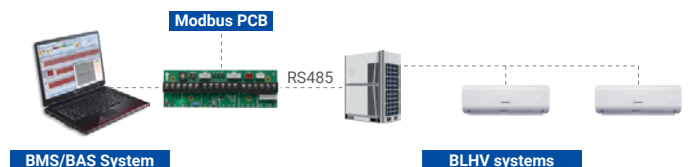

BMS/BAS System

BLHV systems

CONTROLLERS

VRF SYSTEM

CHV-NET(CENTRALIZED CONTROL SYSTEM)

- o Centralized control
- o Electricity charge management
- o Operation data record
- o Schedule management

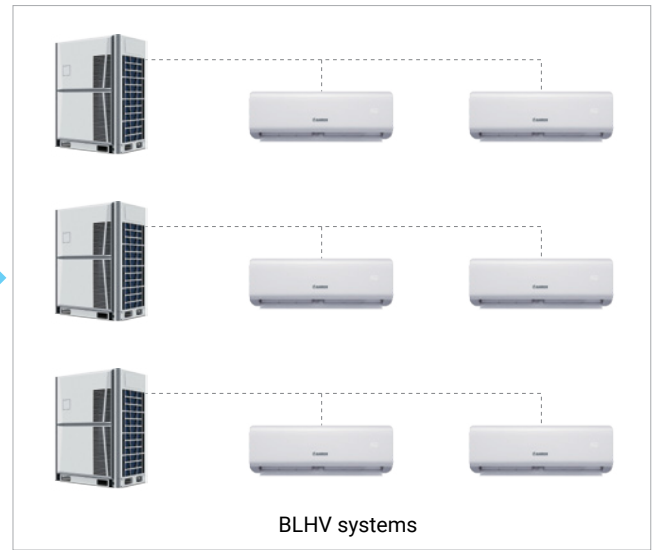
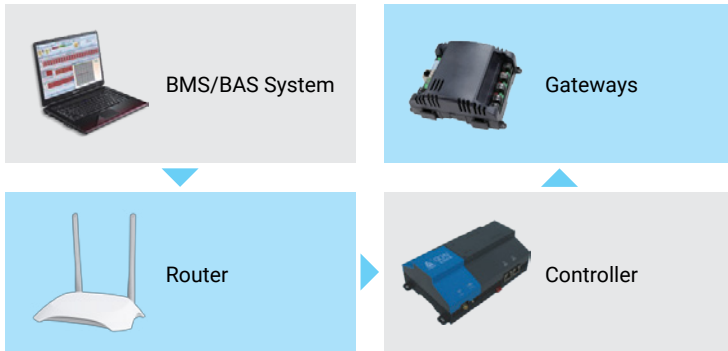

AHU CONNECTION KIT

- o BLHV AHU kit is an interface that allows 3rd party manufacturer's AHU connecting to GCHV VRF outdoor units.
- o No address limit and automatic addressing.
- o Split type, convenient for installation.
- o One electrical part has one address and can max. connect 4 EXV parts.
- o One AHU kit can max. connect up to 120HP.

Electrical part	EXV part	Sensors & wires	Controller
<ul style="list-style-type: none"> • PCB • Power terminals • Communication terminals 	<ul style="list-style-type: none"> • Outlet pipe • Inlet pipe • EXV 	<ul style="list-style-type: none"> • T1 sensor and wire • T2 sensor and wire • T2B sensor and wire • Controller wire 	

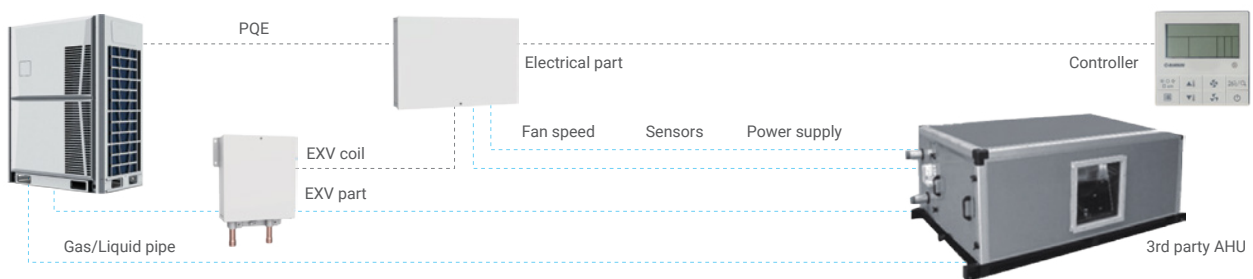

VRF SELECTION SOFTWARE

- o The selection software provides a comprehensive selection of system design reports and calculations. Base on the units selected, the software produces detailed system layout and piping requirement calculations, greatly improves the work efficiency.



Piping diagram

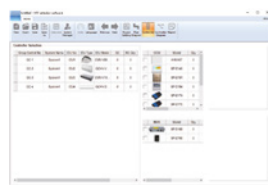

Controller selection



Wiring diagram

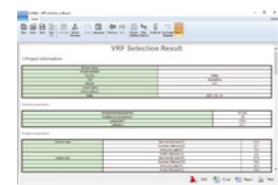

Report

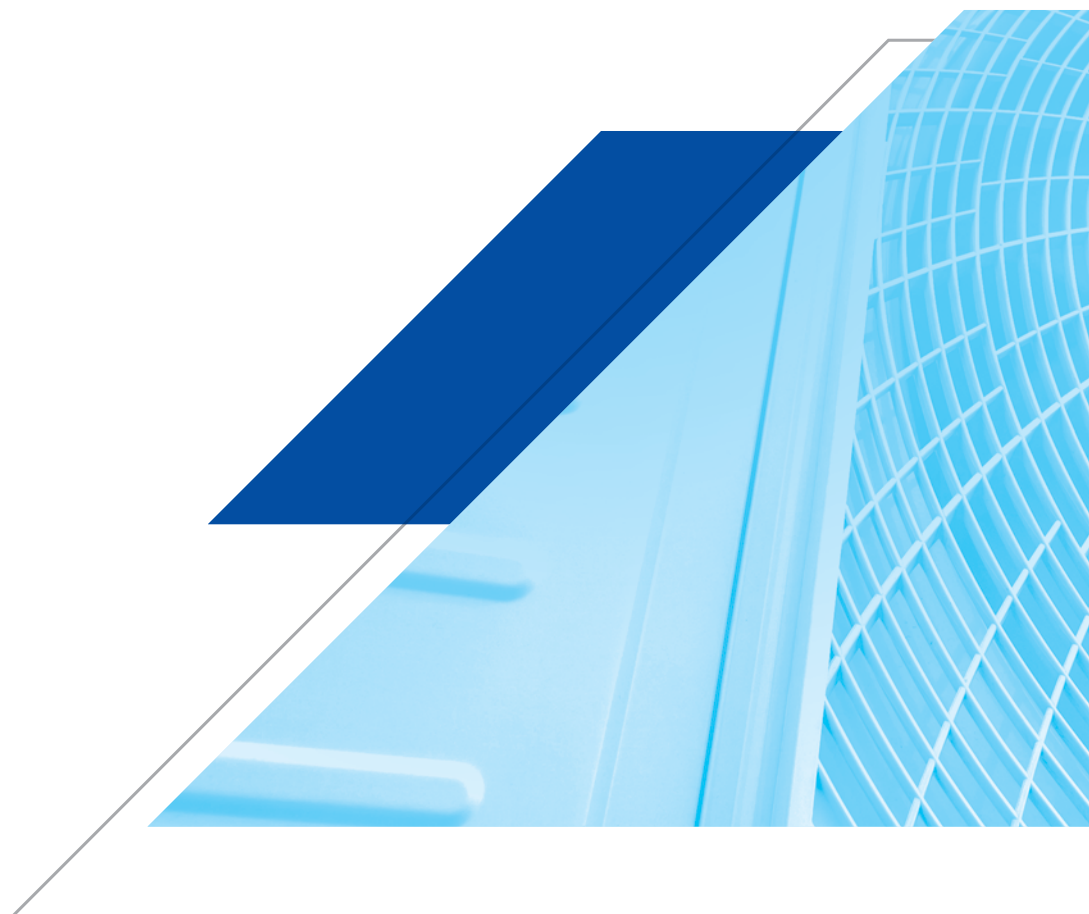

Blauberg Ventilatoren GmbH
Aidenbachstr. 52
D-81379 Munich

info@blaubergventilatoren.de
www.blaubergventilatoren.de

Technical changes reserved.
Illustrations and texts are non-binding.

04/2023