

# BLAUBOX EC MW

## Supply ventilation units

### Features

- Ventilation unit for efficient supply ventilation in various premises.
- Controllable air supply, heating and filtration.
- BMS connection via ModBUS RTU.



**Air flow:**  
up to 4950 m<sup>3</sup>/h  
1375 l/s



### Design

- Steel casing covered with aluzinc coating internally filled with 30 mm heat- and sound-insulating layer made of mineral wool.
- Mounting brackets with anti-vibration rubber. Service panel ensures easy access to the internals.
- **Blaubox EC MW 700** is compatible with round ducts.



Blaubox EC MW 700

### Blaubox EC ME 300 ... 700

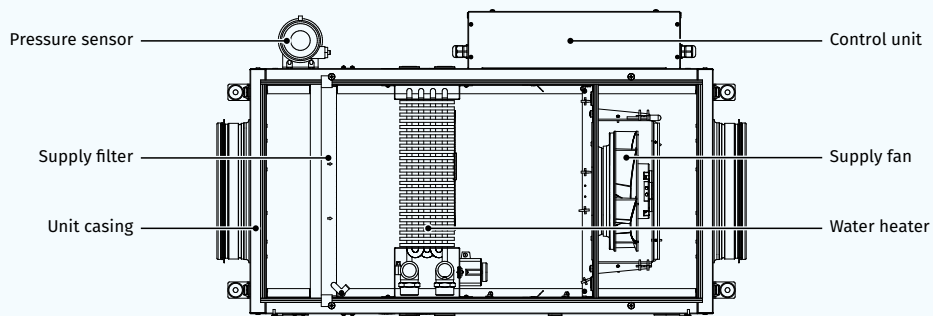

### Blaubox EC ME 1000 ... 4000

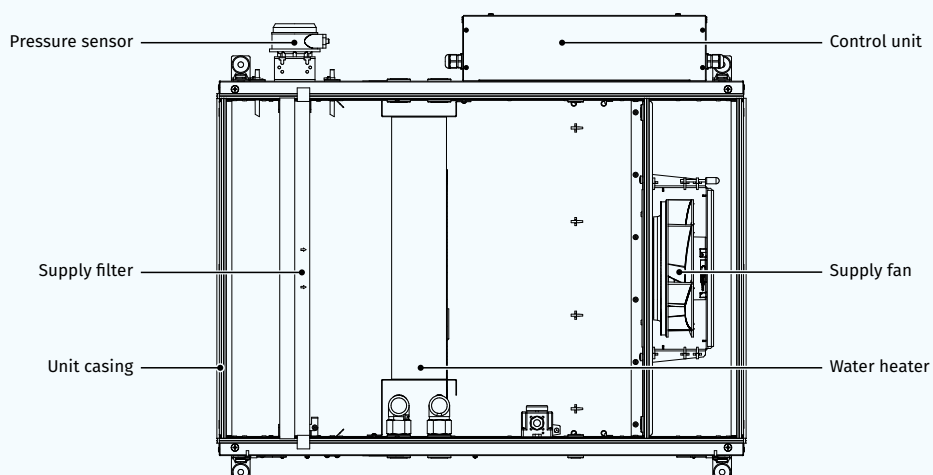

### Fans

- o Efficient external rotor EC-motors and centrifugal impellers with backward curved blades.
- o EC-motors are featured with high performance, low noise level and totally controllable speed range.
- o Dynamically balanced impeller.

### Air filtration

- o Panel Coarse 60% (G4) filter for supply air purification.
- o Panel ePM10 90% (F7) filter is available as an option.

### Air heater

- o The unit is equipped with a water heater.
- o Integrated frost protection.



### Mounting

- o The unit is suitable for indoor mounting on the floor, ceiling mounting or wall mounting with fixing brackets in any mounting position, except for the vertical one with air flow downward.
- o The correctly mounted unit must provide free access to the service panel.

### Control and automation

- o The units are equipped with an S31 integrated automation control system.
- o Remote control panels are not included in the delivery set and ordered separately.

### Automation functions

Functions	Description
Wired control panel	S30 
Wired control panel	S32 
Unit on / off	+
Fan speed control and setting	+
Filter clogging indication and control	Pressure sensor
Week schedule	+
Electric heater protection with auto restart	+
Electric heater protection with manual restart	+
Supply temperature control	+
Outer temperature sensor	+
Water heater frost protection	+
Return temperature sensor	+
Air damper control	+
Alarm indication	+
BMS Connection	ModBUS (RTU)
Humidity sensor	0-10 V or NO
CO <sub>2</sub> Sensor	0-10 V or NO
Exhaust fan control	on / off
Three-way valve control	+
Circulation pump control	+
Condensing unit control	0-10 V

### Designation key

Series	Motor type	Heater type	Rated air flow [m <sup>3</sup> /h]	Service side	Control
Blaubox: supply air unit	EC: electronically commutated motor	MW: water	300; 400; 700; 1000; 1500; 2000; 3000; 4000	L: left R: right	S31

**Overall dimensions [mm]**

Model	∅ D	H	H1	H2	L	L1	L2	L3	W	W1	W2	W3
Blaubox EC MW 700 S31	250	350	218	-	850	903	972	65	460	565	-	-
Blaubox EC MW 1000 S31	-	380	200	250	900	770	65	-	600	653	746	400
Blaubox EC MW 1500 S31	-	440	250	318	900	770	65	-	700	754	847	500
Blaubox EC MW 2000 S31	-	440	300	318	900	770	65	-	700	754	847	500
Blaubox EC MW 3000 S31	-	500	300	368	1200	1070	65	-	800	853	944	600
Blaubox EC MW 4000 S31	-	550	400	380	1200	1070	65	-	940	993	1087	700

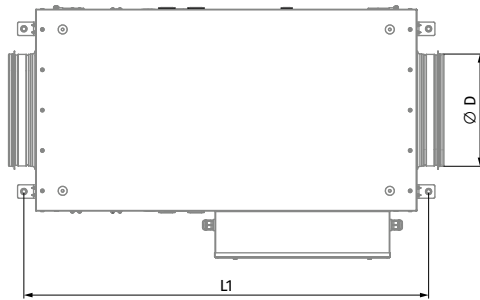
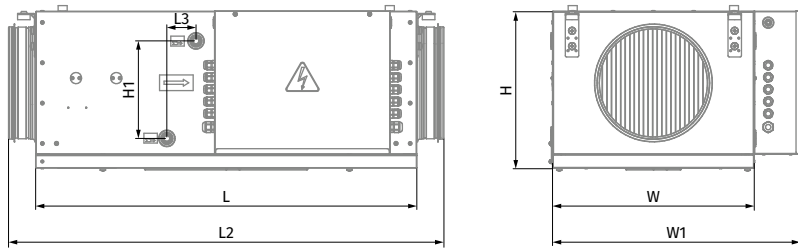

**Blaubox EC MW 700**

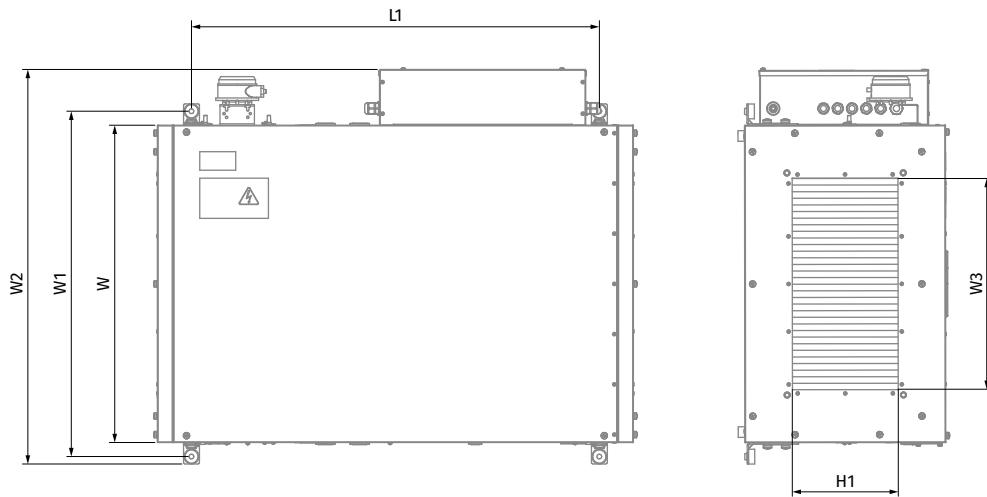

**Blaubox EC MW 1000 – Blaubox EC MW 4000**

**Technical data**

Parameters	Blaubox EC MW 700 S31	Blaubox EC MW 1000 S31
Supply voltage [V / 50 Hz]	1 ~ 230	1 ~ 230
Number of water coil rows	4	4
Water coil connection diameter [in]	3/4	1
Max. unit power [kW]	0.139	0.165
Max. unit current [A]	1.05	1.23
Maximum airflow [m³/h]	800	920
Max. water temperature [°C]	150	150
Sound pressure level at 3 m [dBA]	44	48
Transported air temperature [°C]	-30...+40	-30...+40
Casing material	aluzinc	aluzinc
Insulation	30 mm mineral wool	30 mm mineral wool
Filter	Coarse 90% / G4 (option: ePM1 70% / F7)	Coarse 90% / G4 (option: ePM1 70% / F7)
Connected air duct diameter [mm]	250	400 x 200
Weight [kg]	27	35

**BLAUBOX EC MW 700 S31**

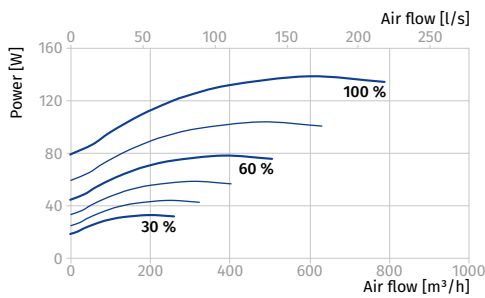
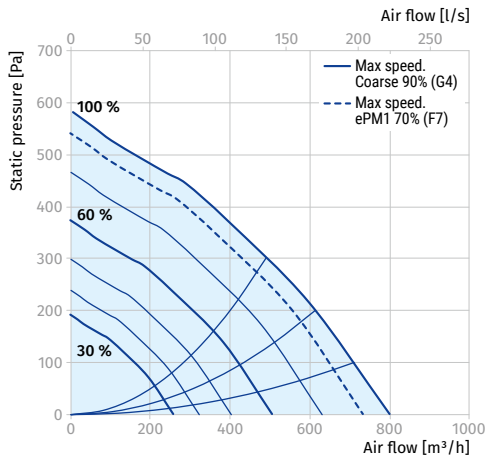

**BLAUBOX EC MW 1000 S31**

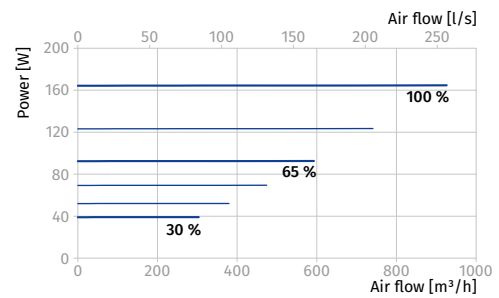
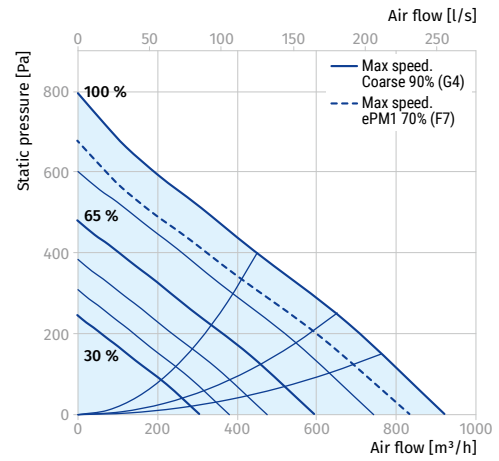

Parameters	Blaubox EC MW 1500 S31	Blaubox EC MW 2000 S31
Supply voltage [V / 50 Hz]	1 ~ 230	1 ~ 230
Number of water coil rows	4	4
Water coil connection diameter [in]	1	1
Max. unit power [kW]	0.222	0.387
Max. unit current [A]	1.6	1.7
Maximum airflow [m <sup>3</sup> /h]	1445	2150
Max. water temperature [°C]	150	150
Sound pressure level at 3 m [dBA]	49	53
Transported air temperature [°C]	-30...+40	-30...+40
Casing material	aluzinc	aluzinc
Insulation	30 mm mineral wool	30 mm mineral wool
Filter	Coarse 90% / G4 (option: ePM1 70% / F7)	Coarse 90% / G4 (option: ePM1 70% / F7)
Connected air duct diameter [mm]	500 × 250	500 × 300
Weight [kg]	49	45

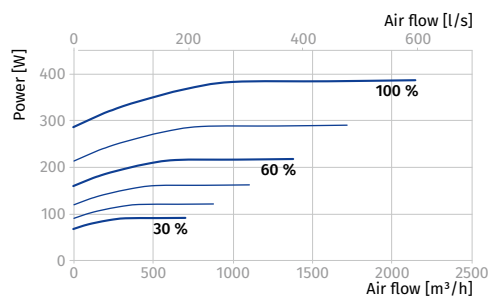
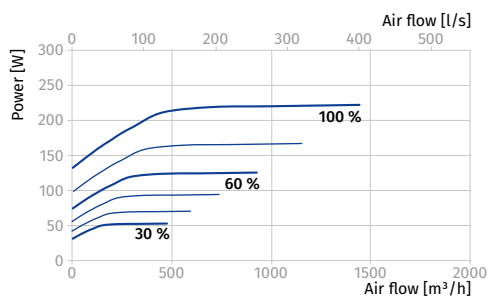
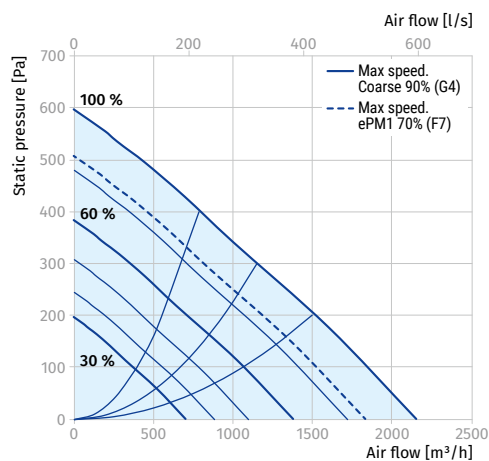
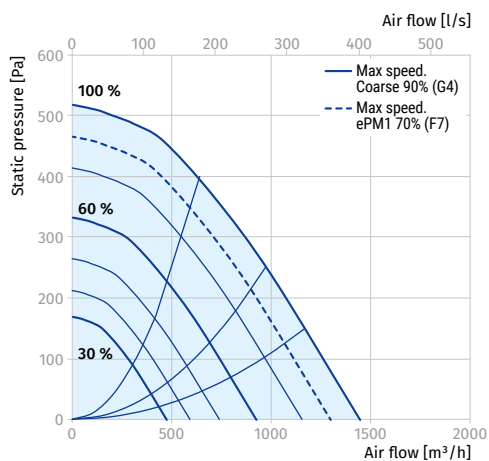
**BLAUBOX EC MW 1500 S31**
**BLAUBOX EC MW 2000 S31**

Parameters	Blaubox EC MW 3000 S31	Blaubox EC MW 4000 S31
Supply voltage [V / 50 Hz]	1 ~ 230	1 ~ 230
Number of water coil rows	4	4
Water coil connection diameter [in]	1 1/8	1 3/8
Max. unit power [kW]	0.425	0.698
Max. unit current [A]	1.8	1.06
Maximum airflow [m³/h]	2930	4950
Max. water temperature [°C]	150	150
Sound pressure level at 3 m [dBA]	52	54
Transported air temperature [°C]	-30...+40	-30...+40
Casing material	aluzinc	aluzinc
Insulation	30 mm mineral wool	30 mm mineral wool
Filter	Coarse 90% / G4 (option: ePM1 70% / F7)	Coarse 90% / G4 (option: ePM1 70% / F7)
Connected air duct diameter [mm]	600 × 300	700 × 400
Weight [kg]	50	58

**BLAUBOX EC MW 3000 S31**

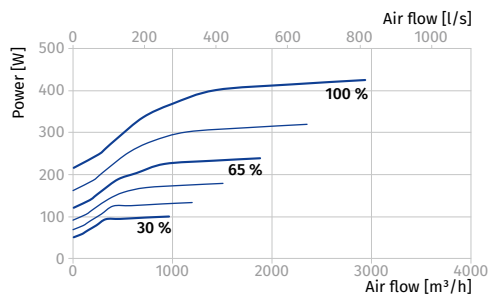
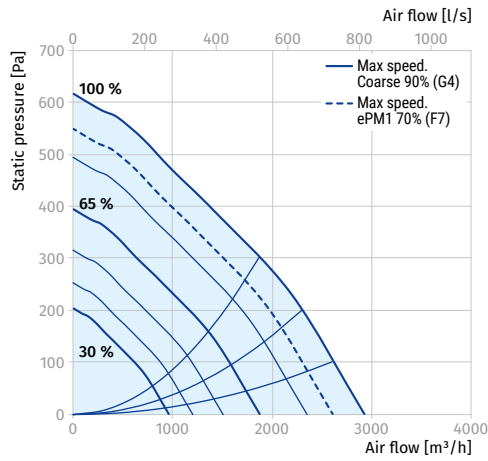

**BLAUBOX EC MW 4000 S31**

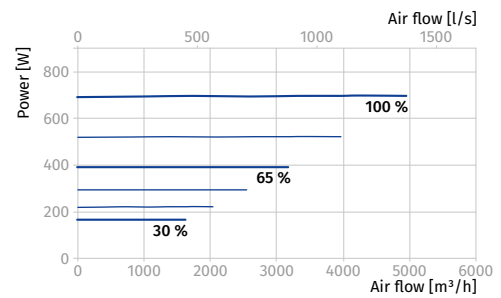
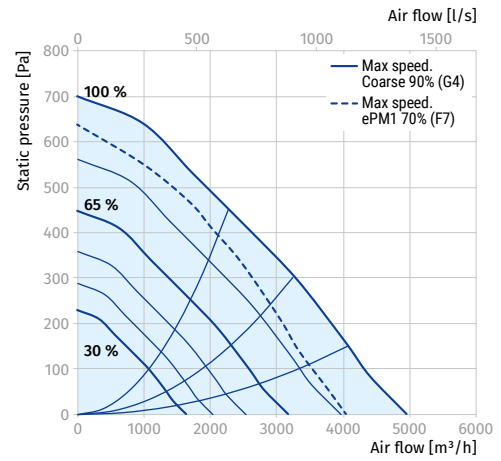

## Hot water coil calculation diagram

### BLAUBOX EC MW 700 S31

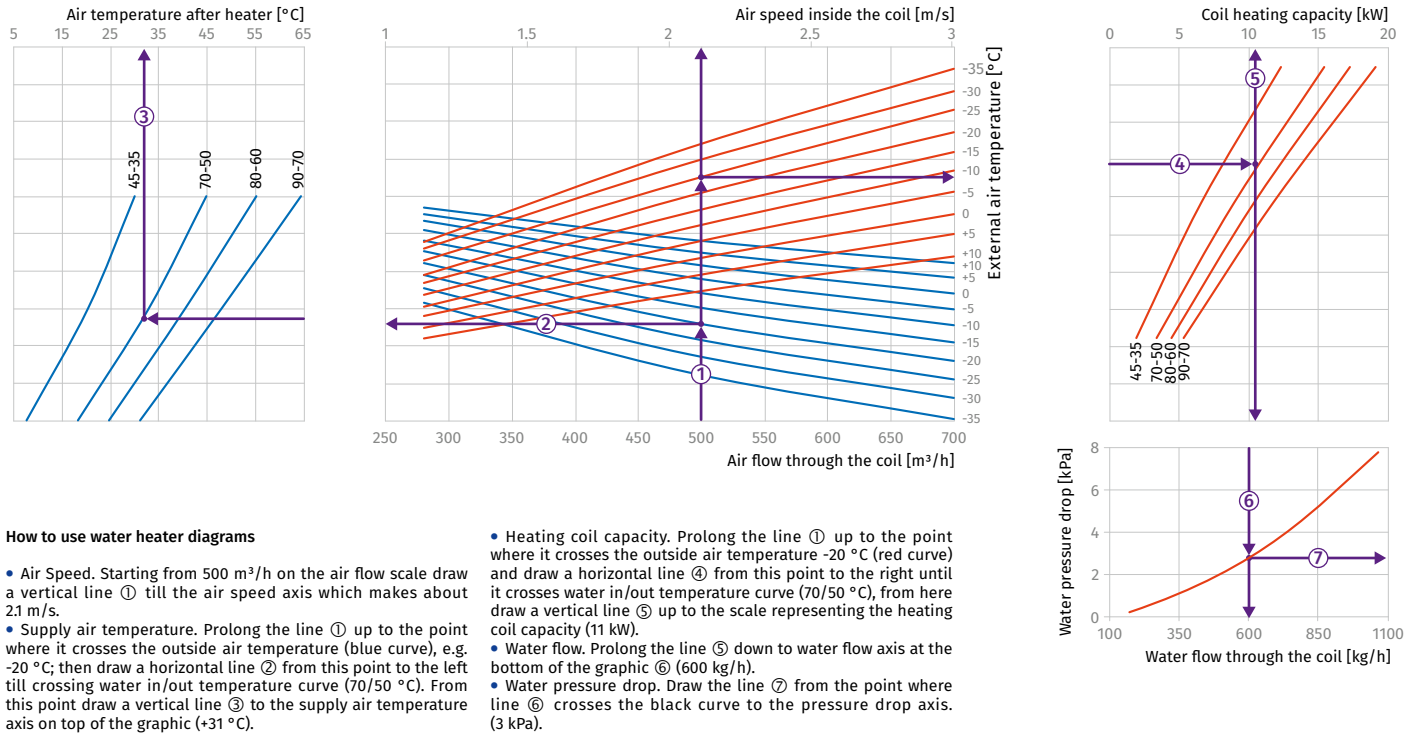

### BLAUBOX EC MW 1000 S31

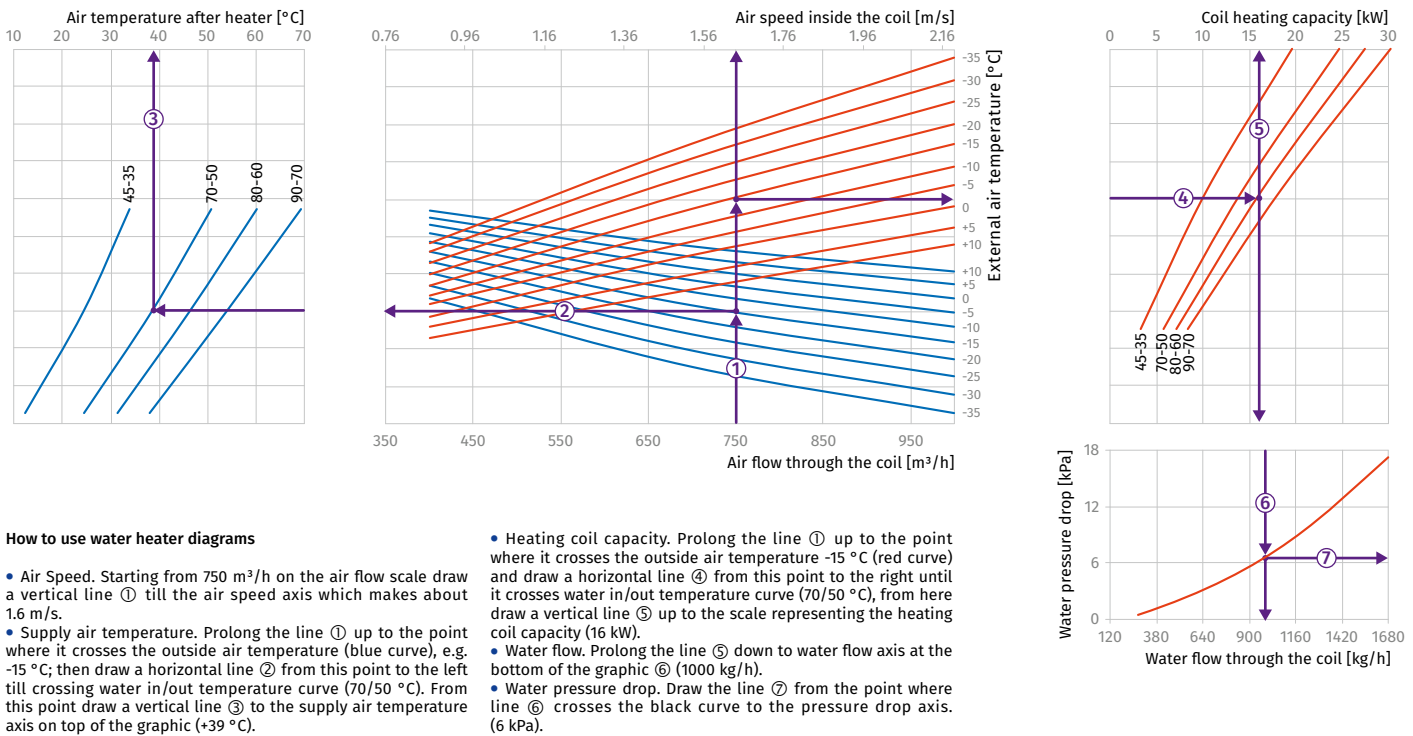

### BLAUBOX EC MW 1500 S31

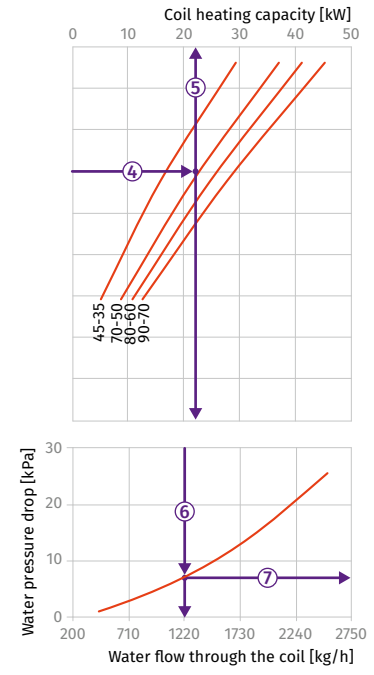
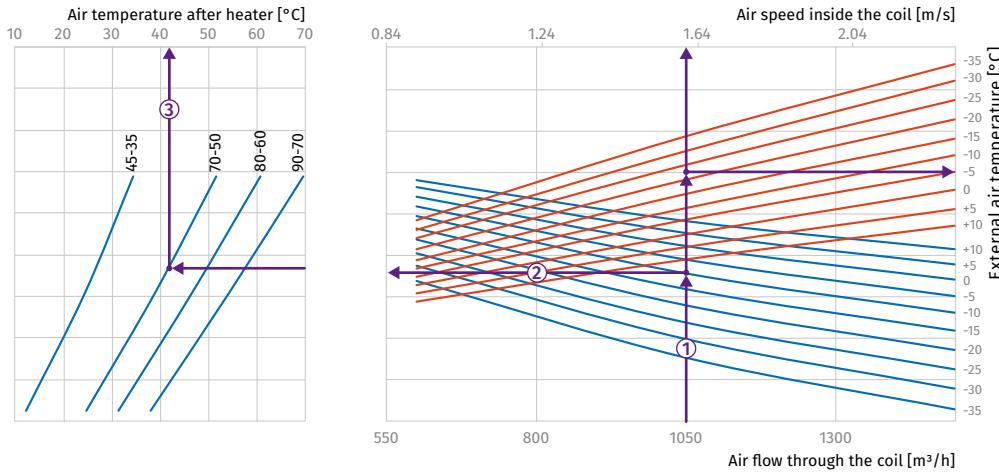

#### How to use water heater diagrams

- Air Speed. Starting from 1050 m<sup>3</sup>/h on the air flow scale draw a vertical line ① till the air speed axis which makes about 1.6 m/s.
- Supply air temperature. Prolong the line ① up to the point where it crosses the outside air temperature (blue curve), e.g. -10 °C; then draw a horizontal line ② from this point to the left till crossing water in/out temperature curve (70/50 °C). From this point draw a vertical line ③ to the supply air temperature axis on top of the graphic (+41 °C).

- Heating coil capacity. Prolong the line ① up to the point where it crosses the outside air temperature -15 °C (red curve) and draw a horizontal line ④ from this point to the right until it crosses water in/out temperature curve (70/50 °C), from here draw a vertical line ⑤ up to the scale representing the heating coil capacity (22 kW).
- Water flow. Prolong the line ⑤ down to water flow axis at the bottom of the graphic ⑥ (1220 kg/h).
- Water pressure drop. Draw the line ⑦ from the point where line ⑥ crosses the black curve to the pressure drop axis. (8.5 kPa).

### BLAUBOX EC MW 2000 S31

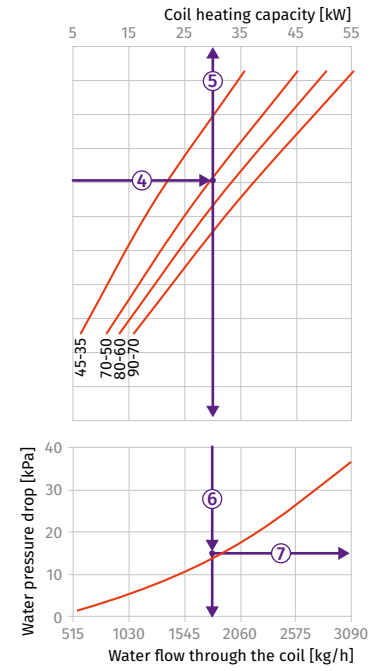
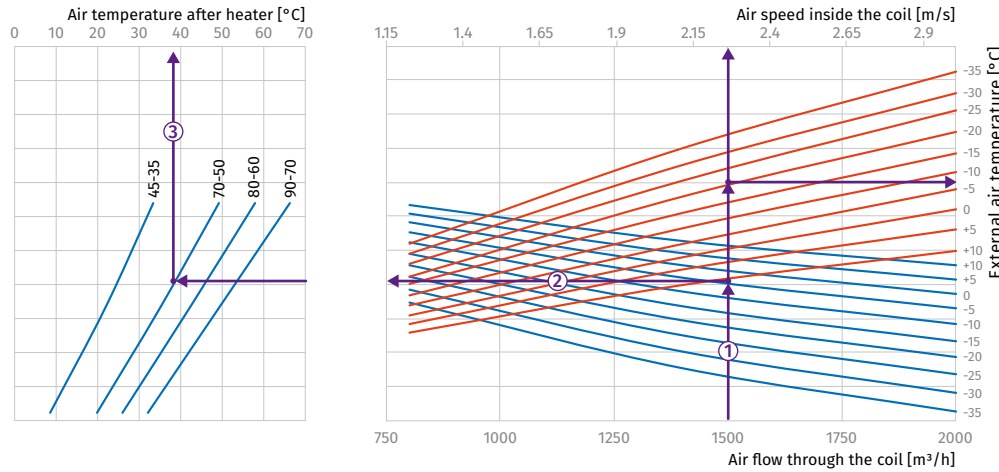

#### How to use water heater diagrams

- Air Speed. Starting from 1500 m<sup>3</sup>/h on the air flow scale draw a vertical line ① till the air speed axis which makes about 2.25 m/s.
- Supply air temperature. Prolong the line ① up to the point where it crosses the outside air temperature (blue curve), e.g. -5 °C; then draw a horizontal line ② from this point to the left till crossing water in/out temperature curve (70/50 °C). From this point draw a vertical line ③ to the supply air temperature axis on top of the graphic (+38 °C).

- Heating coil capacity. Prolong the line ① up to the point where it crosses the outside air temperature -15 °C (red curve) and draw a horizontal line ④ from this point to the right until it crosses water in/out temperature curve (70/50 °C), from here draw a vertical line ⑤ up to the scale representing the heating coil capacity (30 kW).
- Water flow. Prolong the line ⑤ down to water flow axis at the bottom of the graphic ⑥ (1750 kg/h).
- Water pressure drop. Draw the line ⑦ from the point where line ⑥ crosses the black curve to the pressure drop axis. (15 kPa).



**BLAUBOX EC MW 3000 S31**

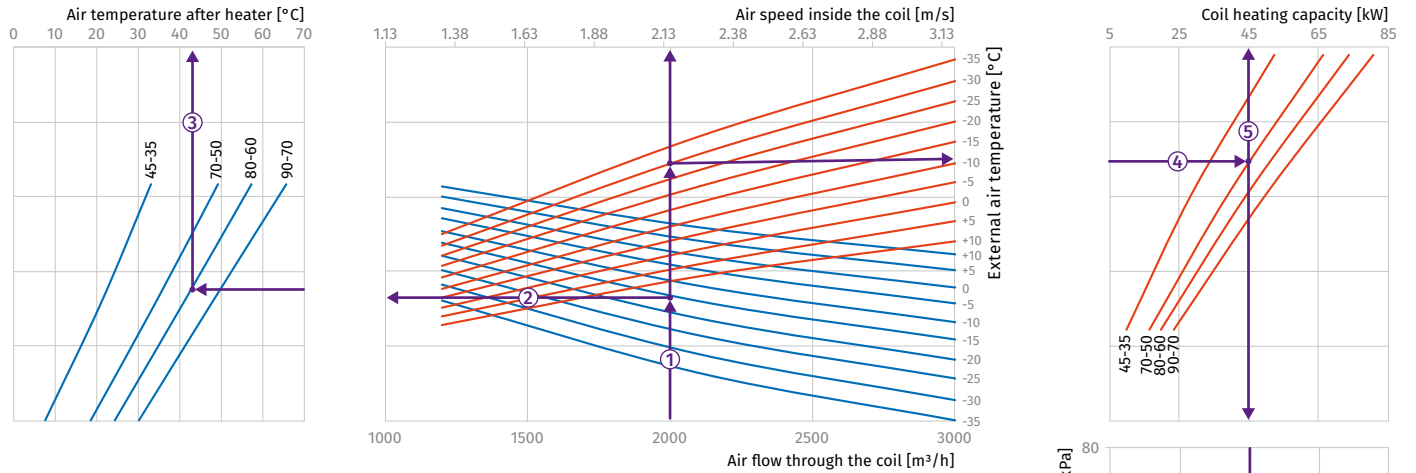

**How to use water heater diagrams**

- Air Speed. Starting from 2000 m³/h on the air flow scale draw a vertical line ① till the air speed axis which makes about 2.2 m/s.
- Supply air temperature. Prolong the line ① up to the point where it crosses the outside air temperature (blue curve), e.g. -15 °C; then draw a horizontal line ② from this point to the left till crossing water in/out temperature curve (80/60 °C). From this point draw a vertical line ③ to the supply air temperature axis on top of the graphic (+43 °C).

- Heating coil capacity. Prolong the line ① up to the point where it crosses the outside air temperature -15 °C (red curve) and draw a horizontal line ④ from this point to the right until it crosses water in/out temperature curve (70/50 °C), from here draw a vertical line ⑤ up to the scale representing the heating coil capacity (45 kW).
- Water flow. Prolong the line ⑤ down to water flow axis at the bottom of the graphic ⑥ (2650 kg/h).
- Water pressure drop. Draw the line ⑦ from the point where line ⑥ crosses the black curve to the pressure drop axis. (24 kPa).

**BLAUBOX EC MW 4000 S31**

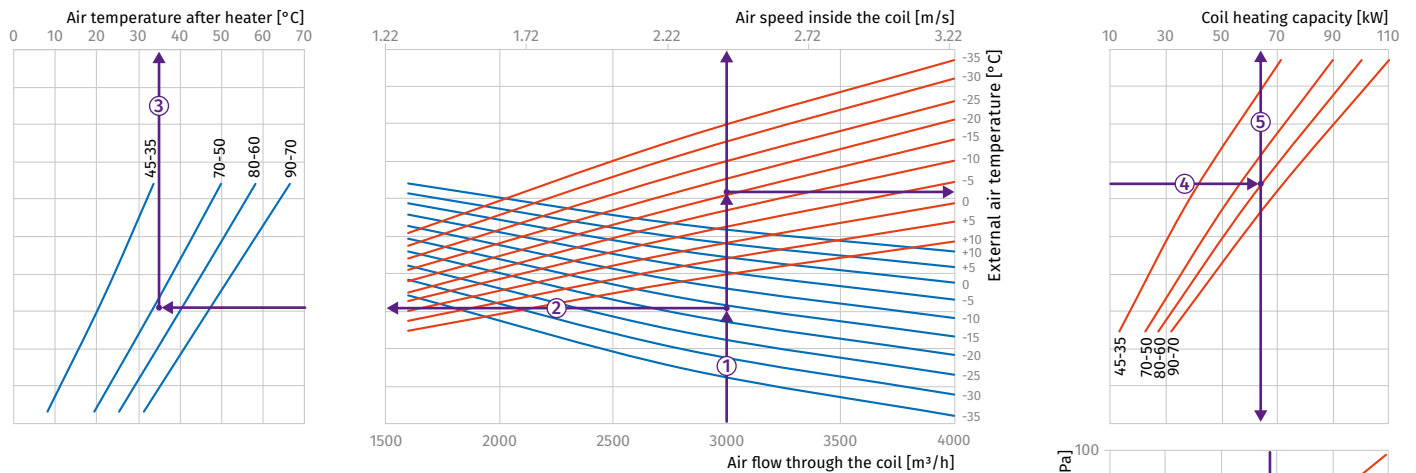







**How to use water heater diagrams**

- Air Speed. Starting from 3000 m³/h on the air flow scale draw a vertical line ① till the air speed axis which makes about 2.5 m/s.
- Supply air temperature. Prolong the line ① up to the point where it crosses the outside air temperature (blue curve), e.g. -20 °C; then draw a horizontal line ② from this point to the left till crossing water in/out temperature curve (70/50 °C). From this point draw a vertical line ③ to the supply air temperature axis on top of the graphic (+35 °C).

- Heating coil capacity. Prolong the line ① up to the point where it crosses the outside air temperature -20 °C (red curve) and draw a horizontal line ④ from this point to the right until it crosses water in/out temperature curve (80/60 °C), from here draw a vertical line ⑤ up to the scale representing the heating coil capacity (65 kW).
- Water flow. Prolong the line ⑤ down to water flow axis at the bottom of the graphic ⑥ (4100 kg/h).
- Water pressure drop. Draw the line ⑦ from the point where line ⑥ crosses the black curve to the pressure drop axis. (45 kPa).

## Accessories

		Blaubox EC MW 700	Blaubox EC MW 1000	Blaubox EC MW 1500	Blaubox EC MW 2000	Blaubox EC MW 3000	Blaubox EC MW 4000
<b>Panel filter G4</b>		FP 384x287x48 Coarse 90% / G4	FP 536x316x48 Coarse 90% / G4	FP 636x376x48 Coarse 90% / G4	FP 636x376x48 Coarse 90% / G4	FP 734x435x80 Coarse 90% / G4	FP 874x485x80 Coarse 90% / G4
<b>Panel filter F7</b>		FP 384x287x48 ePM1 70% / F7	FP 536x316x48 ePM1 70% / F7	FP 636x376x48 ePM1 70% / F7	FP 636x376x48 ePM1 70% / F7	FP 384x287x48 ePM1 70% / F7	FP 874x485x80 ePM1 70% / F7
<b>Flexible anti-vibration connector</b>		EVA 250	EVA 40x20	EVA 50x25	EVA 50x30	EVA 60x30	EVA 70x40
<b>Silencer</b>		SD 250	SD 40x20	SD 50x25	SD 50x30	SD 60x30	SD 70x40
<b>Air damper</b>		VKA 250	SL 40x20	SL 50x25	SL 50x30	SL 60x30	SL 70x40
<b>Air damper electric actuator</b>		TF230 / TF24	TF230 / TF24	TF230 / TF24	TF230 / TF24	TF230 / TF24	TF230 / TF24