

AXIS-FP

Axial smoke extraction fans

Use

- The fans are used for extraction of smoke in case of fire and removal of hot air outside. The fans are also used for general ventilation systems.
- The fans are rated for permanent operation at ambient air temperatures from -60 °C up to +50 °C (depends on climatic category, see the Designation key). The fans are able to operate 2 hours at the temperatures +300 °C and +400 °C.
- The fans with a fire resistance class of 200 °C/2 hours can be produced on request. The characteristics of the 200 °C/2 hours fans are completely identical to 300 °C/2 hours fans.



Air flow:
up to 114 000 m³/h



Fire resistance rating:
300 °C/2 hours
400 °C/2 hours

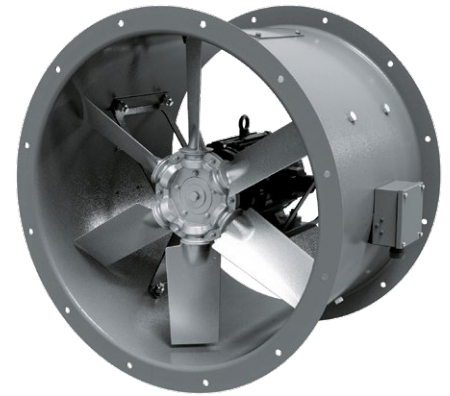

Design

- The fan consists of a casing, an impeller and a motor. The metal casing with rolled flanges helps achieve outstanding rigidity and minimum clearances between the casing and the blades. There is an inspection hatch in the casing for easy maintenance.
- All the casing components are powder coated for improved protection against the environmental effects.
- The weight of the fans may differ from the one stated in the catalogue and depends on the components used (motor, terminal box, etc.).

Motor

- The fans are equipped with three-phase (400 V/50 Hz) motors. Motor ingress protection rating is IP55. Depending on the model, the fans have single- or double-speed modifications.
- The single-speed models are equipped with 2-, 4- or 6-pole motors.
- The double-speed models are equipped with 2/4-, 4/6- or 4/8-pole motors.

Impeller

- Depending on the size and the required air capacity the fans are equipped with impellers with 4, 5, 6, 7, 8, 9 or 12 blades angled from 20° to 50° to ensure precise matching of fans with the operating point.
- The specially designed impeller blades ensure high efficiency of the fan while keeping noise well under control.
- The impellers are dynamically balanced. Low weight and low moment of the impeller inertia help reduce the fan start-up time.
- The fan blades are made of cast aluminium.

Mounting

- The fans can be mounted on any flat surface or directly into a ventilation duct. The units are suitable for both horizontal and vertical configurations.
- Installation in the air duct requires flanges to attach the fan to the ductwork.
- To attach the fan to the floor, the wall or the ceiling use the O-AF carriers (not included as standard, should be purchased separately).
- The fans are suitable for installation on rooftops.

Designation key

Casing
Motor
Impeller
Modification
AXIS-FP 630 K - 2 D / 5.5 - 8 / 35 / AL - U 1 - 300/2

Axis-FP:
Axial smoke extraction fan

Standard size (duct diameter) [mm]

Modification:
 _: standard casing
 K: shortened casing

Number of motor poles

Motor phase:
 E: single-phase
 D: three-phase

Motor power [kW]

Number of impeller blades [items]

Blade setting angle [°]

Blade material:
 AL: aluminium

Climatic category:
 U: moderate climate (-40 ... +40 °C)
 HL: cold climate (-60 ... +40 °C)
 UHL: moderate and cold climate (-60 ... +40 °C)
 T: tropical climate (-10 ... +50 °C)
 M: maritime moderately cold climate (-40 ... +40 °C)
 O: general climatic modification (except maritime climate) (-60 ... +50 °C)
 OM: general maritime climatic modification (-40 ... +40 °C)
 V: universal climatic modification (-60 ... +50 °C)

Placement category:
 1: outdoors
 2: under a shed or indoors with the same conditions as outdoors except solar radiation and precipitation
 3: in closed rooms without artificial climate control
 4: in closed rooms with artificial climate control (ventilation, heating)
 5: in rooms with high levels of humidity, without artificial climate control

Fire resistance rating:
 300/2: 300 °C, 2 hours
 400/2: 400 °C, 2 hours

Overall dimensions [mm]

Model	Ø D	Ø D1	Ø D2	Ø d	n	W
Axis-FP 400...	400	450	490	8	12	525
Axis-FP 450...	450	500	540	8	12	580
Axis-FP 500...	500	560	600	12	12	620
Axis-FP 560...	560	620	660	12	12	680
Axis-FP 630...	630	690	730	12	12	750
Axis-FP 700...	710	770	810	12	16	845
Axis-FP 800...	800	860	900	12	16	925
Axis-FP 900...	900	970	1015	15	16	1025
Axis-FP 1000...	1000	1070	1115	15	16	1140
Axis-FP 1120...	1120	1190	1270	15	20	1280
Axis-FP 1250...	1250	1320	1400	15	20	1450

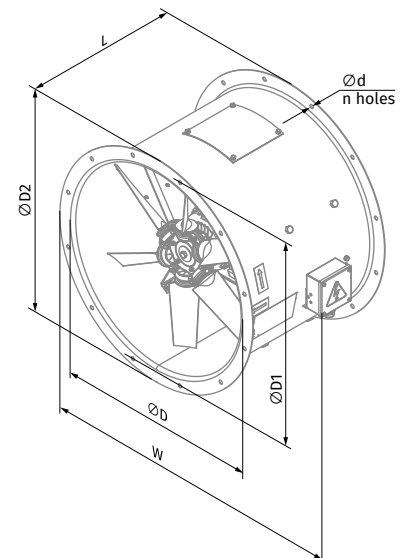

AXIAL SMOKE EXTRACTION FANS

Technical data AXIS-FP...300/2

AXIS-FP 400...300/2

Size	Number of poles	Voltage [V/50 Hz]	Fan model	Installed motor power Ny [kW]	RPM [min ⁻¹]	Number of blades	Blade setting angle [°]	Weight [kg]	Length L [mm]	Curve number on graph
Axis-FP 400-2D...300/2										
400	2	3~400	Axis-FP 400-2D/0.55-6/25/AL	0.55	2880	6	25	23	400	①
			Axis-FP 400-2D/0.75-6/30/AL	0.75	2880	6	30	24.6	400	②
			Axis-FP 400-2D/1.1-6/35/AL	1.1	2880	6	35	28.6	400	③
			Axis-FP 400-2D/1.5-6/40/AL	1.5	2880	6	40	30.1	400	④
			Axis-FP 400-2D/1.5-6/45/AL	1.5	2880	6	45	30.1	400	⑤
			Axis-FP 400-2D/2.2-8/45/AL	2.2	2880	8	45	32.6	400	⑥
Axis-FP 400-4D...300/2										
400	4	3~400	Axis-FP 400-4D/0.55-6/30/AL	0.55	1440	6	30	24.5	400	①
			Axis-FP 400-4D/0.55-6/35/AL	0.55	1440	6	35	24.5	400	②
			Axis-FP 400-4D/0.55-6/40/AL	0.55	1440	6	40	24.5	400	③
			Axis-FP 400-4D/0.55-6/45/AL	0.55	1440	6	45	24.5	400	④
			Axis-FP 400-4D/0.55-8/45/AL	0.55	1440	8	45	25.0	400	⑤

Standard size: 400
Number of poles: 2
Fire resistance rating: 300/2

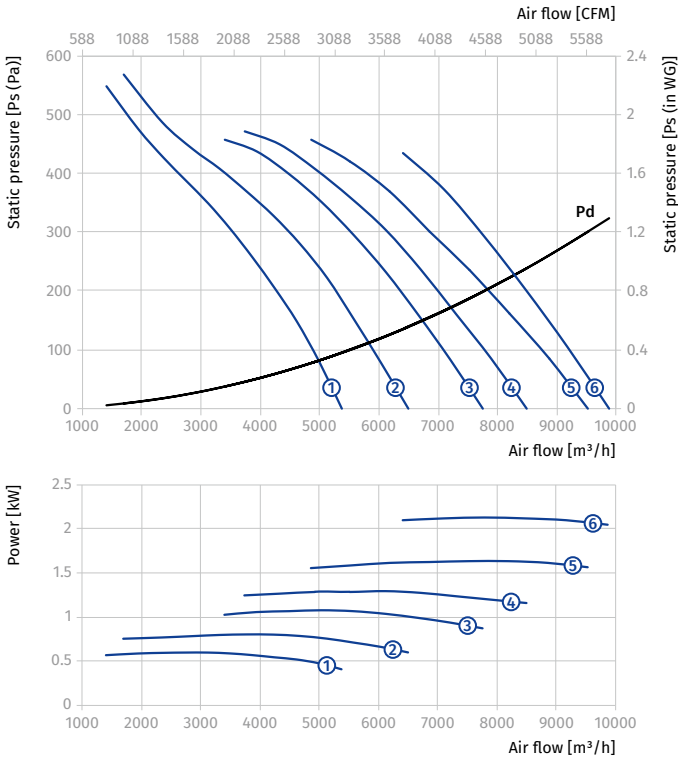

Standard size: 400
Number of poles: 4
Fire resistance rating: 300/2

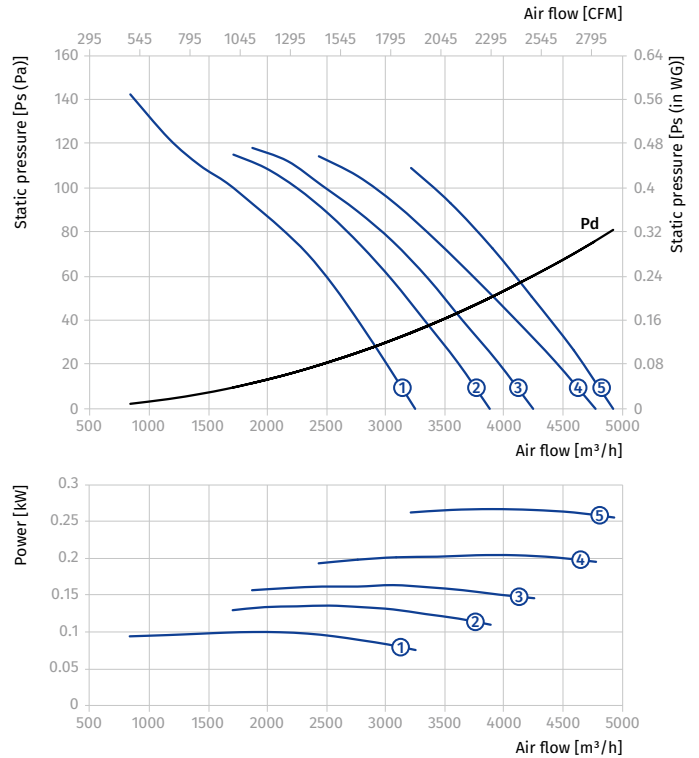

AXIS-FP 400...300/2

Size	Number of poles	Voltage [V/50 Hz]	Fan model	Installed motor power N_y [kW]	RPM [min^{-1}]	Number of blades	Blade setting angle [°]	Weight [kg]	Length L [mm]	Curve number on graph
Axis-FP 400-2/4D...300/2										
400	2/4	3~400	Axis-FP 400-2/4D/0.8/0.2-6/30/AL	0.8/0.2	2880/1440	6	30	29.1	400	①
			Axis-FP 400-2/4D/1.1/0.25-6/35/AL	1.1/0.25	2880/1440	6	35	30.1	400	②
			Axis-FP 400-2/4D/1.5/0.37-6/40/AL	1.5/0.37	2880/1440	6	40	35.8	400	③
			Axis-FP 400-2/4D/1.5/0.37-6/45/AL	1.5/0.37	2880/1440	6	45	35.8	400	④
			Axis-FP 400-2/4D/2.2/0.5-8/45/AL	2.2/0.5	2880/1440	8	45	38	400	⑤

Standard size: 400
 Number of poles: 2
 Fire resistance rating: 300/2

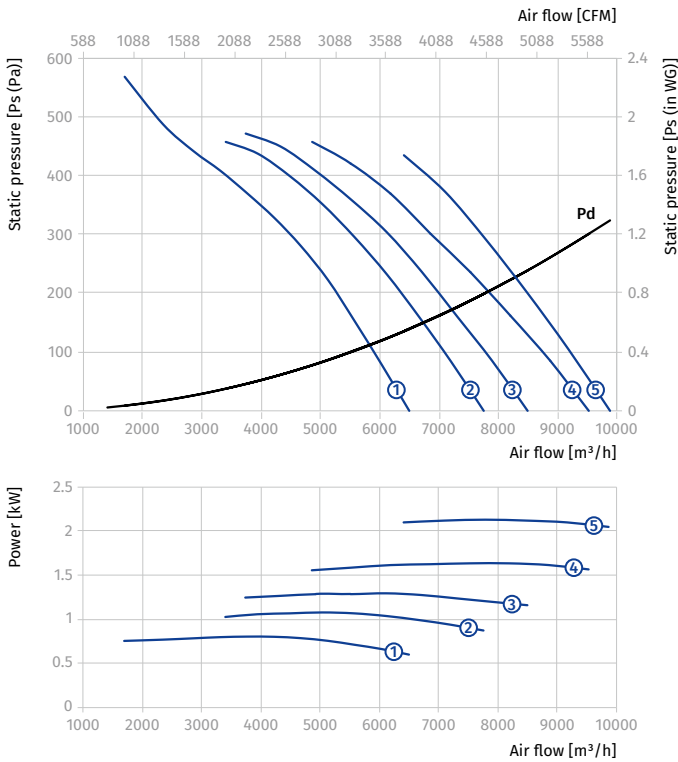

Standard size: 400
 Number of poles: 4
 Fire resistance rating: 300/2

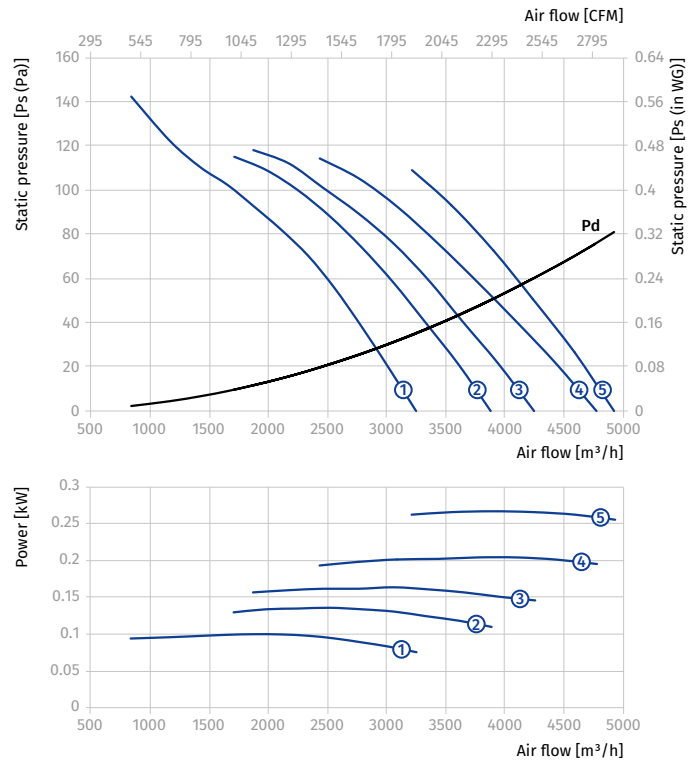

AXIS-FP 450...300/2

Size	Number of poles	Voltage [V/50 Hz]	Fan model	Installed motor power Ny [kW]	RPM [min ⁻¹]	Number of blades	Blade setting angle [°]	Weight [kg]	Length L [mm]	Curve number on graph
Axis-FP 450-2D...300/2										
450	2	3~400	Axis-FP 450-2D/0.75-6/25/AL	0.75	2880	6	25	26.1	400	①
			Axis-FP 450-2D/1.1-6/30/AL	1.1	2880	6	30	30.1	400	②
			Axis-FP 450-2D/1.5-6/35/AL	1.5	2880	6	35	31.6	400	③
			Axis-FP 450-2D/2.2-6/40/AL	2.2	2880	6	40	34	400	④
			Axis-FP 450-2D/3-8/40/AL	3	2880	8	40	41	400	⑤
			Axis-FP 450-2D/4-8/45/AL	4	2880	8	45	52.8	500	⑥
Axis-FP 450-4D...300/2										
450	4	3~400	Axis-FP 450-4D/0.55-6/25/AL	0.55	1440	6	25	24.6	400	①
			Axis-FP 450-4D/0.55-6/30/AL	0.55	1440	6	30	24.6	400	②
			Axis-FP 450-4D/0.55-6/35/AL	0.55	1440	6	35	24.6	400	③
			Axis-FP 450-4D/0.55-6/40/AL	0.55	1440	6	40	24.6	400	④
			Axis-FP 450-4D/0.55-8/40/AL	0.55	1440	8	40	24.6	400	⑤
			Axis-FP 450-4D/0.55-8/45/AL	0.55	1440	8	45	25	400	⑥

Standard size: 450
Number of poles: 2
Fire resistance rating: 300/2

Standard size: 450
Number of poles: 4
Fire resistance rating: 300/2

AXIAL SMOKE EXTRACTION FANS

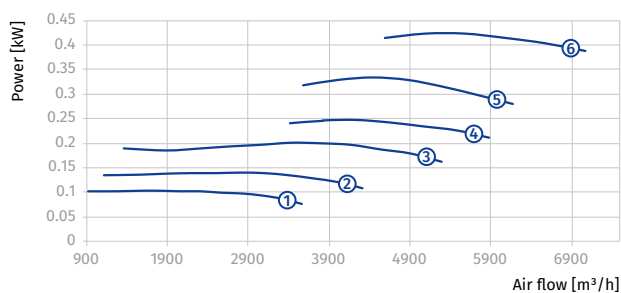
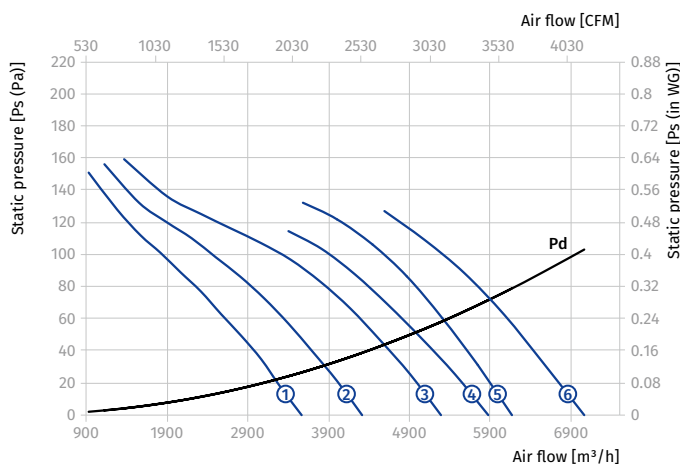
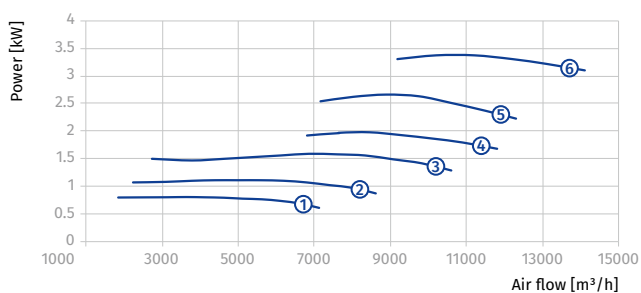
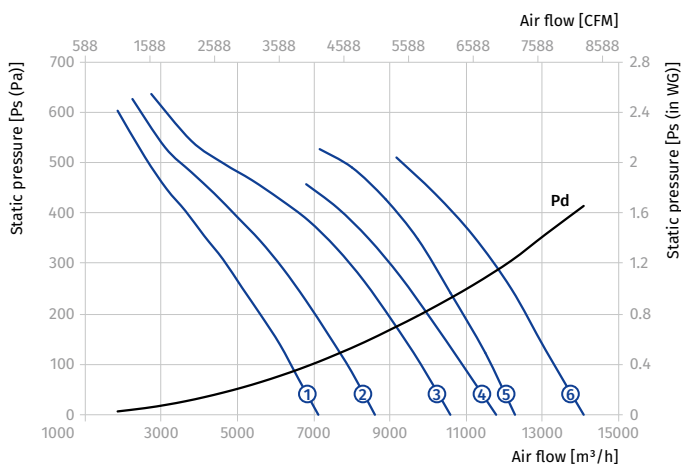

AXIS-FP 450...300/2

Size	Number of poles	Voltage [V/50 Hz]	Fan model	Installed motor power N_y [kW]	RPM [min^{-1}]	Number of blades	Blade setting angle [°]	Weight [kg]	Length L [mm]	Curve number on graph
Axis-FP 450-2/4D...300/2										
450	2/4	3~400	Axis-FP 450-2/4D/0.8/0.2-6/25/AL	0.8/0.2	2880/1440	6	25	30.6	400	①
			Axis-FP 450-2/4D/1.1/0.25-6/30/AL	1.1/0.25	2880/1440	6	30	31.6	400	②
			Axis-FP 450-2/4D/1.5/0.37-6/35/AL	1.5/0.37	2880/1440	6	35	37.3	400	③
			Axis-FP 450-2/4D/2.2/0.5-6/40/AL	2.2/0.5	2880/1440	6	40	39.3	400	④
			Axis-FP 450-2/4D/3.1/0.8-8/40/AL	3.1/0.8	2880/1440	8	40	51.9	500	⑤
			Axis-FP 450-2/4D/4.4/1.1-8/45/AL	4.4/1.1	2880/1440	8	45	63.8	500	⑥

Standard size: 450
 Number of poles: 2
 Fire resistance rating: 300/2

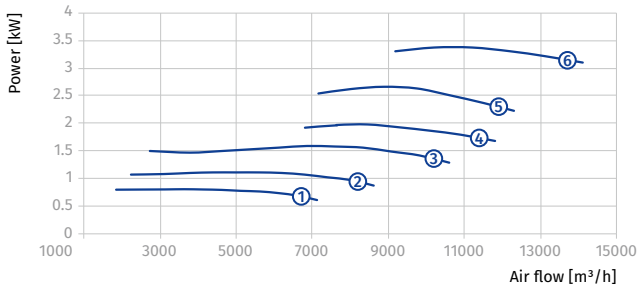
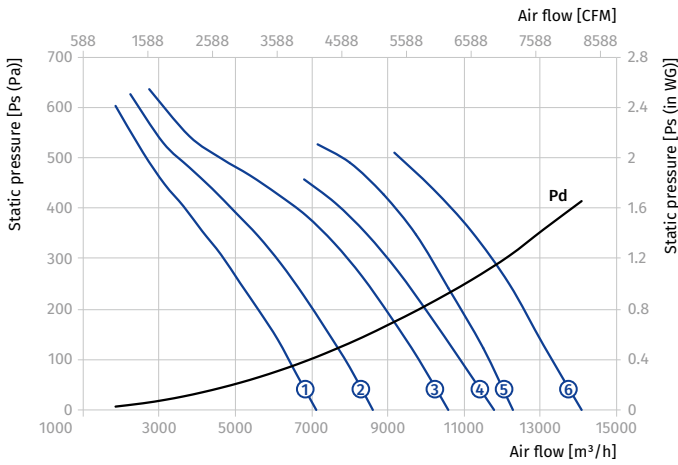

Standard size: 450
 Number of poles: 4
 Fire resistance rating: 300/2

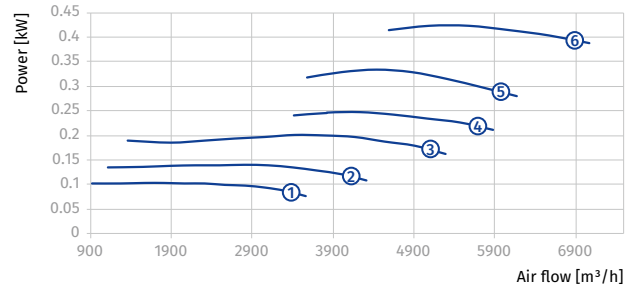
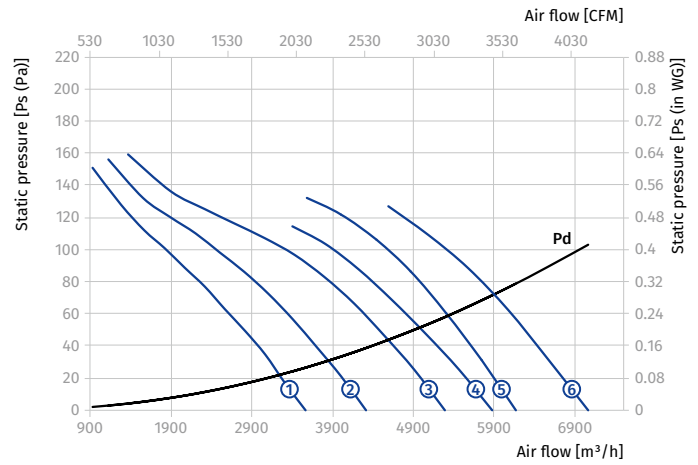

AXIS-FP 500...300/2

Size	Number of poles	Voltage [V/50 Hz]	Fan model	Installed motor power Ny [kW]	RPM [min ⁻¹]	Number of blades	Blade setting angle [°]	Weight [kg]	Length L [mm]	Curve number on graph
Axis-FP 500-2D...300/2										
500	2	3~400	Axis-FP 500-2D/1.1-6/25/AL	1.1	2880	6	25	32.0	400	①
			Axis-FP 500-2D/1.5-6/30/AL	1.5	2880	6	30	33.5	400	②
			Axis-FP 500-2D/2.2-6/35/AL	2.2	2880	6	35	36.0	400	③
			Axis-FP 500-2D/3-8/35/AL	3	2880	8	35	43.0	400	④
			Axis-FP 500-2D/4-8/40/AL	4	2880	8	40	55.0	500	⑤
			Axis-FP 500-2D/5.5-8/45/AL	5.5	2880	8	45	63	500	⑥
Axis-FP 500-4D...300/2										
500	4	3~400	Axis-FP 500-4D/0.55-6/25/AL	0.55	1440	6	25	28.0	400	①
			Axis-FP 500-4D/0.55-6/30/AL	0.55	1440	6	30	28.0	400	②
			Axis-FP 500-4D/0.55-6/35/AL	0.55	1440	6	35	28.0	400	③
			Axis-FP 500-4D/0.55-6/40/AL	0.55	1440	6	40	28.0	400	④
			Axis-FP 500-4D/0.55-6/45/AL	0.55	1440	6	45	28.0	400	⑤
			Axis-FP 500-4D/0.75-8/45/AL	0.75	1440	8	45	29.5	400	⑥

Standard size: 500
Number of poles: 2
Fire resistance rating: 300/2

Standard size: 500
Number of poles: 4
Fire resistance rating: 300/2

AXIAL SMOKE EXTRACTION FANS

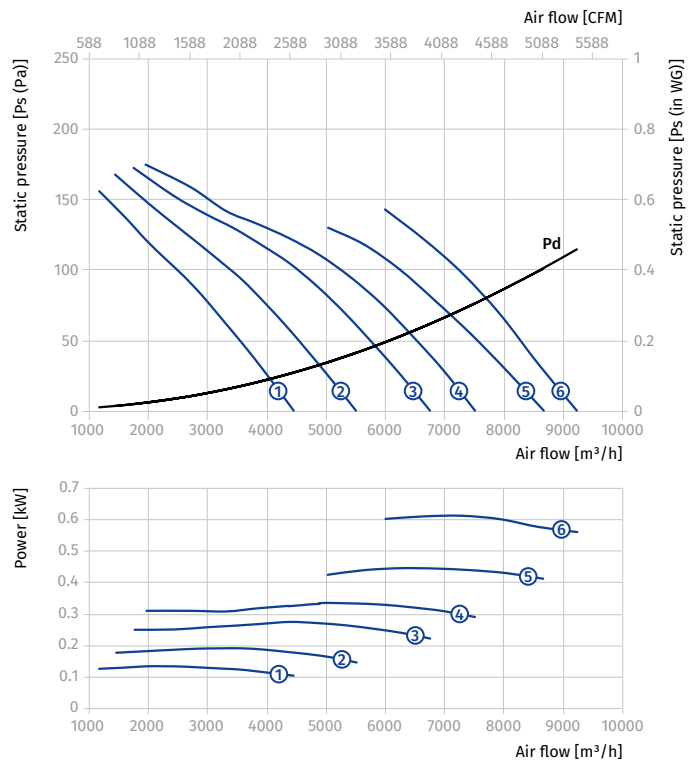
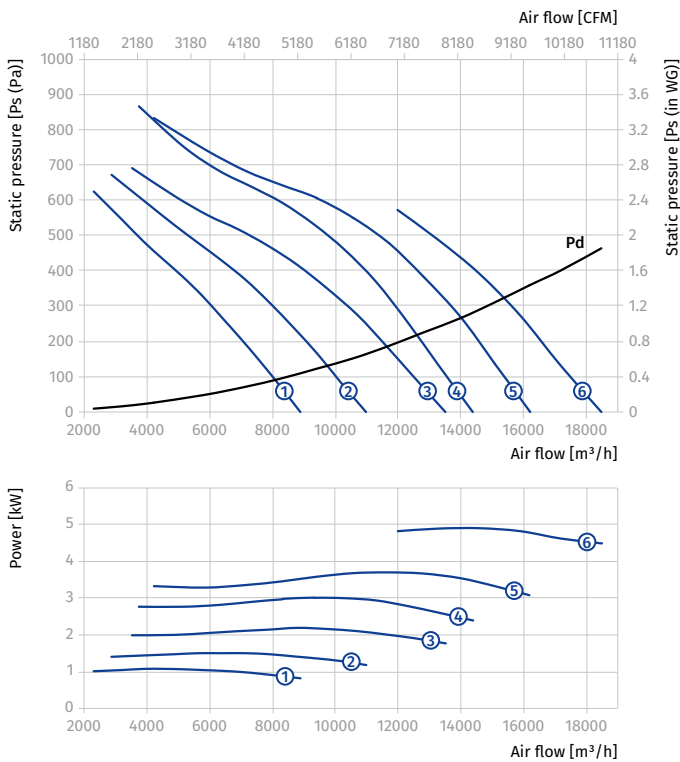

AXIS-FP 500...300/2

Size	Number of poles	Voltage [V/50 Hz]	Fan model	Installed motor power N_y [kW]	RPM [min^{-1}]	Number of blades	Blade setting angle [°]	Weight [kg]	Length L [mm]	Curve number on graph
Axis-FP 500-2/4D...300/2										
500	2/4	3~400	Axis-FP 500-2/4D/1.1/0.25-6/25/AL	1.1/0.25	2880/1440	6	25	33.5	400	①
			Axis-FP 500-2/4D/1.5/0.37-6/30/AL	1.5/0.37	2880/1440	6	30	39	400	②
			Axis-FP 500-2/4D/2.2/0.5-6/35/AL	2.2/0.5	2880/1440	6	35	41	400	③
			Axis-FP 500-2/4D/3.1/0.8-8/35/AL	3.1/0.8	2880/1440	8	35	54	500	④
			Axis-FP 500-2/4D/4.4/1.1-8/40/AL	4.4/1.1	2880/1440	8	40	66	500	⑤
			Axis-FP 500-2/4D/6/1.5-8/45/AL	6/1.5	2880/1440	8	45	85	550	⑥

Standard size: 500
 Number of poles: 2
 Fire resistance rating: 300/2

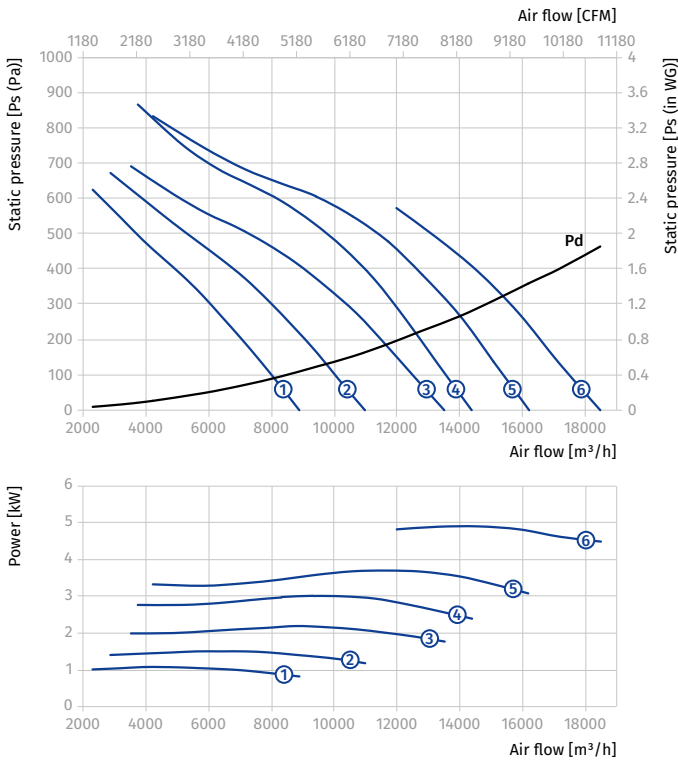

Standard size: 500
 Number of poles: 4
 Fire resistance rating: 300/2

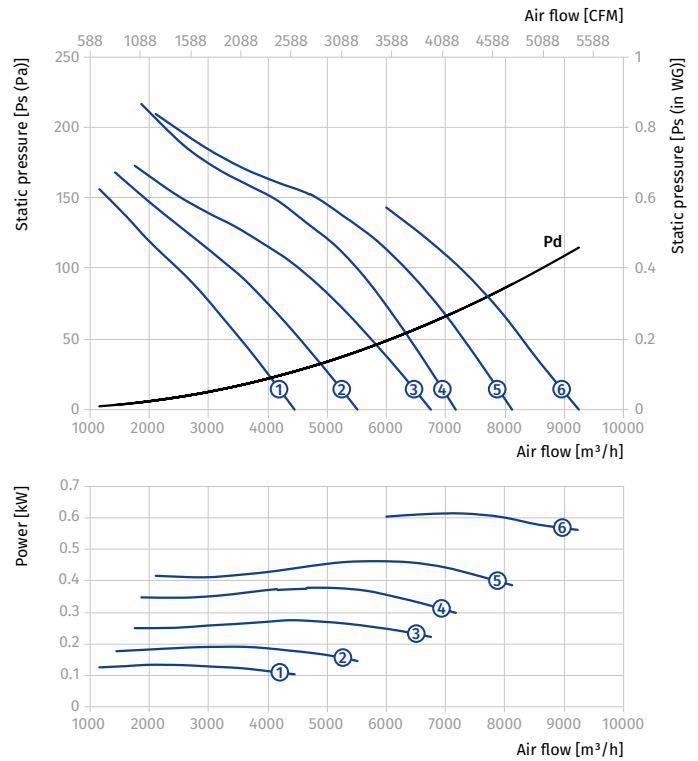

AXIAL SMOKE EXTRACTION FANS

AXIS-FP 560...300/2

Size	Number of poles	Voltage [V/50 Hz]	Fan model	Installed motor power Ny [kW]	RPM [min ⁻¹]	Number of blades	Blade setting angle [°]	Weight [kg]	Length L [mm]	Curve number on graph
Axis-FP 560-2D...300/2										
560	2	3~400	Axis-FP 560-2D/1.1-6/25/AL	1.1	2880	6	25	34	400	①
			Axis-FP 560-2D/1.5-6/30/AL	1.5	2880	6	30	35.5	400	②
			Axis-FP 560-2D/2.2-8/30/AL	2.2	2880	8	30	38	400	③
			Axis-FP 560-2D/4-8/35/AL	4	2880	8	35	57.5	500	④
			Axis-FP 560-2D/5.5-8/40/AL	5.5	2880	8	40	65.5	500	⑤
			Axis-FP 560-2D/7.5-8/45/AL	7.5	2880	8	45	67.5	500	⑥
Axis-FP 560-4D...300/2										
560	4	3~400	Axis-FP 560-4D/0.55-6/25/AL	0.55	1440	6	25	30	400	①
			Axis-FP 560-4D/0.55-6/30/AL	0.55	1440	6	30	30	400	②
			Axis-FP 560-4D/0.55-6/35/AL	0.55	1440	6	35	30	400	③
			Axis-FP 560-4D/0.55-6/40/AL	0.55	1440	6	40	30	400	④
			Axis-FP 560-4D/0.55-6/45/AL	0.55	1440	6	45	30	400	⑤
			Axis-FP 560-4D/0.75-8/45/AL	0.75	1440	8	45	31.5	400	⑥

Standard size: 560
Number of poles: 2
Fire resistance rating: 300/2

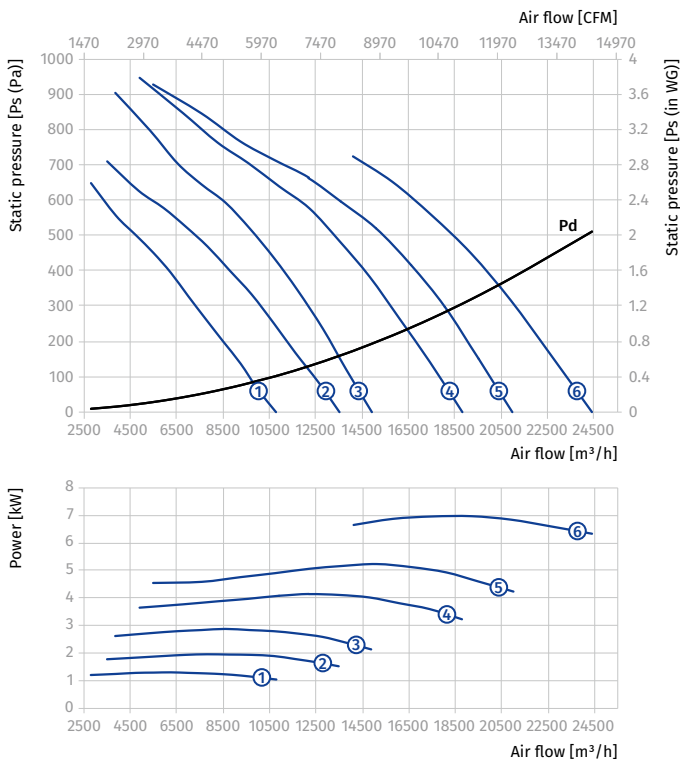

Standard size: 560
Number of poles: 4
Fire resistance rating: 300/2

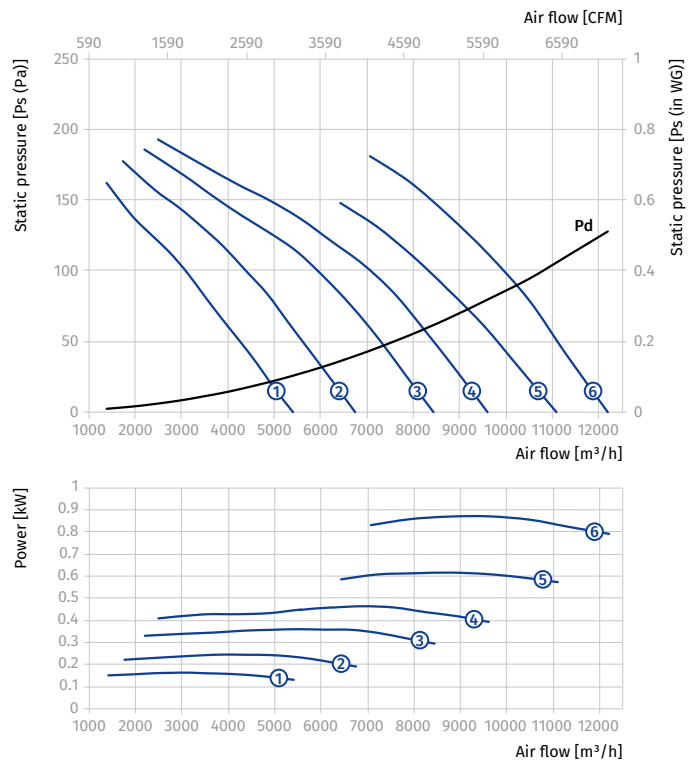

AXIS-FP 560...300/2

Size	Number of poles	Voltage [V/50 Hz]	Fan model	Installed motor power N_y [kW]	RPM [min^{-1}]	Number of blades	Blade setting angle [°]	Weight [kg]	Length L [mm]	Curve number on graph
Axis-FP 560-2/4D...300/2										
560	2/4	3~400	Axis-FP 560-2/4D/1.1/0.25-6/25/AL	1.1/0.25	2880/1440	6	25	35.5	400	①
			Axis-FP 560-2/4D/1.5/0.37-6/30/AL	1.5/0.37	2880/1440	6	30	41	400	②
			Axis-FP 560-2/4D/2.2/0.5-8/30/AL	2.2/0.5	2880/1440	8	30	43.5	400	③
			Axis-FP 560-2/4D/4.4/1.1-8/35/AL	4.4/1.1	2880/1440	8	35	68.5	500	④
			Axis-FP 560-2/4D/6/1.5-8/40/AL	6/1.5	2880/1440	8	40	96.5	550	⑤
			Axis-FP 560-2/4D/8/2-8/45/AL	8/2	2880/1440	8	45	105.5	550	⑥

Standard size: 560
 Number of poles: 2
 Fire resistance rating: 300/2

Standard size: 560
 Number of poles: 4
 Fire resistance rating: 300/2

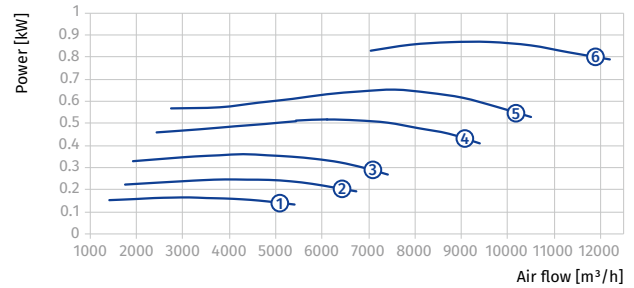
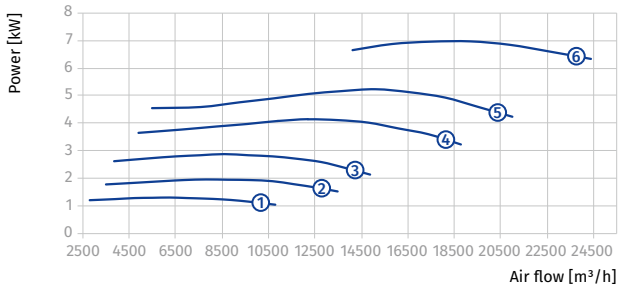
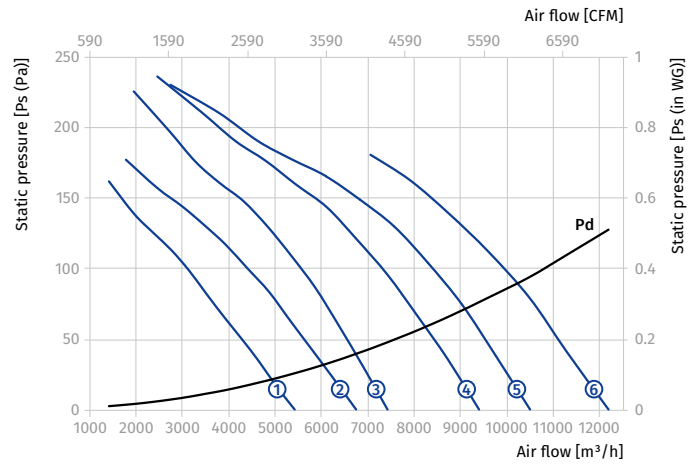
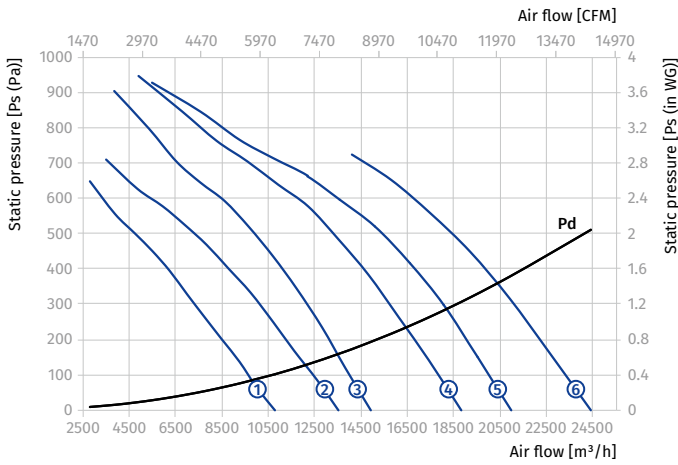

AXIS-FP 630...300/2

Size	Number of poles	Voltage [V/50 Hz]	Fan model	Installed motor power Ny [kW]	RPM [min ⁻¹]	Number of blades	Blade setting angle [°]	Weight [kg]	Length L [mm]	Curve number on graph
Axis-FP 630-2D...300/2										
630	2	3~400	Axis-FP 630-2D/2.2-6/25/AL	2.2	2880	6	25	41.5	400	①
			Axis-FP 630-2D/3-6/30/AL	3	2880	6	30	48	400	②
			Axis-FP 630-2D/4-7/32.5/AL	4	2880	7	32.5	61.5	500	③
			Axis-FP 630-2D/5.5-7/35/AL	5.5	2880	7	35	70	500	④
			Axis-FP 630-2D/5.5-7/37.5/AL	5.5	2880	7	37.5	70	500	⑤
			Axis-FP 630-2D/7.5-7/41.5/AL	7.5	2880	7	41.5	71.5	500	⑥
			Axis-FP 630-2D/11-8/41.5/AL	11	2880	8	41.5	119.5	550	⑦
			Axis-FP 630-2D/15-8/46.5/AL	15	2880	8	46.5	167	700	⑧
			Axis-FP 630-2D/15-9/48.5/AL	15	2880	9	48.5	166	700	⑨
Axis-FP 630-4D...300/2										
630	4	3~400	Axis-FP 630-4D/0.55-8/25/AL	0.55	1440	8	25	31.5	400	①
			Axis-FP 630-4D/0.55-8/30/AL	0.55	1440	8	30	31.5	400	②
			Axis-FP 630-4D/0.75-8/35/AL	0.75	1440	8	35	32.5	400	③
			Axis-FP 630-4D/1.1-8/40/AL	1.1	1440	8	40	36.5	400	④
			Axis-FP 630-4D/1.1-6/32.5/AL	1.1	1440	6	32.5	38.5	400	⑤
			Axis-FP 630-4D/1.5-6/37.5/AL	1.5	1440	6	37.5	42.5	400	⑥
			Axis-FP 630-4D/2.2-6/45/AL	2.2	1440	6	45	48.5	400	⑦

Standard size: 630
Number of poles: 2
Fire resistance rating: 300/2

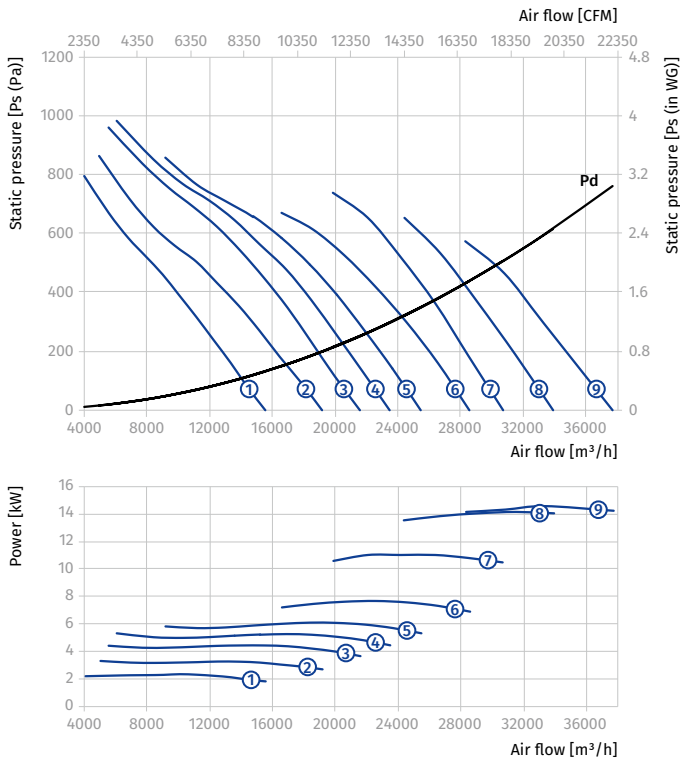

Standard size: 630
Number of poles: 4
Fire resistance rating: 300/2

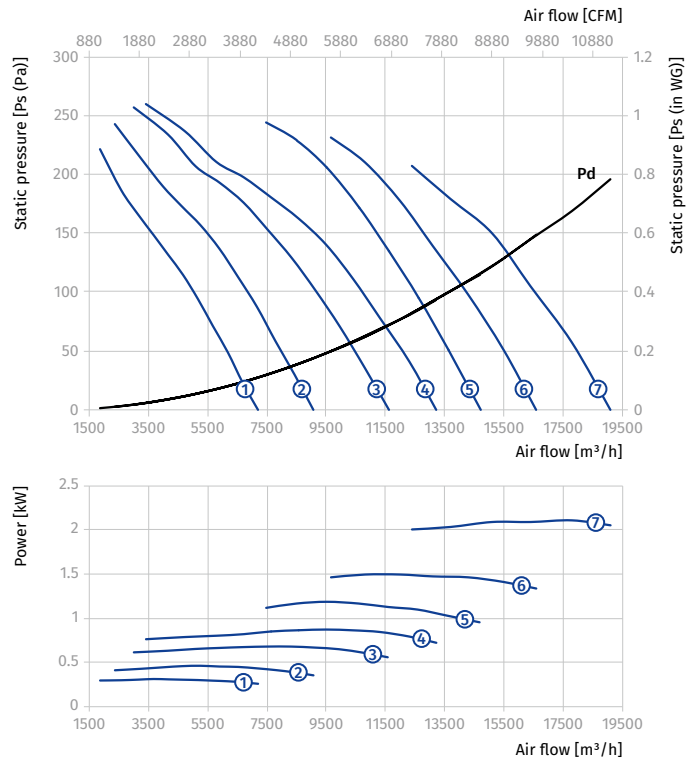

AXIS-FP 630...300/2

Size	Number of poles	Voltage [V/50 Hz]	Fan model	Installed motor power Ny [kW]	RPM [min ⁻¹]	Number of blades	Blade setting angle [°]	Weight [kg]	Length L [mm]	Curve number on graph
Axis-FP 630-2/4D...300/2										
630	2/4	3~400	Axis-FP 630-2/4D/2.2/0.5-6/25/AL	2.2/0.5	2880/1440	6	25	46.5	400	①
			Axis-FP 630-2/4D/3.1/0.8-6/30/AL	3.1/0.8	2880/1440	6	30	60	500	②
			Axis-FP 630-2/4D/4.4/1.1-7/32.5/AL	4.4/1.1	2880/1440	7	32.5	72.5	500	③
			Axis-FP 630-2/4D/6/1.5-7/35/AL	6/1.5	2880/1440	7	35	102	550	④
			Axis-FP 630-2/4D/6/1.5-7/37.5/AL	6/1.5	2880/1440	7	37.5	102	550	⑤
			Axis-FP 630-2/4D/8/2-7/41.5/AL	8/2	2880/1440	7	41.5	111	550	⑥
			Axis-FP 630-2/4D/12/3-8/41.5/AL	12/3	2880/1440	8	41.5	177	700	⑦
			Axis-FP 630-2/4D/16/4-8/46.5/AL	16/4	2880/1440	8	46.5	194	700	⑧
			Axis-FP 630-2/4D/16/4-9/48.5/AL	16/4	2880/1440	9	48.5	195	700	⑨

Standard size: **630**
 Number of poles: **2**
 Fire resistance rating: **300/2**

Standard size: **630**
 Number of poles: **4**
 Fire resistance rating: **300/2**

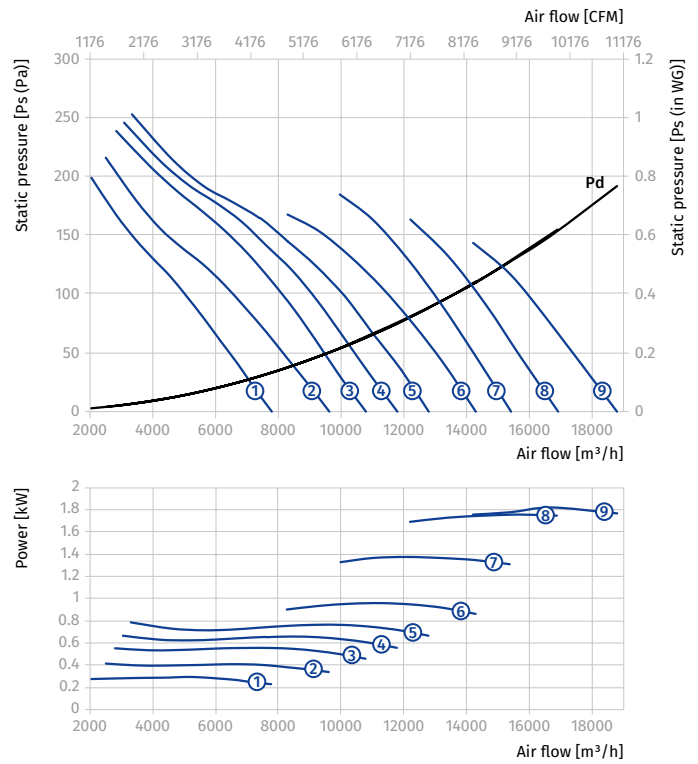
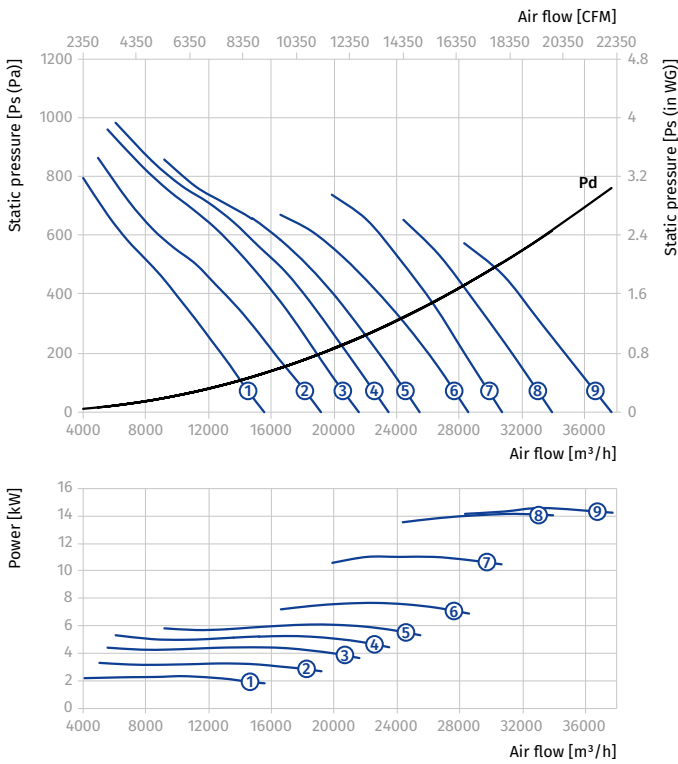

AXIS-FP 630...300/2

Size	Number of poles	Voltage [V/50 Hz]	Fan model	Installed motor power Ny [kW]	RPM [min ⁻¹]	Number of blades	Blade setting angle [°]	Weight [kg]	Length L [mm]	Curve number on graph
Axis-FP 630-4/6D...300/2										
630	4/6	3~400	Axis-FP 630-4/6D/0.55/0.2-8/25/AL	0.55/0.2	1440/960	8	25	34	400	①
			Axis-FP 630-4/6D/0.55/0.2-8/30/AL	0.55/0.2	1440/960	8	30	34	400	②
			Axis-FP 630-4/6D/0.75/0.25-8/35/AL	0.75/0.25	1440/960	8	35	34	400	③
			Axis-FP 630-4/6D/1.1/0.3-8/40/AL	1.1/0.3	1440/960	8	40	39.5	400	④
			Axis-FP 630-4/6D/1.1/0.3-6/32.5/AL	1.1/0.3	1440/960	6	32.5	42	400	⑤
			Axis-FP 630-4/6D/1.5/0.37-6/37.5/AL	1.5/0.37	1440/960	6	37.5	46	400	⑥
			Axis-FP 630-4/6D/2.2/0.7-6/45/AL	2.2/0.7	1440/960	6	45	57	500	⑦

Standard size: 630
Number of poles: 4
Fire resistance rating: 300/2

Standard size: 630
Number of poles: 6
Fire resistance rating: 300/2

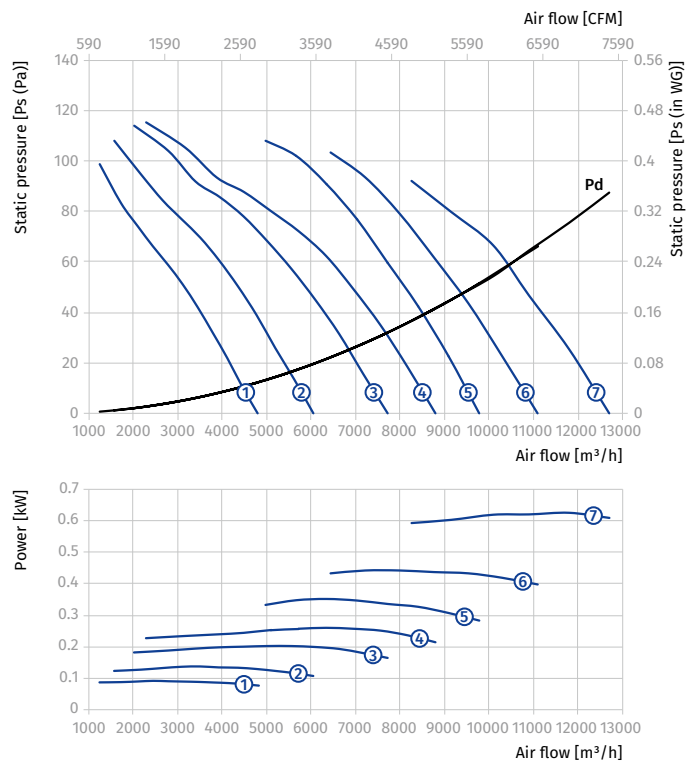
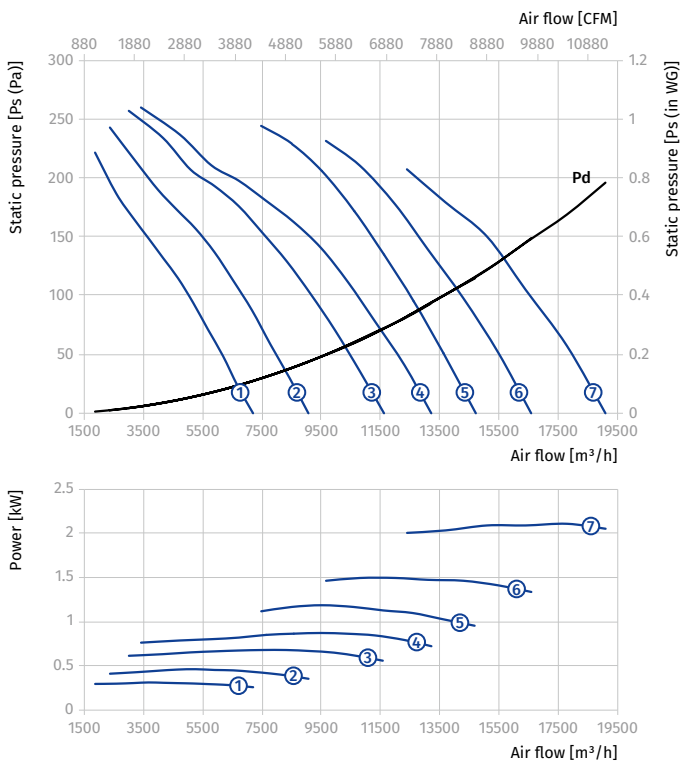

AXIS-FP 630...300/2

Size	Number of poles	Voltage [V/50 Hz]	Fan model	Installed motor power N_y [kW]	RPM [min ⁻¹]	Number of blades	Blade setting angle [°]	Weight [kg]	Length L [mm]	Curve number on graph
Axis-FP 630-4/8D...300/2										
630	4/8	3~400	Axis-FP 630-4/8D/0.6/0.15-8/25/AL	0.6/0.15	1440/720	8	25	38	400	①
			Axis-FP 630-4/8D/0.6/0.15-8/30/AL	0.6/0.15	1440/720	8	30	38	400	②
			Axis-FP 630-4/8D/0.8/0.2-8/35/AL	0.8/0.2	1440/720	8	35	38	400	③
			Axis-FP 630-4/8D/1.2/0.3-8/40/AL	1.2/0.3	1440/720	8	40	43.5	400	④
			Axis-FP 630-4/8D/1.2/0.3-6/32.5/AL	1.2/0.3	1440/720	6	32.5	46	400	⑤
			Axis-FP 630-4/8D/1.6/0.4-6/37.5/AL	1.6/0.4	1440/720	6	37.5	49	400	⑥
			Axis-FP 630-4/8D/2.2/0.55-6/45/AL	2.2/0.55	1440/720	6	45	60	500	⑦

Standard size: 630
 Number of poles: 4
 Fire resistance rating: 300/2

Standard size: 630
 Number of poles: 8
 Fire resistance rating: 300/2

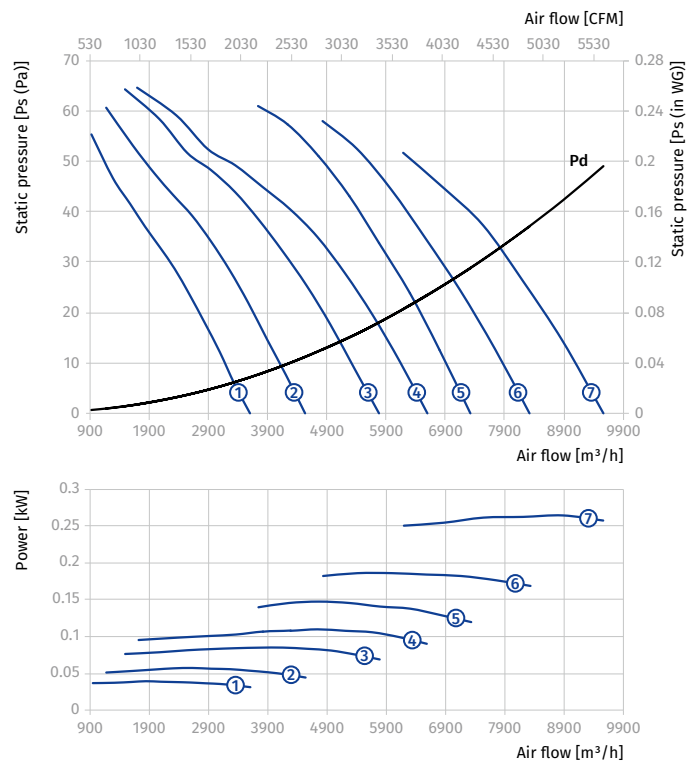
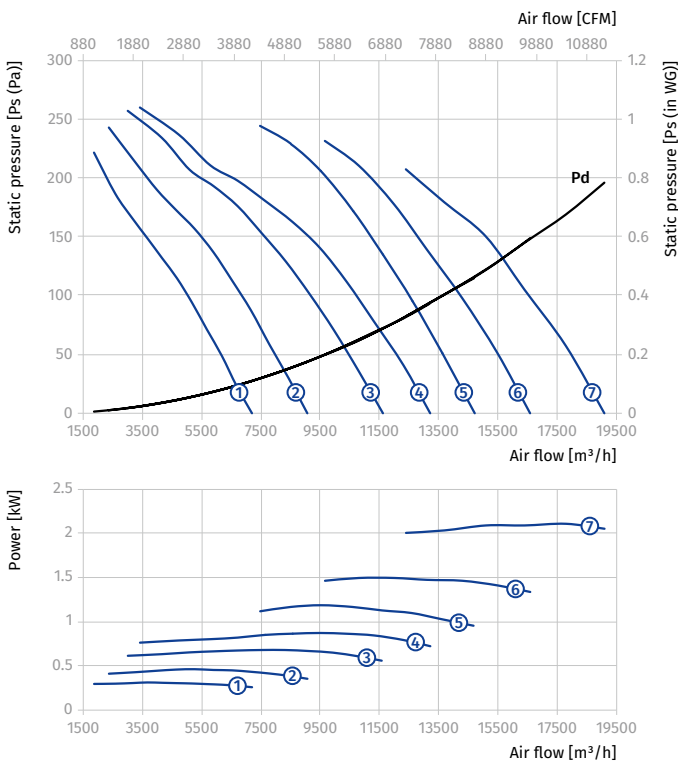

AXIS-FP 710...300/2

Size	Number of poles	Voltage [V/50 Hz]	Fan model	Installed motor power Ny [kW]	RPM [min ⁻¹]	Number of blades	Blade setting angle [°]	Weight [kg]	Length L [mm]	Curve number on graph
Axis-FP 710-4D...300/2										
710	4	3~400	Axis-FP 710-4D/0.75-6/20/AL	0.75	1440	6	20	47.5	400	①
			Axis-FP 710-4D/1.1-6/25/AL	1.1	1440	6	25	51.5	400	②
			Axis-FP 710-4D/1.5-6/30/AL	1.5	1440	6	30	55	400	③
			Axis-FP 710-4D/2.2-6/35/AL	2.2	1440	6	35	61	400	④
			Axis-FP 710-4D/2.2-6/40/AL	2.2	1440	6	40	61	400	⑤
			Axis-FP 710-4D/3-6/45/AL	3	1440	6	45	75	500	⑥
Axis-FP 710-6D...300/2										
710	6	3~400	Axis-FP 710-6D/0.25-6/20/AL	0.25	960	6	20	45.5	400	①
			Axis-FP 710-6D/0.25-6/25/AL	0.25	960	6	25	45.5	400	②
			Axis-FP 710-6D/0.37-6/30/AL	0.37	960	6	30	49.5	400	③
			Axis-FP 710-6D/0.55-6/35/AL	0.55	960	6	35	53	400	④
			Axis-FP 710-6D/0.75-6/40/AL	0.75	960	6	40	56	400	⑤
			Axis-FP 710-6D/1.1-6/45/AL	1.1	960	6	45	60	400	⑥

Standard size: 710
Number of poles: 4
Fire resistance rating: 300/2

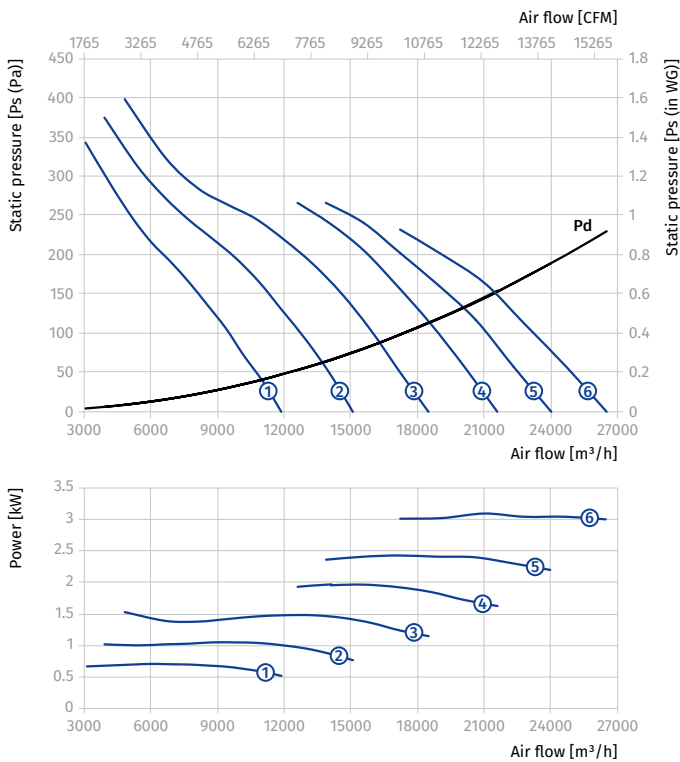

Standard size: 710
Number of poles: 6
Fire resistance rating: 300/2

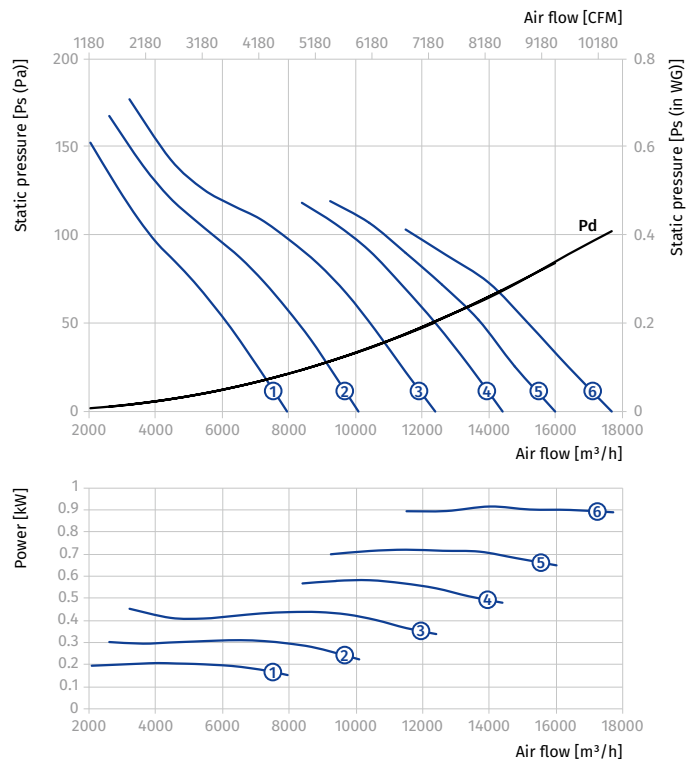

AXIS-FP 710...300/2

Size	Number of poles	Voltage [V/50 Hz]	Fan model	Installed motor power N_y [kW]	RPM [min^{-1}]	Number of blades	Blade setting angle [°]	Weight [kg]	Length L [mm]	Curve number on graph
Axis-FP 710-4/6D...300/2										
710	4/6	3~400	Axis-FP 710-4/6D/0.75/0.25-6/20/AL	0.75/0.25	1440/960	6	20	49	400	①
			Axis-FP 710-4/6D/1.1/0.3-6/25/AL	1.1/0.3	1440/960	6	25	54	400	②
			Axis-FP 710-4/6D/1.5/0.37-6/30/AL	1.5/0.37	1440/960	6	30	58	400	③
			Axis-FP 710-4/6D/2.2/0.7-6/35/AL	2.2/0.7	1440/960	6	35	72	500	④
			Axis-FP 710-4/6D/2.2/0.7-6/40/AL	2.2/0.7	1440/960	6	40	72	500	⑤
			Axis-FP 710-4/6D/3/1-6/45/AL	3/1	1440/960	6	45	81	500	⑥

Standard size: 710
 Number of poles: 4
 Fire resistance rating: 300/2

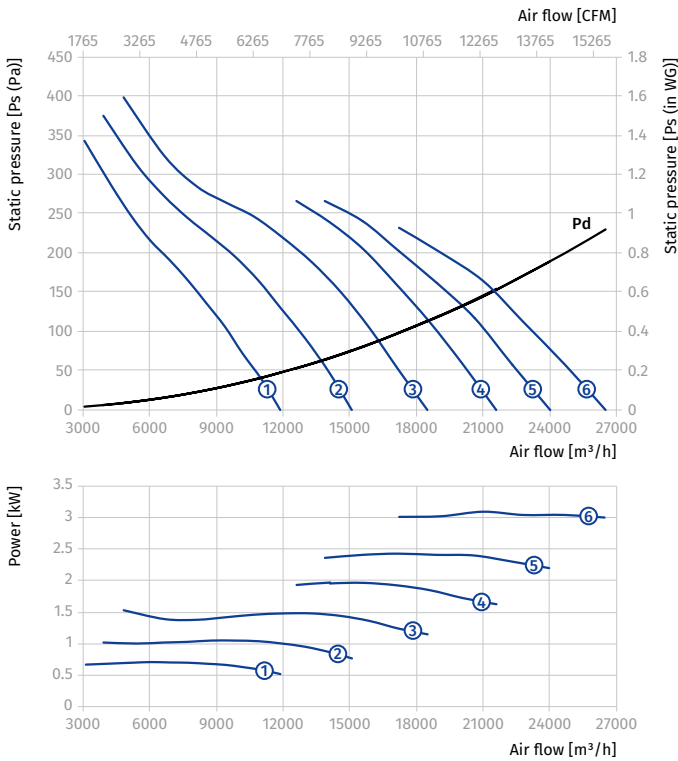

Standard size: 710
 Number of poles: 6
 Fire resistance rating: 300/2

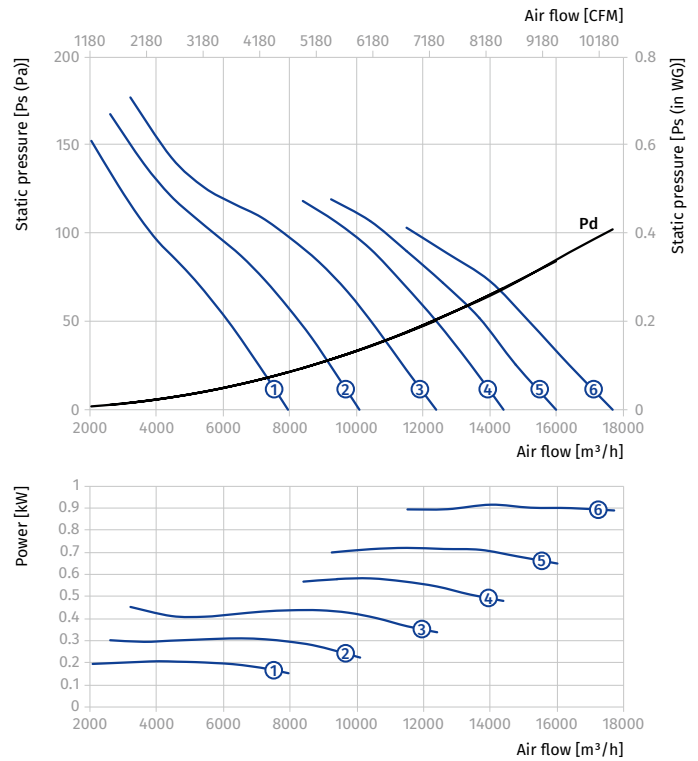

AXIS-FP 710...300/2

Size	Number of poles	Voltage [V/50 Hz]	Fan model	Installed motor power Ny [kW]	RPM [min ⁻¹]	Number of blades	Blade setting angle [°]	Weight [kg]	Length L [mm]	Curve number on graph
Axis-FP 710-4/8D...300/2										
710	4/8	3~400	Axis-FP 710-4/8D/0.8/0.2-6/20/AL	0.8/0.2	1440/720	6	20	52	400	①
			Axis-FP 710-4/8D/1.2/0.3-6/25/AL	1.2/0.3	1440/720	6	25	58	400	②
			Axis-FP 710-4/8D/1.6/0.4-6/30/AL	1.6/0.4	1440/720	6	30	61	400	③
			Axis-FP 710-4/8D/2.2/0.55-6/35/AL	2.2/0.55	1440/720	6	35	75	500	④
			Axis-FP 710-4/8D/2.2/0.55-6/40/AL	2.2/0.55	1440/720	6	40	75	500	⑤
			Axis-FP 710-4/8D/2.8/0.7-6/45/AL	2.8/0.7	1440/720	6	45	78	500	⑥

Standard size: 710
Number of poles: 4
Fire resistance rating: 300/2

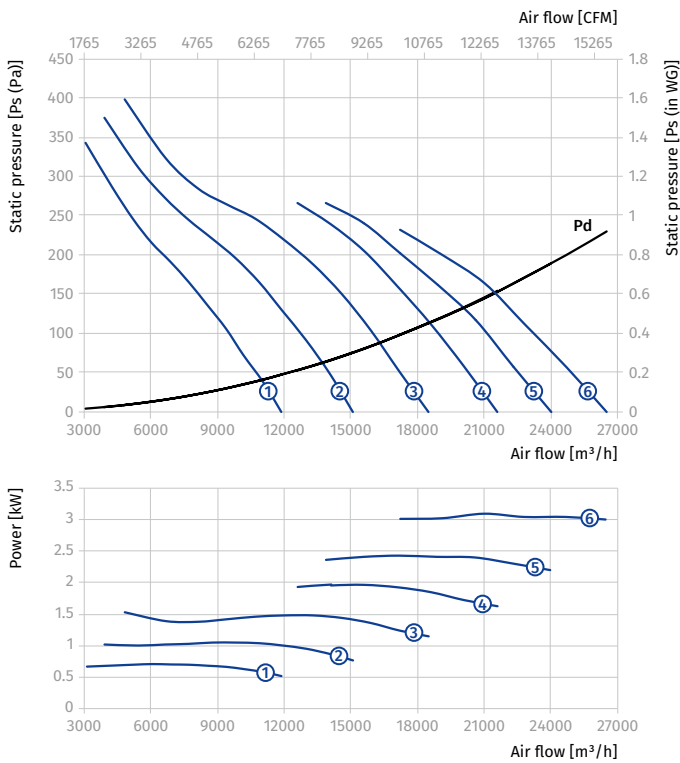

Standard size: 710
Number of poles: 8
Fire resistance rating: 300/2

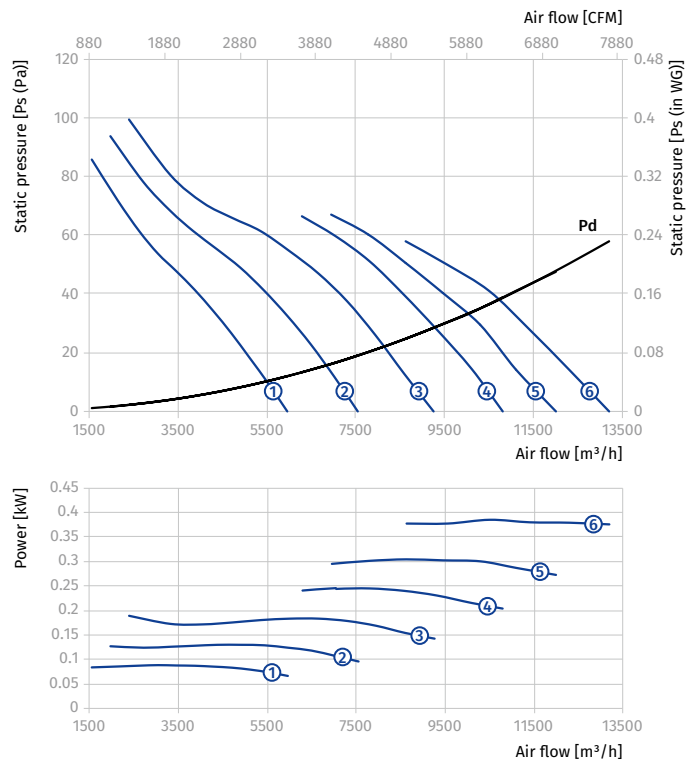

AXIS-FP 800...300/2

Size	Number of poles	Voltage [V/50 Hz]	Fan model	Installed motor power N_y [kW]	RPM [min^{-1}]	Number of blades	Blade setting angle [°]	Weight [kg]	Length L [mm]	Curve number on graph
Axis-FP 800-4D...300/2										
800	4	3~400	Axis-FP 800-4D/1.1-6/20/AL	1.1	1440	6	20	59.5	400	①
			Axis-FP 800-4D/1.5-6/25/AL	1.5	1440	6	25	65.5	400	②
			Axis-FP 800-4D/2.2-6/30/AL	2.2	1440	6	30	65.5	400	③
			Axis-FP 800-4D/3-6/32.5/AL	3	1440	6	32.5	80	500	④
			Axis-FP 800-4D/3-6/35/AL	3	1440	6	35	80	500	⑤
			Axis-FP 800-4D/4-6/37.5/AL	4	1440	6	37.5	85	500	⑥
			Axis-FP 800-4D/4-6/40/AL	4	1440	6	40	85	500	⑦
			Axis-FP 800-4D/5.5-6/45/AL	5.5	1440	6	45	104	550	⑧
Axis-FP 800-6D...300/2										
800	6	3~400	Axis-FP 800-6D/0.37-6/20/AL	0.37	960	6	20	53.5	400	①
			Axis-FP 800-6D/0.55-6/25/AL	0.55	960	6	25	56.5	400	②
			Axis-FP 800-6D/0.75-6/30/AL	0.75	960	6	30	60.5	400	③
			Axis-FP 800-6D/0.75-6/32.5/AL	0.75	960	6	32.5	60.5	400	④
			Axis-FP 800-6D/1.1-6/35/AL	1.1	960	6	35	64.5	400	⑤
			Axis-FP 800-6D/1.1-6/37.5/AL	1.1	960	6	37.5	64.5	400	⑥
			Axis-FP 800-6D/1.1-6/40/AL	1.1	960	6	40	64.5	400	⑦
			Axis-FP 800-6D/1.5-6/45/AL	1.5	960	6	45	77	500	⑧

Standard size: 800
 Number of poles: 4
 Fire resistance rating: 300/2

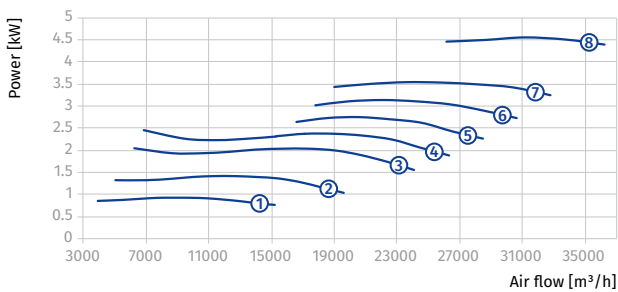
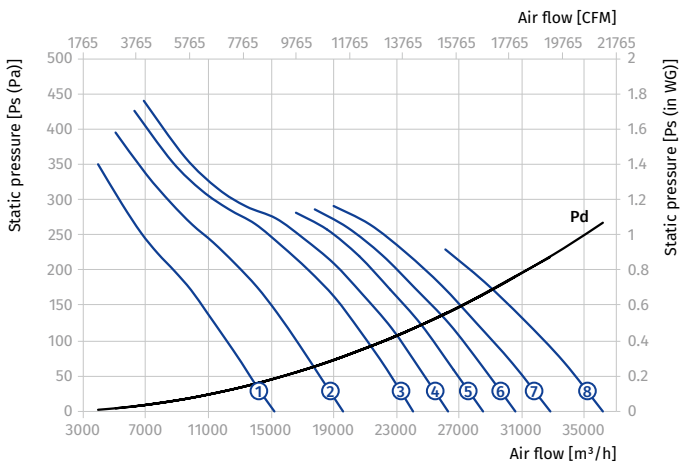

Standard size: 800
 Number of poles: 6
 Fire resistance rating: 300/2

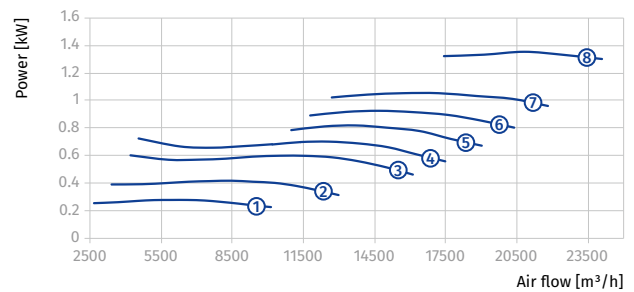
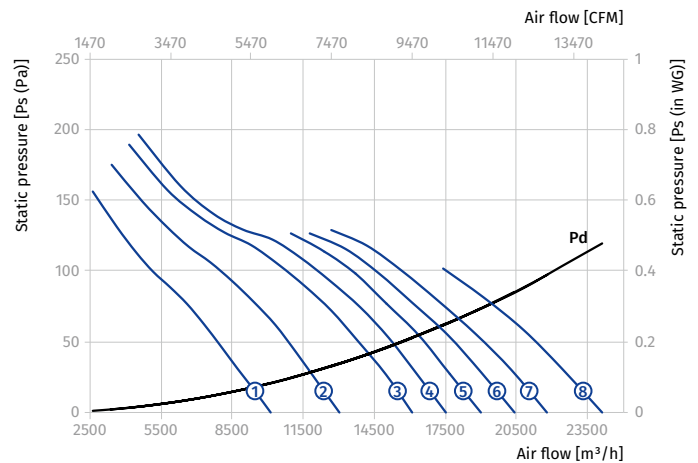

AXIS-FP 800...300/2

Size	Number of poles	Voltage [V/50 Hz]	Fan model	Installed motor power Ny [kW]	RPM [min ⁻¹]	Number of blades	Blade setting angle [°]	Weight [kg]	Length L [mm]	Curve number on graph
Axis-FP 800-4/6D...300/2										
800	4/6	3~400	Axis-FP 800-4/6D/1.1/0.3-6/20/AL	1.1/0.3	1440/960	6	20	58.5	400	①
			Axis-FP 800-4/6D/1.5/0.37-6/25/AL	1.5/0.37	1440/960	6	25	62.5	400	②
			Axis-FP 800-4/6D/2.2/0.7-6/30/AL	2.2/0.7	1440/960	6	30	77	500	③
			Axis-FP 800-4/6D/2.2/0.7-6/32.5/AL	2.2/0.7	1440/960	6	32.5	77	500	④
			Axis-FP 800-4/6D/3/1-6/35/AL	3/1	1440/960	6	35	88	500	⑤
			Axis-FP 800-4/6D/3/1-6/37.5/AL	3/1	1440/960	6	37.5	88	500	⑥
			Axis-FP 800-4/6D/4.5/1.5-6/45/AL	4.5/1.5	1440/960	6	45	125	550	⑦

Standard size: 800
Number of poles: 4
Fire resistance rating: 300/2

Standard size: 800
Number of poles: 6
Fire resistance rating: 300/2

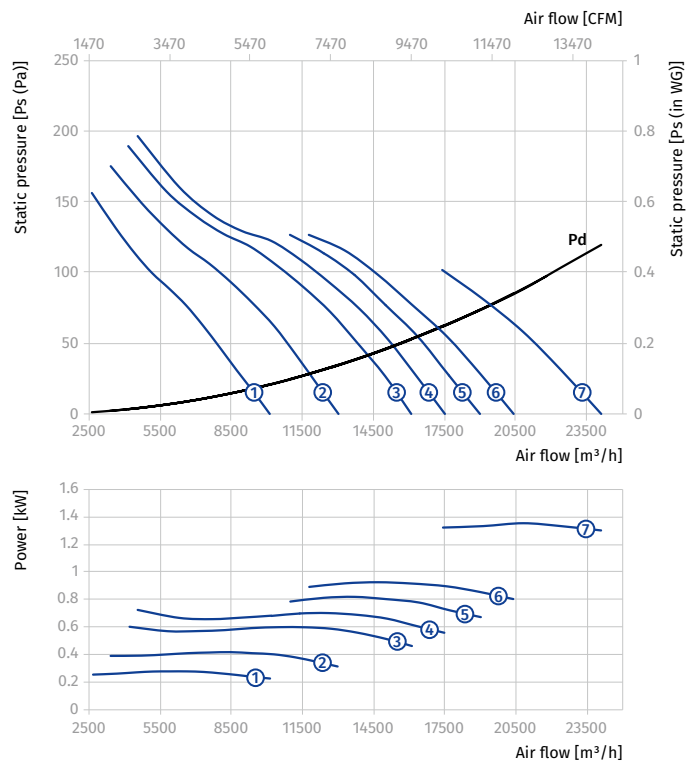
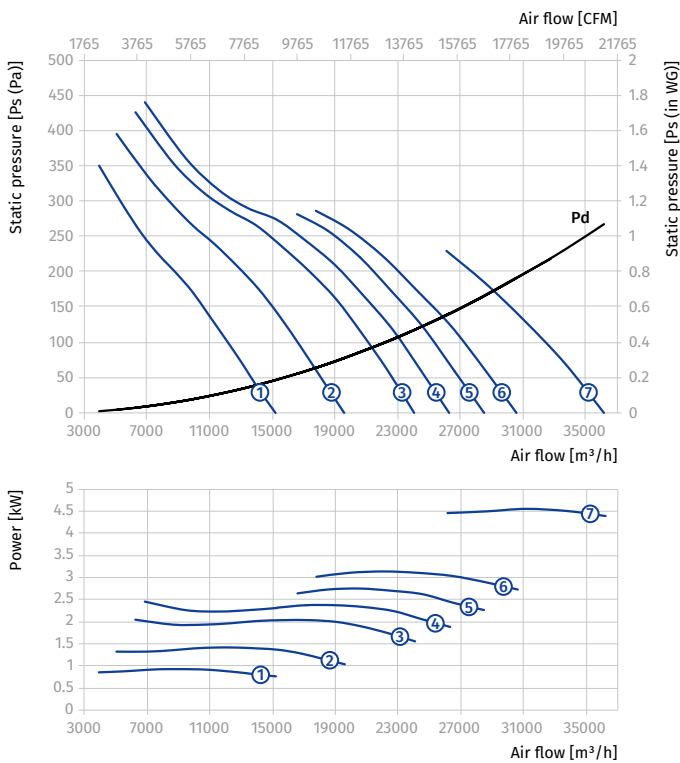

AXIS-FP 800...300/2

Size	Number of poles	Voltage [V/50 Hz]	Fan model	Installed motor power N_y [kW]	RPM [min ⁻¹]	Number of blades	Blade setting angle [°]	Weight [kg]	Length L [mm]	Curve number on graph
Axis-FP 800-4/8D...300/2										
800	4/8	3~400	Axis-FP 800-4/8D/1.2/0.3-6/20/AL	1.2/0.3	1440/720	6	20	62.5	400	①
			Axis-FP 800-4/8D/1.6/0.4-6/25/AL	1.6/0.4	1440/720	6	25	65.5	400	②
			Axis-FP 800-4/8D/2.2/0.55-6/30/AL	2.2/0.55	1440/720	6	30	80	500	③
			Axis-FP 800-4/8D/2.8/0.7-6/32.5/AL	2.8/0.7	1440/720	6	32.5	83	500	④
			Axis-FP 800-4/8D/2.8/0.7-6/35/AL	2.8/0.7	1440/720	6	35	83	500	⑤
			Axis-FP 800-4/8D/3.8/1-6/37.5/AL	3.8/1	1440/720	6	37.5	95	500	⑥
			Axis-FP 800-4/8D/3.8/1-6/40/AL	3.8/1	1440/720	6	40	95	500	⑦
			Axis-FP 800-4/8D/5/1.3-6/45/AL	5/1.3	1440/720	6	45	125	550	⑧

Standard size: 800
 Number of poles: 4
 Fire resistance rating: 300/2

Standard size: 800
 Number of poles: 8
 Fire resistance rating: 300/2

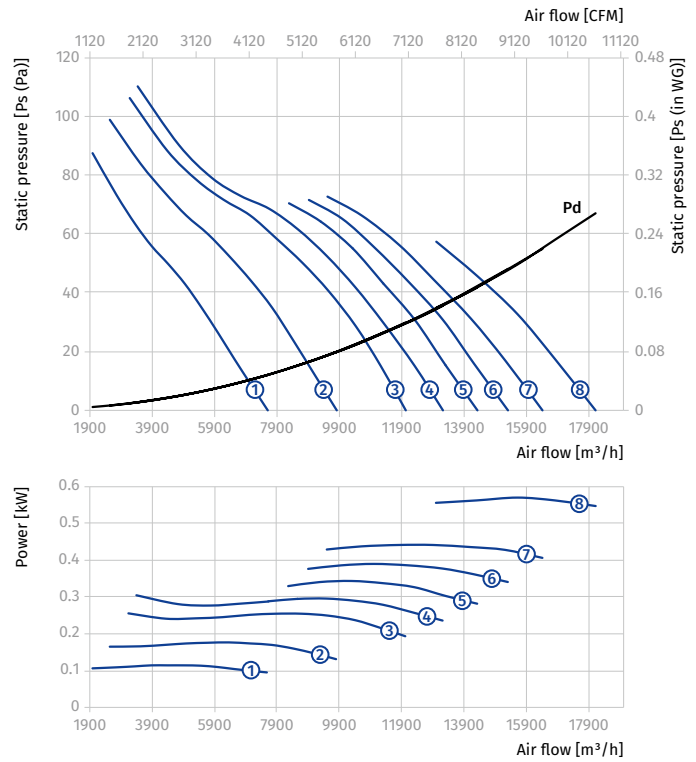
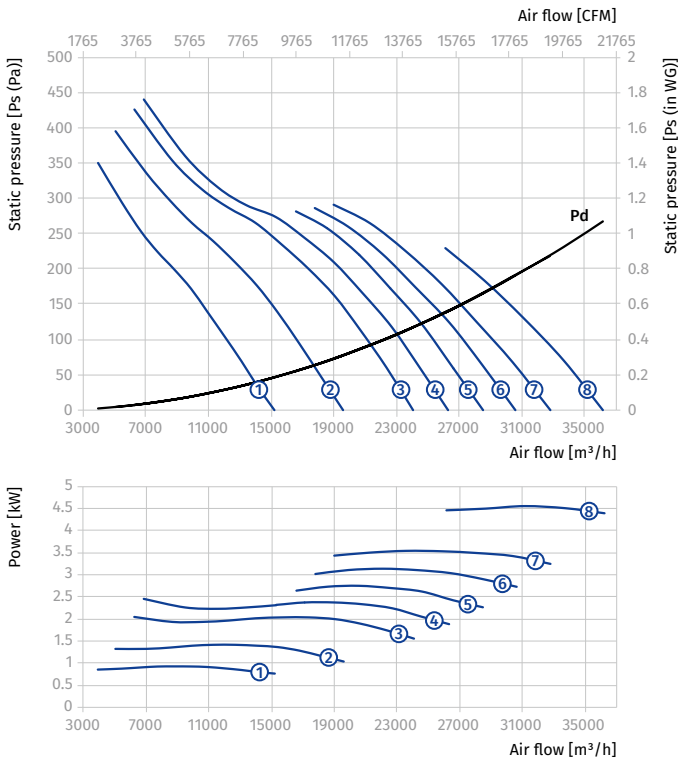

AXIAL SMOKE EXTRACTION FANS

AXIS-FP 900...300/2

Size	Number of poles	Voltage [V/50 Hz]	Fan model	Installed motor power Ny [kW]	RPM [min ⁻¹]	Number of blades	Blade setting angle [°]	Weight [kg]	Length L [mm]	Curve number on graph
Axis-FP 900-4D...300/2										
900	4	3~400	Axis-FP 900-4D/3-8/23.5/AL	3	1440	8	23.5	92	550	①
			Axis-FP 900-4D/4-8/28.5/AL	4	1440	8	28.5	97	550	②
			Axis-FP 900-4D/5.5-8/33.5/AL	5.5	1440	8	33.5	132.5	600	③
			Axis-FP 900-4D/7.5-8/40/AL	7.5	1440	8	40	150	600	④
			Axis-FP 900-4D/11-8/45/AL	11	1440	8	45	168.5	600	⑤
Axis-FP 900-6D...300/2										
900	6	3~400	Axis-FP 900-6D/0.75-8/23.5/AL	0.75	960	8	23.5	71.5	450	①
			Axis-FP 900-6D/1.1-8/28.5/AL	1.1	960	8	28.5	75.5	450	②
			Axis-FP 900-6D/1.5-8/33.5/AL	1.5	960	8	33.5	89	550	③
			Axis-FP 900-6D/2.2-8/41/AL	2.2	960	8	41	101	550	④
			Axis-FP 900-6D/3-8/45/AL	3	960	8	45	104.5	600	⑤

Standard size: 900
Number of poles: 4
Fire resistance rating: 300/2

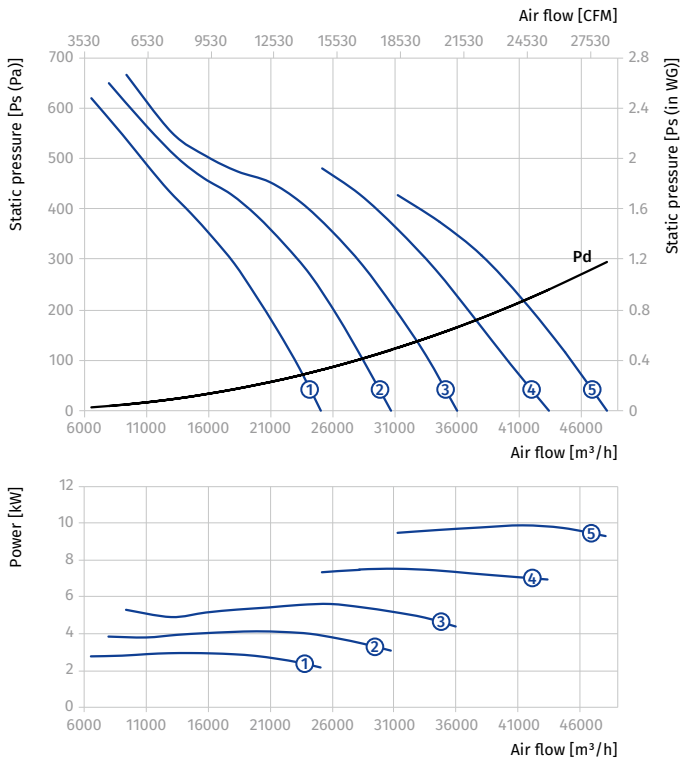

Standard size: 900
Number of poles: 6
Fire resistance rating: 300/2

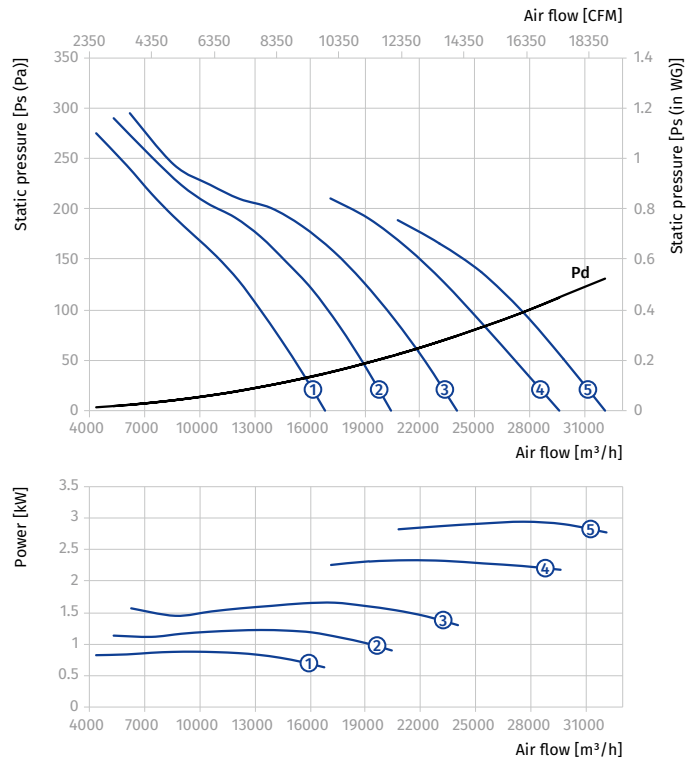

AXIS-FP 900...300/2

Size	Number of poles	Voltage [V/50 Hz]	Fan model	Installed motor power N_y [kW]	RPM [min^{-1}]	Number of blades	Blade setting angle [°]	Weight [kg]	Length L [mm]	Curve number on graph
Axis-FP 900-4/6D...300/2										
900	4/6	3~400	Axis-FP 900-4/6D/3/1-8/23.5/AL	3/1	1440/960	8	23.5	100	550	①
			Axis-FP 900-4/6D/4.5/1.5-8/28.5/AL	4.5/1.5	1440/960	8	28.5	153.5	600	②
			Axis-FP 900-4/6D/6/2.2-8/33.5/AL	6/2.2	1440/960	8	33.5	164.5	600	③
			Axis-FP 900-4/6D/10/3.3-8/45/AL	10/3.3	1440/960	8	45	227.5	750	④

Standard size: 900
 Number of poles: 4
 Fire resistance rating: 300/2

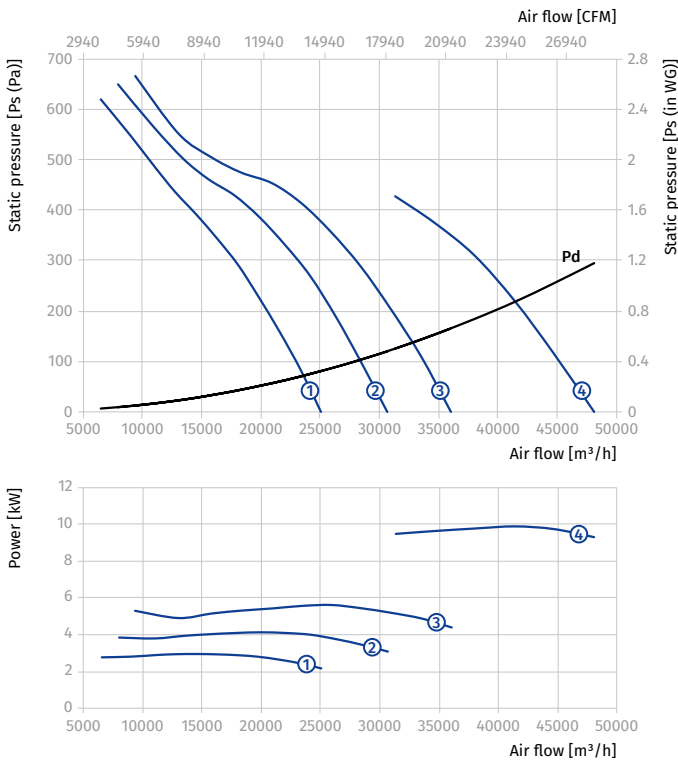

Standard size: 900
 Number of poles: 6
 Fire resistance rating: 300/2

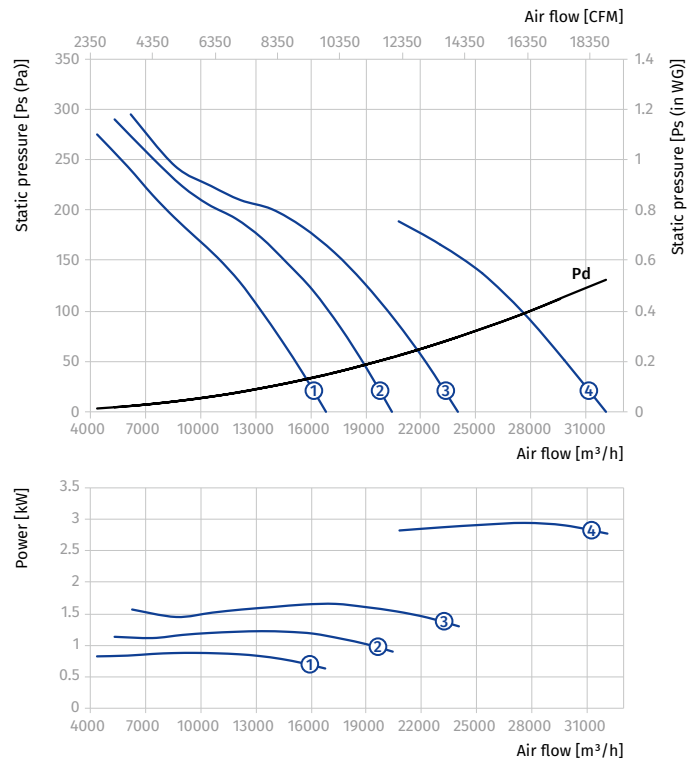

AXIS-FP 900...300/2

Size	Number of poles	Voltage [V/50 Hz]	Fan model	Installed motor power Ny [kW]	RPM [min ⁻¹]	Number of blades	Blade setting angle [°]	Weight [kg]	Length L [mm]	Curve number on graph
Axis-FP 900-4/8D...300/2										
900	4/8	3~400	Axis-FP 900-4/8D/2.8/0.7-8/23.5/AL	2.8/0.7	1440/720	8	23.5	95	550	①
			Axis-FP 900-4/8D/3.8/1-8/28.5/AL	3.8/1	1440/720	8	28.5	107	550	②
			Axis-FP 900-4/8D/5/1.3-8/33.5/AL	5/1.3	1440/720	8	33.5	153.5	600	③
			Axis-FP 900-4/8D/7.2/1.8-8/40/AL	7.2/1.8	1440/720	8	40	165.5	600	④
			Axis-FP 900-4/8D/11/3-8/45/AL	11/3	1440/720	8	45	226.5	750	⑤

Standard size: 900
Number of poles: 4
Fire resistance rating: 300/2

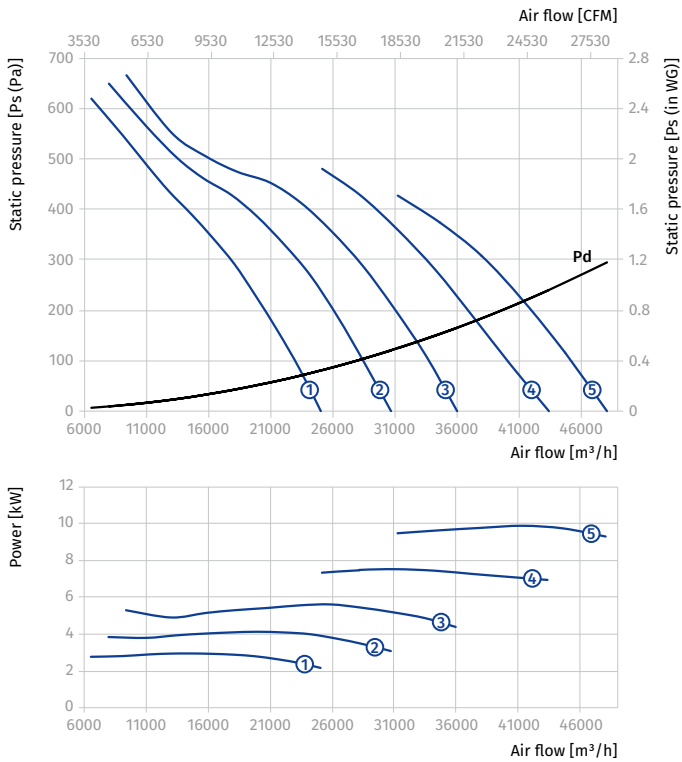

Standard size: 900
Number of poles: 8
Fire resistance rating: 300/2

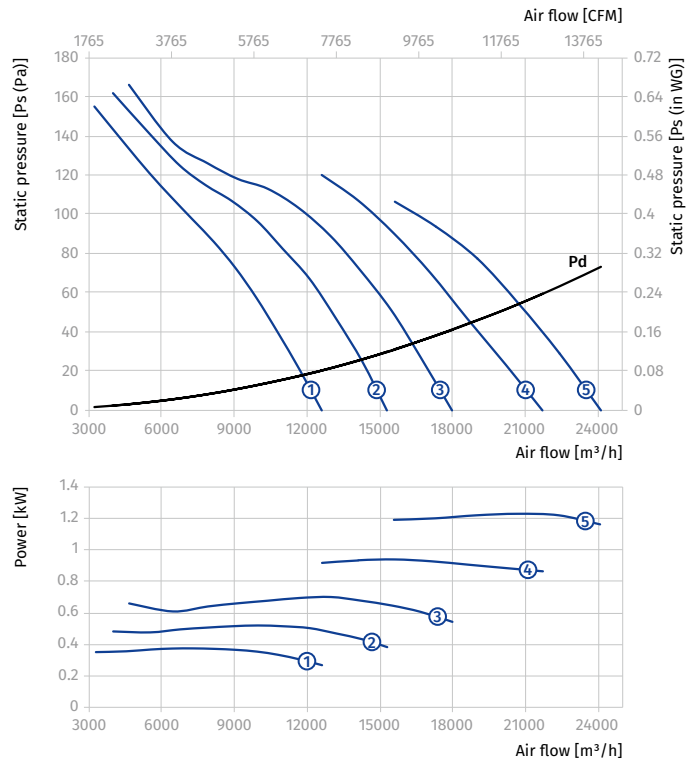

AXIS-FP 1000...300/2

Size	Number of poles	Voltage [V/50 Hz]	Fan model	Installed motor power Ny [kW]	RPM [min ⁻¹]	Number of blades	Blade setting angle [°]	Weight [kg]	Length L [mm]	Curve number on graph
Axis-FP 1000-4D...300/2										
1000	4	3~400	Axis-FP 1000-4D/5.5-6/24/AL	5.5	1440	6	24	147.5	600	①
			Axis-FP 1000-4D/7.5-6/30/AL	7.5	1440	6	30	165	600	②
			Axis-FP 1000-4D/9.2-6/33/AL	9.2	1440	6	33	170.5	600	③
			Axis-FP 1000-4D/11-6/36/AL	11	1440	6	36	183.5	600	④
			Axis-FP 1000-4D/15-6/43/AL	15	1440	6	43	244	750	⑤
			Axis-FP 1000-4D/18.5-6/48/AL	18.5	1440	6	48	259	750	⑥
Axis-FP 1000-6D...300/2										
1000	6	3~400	Axis-FP 1000-6D/1.5-6/23/AL	1.5	960	6	23	101	550	①
			Axis-FP 1000-6D/2.2-6/29/AL	2.2	960	6	29	114	550	②
			Axis-FP 1000-6D/3-6/35/AL	3	960	6	35	155.5	600	③
			Axis-FP 1000-6D/4-6/41/AL	4	960	6	41	159.5	600	④
			Axis-FP 1000-6D/5.5-6/48/AL	5.5	960	6	48	172.5	600	⑤

Standard size: 1000
 Number of poles: 4
 Fire resistance rating: 300/2

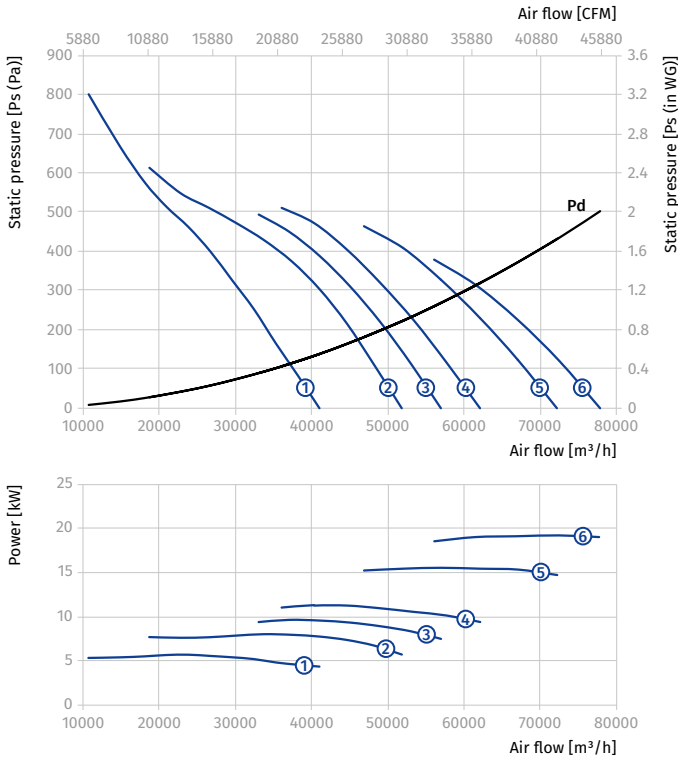

Standard size: 1000
 Number of poles: 6
 Fire resistance rating: 300/2

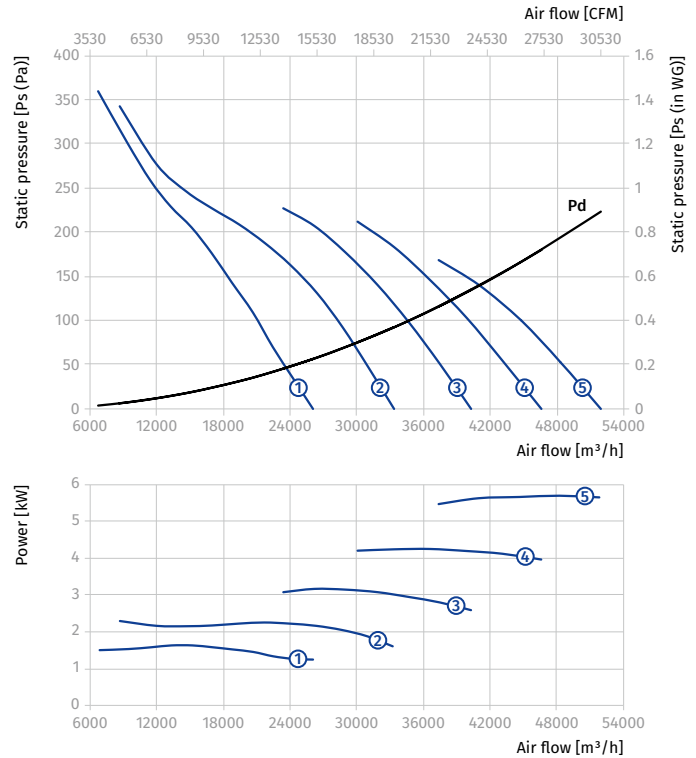

AXIS-FP 1000...300/2

Size	Number of poles	Voltage [V/50 Hz]	Fan model	Installed motor power Ny [kW]	RPM [min ⁻¹]	Number of blades	Blade setting angle [°]	Weight [kg]	Length L [mm]	Curve number on graph
Axis-FP 1000-4/6D...300/2										
1000	4/6	3~400	Axis-FP 1000-4/6D/4.5/1.5-6/20/AL	4.5/1.5	1440/960	6	20	168.5	600	①
			Axis-FP 1000-4/6D/6/2.2-6/25/AL	6/2.2	1440/960	6	25	179.5	600	②
			Axis-FP 1000-4/6D/10/3.3-6/34/AL	10/3.3	1440/960	6	34	244.5	750	③
			Axis-FP 1000-4/6D/14/4.5-6/41/AL	14/4.5	1440/960	6	41	259.5	750	④
			Axis-FP 1000-4/6D/16/6.5-6/45/AL	16/6.5	1440/960	6	45	328	800	⑤

Standard size: 1000
Number of poles: 4
Fire resistance rating: 300/2

Standard size: 1000
Number of poles: 6
Fire resistance rating: 300/2

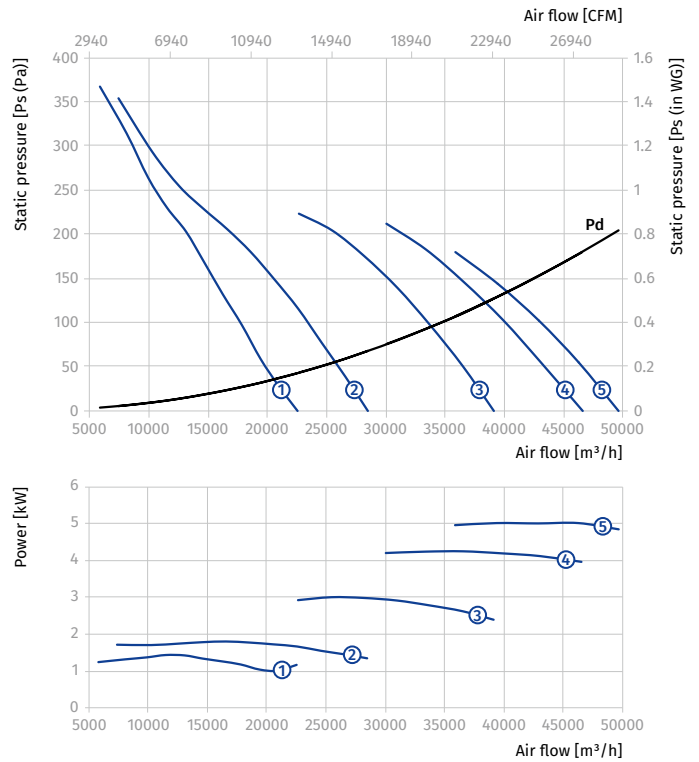
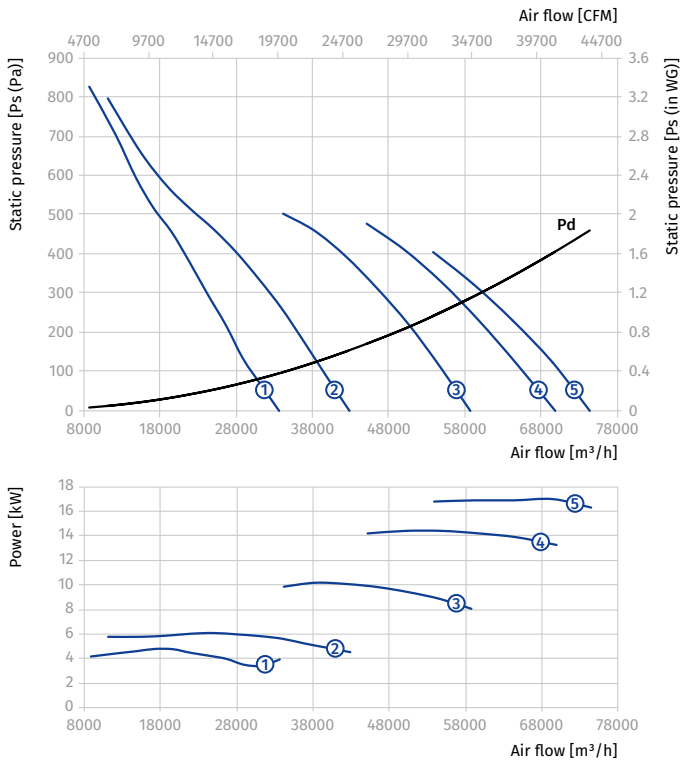

AXIS-FP 1000...300/2

Size	Number of poles	Voltage [V/50 Hz]	Fan model	Installed motor power N_y [kW]	RPM [min^{-1}]	Number of blades	Blade setting angle [°]	Weight [kg]	Length L [mm]	Curve number on graph
Axis-FP 1000-4/8D...300/2										
1000	4/8	3~400	Axis-FP 1000-4/8D/5/1.3-6/23/AL	5/1.3	1440/720	6	23	168.5	600	①
			Axis-FP 1000-4/8D/7.2/1.8-6/29/AL	7.2/1.8	1440/720	6	29	180.5	600	②
			Axis-FP 1000-4/8D/11/3-6/36/AL	11/3	1440/720	6	36	243.5	750	③
			Axis-FP 1000-4/8D/14/3.5-6/41/AL	14/3.5	1440/720	6	41	259.5	750	④
			Axis-FP 1000-4/8D/17/4.3-6/46/AL	17/4.3	1440/720	6	46	295	800	⑤

Standard size: 1000
 Number of poles: 4
 Fire resistance rating: 300/2

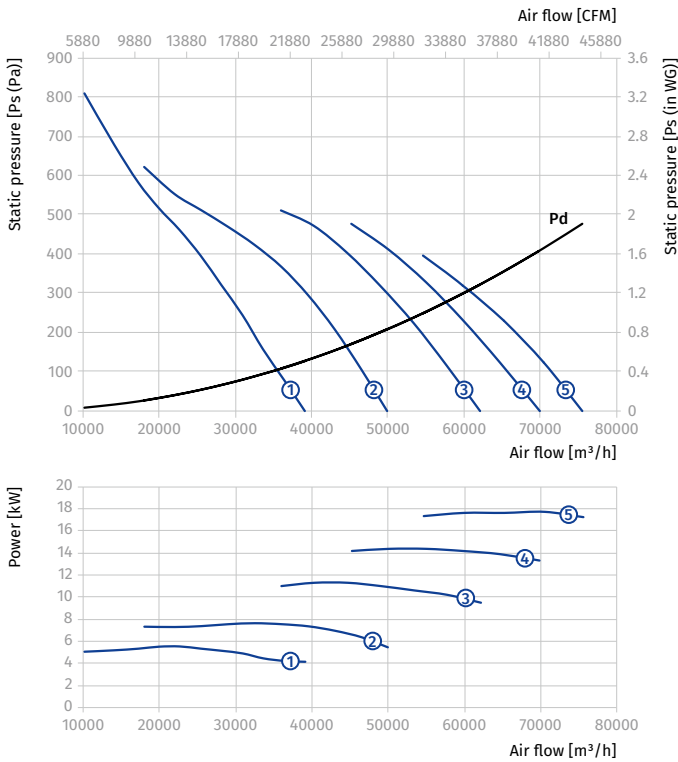

Standard size: 1000
 Number of poles: 8
 Fire resistance rating: 300/2

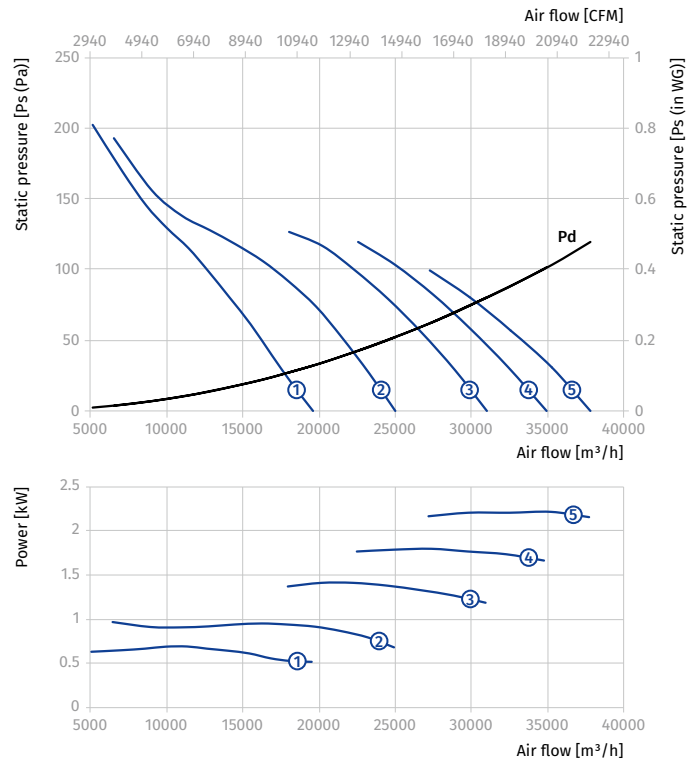

AXIAL SMOKE EXTRACTION FANS

AXIS-FP 1120...300/2

Size	Number of poles	Voltage [V/50 Hz]	Fan model	Installed motor power Ny [kW]	RPM [min ⁻¹]	Number of blades	Blade setting angle [°]	Weight [kg]	Length L [mm]	Curve number on graph
Axis-FP 1120-4D...300/2										
1120	4	3~400	Axis-FP 1120-4D/7.5-6/23/AL	7.5	1440	6	23	183	600	①
			Axis-FP 1120-4D/9.2-6/27/AL	9.2	1440	6	27	189	600	②
			Axis-FP 1120-4D/11-6/31/AL	11	1440	6	31	202	600	③
			Axis-FP 1120-4D/15-6/35/AL	15	1440	6	35	296	750	④
			Axis-FP 1120-4D/18.5-6/40/AL	18.5	1440	6	40	312	750	⑤
			Axis-FP 1120-4D/22-6/43/AL	22	1440	6	43	352	800	⑥
Axis-FP 1120-6D...300/2										
1120	6	3~400	Axis-FP 1120-6D/2.2-6/23/AL	2.2	960	6	23	146	550	①
			Axis-FP 1120-6D/3-6/29/AL	3	960	6	29	174	600	②
			Axis-FP 1120-6D/4-6/34/AL	4	960	6	34	178	600	③
			Axis-FP 1120-6D/5.5-6/40/AL	5.5	960	6	40	191	600	④
			Axis-FP 1120-6D/7.5-6/46/AL	7.5	960	6	46	280	750	⑤
			Axis-FP 1120-6D/9.2-6/50/AL	9.2	960	6	50	289	750	⑥

Standard size: 1120
Number of poles: 4
Fire resistance rating: 300/2

Standard size: 1120
Number of poles: 6
Fire resistance rating: 300/2

AXIAL SMOKE EXTRACTION FANS

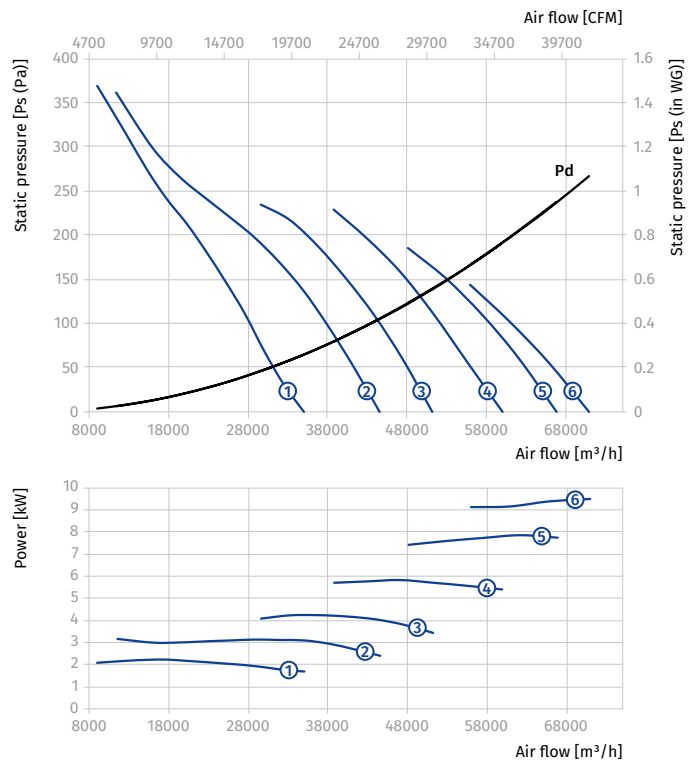
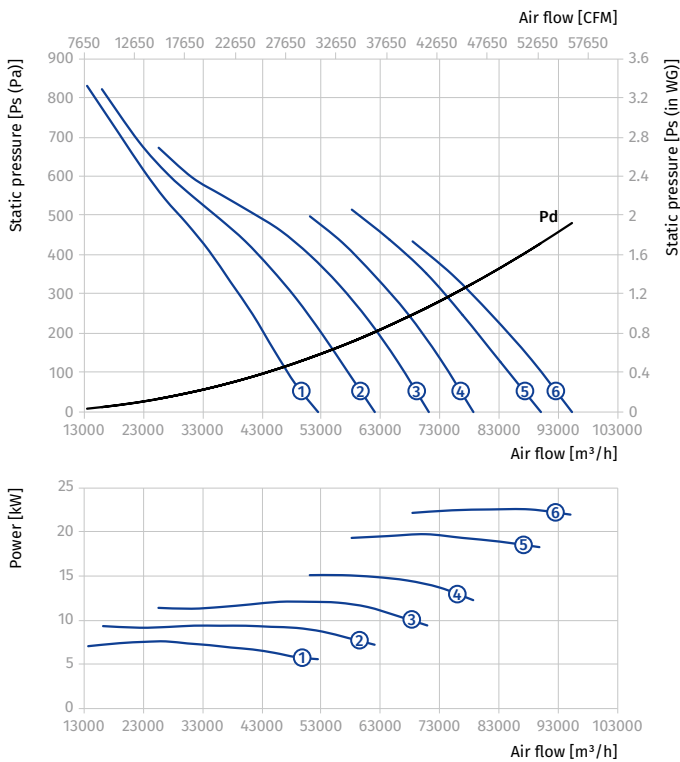

AXIS-FP 1120...300/2

Size	Number of poles	Voltage [V/50 Hz]	Fan model	Installed motor power N_y [kW]	RPM [min^{-1}]	Number of blades	Blade setting angle [°]	Weight [kg]	Length L [mm]	Curve number on graph
Axis-FP 1120-4/6D...300/2										
1120	4/6	3~400	Axis-FP 1120-4/6D/6/2.2-5/24/AL	6/2.2	1440/960	5	24	196	600	①
			Axis-FP 1120-4/6D/10/3.3-6/29/AL	10/3.3	1440/960	6	29	297	750	②
			Axis-FP 1120-4/6D/14/4.5-6/34/AL	14/4.5	1440/960	6	34	312	750	③
			Axis-FP 1120-4/6D/16/6.5-6/37/AL	16/6.5	1440/960	6	37	384	800	④
			Axis-FP 1120-4/6D/20/8.5-6/41/AL	20/8.5	1440/960	6	41	387	800	⑤

Standard size: 1120
 Number of poles: 4
 Fire resistance rating: 300/2

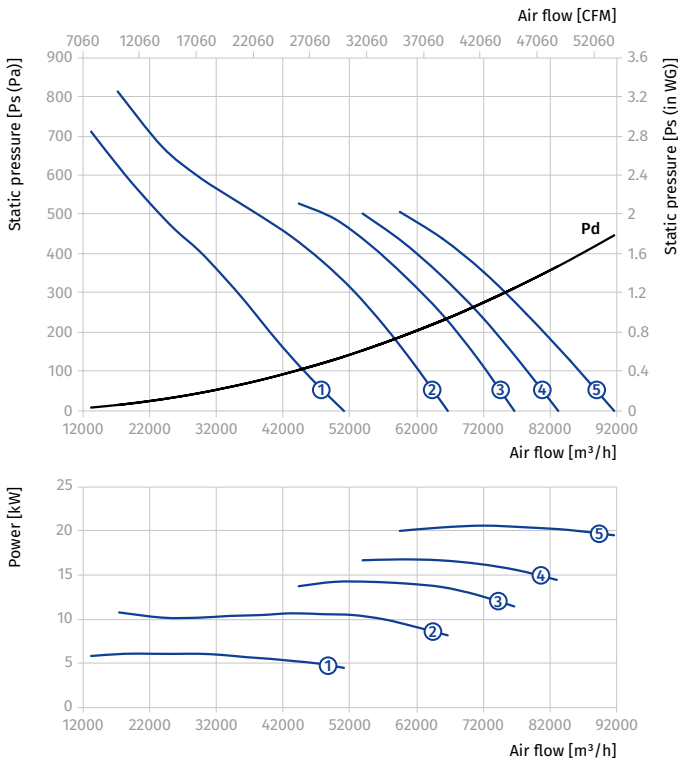

Standard size: 1120
 Number of poles: 6
 Fire resistance rating: 300/2

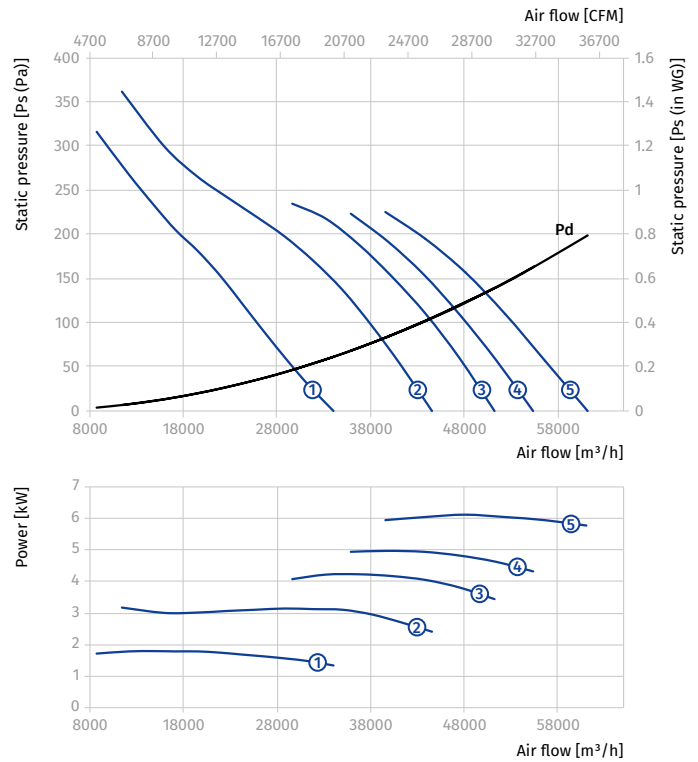

AXIAL SMOKE EXTRACTION FANS

AXIS-FP 1120...300/2

Size	Number of poles	Voltage [V/50 Hz]	Fan model	Installed motor power Ny [kW]	RPM [min ⁻¹]	Number of blades	Blade setting angle [°]	Weight [kg]	Length L [mm]	Curve number on graph
Axis-FP 1120-4/8D...300/2										
1120	4/8	3~400	Axis-FP 1120-4/8D/7.2/1.8-6/23/AL	7.2/1.8	1440/720	6	23	199	600	①
			Axis-FP 1120-4/8D/11/3-6/31/AL	11/3	1440/720	6	31	296	750	②
			Axis-FP 1120-4/8D/14/3.5-6/34/AL	14/3.5	1440/720	6	34	312	750	③
			Axis-FP 1120-4/8D/17/4.3-6/38/AL	17/4.3	1440/720	6	38	351	800	④
			Axis-FP 1120-4/8D/20/5-6/41/AL	20/5	1440/720	6	41	379	800	⑤

Standard size: 1120
Number of poles: 4
Fire resistance rating: 300/2

Standard size: 1120
Number of poles: 8
Fire resistance rating: 300/2

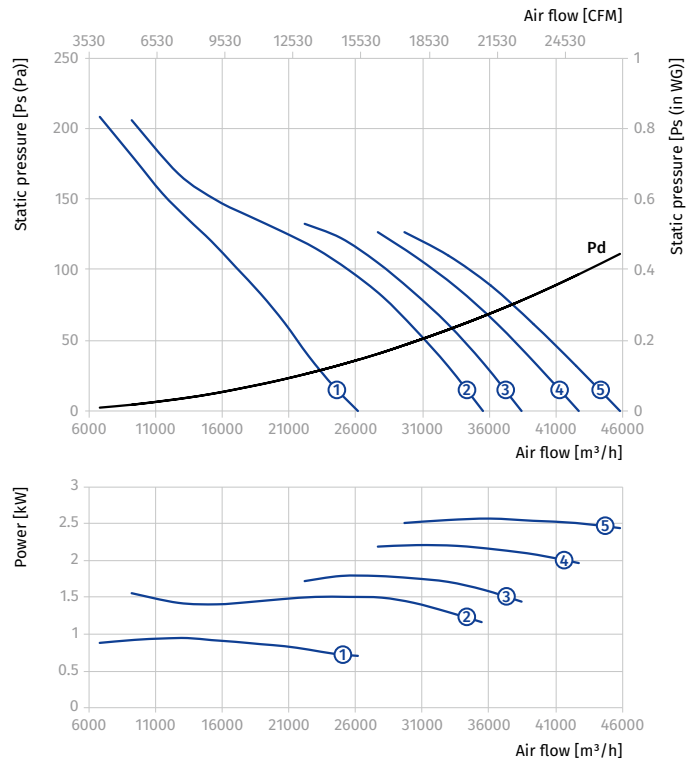
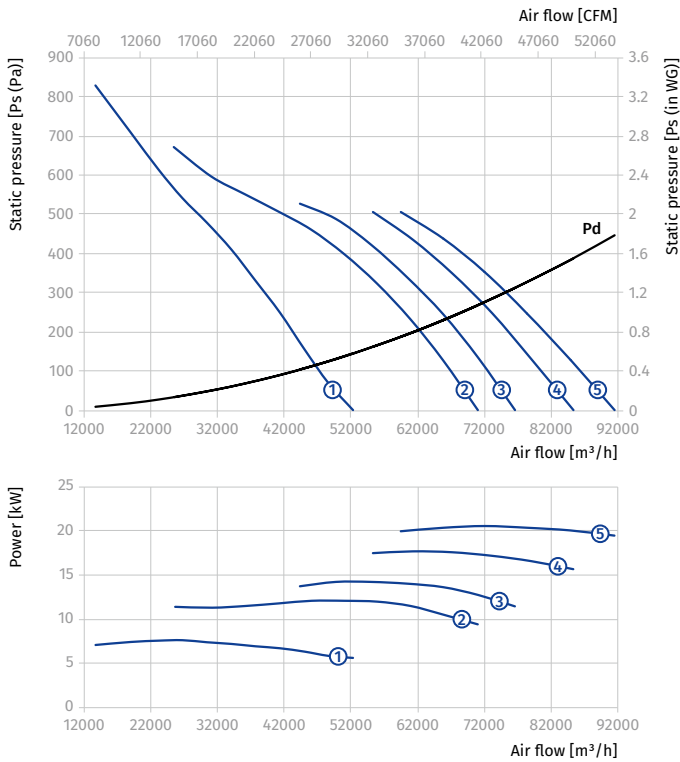

AXIS-FP 1250...300/2

Size	Number of poles	Voltage [V/50 Hz]	Fan model	Installed motor power N_y [kW]	RPM [min^{-1}]	Number of blades	Blade setting angle [°]	Weight [kg]	Length L [mm]	Curve number on graph
Axis-FP 1250-4D...300/2										
1250	4	3~400	Axis-FP 1250-4D/18.5-8/23/AL	18.5	1440	8	23	335	750	①
			Axis-FP 1250-4D/22-8/28/AL	22	1440	8	28	377.5	800	②
			Axis-FP 1250-4D/30-8/34/AL	30	1440	8	34	403.5	800	③
Axis-FP 1250-6D...300/2										
1250	6	3~400	Axis-FP 1250-6D/5.5-8/23/AL	5.5	960	8	23	231	600	①
			Axis-FP 1250-6D/7.5-8/30/AL	7.5	960	8	30	303	750	②
			Axis-FP 1250-6D/9.2-8/34/AL	9.2	960	8	34	303	750	③
			Axis-FP 1250-6D/11-8/38/AL	11	960	8	38	327	750	④

Standard size: 1250
 Number of poles: 4
 Fire resistance rating: 300/2

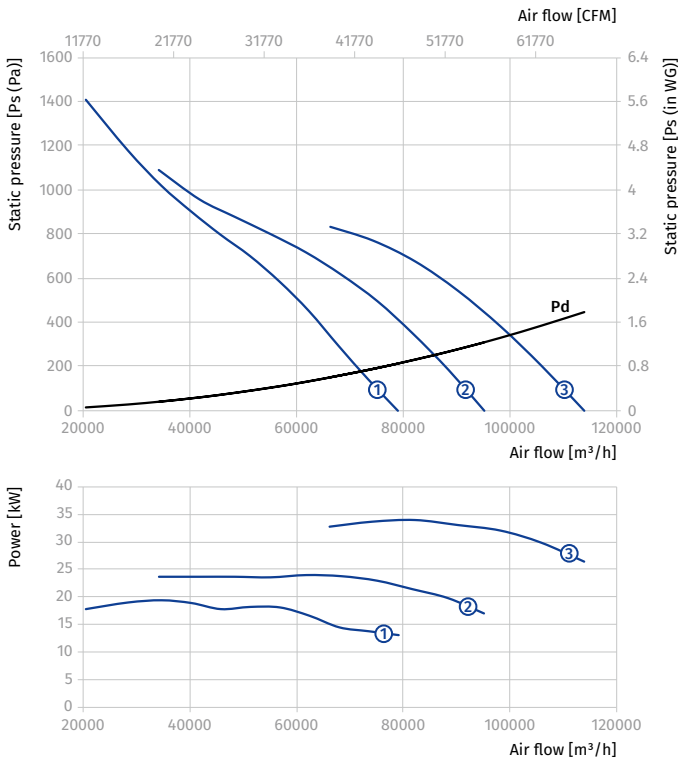

Standard size: 1250
 Number of poles: 6
 Fire resistance rating: 300/2

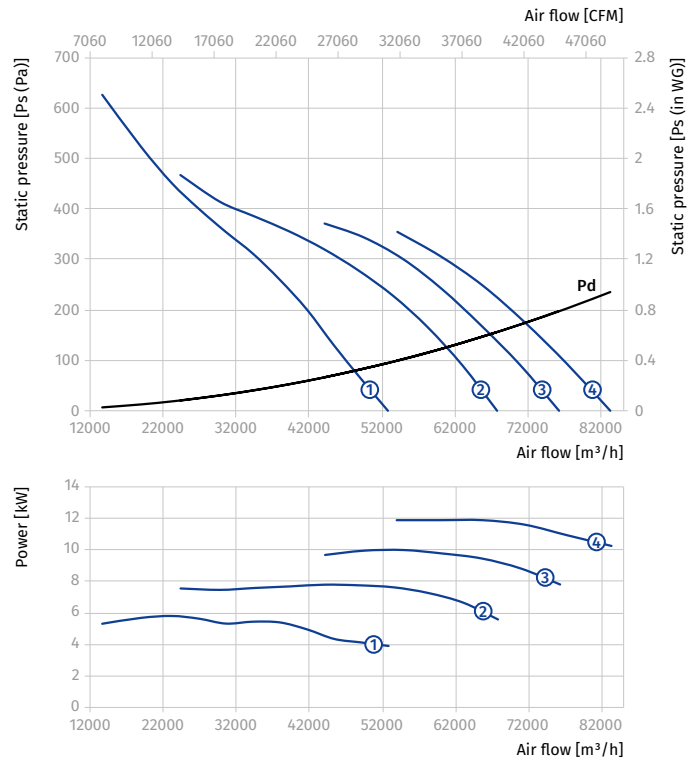

AXIS-FP 1250...300/2

Size	Number of poles	Voltage [V/50 Hz]	Fan model	Installed motor power Ny [kW]	RPM [min ⁻¹]	Number of blades	Blade setting angle [°]	Weight [kg]	Length L [mm]	Curve number on graph
Axis-FP 1250-4/6D...300/2										
1250	4/6	3~400	Axis-FP 1250-4/6D/16/6.5-8/20/AL	16/6.5	1440/960	8	20	408.5	800	①
			Axis-FP 1250-4/6D/20/8.5-8/25/AL	20/8.5	1440/960	8	25	411.5	800	②
			Axis-FP 1250-4/6D/26/9-8/31/AL	26/9	1440/960	8	31	510	850	③

Standard size: 1250
Number of poles: 4
Fire resistance rating: 300/2

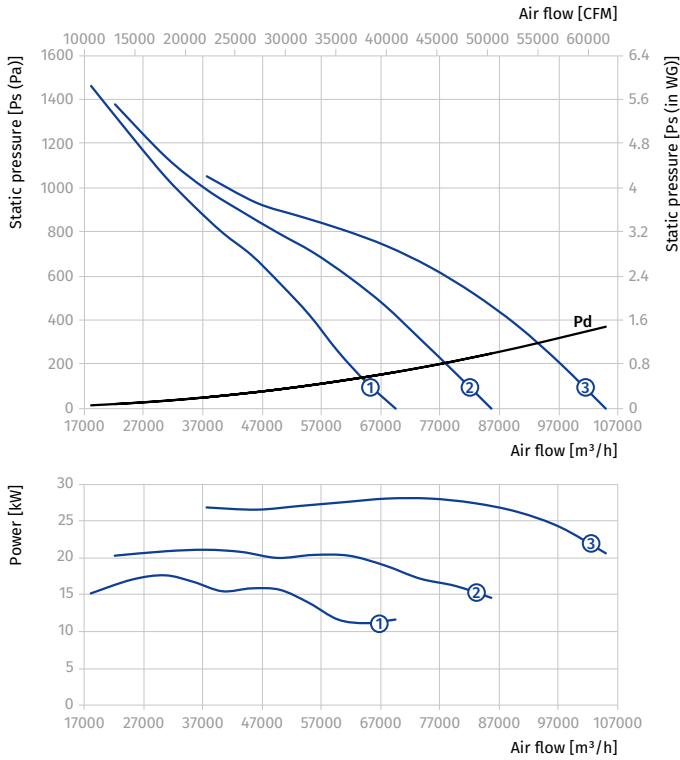

Standard size: 1250
Number of poles: 6
Fire resistance rating: 300/2

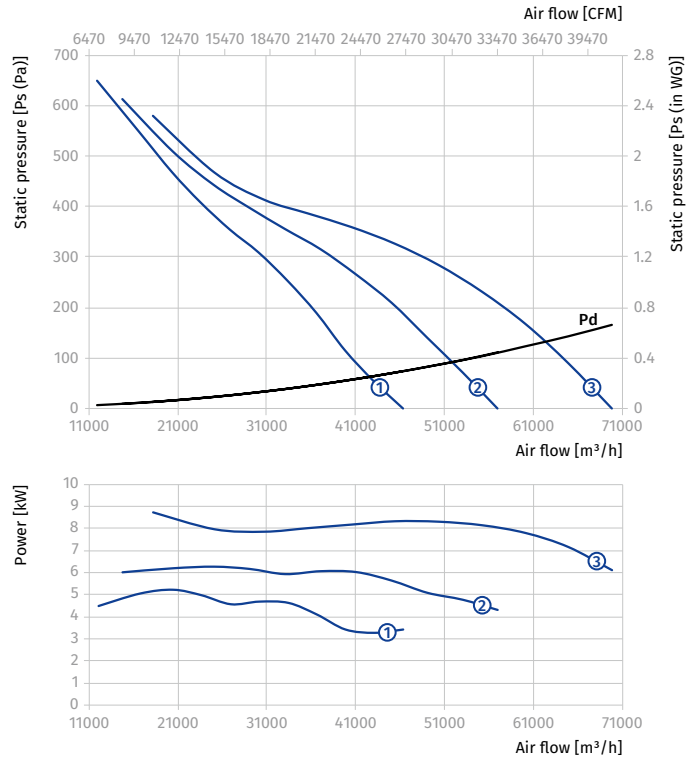

AXIS-FP 1250...300/2

Size	Number of poles	Voltage [V/50 Hz]	Fan model	Installed motor power N_y [kW]	RPM [min^{-1}]	Number of blades	Blade setting angle [°]	Weight [kg]	Length L [mm]	Curve number on graph
Axis-FP 1250-4/8D...300/2										
1250	4/8	3~400	Axis-FP 1250-4/8D/17/4.3-8/21/AL	17/4.3	1440/720	8	21	375.5	800	①
			Axis-FP 1250-4/8D/20/5-8/25/AL	20/5	1440/720	8	25	403.5	800	②
			Axis-FP 1250-4/8D/28/6.5-8/32/AL	28/6.5	1440/720	8	32	465	850	③

Standard size: 1250
 Number of poles: 4
 Fire resistance rating: 300/2

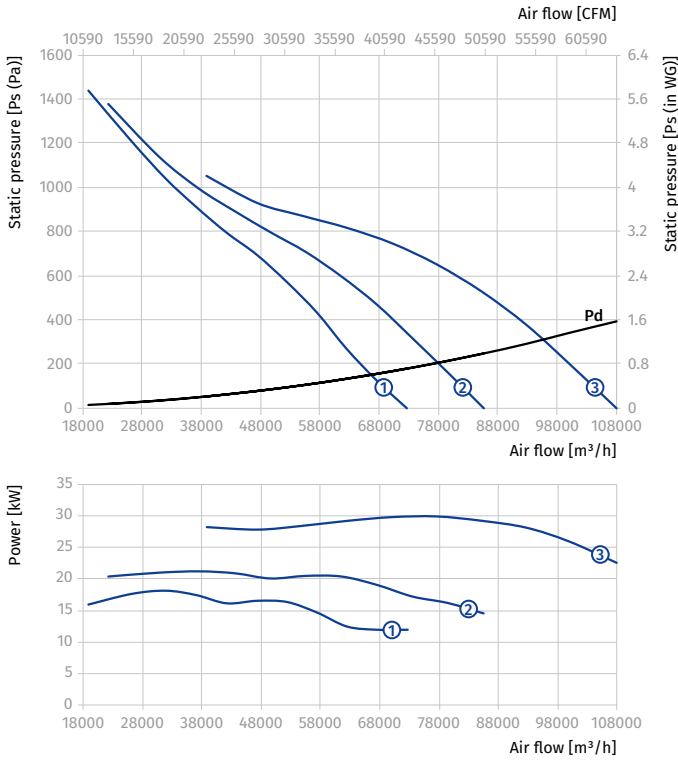

Standard size: 1250
 Number of poles: 8
 Fire resistance rating: 300/2

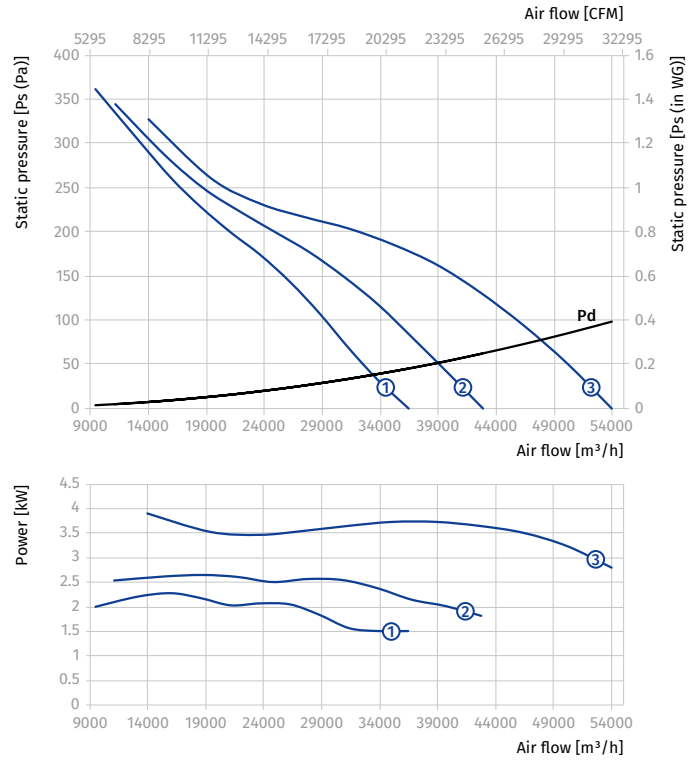

AXIAL SMOKE EXTRACTION FANS

Technical data AXIS-FP...400/2

AXIS-FP 400...400/2

Size	Number of poles	Voltage [V/50 Hz]	Fan model	Installed motor power Ny [kW]	RPM [min ⁻¹]	Number of blades	Blade setting angle [°]	Weight [kg]	Length L [mm]	Curve number on graph
Axis-FP 400-2D...400/2										
400	2	3~400	Axis-FP 400-2D/0.75-4/25/AL	0.75	2880	4	25	25.6	400	①
			Axis-FP 400-2D/1.1-4/35/AL	1.1	2880	4	35	29.7	400	②
			Axis-FP 400-2D/1.5-4/40/AL	1.5	2880	4	40	31.2	400	③
			Axis-FP 400-2D/2.2-6/40/AL	2.2	2880	6	40	33.8	400	④
			Axis-FP 400-2D/2.2-6/45/AL	2.2	2880	6	45	33.8	400	⑤
Axis-FP 400-4D...400/2										
400	4	3~400	Axis-FP 400-4D/0.55-6/30/AL	0.55	1440	6	30	26.1	400	①
			Axis-FP 400-4D/0.55-6/35/AL	0.55	1440	6	35	26.1	400	②
			Axis-FP 400-4D/0.55-6/40/AL	0.55	1440	6	40	25.3	400	③
			Axis-FP 400-4D/0.55-9/40/AL	0.55	1440	9	40	26.5	400	④
			Axis-FP 400-4D/0.55-12/40/AL	0.55	1440	12	40	27.0	400	⑤
			Axis-FP 400-4D/0.55-12/45/AL	0.55	1440	12	45	27.0	400	⑥

Standard size: 400
Number of poles: 2
Fire resistance rating: 400/2

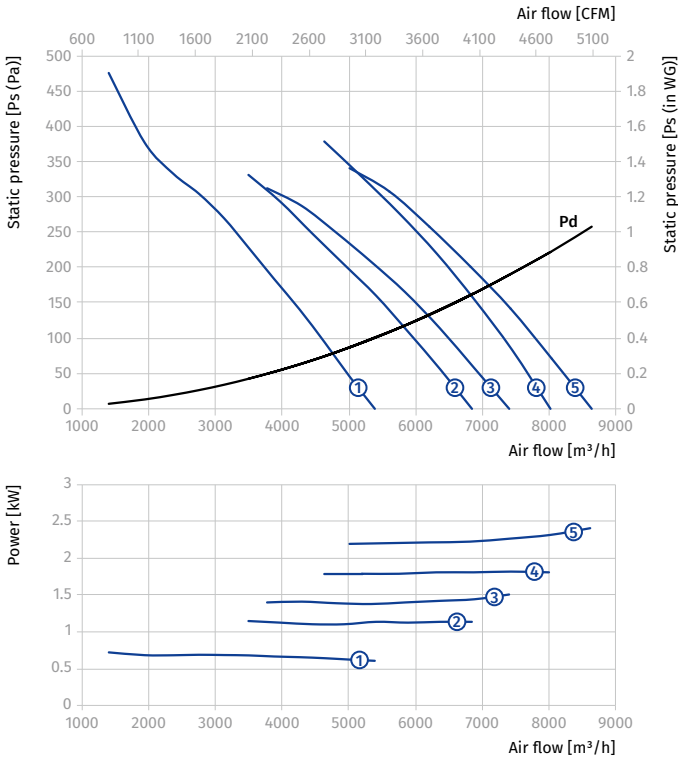

Standard size: 400
Number of poles: 4
Fire resistance rating: 400/2

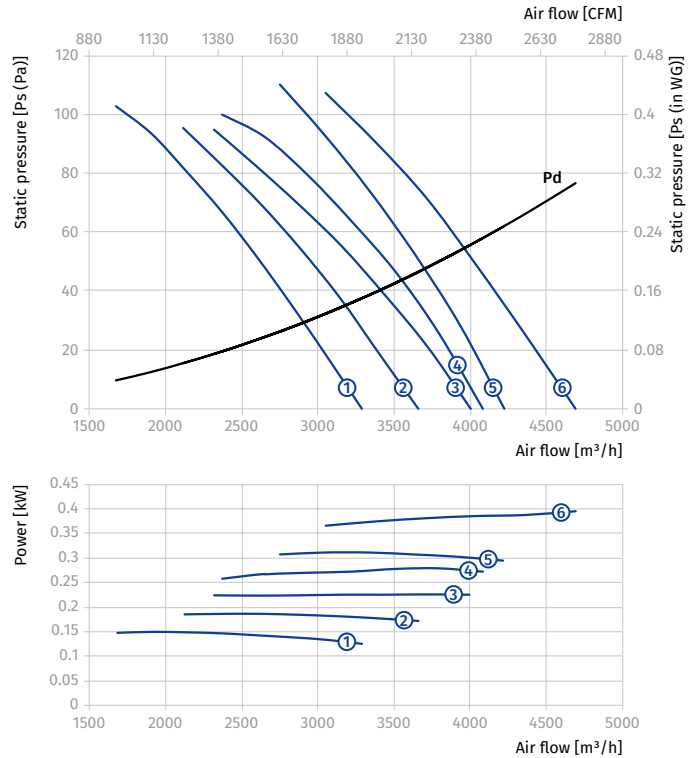

AXIS-FP 400...400/2

Size	Number of poles	Voltage [V/50 Hz]	Fan model	Installed motor power N_y [kW]	RPM [min^{-1}]	Number of blades	Blade setting angle [°]	Weight [kg]	Length L [mm]	Curve number on graph
Axis-FP 400-2/4D...400/2										
400	2/4	3~400	Axis-FP 400-2/4D/0.8/0.2-4/25/AL	0.8/0.2	2880/1440	4	25	30.3	400	①
			Axis-FP 400-2/4D/1.1/0.25-4/35/AL	1.1/0.25	2880/1440	4	35	31.3	400	②
			Axis-FP 400-2/4D/1.5/0.37-4/40/AL	1.5/0.37	2880/1440	4	40	36.8	400	③
			Axis-FP 400-2/4D/2.2/0.5-6/40/AL	2.2/0.5	2880/1440	6	40	39.1	400	④
			Axis-FP 400-2/4D/2.2/0.5-6/45/AL	2.2/0.5	2880/1440	6	45	39.1	400	⑤

Standard size: 400
 Number of poles: 2
 Fire resistance rating: 400/2

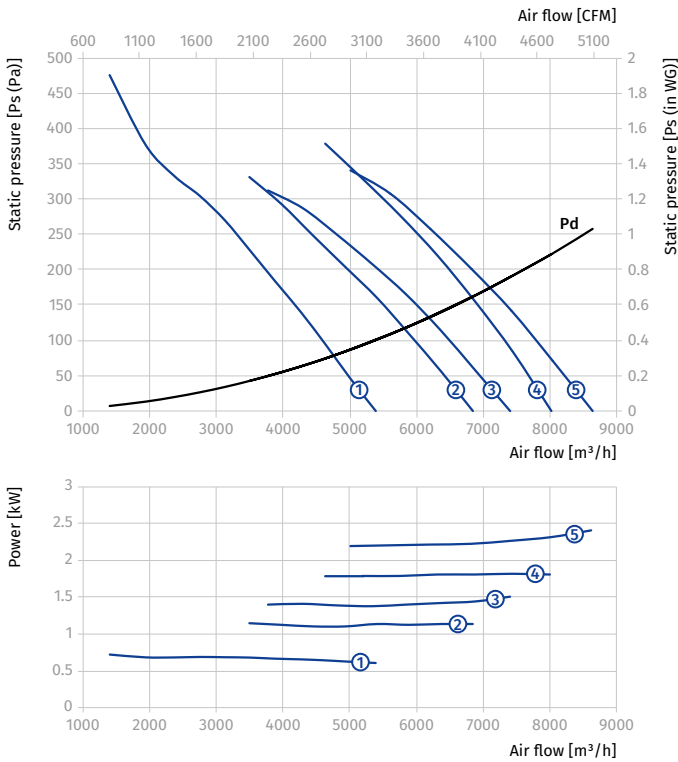

Standard size: 400
 Number of poles: 4
 Fire resistance rating: 400/2

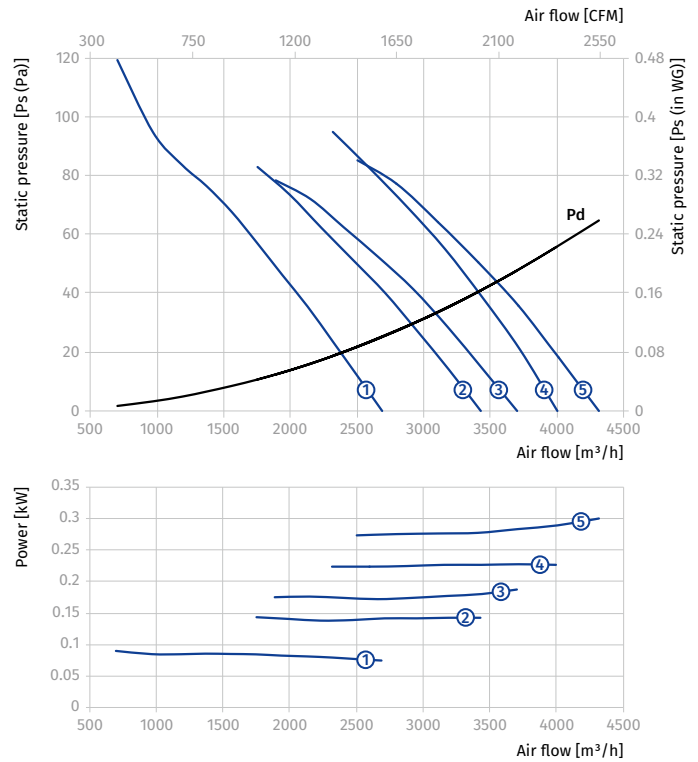

AXIS-FP 450...400/2

Size	Number of poles	Voltage [V/50 Hz]	Fan model	Installed motor power Ny [kW]	RPM [min ⁻¹]	Number of blades	Blade setting angle [°]	Weight [kg]	Length L [mm]	Curve number on graph
Axis-FP 450-2D...400/2										
450	2	3~400	Axis-FP 450-2D/0.75-4/20/AL	0.75	2880	4	20	27.3	400	①
			Axis-FP 450-2D/1.1-4/25/AL	1.1	2880	4	25	31.3	400	②
			Axis-FP 450-2D/1.5-4/30/AL	1.5	2880	4	30	32.8	400	③
			Axis-FP 450-2D/2.2-6/35/AL	2.2	2880	6	35	35.4	400	④
			Axis-FP 450-2D/3-12/35/AL	3	2880	12	35	43.3	400	⑤
			Axis-FP 450-2D/4-12/40/AL	4	2880	12	40	55.2	500	⑥
Axis-FP 450-4D...400/2										
450	4	3~400	Axis-FP 450-4D/0.55-6/25/AL	0.55	1440	6	25	27.6	400	①
			Axis-FP 450-4D/0.55-6/30/AL	0.55	1440	6	30	27.6	400	②
			Axis-FP 450-4D/0.55-6/35/AL	0.55	1440	6	35	27.6	400	③
			Axis-FP 450-4D/0.55-6/40/AL	0.55	1440	6	40	27.6	400	④
			Axis-FP 450-4D/0.55-9/40/AL	0.55	1440	9	40	28.2	400	⑤
			Axis-FP 450-4D/0.55-9/45/AL	0.55	1440	9	45	28.2	400	⑥

Standard size: 450
Number of poles: 2
Fire resistance rating: 400/2

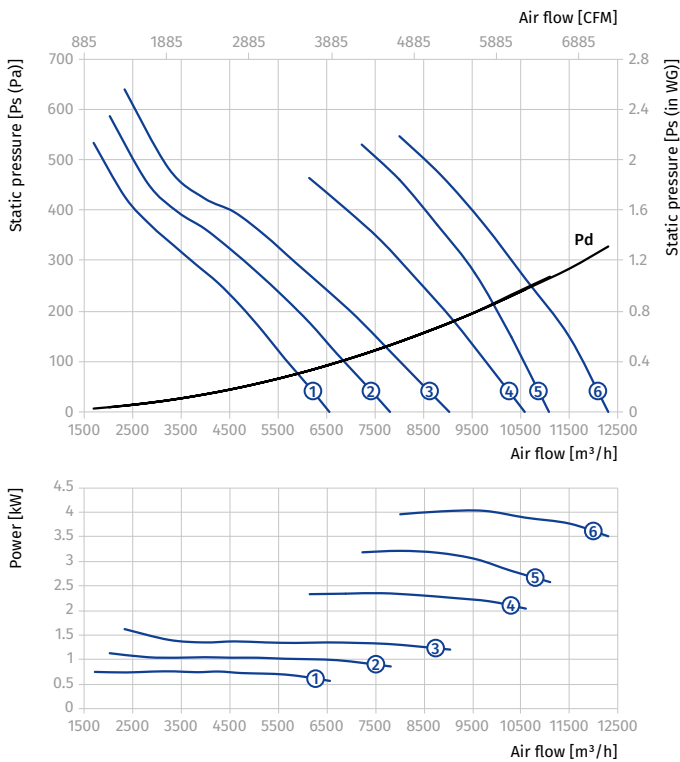

Standard size: 450
Number of poles: 4
Fire resistance rating: 400/2

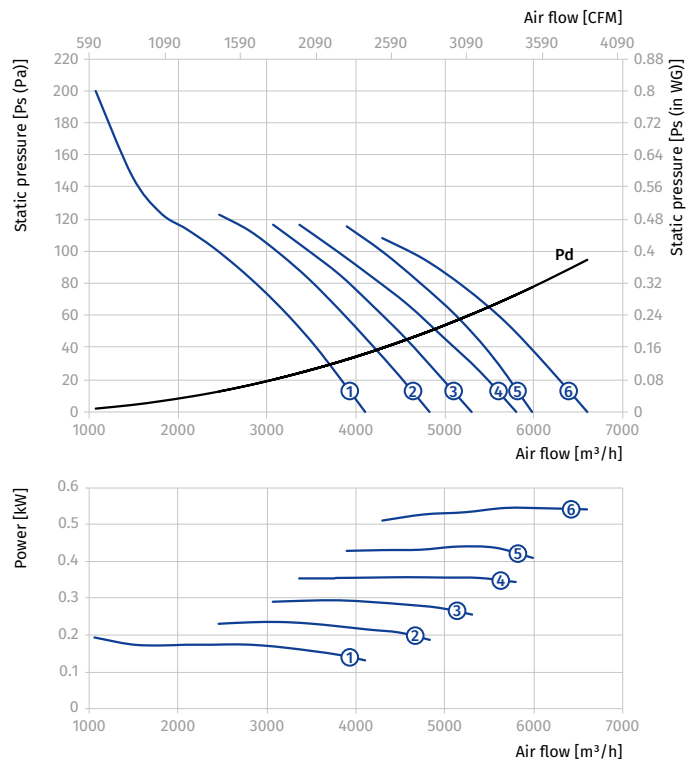

AXIS-FP 450...400/2

Size	Number of poles	Voltage [V/50 Hz]	Fan model	Installed motor power N_y [kW]	RPM [min^{-1}]	Number of blades	Blade setting angle [°]	Weight [kg]	Length L [mm]	Curve number on graph
Axis-FP 450-2/4D...400/2										
450	2/4	3~400	Axis-FP 450-2/4D/0.8/0.2-4/20/AL	0.8/0.2	2880/1440	4	20	31.8	400	①
			Axis-FP 450-2/4D/1.1/0.25-4/25/AL	1.1/0.25	2880/1440	4	25	32.8	400	②
			Axis-FP 450-2/4D/1.5/0.37-4/30/AL	1.5/0.37	2880/1440	4	30	38.3	400	③
			Axis-FP 450-2/4D/2.2/0.5-6/35/AL	2.2/0.5	2880/1440	6	35	40.7	400	④
			Axis-FP 450-2/4D/3.1/0.8-12/35/AL	3.1/0.8	2880/1440	12	35	54.2	500	⑤
			Axis-FP 450-2/4D/4.4/1.1-12/40/AL	4.4/1.1	2880/1440	12	40	66.2	500	⑥

Standard size: 450
 Number of poles: 2
 Fire resistance rating: 400/2

Standard size: 450
 Number of poles: 4
 Fire resistance rating: 400/2

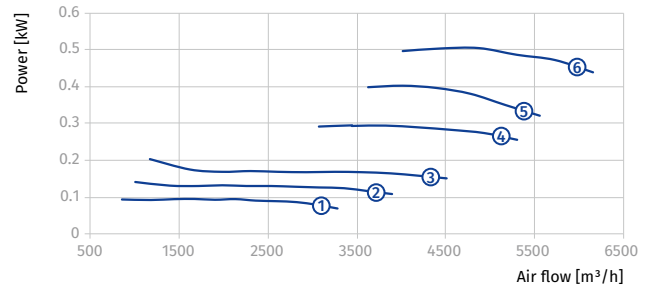
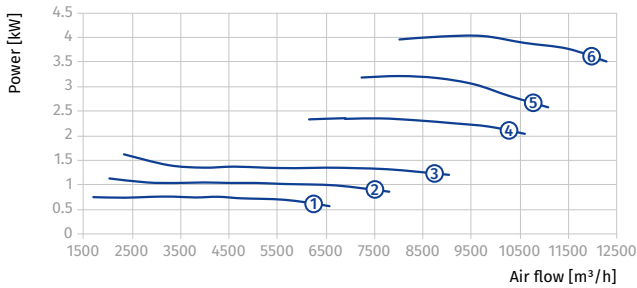
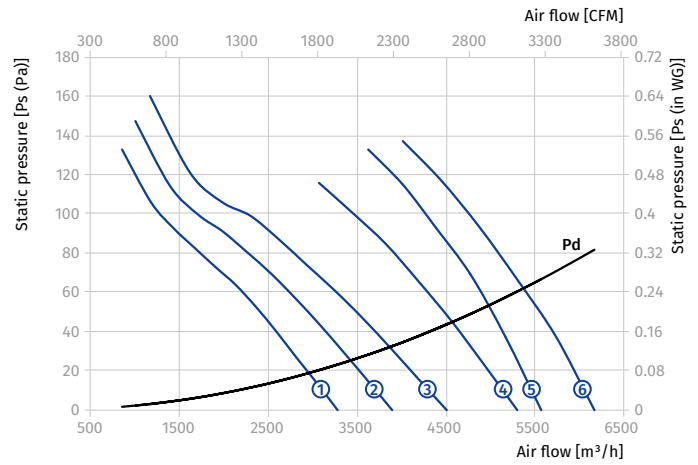
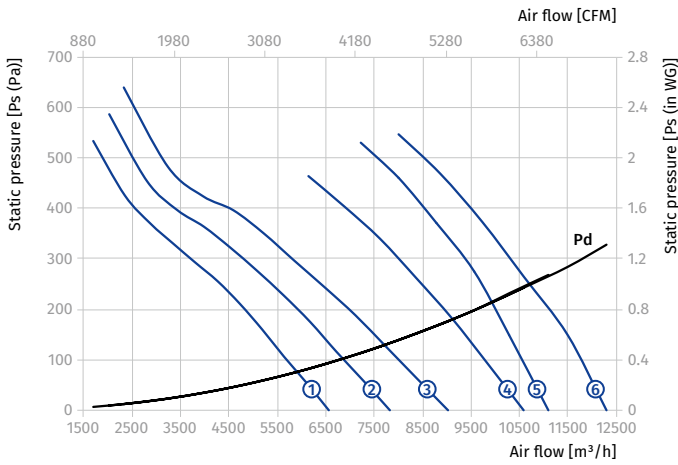

AXIAL SMOKE EXTRACTION FANS

AXIS-FP 500...400/2

Size	Number of poles	Voltage [V/50 Hz]	Fan model	Installed motor power Ny [kW]	RPM [min ⁻¹]	Number of blades	Blade setting angle [°]	Weight [kg]	Length L [mm]	Curve number on graph
Axis-FP 500-2D...400/2										
500	2	3~400	Axis-FP 500-2D/1.5-6/20/AL	1.5	2880	6	20	35.0	400	①
			Axis-FP 500-2D/2.2-6/25/AL	2.2	2880	6	25	37.5	400	②
			Axis-FP 500-2D/3-6/30/AL	3	2880	6	30	44.0	400	③
			Axis-FP 500-2D/4-6/35/AL	4	2880	6	35	56.5	500	④
			Axis-FP 500-2D/5.5-9/40/AL	5.5	2880	9	40	65.0	500	⑤
Axis-FP 500-4D...400/2										
500	4	3~400	Axis-FP 500-4D/0.55-6/20/AL	0.55	1440	6	20	29.5	400	①
			Axis-FP 500-4D/0.55-6/25/AL	0.55	1440	6	25	29.5	400	②
			Axis-FP 500-4D/0.55-6/30/AL	0.55	1440	6	30	29.5	400	③
			Axis-FP 500-4D/0.55-6/35/AL	0.55	1440	6	35	29.5	400	④
			Axis-FP 500-4D/0.55-6/40/AL	0.55	1440	6	40	29.5	400	⑤
			Axis-FP 500-4D/0.75-9/40/AL	0.75	1440	9	40	31.0	400	⑥

Standard size: 500
Number of poles: 2
Fire resistance rating: 400/2

Standard size: 500
Number of poles: 4
Fire resistance rating: 400/2

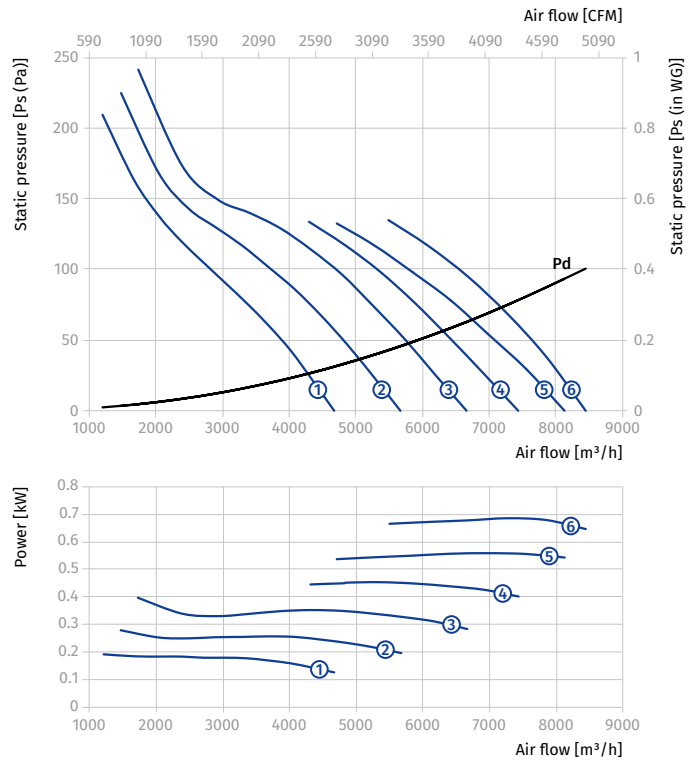
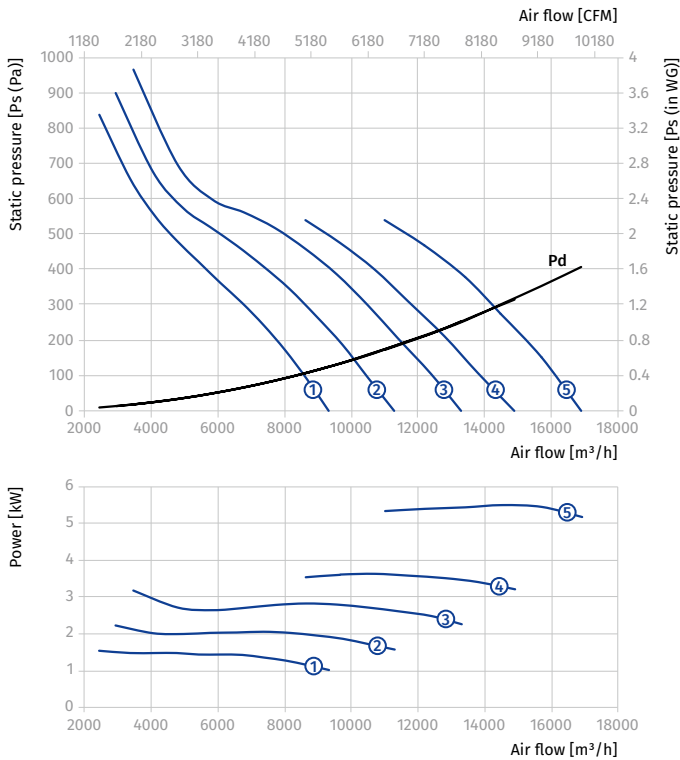

AXIS-FP 500...400/2

Size	Number of poles	Voltage [V/50 Hz]	Fan model	Installed motor power N_y [kW]	RPM [min^{-1}]	Number of blades	Blade setting angle [°]	Weight [kg]	Length L [mm]	Curve number on graph
Axis-FP 500-2/4D...400/2										
500	2/4	3~400	Axis-FP 500-2/4D/1.5/0.37-6/20/AL	1.5/0.37	2880/1440	6	20	40.5	400	①
			Axis-FP 500-2/4D/2.2/0.5-6/25/AL	2.2/0.5	2880/1440	6	25	42.5	400	②
			Axis-FP 500-2/4D/3.1/0.8-6/30/AL	3.1/0.8	2880/1440	6	30	55.5	500	③
			Axis-FP 500-2/4D/4.4/1.1-6/35/AL	4.4/1.1	2880/1440	6	35	67.5	500	④
			Axis-FP 500-2/4D/6.0/1.5-9/40/AL	6.0/1.5	2880/1440	9	40	87	550	⑤

Standard size: 500
 Number of poles: 2
 Fire resistance rating: 400/2

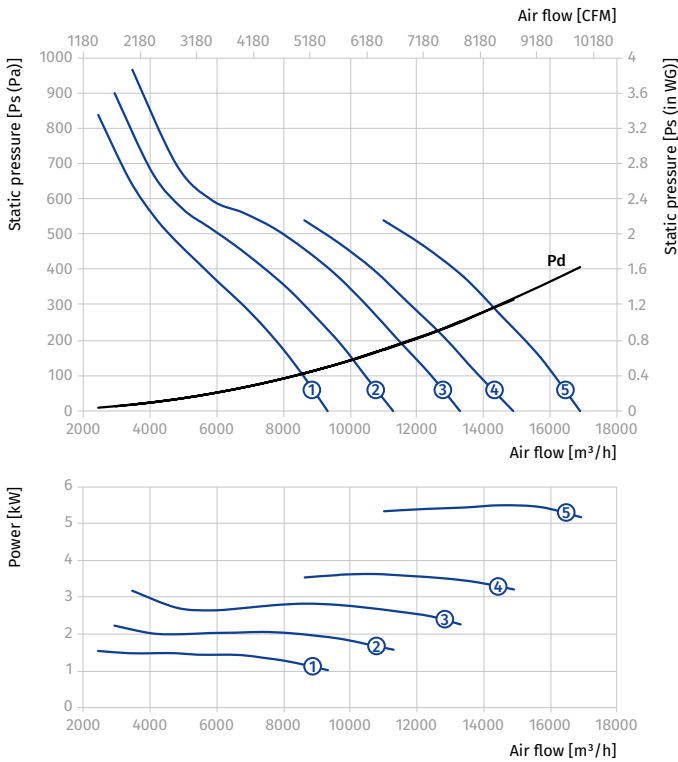

Standard size: 500
 Number of poles: 4
 Fire resistance rating: 400/2

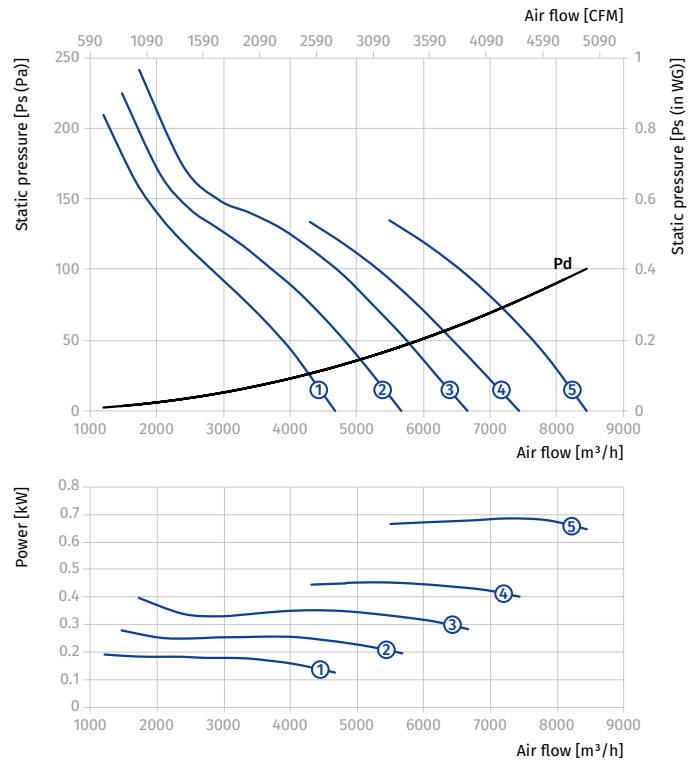

AXIAL SMOKE EXTRACTION FANS

AXIS-FP 560...400/2

Size	Number of poles	Voltage [V/50 Hz]	Fan model	Installed motor power Ny [kW]	RPM [min ⁻¹]	Number of blades	Blade setting angle [°]	Weight [kg]	Length L [mm]	Curve number on graph
Axis-FP 560-2D...400/2										
560	2	3~400	Axis-FP 560-2D/2.2-6/20/AL	2.2	2880	6	20	39.5	400	①
			Axis-FP 560-2D/3-6/25/AL	3	2880	6	25	46	400	②
			Axis-FP 560-2D/4-6/30/AL	4	2880	6	30	58.5	500	③
			Axis-FP 560-2D/5.5-6/35/AL	5.5	2880	6	35	66.5	500	④
			Axis-FP 560-2D/7.5-12/35/AL	7.5	2880	12	35	70	500	⑤
Axis-FP 560-4D...400/2										
560	4	3~400	Axis-FP 560-4D/0.55-6/20/AL	0.55	1440	6	20	31.5	400	①
			Axis-FP 560-4D/0.55-6/25/AL	0.55	1440	6	25	31.5	400	②
			Axis-FP 560-4D/0.55-6/30/AL	0.55	1440	6	30	31.5	400	③
			Axis-FP 560-4D/0.75-6/35/AL	0.75	1440	6	35	32.5	400	④
			Axis-FP 560-4D/1.1-9/40/AL	1.1	1440	9	40	37.5	400	⑤
			Axis-FP 560-4D/1.5-12/45/AL	1.5	1440	12	45	41	400	⑥

Standard size: 560
Number of poles: 2
Fire resistance rating: 400/2

Standard size: 560
Number of poles: 4
Fire resistance rating: 400/2

AXIAL SMOKE EXTRACTION FANS

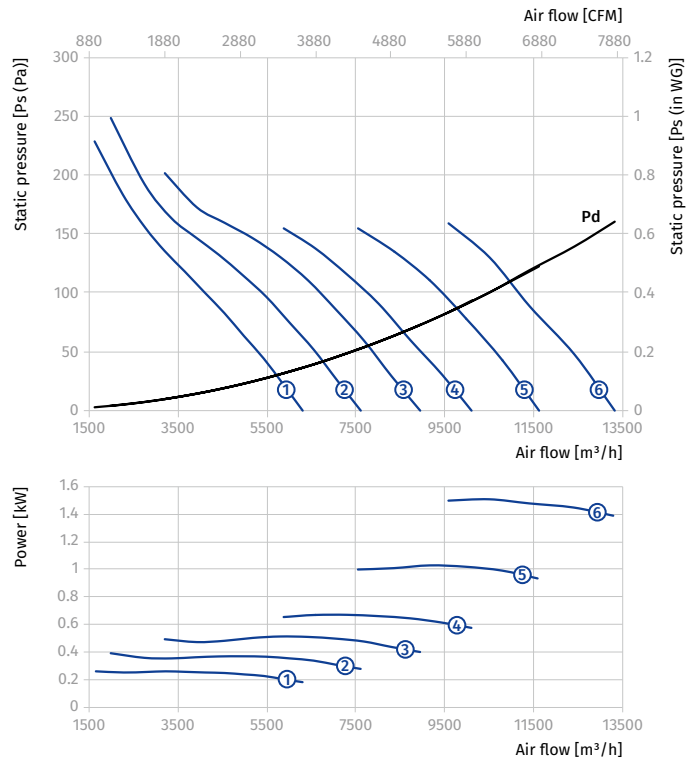
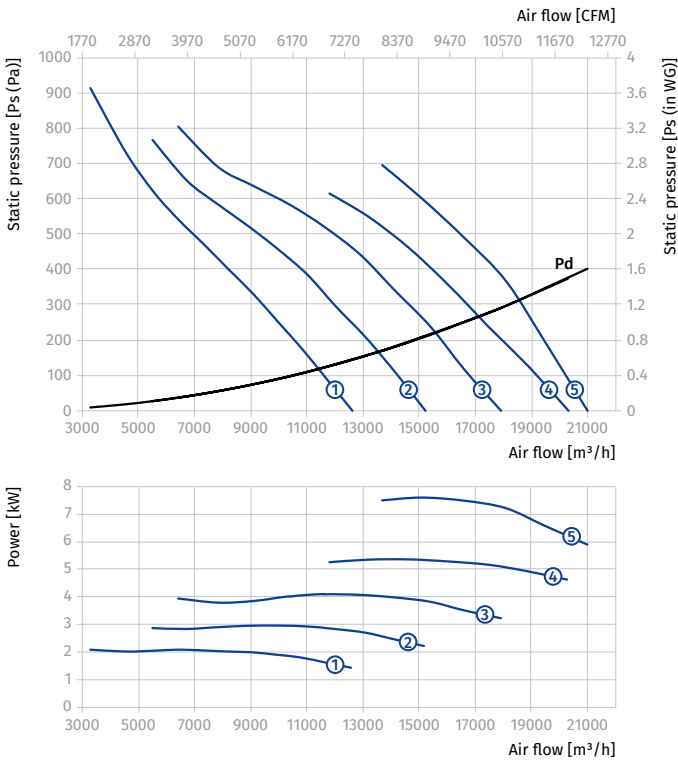

AXIS-FP 560...400/2

Size	Number of poles	Voltage [V/50 Hz]	Fan model	Installed motor power N_y [kW]	RPM [min ⁻¹]	Number of blades	Blade setting angle [°]	Weight [kg]	Length L [mm]	Curve number on graph
Axis-FP 560-2/4D...400/2										
560	2/4	3~400	Axis-FP 560-2/4D/2.2/0.5-6/20/AL	2.2/0.5	2880/1440	6	20	44.5	400	①
			Axis-FP 560-2/4D/3.1/0.8-6/25/AL	3.1/0.8	2880/1440	6	25	57.5	500	②
			Axis-FP 560-2/4D/4.4/1.1-6/30/AL	4.4/1.1	2880/1440	6	30	69.5	500	③
			Axis-FP 560-2/4D/6.0/1.5-6/35/AL	6.0/1.5	2880/1440	6	35	97.5	550	④
			Axis-FP 560-2/4D/8.0/2.0-12/35/AL	8.0/2.0	2880/1440	12	35	108	550	⑤

Standard size: 560
 Number of poles: 2
 Fire resistance rating: 400/2

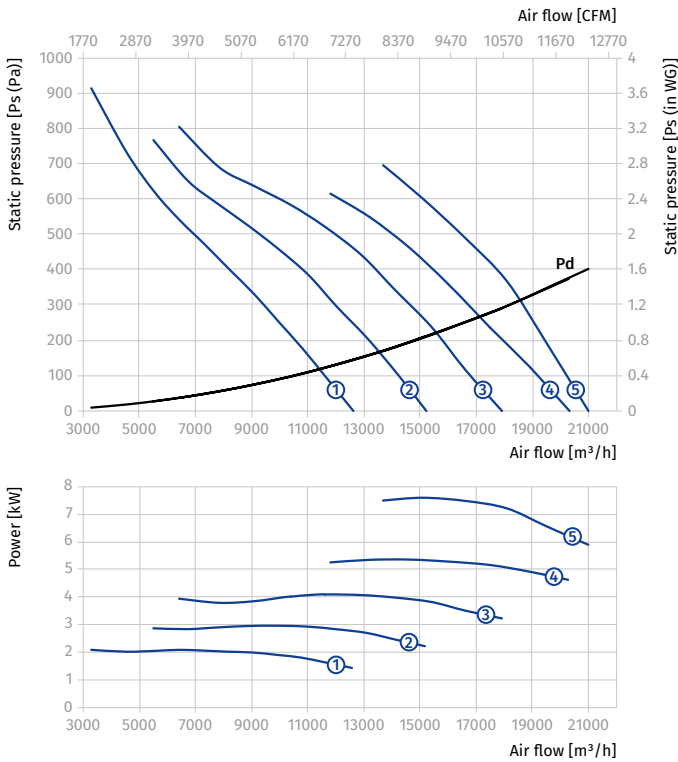

Standard size: 560
 Number of poles: 4
 Fire resistance rating: 400/2

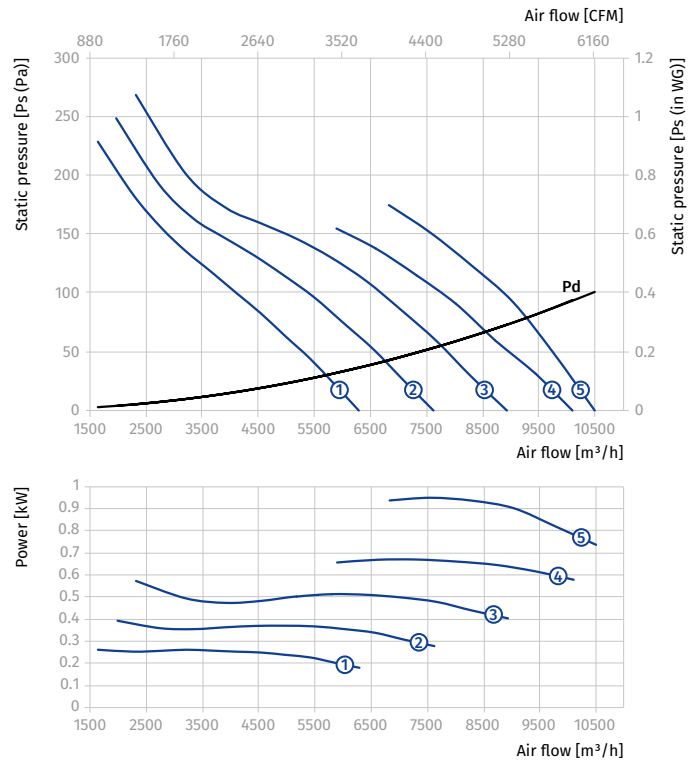

AXIAL SMOKE EXTRACTION FANS

AXIS-FP 630...400/2

Size	Number of poles	Voltage [V/50 Hz]	Fan model	Installed motor power Ny [kW]	RPM [min ⁻¹]	Number of blades	Blade setting angle [°]	Weight [kg]	Length L [mm]	Curve number on graph
Axis-FP 630-2D...400/2										
630	2	3~400	Axis-FP 630-2D/4-9/20/AL	4	2880	9	20	62	500	①
			Axis-FP 630-2D/5.5-9/25/AL	5.5	2880	9	25	70	500	②
			Axis-FP 630-2D/7.5-9/30/AL	7.5	2880	9	30	72	500	③
			Axis-FP 630-2D/11-9/35/AL	11	2880	9	35	118	550	④
			Axis-FP 630-2D/15-9/40/AL	15	2880	9	40	165.5	700	⑤
			Axis-FP 630-2D/18.5-9/45/AL	18.5	2880	9	45	179.5	700	⑥
			Axis-FP 630-2D/18.5-12/45/AL	18.5	2880	12	45	180.5	700	⑦
Axis-FP 630-4D...400/2										
630	4	3~400	Axis-FP 630-4D/0.55-9/20/AL	0.55	1440	9	20	34.5	400	①
			Axis-FP 630-4D/0.75-9/25/AL	0.75	1440	9	25	35.5	400	②
			Axis-FP 630-4D/1.1-9/30/AL	1.1	1440	9	30	39.5	400	③
			Axis-FP 630-4D/1.5-9/35/AL	1.5	1440	9	35	42.5	400	④
			Axis-FP 630-4D/2.2-9/40/AL	2.2	1440	9	40	48.5	400	⑤
			Axis-FP 630-4D/2.2-9/45/AL	2.2	1440	9	45	48.5	400	⑥

Standard size: 630
Number of poles: 2
Fire resistance rating: 400/2

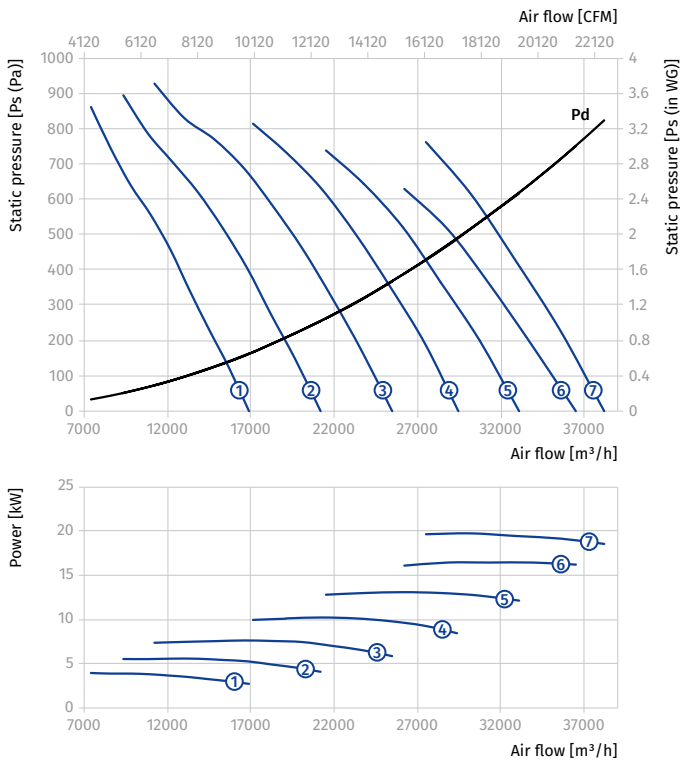

Standard size: 630
Number of poles: 4
Fire resistance rating: 400/2

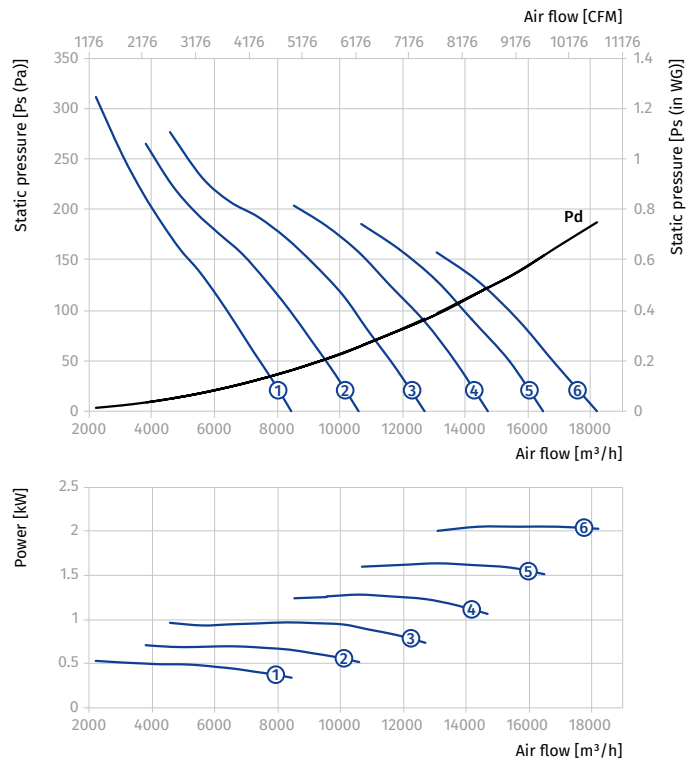

AXIS-FP 630...400/2

Size	Number of poles	Voltage [V/50 Hz]	Fan model	Installed motor power N_y [kW]	RPM [min^{-1}]	Number of blades	Blade setting angle [°]	Weight [kg]	Length L [mm]	Curve number on graph
Axis-FP 630-2/4D...400/2										
630	2/4	3~400	Axis-FP 630-2/4D/4.4/1.1-9/20/AL	4.4/1.1	2880/1440	9	20	73	500	①
			Axis-FP 630-2/4D/6/1.5-9/25/AL	6/1.5	2880/1440	9	25	102.5	550	②
			Axis-FP 630-2/4D/8/2-9/30/AL	8/2	2880/1440	9	30	111.5	550	③
			Axis-FP 630-2/4D/12/3-9/35/AL	12/3	2880/1440	9	35	176	700	④
			Axis-FP 630-2/4D/16/4-9/40/AL	16/4	2880/1440	9	40	193	700	⑤
			Axis-FP 630-2/4D/16/4-9/45/AL	16/4	2880/1440	9	45	193	700	⑥

Standard size: 630
 Number of poles: 2
 Fire resistance rating: 400/2

Standard size: 630
 Number of poles: 4
 Fire resistance rating: 400/2

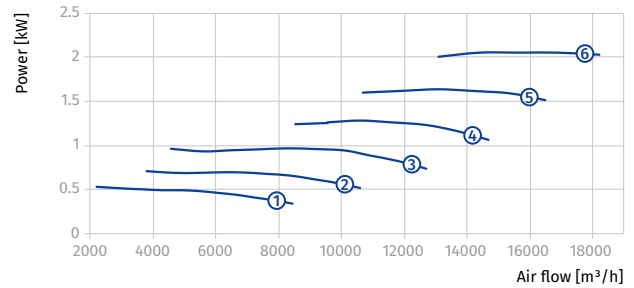
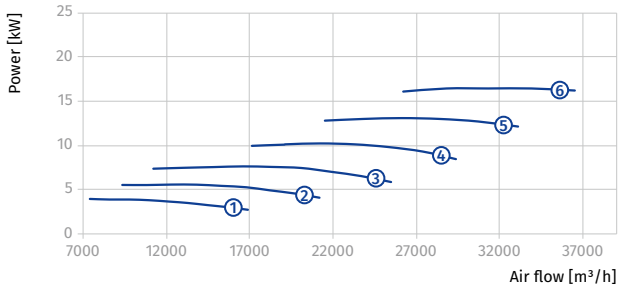
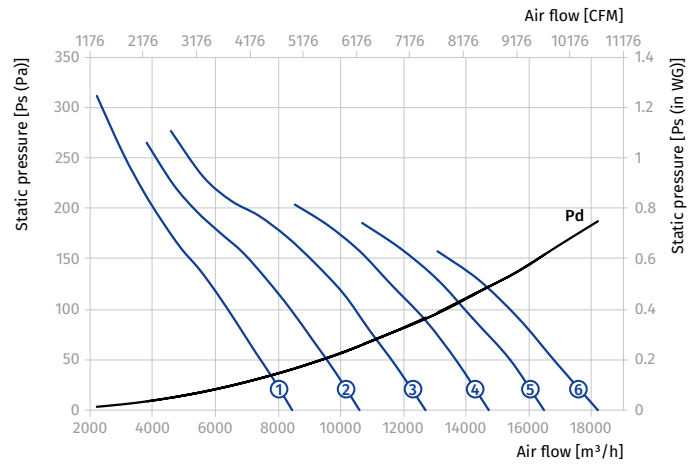
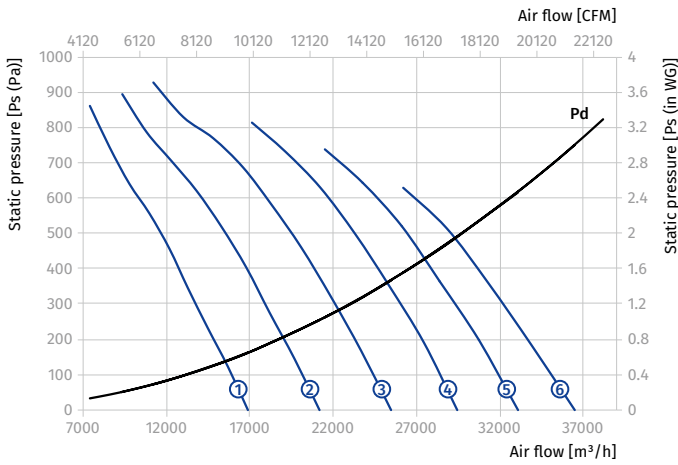

AXIAL SMOKE EXTRACTION FANS

AXIS-FP 630...400/2

Size	Number of poles	Voltage [V/50 Hz]	Fan model	Installed motor power Ny [kW]	RPM [min ⁻¹]	Number of blades	Blade setting angle [°]	Weight [kg]	Length L [mm]	Curve number on graph
Axis-FP 630-4/6D...400/2										
630	4/6	3~400	Axis-FP 630-4/6D/0.55/0.2-9/20/AL	0.55/0.2	1440/960	9	20	37	400	①
			Axis-FP 630-4/6D/0.75/0.25-9/25/AL	0.75/0.25	1440/960	9	25	37	400	②
			Axis-FP 630-4/6D/1.1/0.3-9/30/AL	1.1/0.3	1440/960	9	30	41.5	400	③
			Axis-FP 630-4/6D/1.5/0.37-9/35/AL	1.5/0.37	1440/960	9	35	45.5	400	④
			Axis-FP 630-4/6D/2.2/0.7-9/40/AL	2.2/0.7	1440/960	9	40	57	500	⑤
			Axis-FP 630-4/6D/2.2/0.7-9/45/AL	2.2/0.7	1440/960	9	45	57	500	⑥

Standard size: 630
Number of poles: 4
Fire resistance rating: 400/2

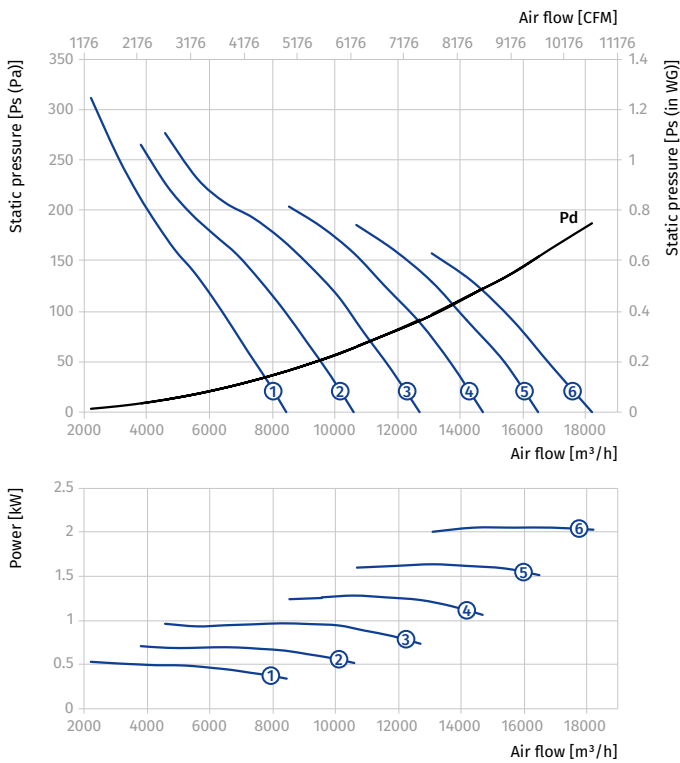

Standard size: 630
Number of poles: 6
Fire resistance rating: 400/2

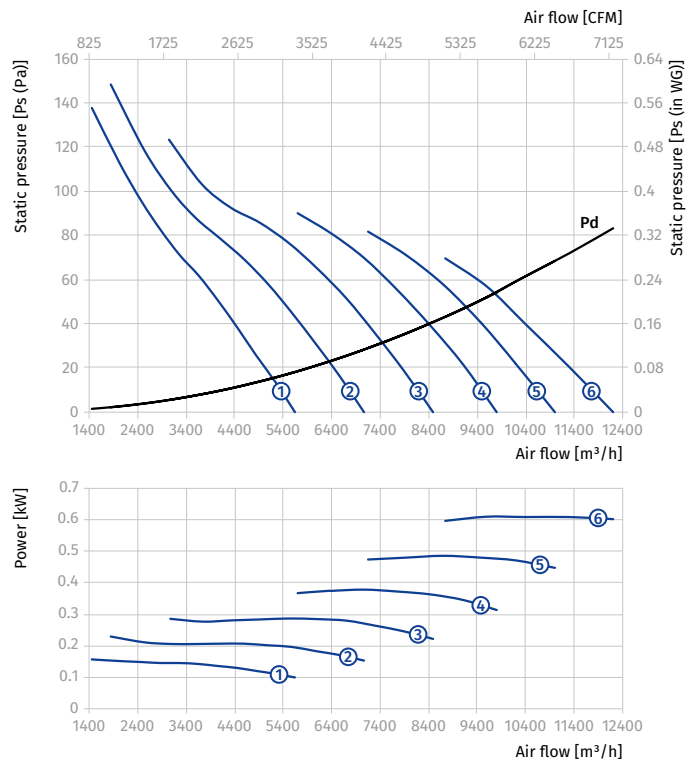

AXIS-FP 630...400/2

Size	Number of poles	Voltage [V/50 Hz]	Fan model	Installed motor power N_y [kW]	RPM [min ⁻¹]	Number of blades	Blade setting angle [°]	Weight [kg]	Length L [mm]	Curve number on graph
Axis-FP 630-4/8D...400/2										
630	4/8	3~400	Axis-FP 630-4/8D/0.6/0.15-9/20/AL	0.6/0.15	1440/720	9	20	39	400	①
			Axis-FP 630-4/8D/0.8/0.2-9/25/AL	0.8/0.2	1440/720	9	25	39	400	②
			Axis-FP 630-4/8D/1.2/0.3-9/30/AL	1.2/0.3	1440/720	9	30	45.5	400	③
			Axis-FP 630-4/8D/1.6/0.4-9/35/AL	1.6/0.4	1440/720	9	35	48.5	400	④
			Axis-FP 630-4/8D/2.2/0.55-9/40/AL	2.2/0.55	1440/720	9	40	60	500	⑤
			Axis-FP 630-4/8D/2.2/0.55-9/45/AL	2.2/0.55	1440/720	9	45	60	500	⑥

Standard size: 630
 Number of poles: 4
 Fire resistance rating: 400/2

Standard size: 630
 Number of poles: 8
 Fire resistance rating: 400/2

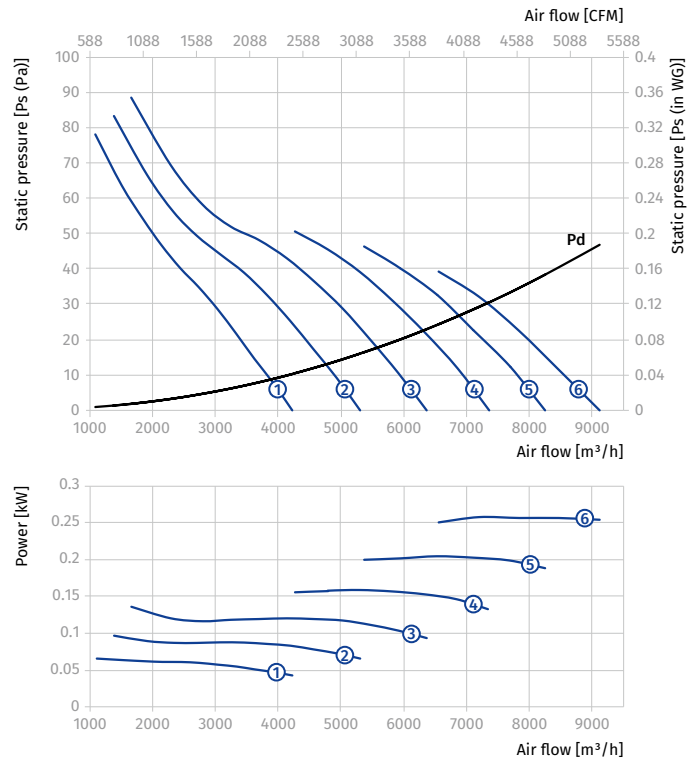
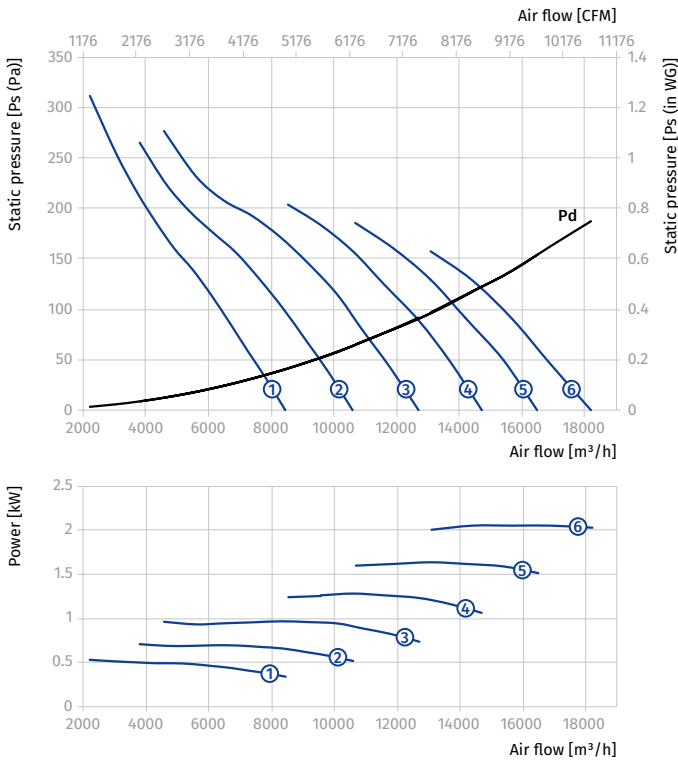

AXIS-FP 710...400/2

Size	Number of poles	Voltage [V/50 Hz]	Fan model	Installed motor power Ny [kW]	RPM [min ⁻¹]	Number of blades	Blade setting angle [°]	Weight [kg]	Length L [mm]	Curve number on graph
Axis-FP 710-4D...400/2										
710	4	3~400	Axis-FP 710-4D/1.1-5/20/AL	1.1	1440	5	20	57.5	400	①
			Axis-FP 710-4D/1.5-5/25/AL	1.5	1440	5	25	61	450	②
			Axis-FP 710-4D/2.2-5/30/AL	2.2	1440	5	30	67	450	③
			Axis-FP 710-4D/3-5/35/AL	3	1440	5	35	81	550	④
			Axis-FP 710-4D/3-5/40/AL	3	1440	5	40	81	550	⑤
			Axis-FP 710-4D/0.75-9/20/AL	0.75	1440	9	20	47	400	⑥
			Axis-FP 710-4D/1.1-9/25/AL	1.1	1440	9	25	51.5	400	⑦
			Axis-FP 710-4D/1.5-9/30/AL	1.5	1440	9	30	55	400	⑧
			Axis-FP 710-4D/2.2-9/35/AL	2.2	1440	9	35	61	400	⑨
			Axis-FP 710-4D/3-9/40/AL	3	1440	9	40	75	500	⑩
			Axis-FP 710-4D/3-9/45/AL	3	1440	9	45	75	500	⑪

Standard size: 710
Number of poles: 4
Fire resistance rating: 400/2

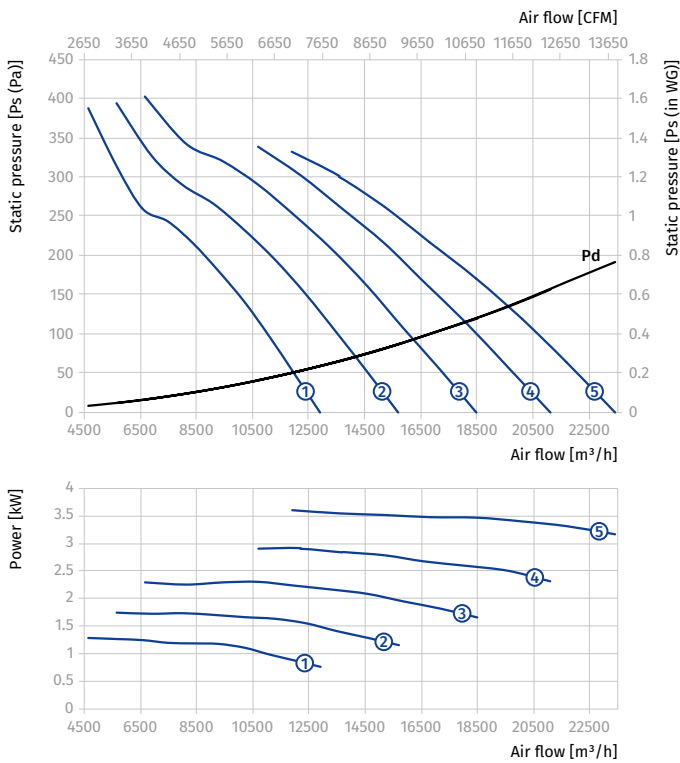

Standard size: 710
Number of poles: 4
Fire resistance rating: 400/2

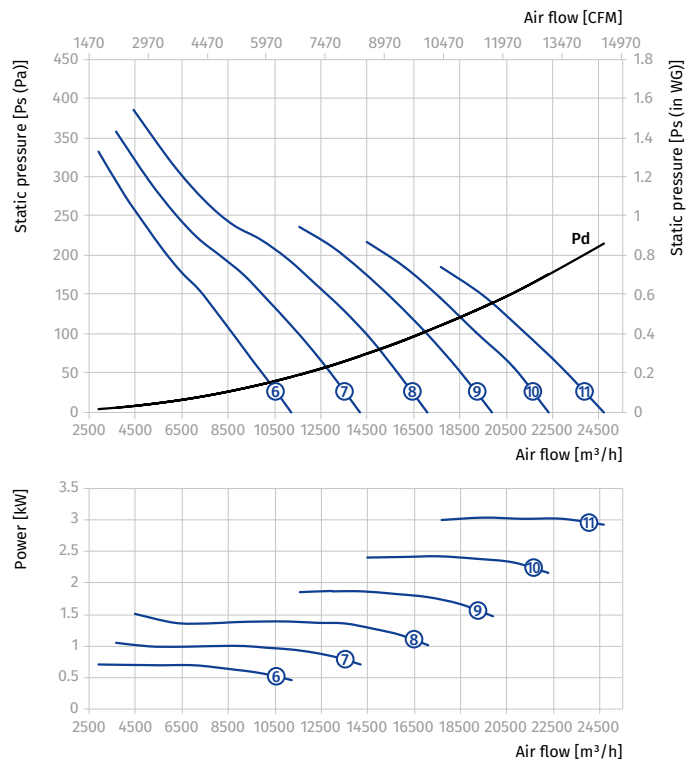

AXIS-FP 710...400/2

Size	Number of poles	Voltage [V/50 Hz]	Fan model	Installed motor power N_y [kW]	RPM [min^{-1}]	Number of blades	Blade setting angle [°]	Weight [kg]	Length L [mm]	Curve number on graph
Axis-FP 710-6D...400/2										
710	6	3~400	Axis-FP 710-6D/0.37-5/20/AL	0.37	960	5	20	55	400	①
			Axis-FP 710-6D/0.55-5/25/AL	0.55	960	5	25	58.5	400	②
			Axis-FP 710-6D/0.75-5/30/AL	0.75	960	5	30	62	450	③
			Axis-FP 710-6D/0.75-5/35/AL	0.75	960	5	35	62	450	④
			Axis-FP 710-6D/1.1-5/40/AL	1.1	960	5	40	66	450	⑤
			Axis-FP 710-6D/0.37-9/20/AL	0.37	960	9	20	49	400	⑥
			Axis-FP 710-6D/0.37-9/25/AL	0.37	960	9	25	49	400	⑦
			Axis-FP 710-6D/0.55-9/30/AL	0.55	960	9	30	52.5	400	⑧
			Axis-FP 710-6D/0.55-9/35/AL	0.55	960	9	35	52.5	400	⑨
			Axis-FP 710-6D/0.75-9/40/AL	0.75	960	9	40	56	400	⑩
			Axis-FP 710-6D/1.1-9/45/AL	1.1	960	9	45	60	400	⑪

Standard size: 710
 Number of poles: 6
 Fire resistance rating: 400/2

Standard size: 710
 Number of poles: 6
 Fire resistance rating: 400/2

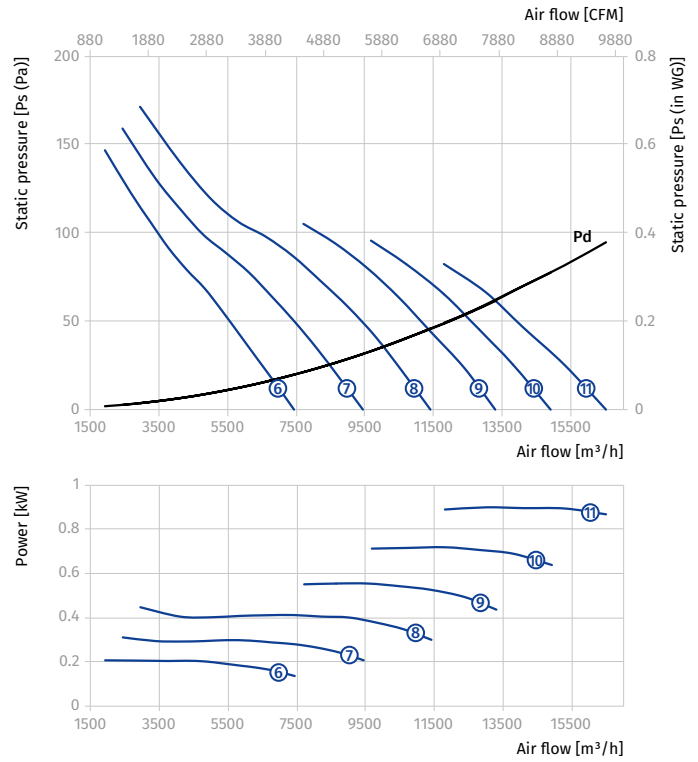
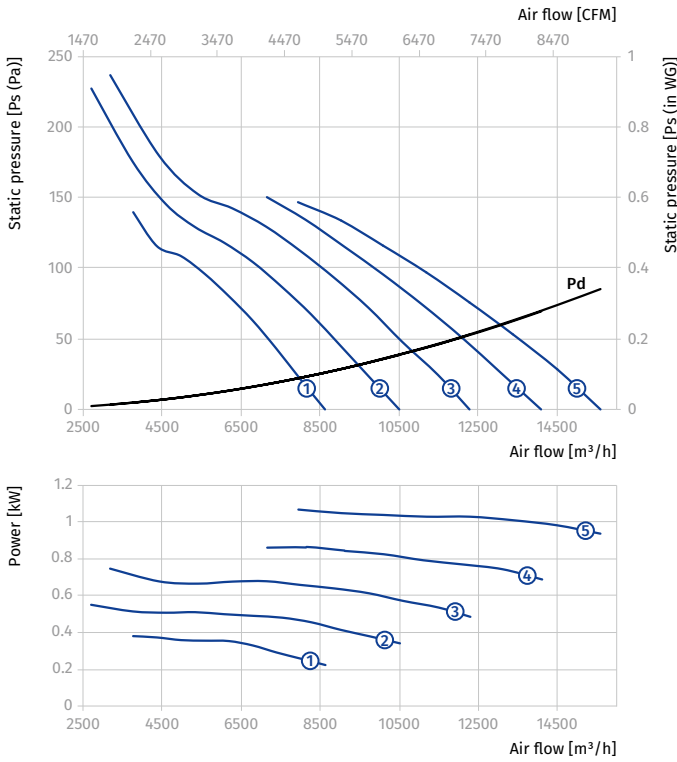

AXIAL SMOKE EXTRACTION FANS

AXIS-FP 710...400/2

Size	Number of poles	Voltage [V/50 Hz]	Fan model	Installed motor power Ny [kW]	RPM [min ⁻¹]	Number of blades	Blade setting angle [°]	Weight [kg]	Length L [mm]	Curve number on graph
Axis-FP 710-4/6D...400/2										
710	4/6	3~400	Axis-FP 710-4/6D/1.1/0.3-5/20/AL	1.1/0.3	1440/960	5	20	60	450	①
			Axis-FP 710-4/6D/1.5/0.37-5/25/AL	1.5/0.37	1440/960	5	25	64	450	②
			Axis-FP 710-4/6D/2.2/0.7-5/30/AL	2.2/0.7	1440/960	5	30	77.5	550	③
			Axis-FP 710-4/6D/3/1-5/35/AL	3/1	1440/960	5	35	86.5	550	④
			Axis-FP 710-4/6D/3/1-5/40/AL	3/1	1440/960	5	40	86.5	550	⑤

Standard size: 710
Number of poles: 4
Fire resistance rating: 400/2

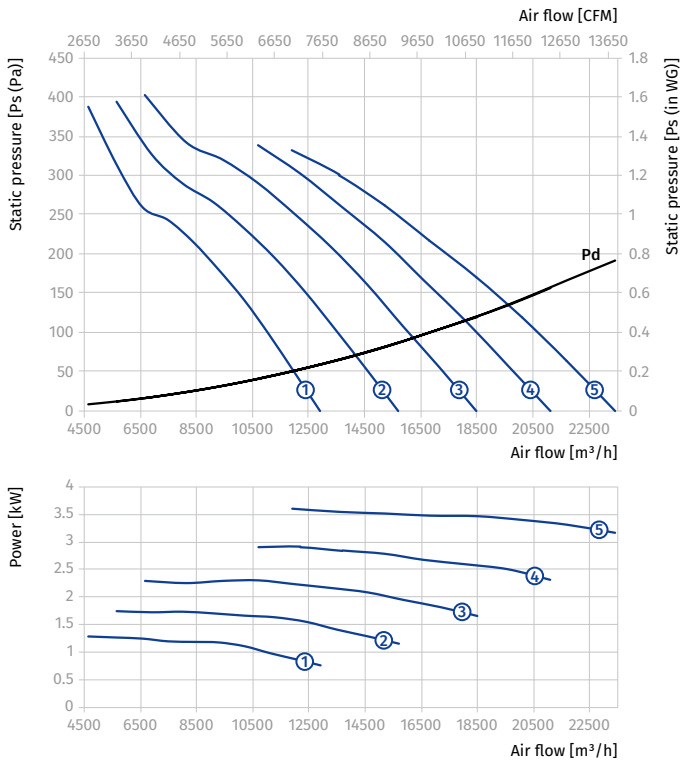

Standard size: 710
Number of poles: 6
Fire resistance rating: 400/2

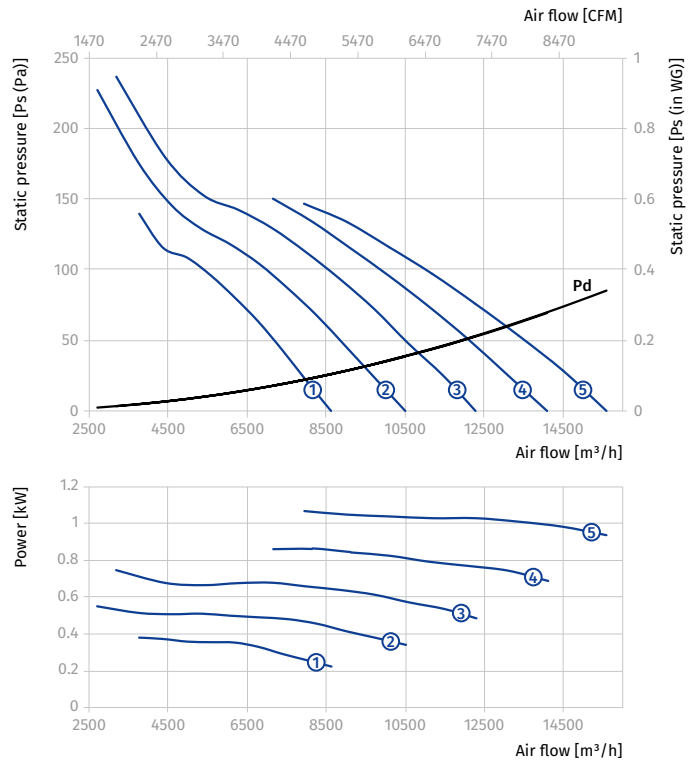

AXIS-FP 710...400/2

Size	Number of poles	Voltage [V/50 Hz]	Fan model	Installed motor power N_y [kW]	RPM [min ⁻¹]	Number of blades	Blade setting angle [°]	Weight [kg]	Length L [mm]	Curve number on graph
Axis-FP 710-4/6D...400/2										
710	4/6	3~400	Axis-FP 710-4/6D/0.75/0.25-9/20/AL	0.75/0.25	1440/960	9	20	49	400	①
			Axis-FP 710-4/6D/1.1/0.3-9/25/AL	1.1/0.3	1440/960	9	25	54	400	②
			Axis-FP 710-4/6D/1.5/0.37-9/30/AL	1.5/0.37	1440/960	9	30	58	400	③
			Axis-FP 710-4/6D/2.2/0.7-9/35/AL	2.2/0.7	1440/960	9	35	71.5	500	④
			Axis-FP 710-4/6D/3/1-9/40/AL	3/1	1440/960	9	40	80.5	500	⑤
			Axis-FP 710-4/6D/3/1-9/45/AL	3/1	1440/960	9	45	80.5	500	⑥

Standard size: 710
 Number of poles: 4
 Fire resistance rating: 400/2

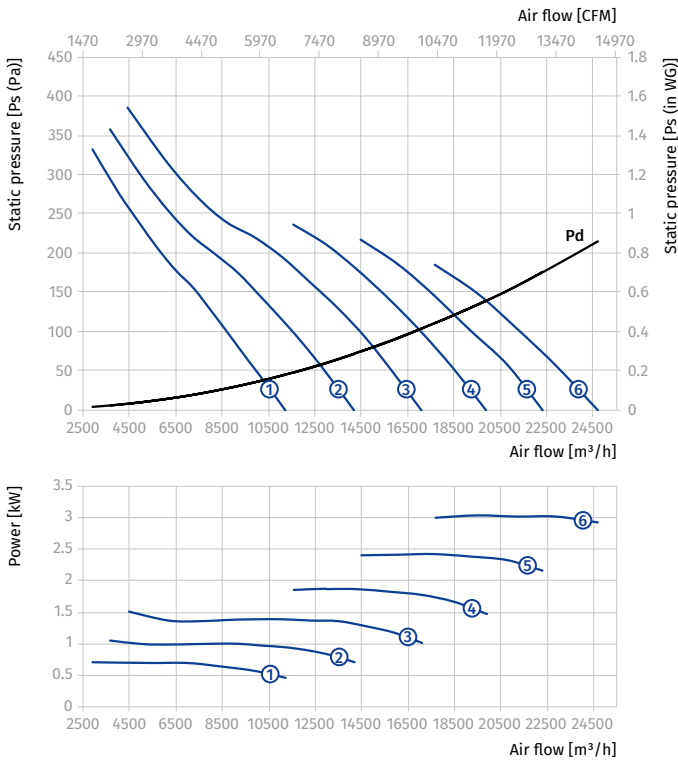

Standard size: 710
 Number of poles: 6
 Fire resistance rating: 400/2

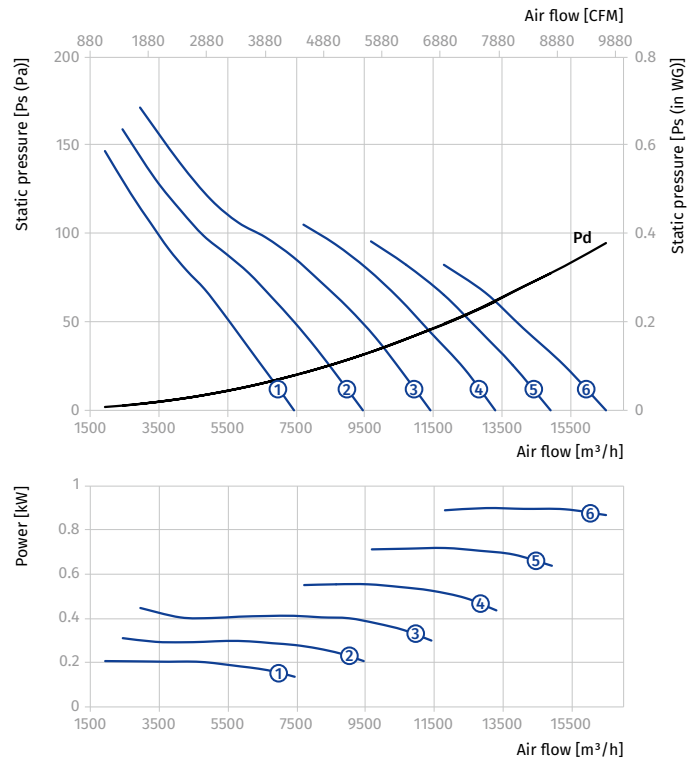

AXIAL SMOKE EXTRACTION FANS

AXIS-FP 710...400/2

Size	Number of poles	Voltage [V/50 Hz]	Fan model	Installed motor power Ny [kW]	RPM [min ⁻¹]	Number of blades	Blade setting angle [°]	Weight [kg]	Length L [mm]	Curve number on graph
Axis-FP 710-4/8D...400/2										
710	4/8	3~400	Axis-FP 710-4/8D/1.2/0.3-5/20/AL	1.2/0.3	1440/720	5	20	64	450	①
			Axis-FP 710-4/8D/1.6/0.4-5/25/AL	1.6/0.4	1440/720	5	25	67	450	②
			Axis-FP 710-4/8D/2.2/0.55-5/30/AL	2.2/0.55	1440/720	5	30	80.5	550	③
			Axis-FP 710-4/8D/2.8/0.7-5/35/AL	2.8/0.7	1440/720	5	35	83.5	550	④
			Axis-FP 710-4/8D/3.8/1-5/40/AL	3.8/1	1440/720	5	40	93.5	550	⑤

Standard size: 710
Number of poles: 4
Fire resistance rating: 400/2

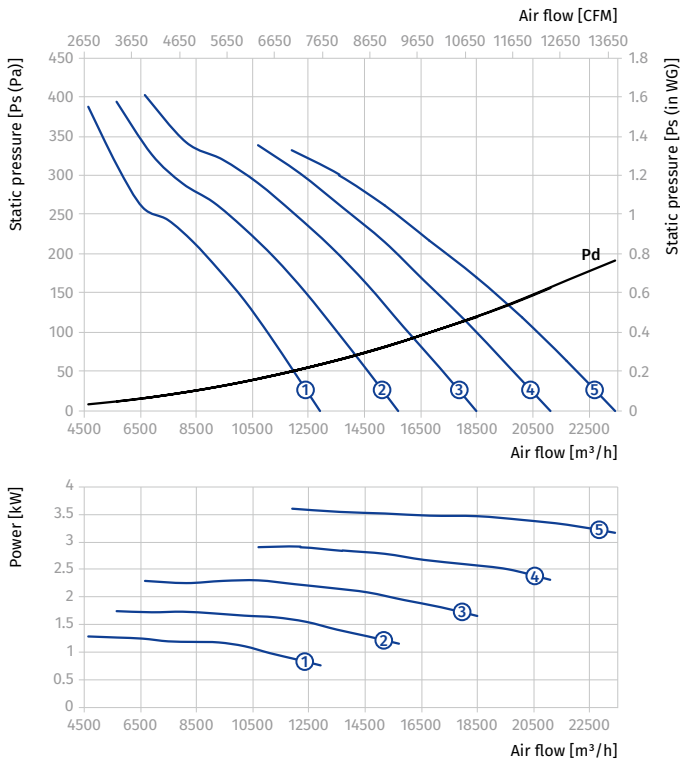

Standard size: 710
Number of poles: 8
Fire resistance rating: 400/2

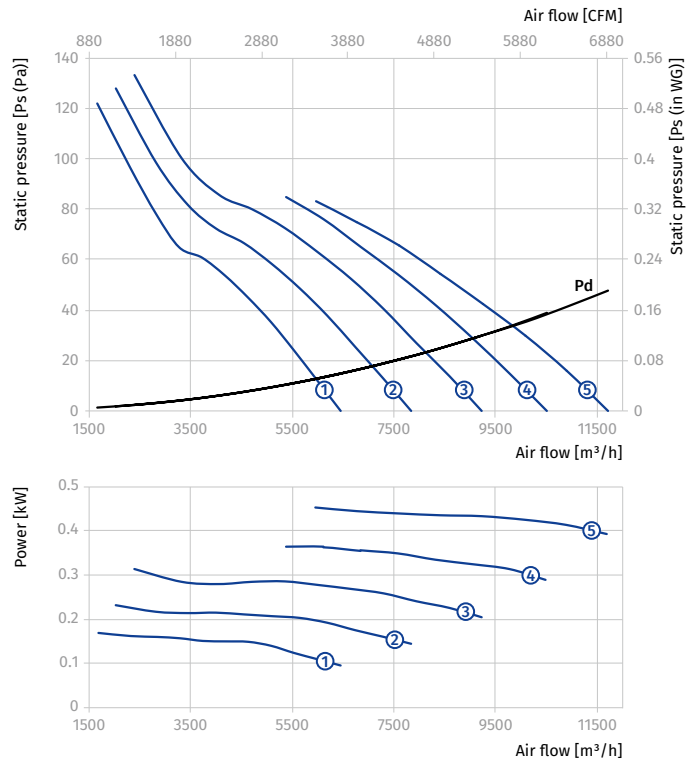

AXIS-FP 710...400/2

Size	Number of poles	Voltage [V/50 Hz]	Fan model	Installed motor power N_y [kW]	RPM [min^{-1}]	Number of blades	Blade setting angle [°]	Weight [kg]	Length L [mm]	Curve number on graph
Axis-FP 710-4/8D...400/2										
710	4/8	3~400	Axis-FP 710-4/8D/0.8/0.2-9/20/AL	0.8/0.2	1440/720	9	20	52	400	①
			Axis-FP 710-4/8D/1.2/0.3-9/25/AL	1.2/0.3	1440/720	9	25	58	400	②
			Axis-FP 710-4/8D/1.6/0.4-9/30/AL	1.6/0.4	1440/720	9	30	61	400	③
			Axis-FP 710-4/8D/2.2/0.55-9/35/AL	2.2/0.55	1440/720	9	35	74.5	500	④
			Axis-FP 710-4/8D/2.8/0.7-9/40/AL	2.8/0.7	1440/720	9	40	77.5	500	⑤
			Axis-FP 710-4/8D/3.8/1-9/45/AL	3.8/1	1440/720	9	45	87.5	500	⑥

Standard size: 710
 Number of poles: 4
 Fire resistance rating: 400/2

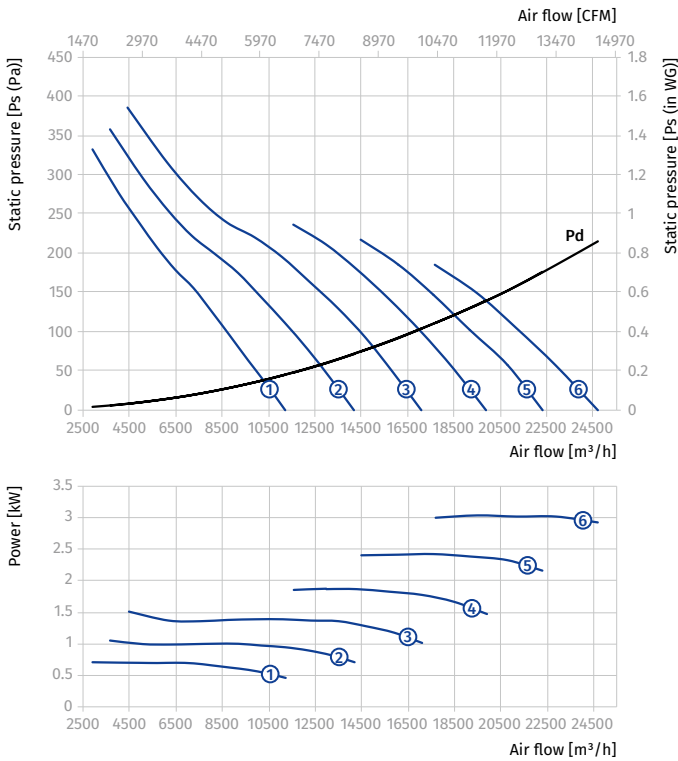

Standard size: 710
 Number of poles: 8
 Fire resistance rating: 400/2

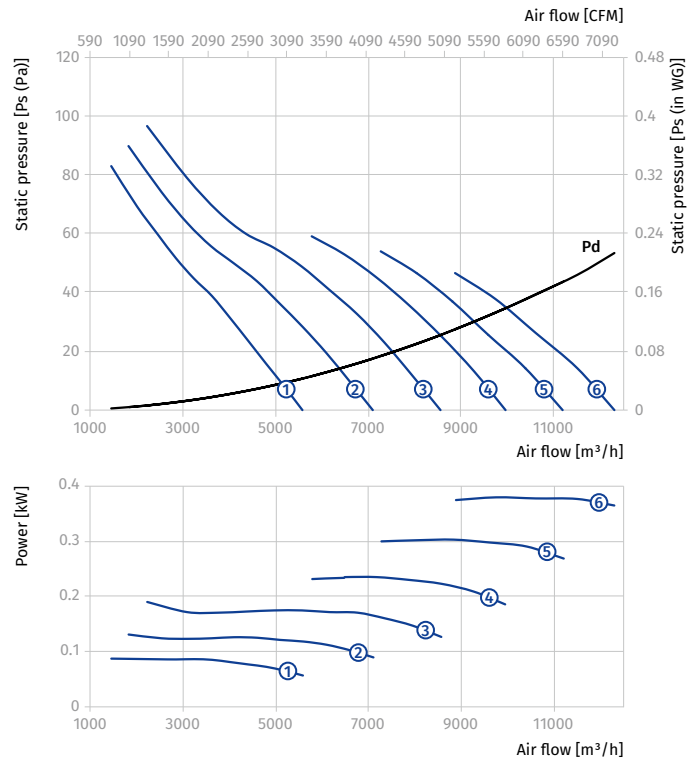

AXIAL SMOKE EXTRACTION FANS

AXIS-FP 800...400/2

Size	Number of poles	Voltage [V/50 Hz]	Fan model	Installed motor power Ny [kW]	RPM [min ⁻¹]	Number of blades	Blade setting angle [°]	Weight [kg]	Length L [mm]	Curve number on graph
Axis-FP 800-4D...400/2										
800	4	3~400	Axis-FP 800-4D/1.5-5/20/AL	1.5	1440	5	20	70.5	450	①
			Axis-FP 800-4D/2.2-5/25/AL	2.2	1440	5	25	76.5	450	②
			Axis-FP 800-4D/3-5/30/AL	3	1440	5	30	91.5	550	③
			Axis-FP 800-4D/4-5/35/AL	4	1440	5	35	96.5	550	④
			Axis-FP 800-4D/5.5-5/40/AL	5.5	1440	5	40	115.5	600	⑤
			Axis-FP 800-4D/1.1-9/20/AL	1.1	1440	9	20	55.5	400	⑥
			Axis-FP 800-4D/1.5-9/25/AL	1.5	1440	9	25	59	400	⑦
			Axis-FP 800-4D/2.2-9/30/AL	2.2	1440	9	30	65	400	⑧
			Axis-FP 800-4D/3-9/35/AL	3	1440	9	35	79.5	500	⑨
			Axis-FP 800-4D/4-9/40/AL	4	1440	9	40	84.5	500	⑩
			Axis-FP 800-4D/5.5-9/45/AL	5.5	1440	9	45	104	550	⑪

Standard size: **800**
Number of poles: **4**
Fire resistance rating: **400/2**

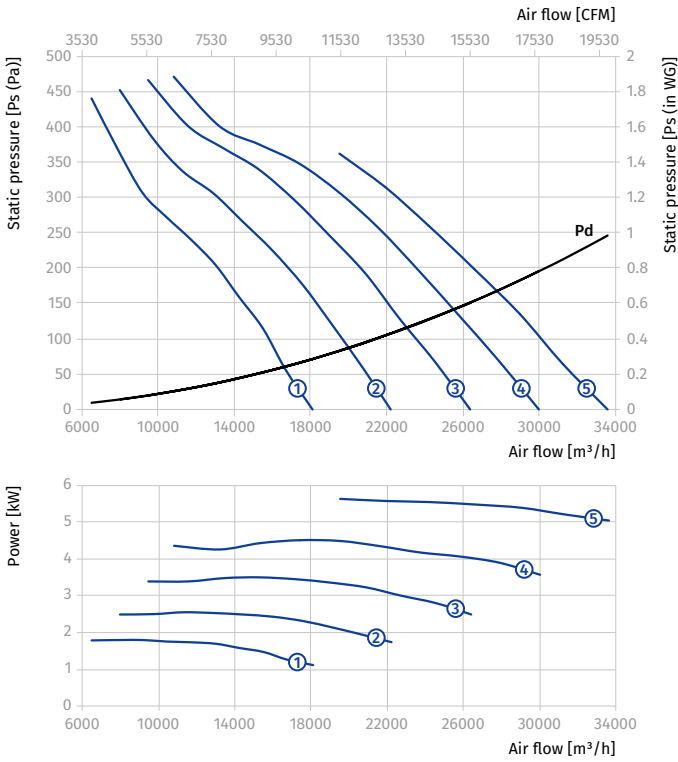

Standard size: **800**
Number of poles: **4**
Fire resistance rating: **400/2**

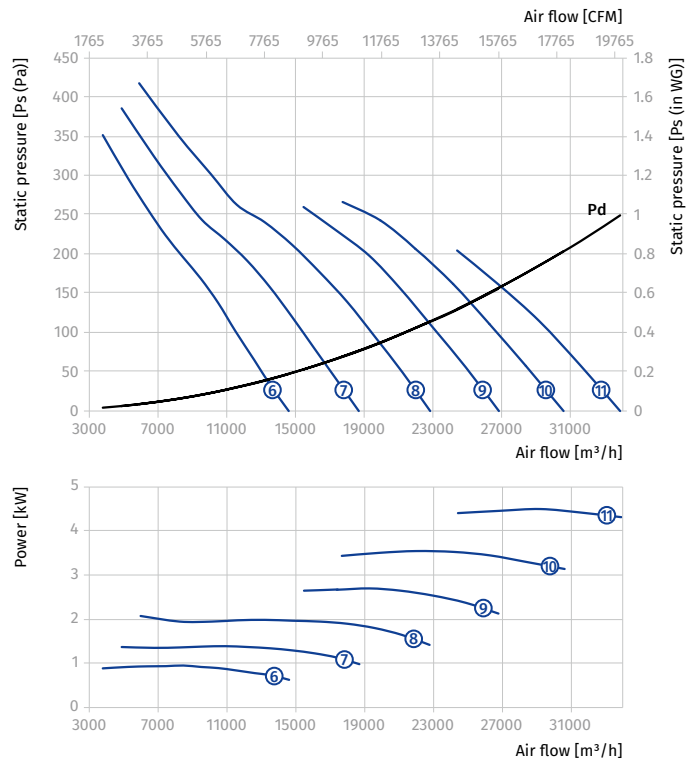

AXIS-FP 800...400/2

Size	Number of poles	Voltage [V/50 Hz]	Fan model	Installed motor power N_y [kW]	RPM [min^{-1}]	Number of blades	Blade setting angle [°]	Weight [kg]	Length L [mm]	Curve number on graph
Axis-FP 800-6D...400/2										
800	6	3~400	Axis-FP 800-6D/0.55-5/20/AL	0.55	960	5	20	65	400	①
			Axis-FP 800-6D/0.75-5/25/AL	0.75	960	5	25	71.5	450	②
			Axis-FP 800-6D/1.1-5/30/AL	1.1	960	5	30	75.5	450	③
			Axis-FP 800-6D/1.1-5/35/AL	1.1	960	5	35	75.5	450	④
			Axis-FP 800-6D/1.5-5/40/AL	1.5	960	5	40	88.5	550	⑤
			Axis-FP 800-6D/0.37-9/20/AL	0.37	960	9	20	53	400	⑥
			Axis-FP 800-6D/0.55-9/25/AL	0.55	960	9	25	56.5	400	⑦
			Axis-FP 800-6D/0.75-9/30/AL	0.75	960	9	30	60	400	⑧
			Axis-FP 800-6D/1.1-9/35/AL	1.1	960	9	35	64	400	⑨
			Axis-FP 800-6D/1.1-9/40/AL	1.1	960	9	40	64	400	⑩
			Axis-FP 800-6D/1.5-9/45/AL	1.5	960	9	45	76.5	500	⑪

Standard size: 800
 Number of poles: 6
 Fire resistance rating: 400/2

Standard size: 800
 Number of poles: 6
 Fire resistance rating: 400/2

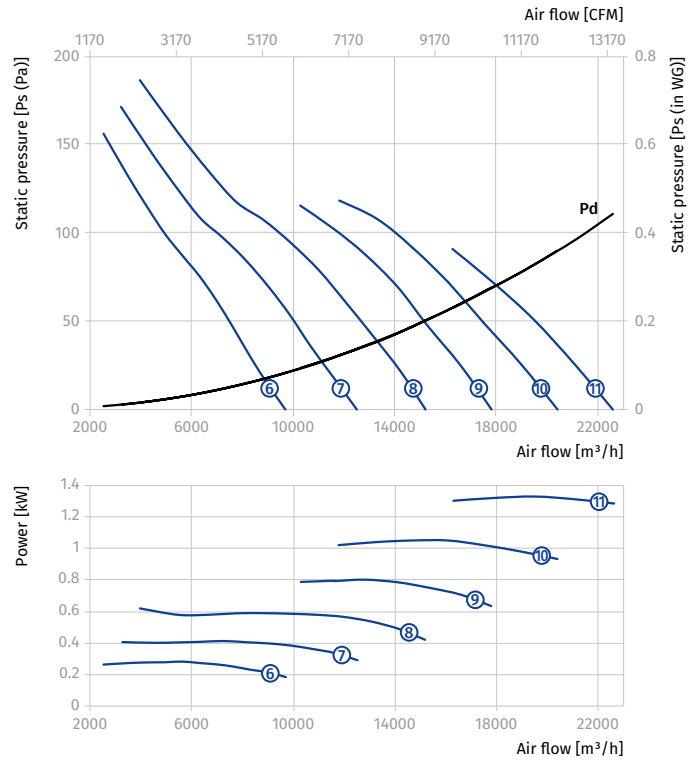
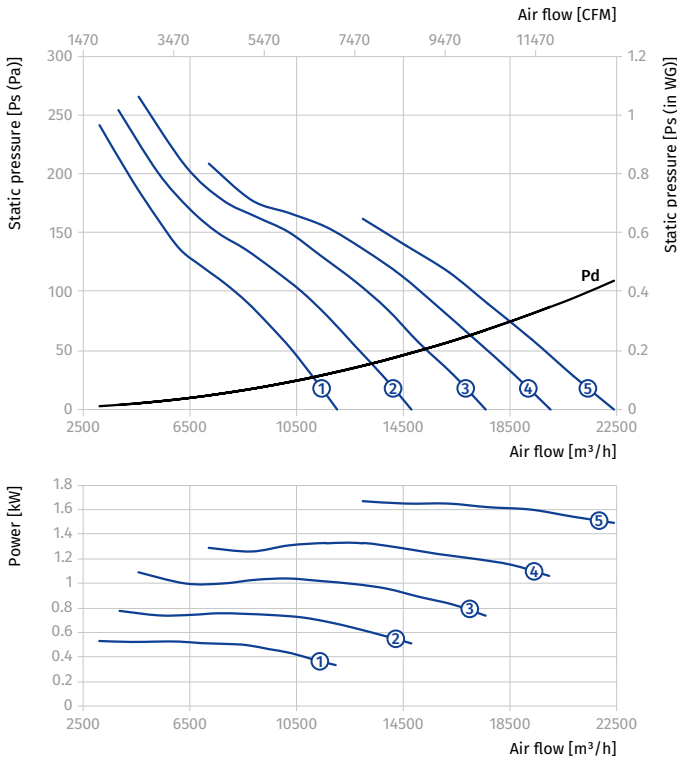

AXIAL SMOKE EXTRACTION FANS

AXIS-FP 800...400/2

Size	Number of poles	Voltage [V/50 Hz]	Fan model	Installed motor power Ny [kW]	RPM [min ⁻¹]	Number of blades	Blade setting angle [°]	Weight [kg]	Length L [mm]	Curve number on graph
Axis-FP 800-4/6D...400/2										
800	4/6	3~400	Axis-FP 800-4/6D/1.5/0.37-5/20/AL	1.5/0.37	1440/960	5	20	73.5	450	①
			Axis-FP 800-4/6D/2.2/0.7-5/25/AL	2.2/0.7	1440/960	5	25	88.5	450	②
			Axis-FP 800-4/6D/3/1-5/30/AL	3/1	1440/960	5	30	99.5	550	③
			Axis-FP 800-4/6D/4.5/1.5-5/35/AL	4.5/1.5	1440/960	5	35	136.5	600	④
			Axis-FP 800-4/6D/6/2.2-5/40/AL	6/2.2	1440/960	5	40	147.5	600	⑤

Standard size: 800
Number of poles: 4
Fire resistance rating: 400/2

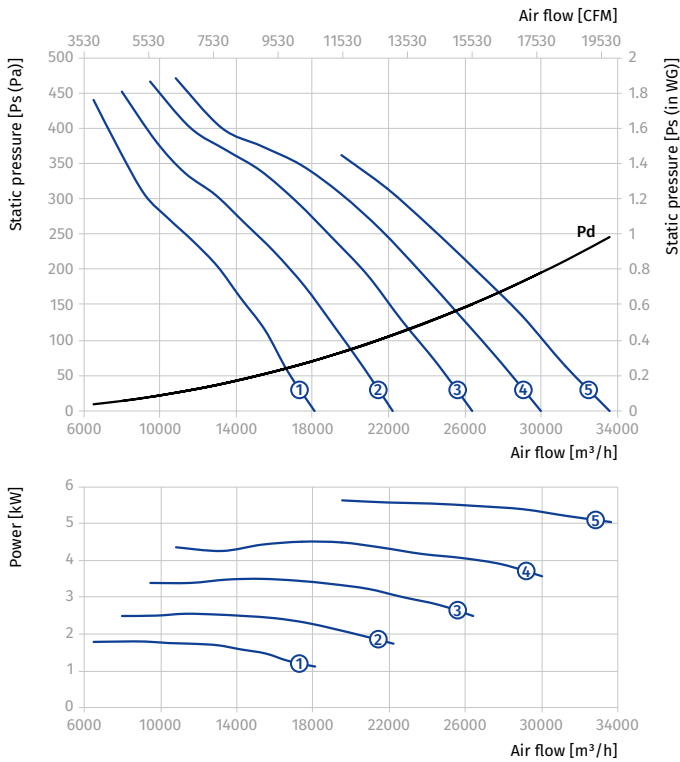

Standard size: 800
Number of poles: 6
Fire resistance rating: 400/2

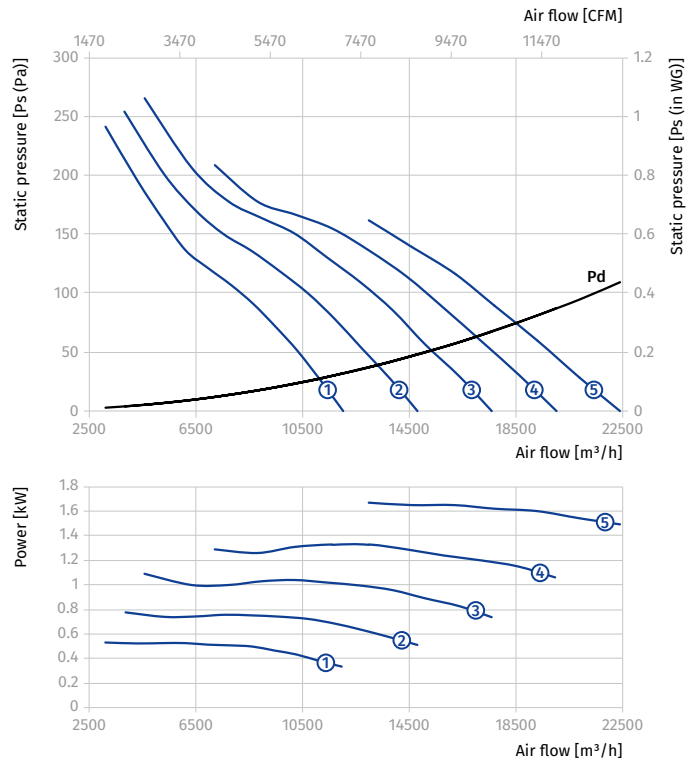

AXIS-FP 800...400/2

Size	Number of poles	Voltage [V/50 Hz]	Fan model	Installed motor power N_y [kW]	RPM [min ⁻¹]	Number of blades	Blade setting angle [°]	Weight [kg]	Length L [mm]	Curve number on graph
Axis-FP 800-4/6D...400/2										
800	4/6	3~400	Axis-FP 800-4/6D/1.1/0.3-9/20/AL	1.1/0.3	1440/960	9	20	58	400	①
			Axis-FP 800-4/6D/1.5/0.37-9/25/AL	1.5/0.37	1440/960	9	25	62	400	②
			Axis-FP 800-4/6D/2.2/0.7-9/30/AL	2.2/0.7	1440/960	9	30	76.5	500	③
			Axis-FP 800-4/6D/3/1-9/35/AL	3/1	1440/960	9	35	87.5	500	④
			Axis-FP 800-4/6D/4.5/1.5-9/40/AL	4.5/1.5	1440/960	9	40	125	550	⑤
			Axis-FP 800-4/6D/4.5/1.5-9/45/AL	4.5/1.5	1440/960	9	45	125	550	⑥

Standard size: 800
 Number of poles: 4
 Fire resistance rating: 400/2

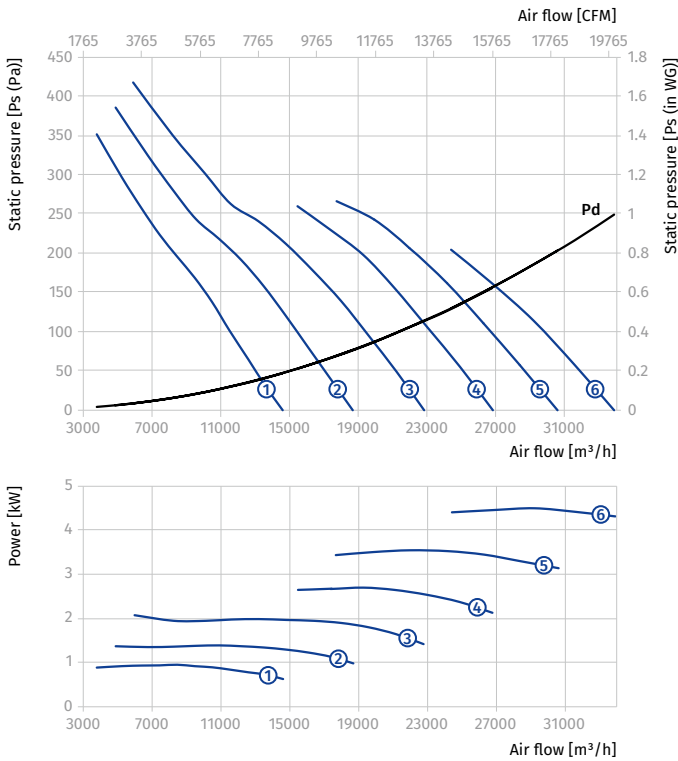

Standard size: 800
 Number of poles: 6
 Fire resistance rating: 400/2

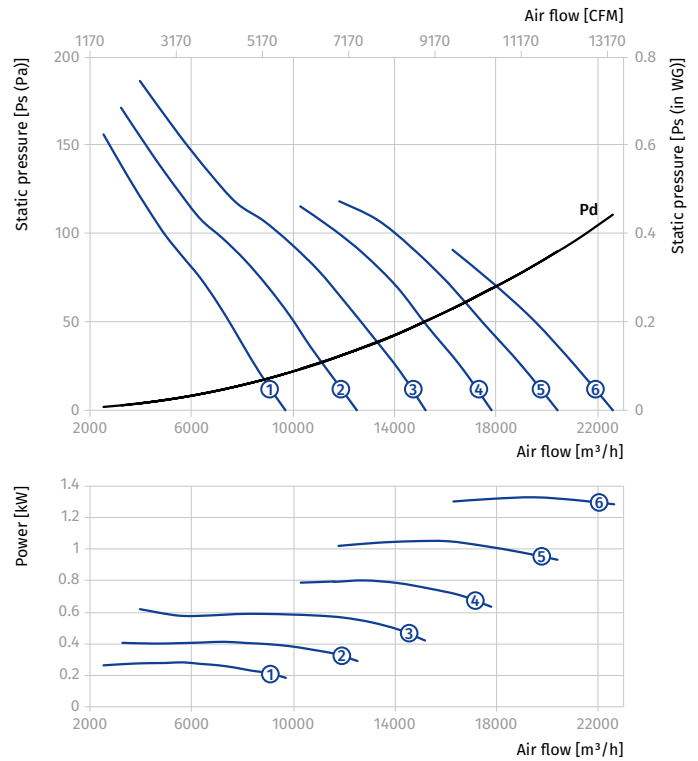

AXIAL SMOKE EXTRACTION FANS

AXIS-FP 800...400/2

Size	Number of poles	Voltage [V/50 Hz]	Fan model	Installed motor power Ny [kW]	RPM [min ⁻¹]	Number of blades	Blade setting angle [°]	Weight [kg]	Length L [mm]	Curve number on graph
Axis-FP 800-4/8D...400/2										
800	4/8	3~400	Axis-FP 800-4/8D/1.6/0.4-5/20/AL	1.6/0.4	1440/720	5	20	77	450	①
			Axis-FP 800-4/8D/2.2/0.55-5/25/AL	2.2/0.55	1440/720	5	25	91.5	550	②
			Axis-FP 800-4/8D/2.8/0.7-5/30/AL	2.8/0.7	1440/720	5	30	94.5	550	③
			Axis-FP 800-4/8D/3.8/1-5/35/AL	3.8/1	1440/720	5	35	106.5	550	④
			Axis-FP 800-4/8D/5/1.3-5/40/AL	5/1.3	1440/720	5	40	136.5	600	⑤

Standard size: 800
Number of poles: 4
Fire resistance rating: 400/2

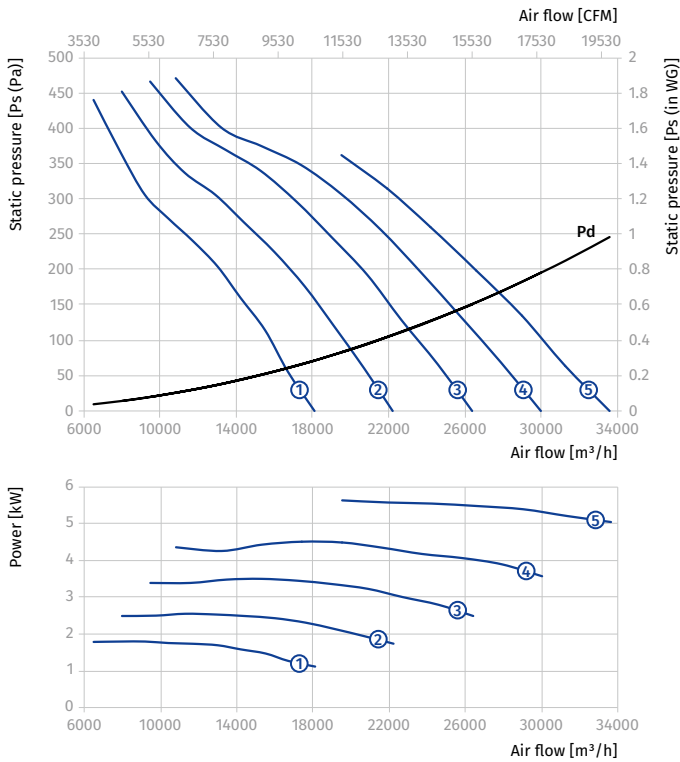

Standard size: 800
Number of poles: 8
Fire resistance rating: 400/2

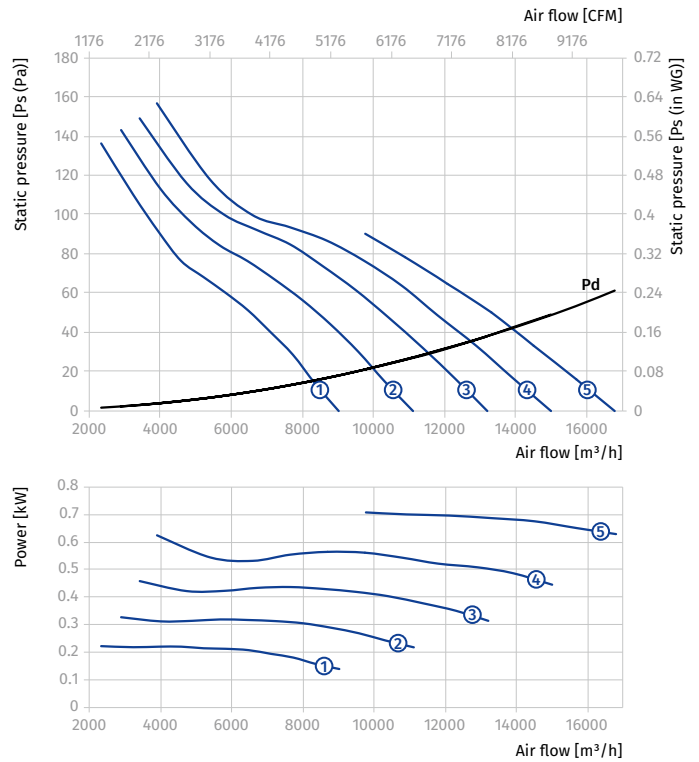

AXIS-FP 800...400/2

Size	Number of poles	Voltage [V/50 Hz]	Fan model	Installed motor power N_y [kW]	RPM [min^{-1}]	Number of blades	Blade setting angle [°]	Weight [kg]	Length L [mm]	Curve number on graph
Axis-FP 800-4/8D...400/2										
800	4/8	3~400	Axis-FP 800-4/8D/1.2/0.3-9/20/AL	1.2/0.3	720	9	20	62	400	①
			Axis-FP 800-4/8D/1.6/0.4-9/25/AL	1.6/0.4	720	9	25	65	400	②
			Axis-FP 800-4/8D/2.2/0.55-9/30/AL	2.2/0.55	720	9	30	79.5	500	③
			Axis-FP 800-4/8D/2.8/0.7-9/35/AL	2.8/0.7	720	9	35	82.5	500	④
			Axis-FP 800-4/8D/3.8/1-9/40/AL	3.8/1	720	9	40	94.5	500	⑤
			Axis-FP 800-4/8D/5/1.3-9/45/AL	5/1.3	720	9	45	125	550	⑥

Standard size: 800
 Number of poles: 4
 Fire resistance rating: 400/2

Standard size: 800
 Number of poles: 8
 Fire resistance rating: 400/2

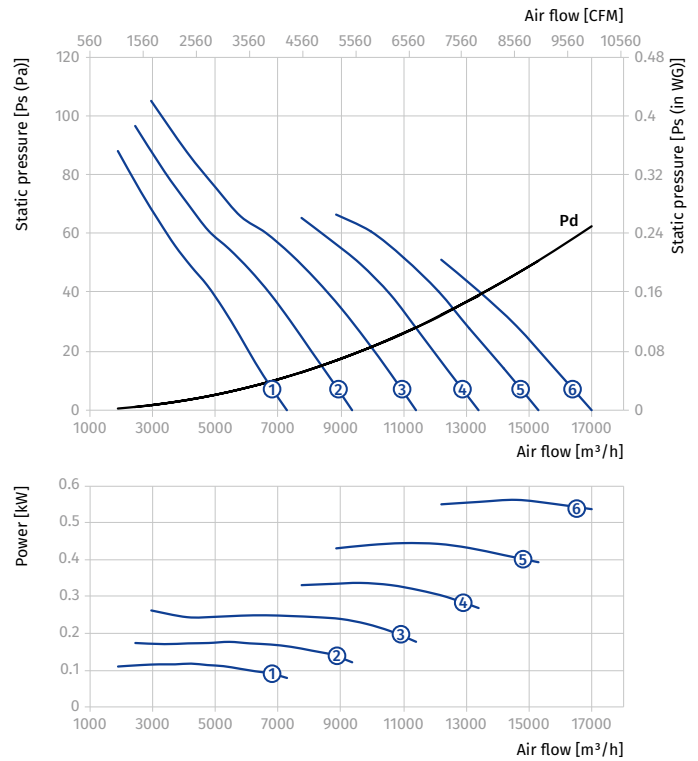
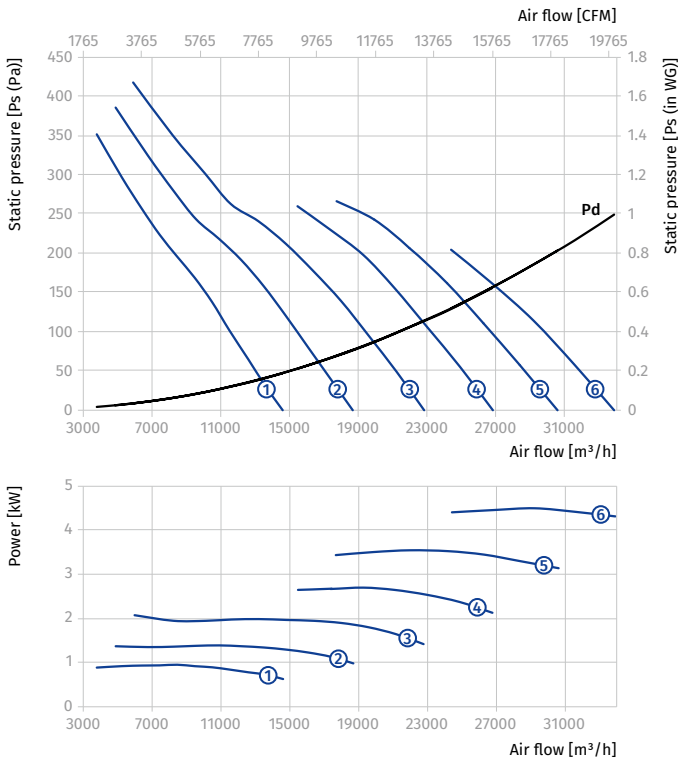

AXIS-FP 900...400/2

Size	Number of poles	Voltage [V/50 Hz]	Fan model	Installed motor power Ny [kW]	RPM [min ⁻¹]	Number of blades	Blade setting angle [°]	Weight [kg]	Length L [mm]	Curve number on graph
Axis-FP 900-4D...400/2										
900	4	3~400	Axis-FP 900-4D/3-6/20/AL	3	1440	6	20	101	550	①
			Axis-FP 900-4D/4-6/25/AL	4	1440	6	25	106	550	②
			Axis-FP 900-4D/5.5-6/29/AL	5.5	1440	6	29	141.5	600	③
			Axis-FP 900-4D/7.5-6/35/AL	7.5	1440	6	35	159	600	④
			Axis-FP 900-4D/9.2-6/39/AL	9.2	1440	6	39	164.5	600	⑤
			Axis-FP 900-4D/11-6/43/AL	11	1440	6	43	177.5	600	⑥
Axis-FP 900-6D...400/2										
900	6	3~400	Axis-FP 900-6D/0.75-5/20/AL	0.75	960	5	20	78	450	①
			Axis-FP 900-6D/1.1-6/24/AL	1.1	960	6	24	84	450	②
			Axis-FP 900-6D/1.5-6/28/AL	1.5	960	6	28	98	550	③
			Axis-FP 900-6D/2.2-6/35/AL	2.2	960	6	35	110	550	④
			Axis-FP 900-6D/3-6/41/AL	3	960	6	41	149.5	600	⑤

Standard size: 900
Number of poles: 4
Fire resistance rating: 400/2

Standard size: 900
Number of poles: 6
Fire resistance rating: 400/2

AXIAL SMOKE EXTRACTION FANS

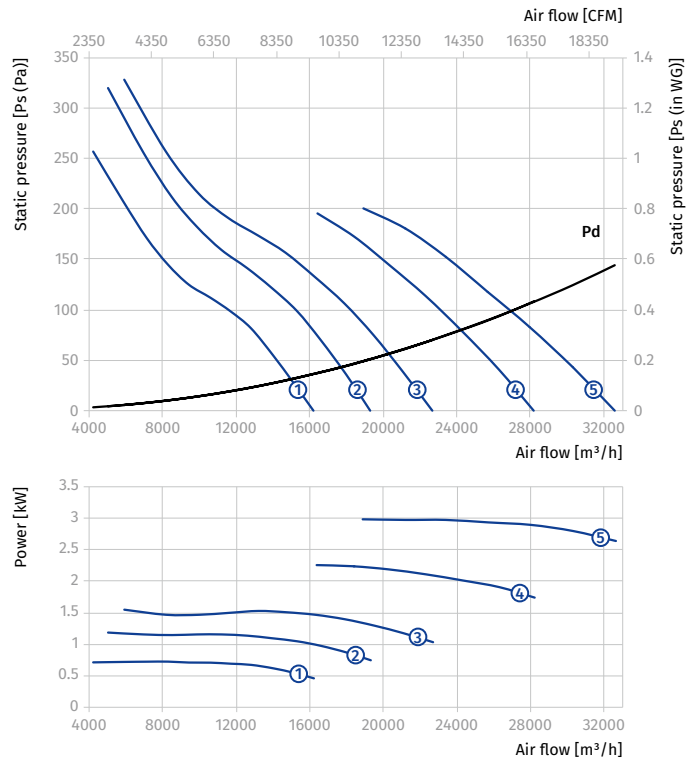
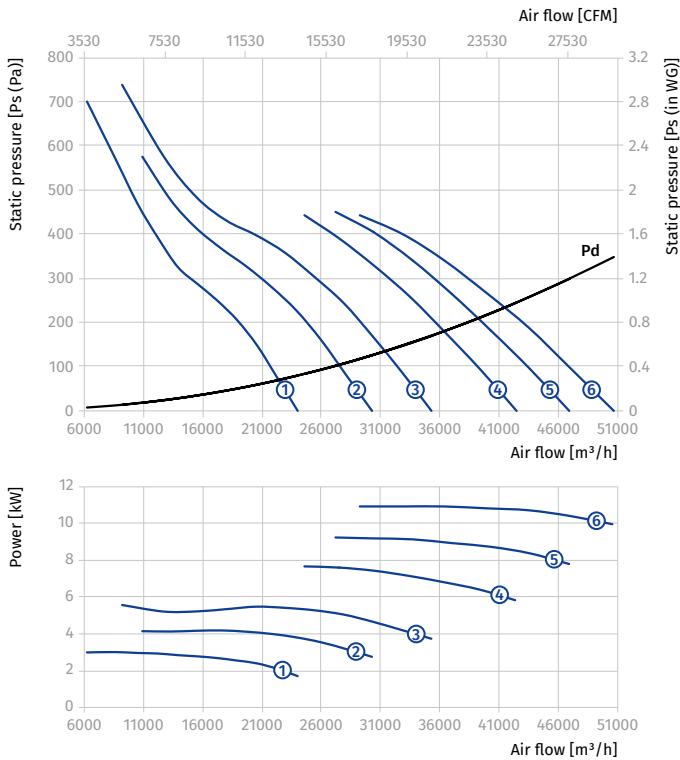

AXIS-FP 900...400/2

Size	Number of poles	Voltage [V/50 Hz]	Fan model	Installed motor power N_y [kW]	RPM [min^{-1}]	Number of blades	Blade setting angle [°]	Weight [kg]	Length L [mm]	Curve number on graph
Axis-FP 900-4/6D...400/2										
900	4/6	3~400	Axis-FP 900-4/6D/3/1-6/20/AL	3/1	1440/960	6	20	109	550	①
			Axis-FP 900-4/6D/4.5/1.5-6/26/AL	4.5/1.5	1440/960	6	26	162.5	600	②
			Axis-FP 900-4/6D/6/2.2-6/31/AL	6/2.2	1440/960	6	31	173.5	600	③
			Axis-FP 900-4/6D/10/3.3-6/41/AL	10/3.3	1440/960	6	41	236.5	750	④

Standard size: 900
 Number of poles: 4
 Fire resistance rating: 400/2

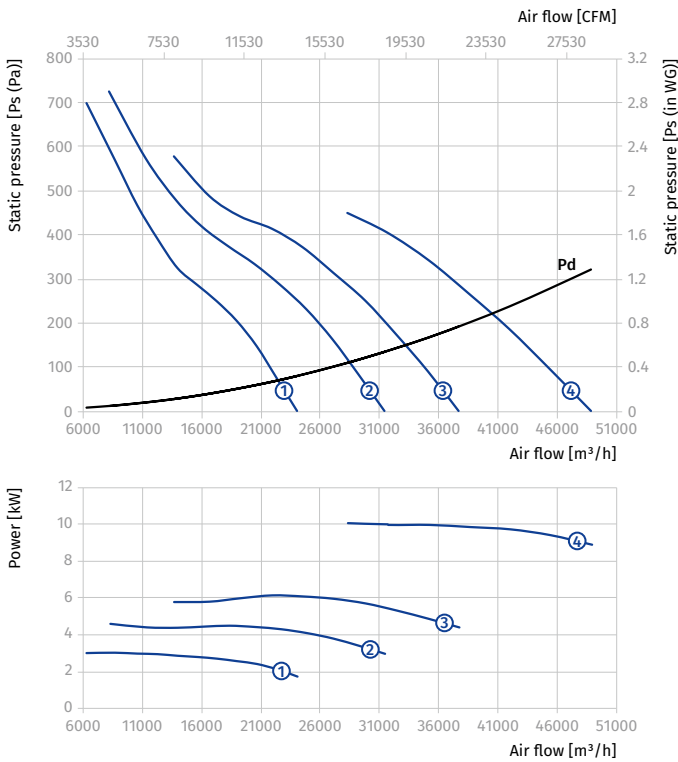

Standard size: 900
 Number of poles: 6
 Fire resistance rating: 400/2

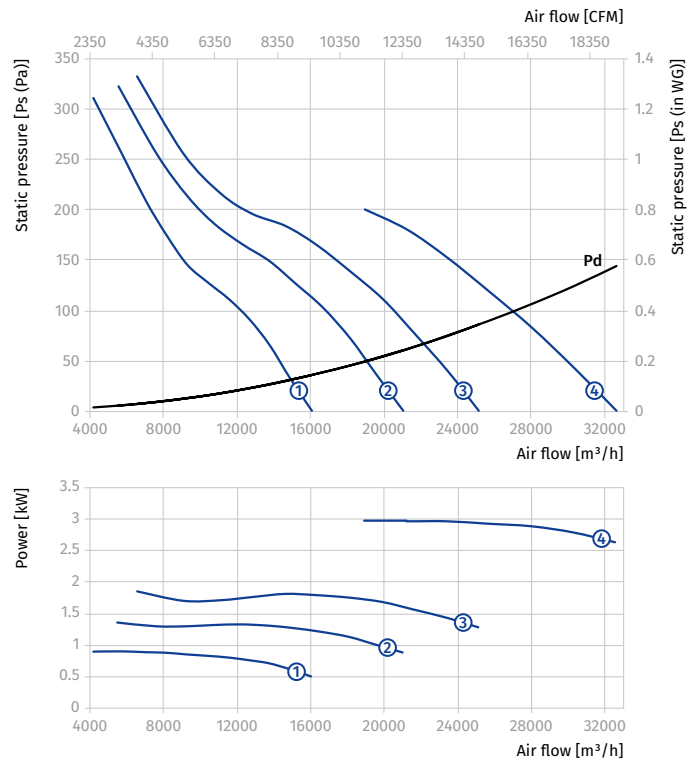

AXIS-FP 900...400/2

Size	Number of poles	Voltage [V/50 Hz]	Fan model	Installed motor power Ny [kW]	RPM [min ⁻¹]	Number of blades	Blade setting angle [°]	Weight [kg]	Length L [mm]	Curve number on graph
Axis-FP 900-4/8D...400/2										
900	4/8	3~400	Axis-FP 900-4/8D/2.8/0.7-6/20/AL	2.8/0.7	1440/720	6	20	104	550	①
			Axis-FP 900-4/8D/3.8/1-6/23/AL	3.8/1	1440/720	6	23	116	550	②
			Axis-FP 900-4/8D/5/1.3-6/28/AL	5/1.3	1440/720	6	28	162.5	600	③
			Axis-FP 900-4/8D/7.2/1.8-6/34/AL	7.2/1.8	1440/720	6	34	174.5	600	④
			Axis-FP 900-4/8D/11/3-6/43/AL	11/3	1440/720	6	43	235.5	750	⑤

Standard size: **900**
Number of poles: **4**
Fire resistance rating: **400/2**

Standard size: **900**
Number of poles: **8**
Fire resistance rating: **400/2**

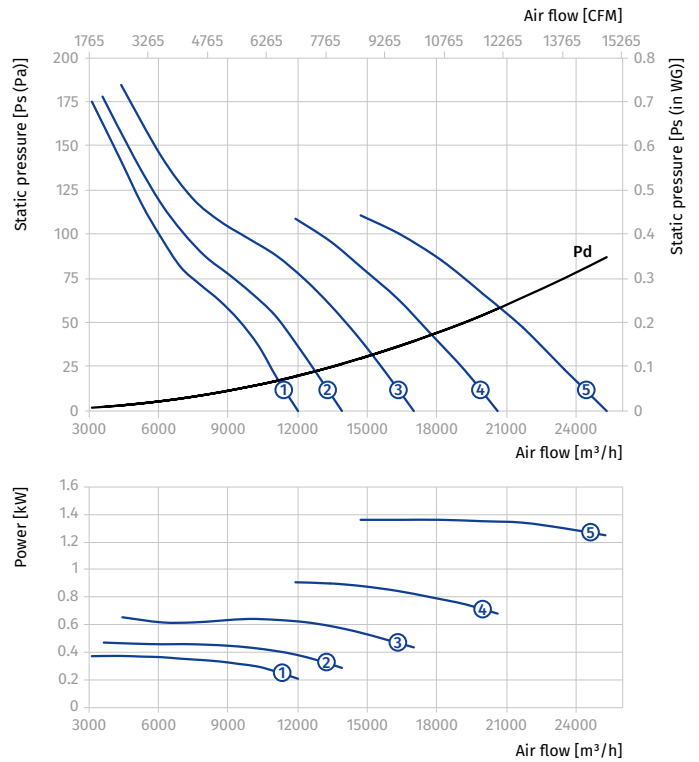
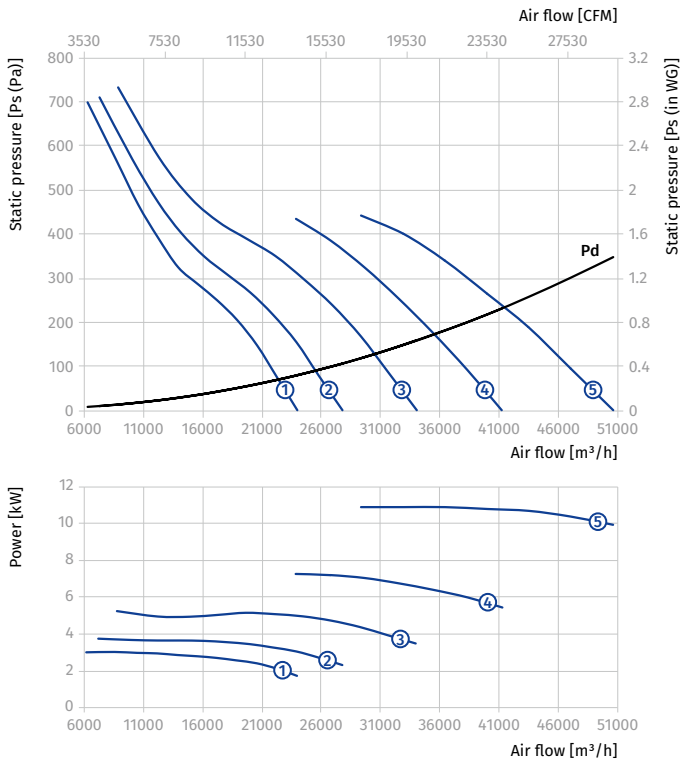

AXIAL SMOKE EXTRACTION FANS

AXIS-FP 1000...400/2

Size	Number of poles	Voltage [V/50 Hz]	Fan model	Installed motor power Ny [kW]	RPM [min ⁻¹]	Number of blades	Blade setting angle [°]	Weight [kg]	Length L [mm]	Curve number on graph
Axis-FP 1000-4D...400/2										
1000	4	3~400	Axis-FP 1000-4D/5.5-6/24/AL	5.5	1440	6	24	150	600	①
			Axis-FP 1000-4D/7.5-6/30/AL	7.5	1440	6	30	167	600	②
			Axis-FP 1000-4D/9.2-6/33/AL	9.2	1440	6	33	173	600	③
			Axis-FP 1000-4D/11-6/36/AL	11	1440	6	36	186	600	④
			Axis-FP 1000-4D/15-6/43/AL	15	1440	6	43	247	750	⑤
			Axis-FP 1000-4D/18.5-6/48/AL	18.5	1440	6	48	262	750	⑥
Axis-FP 1000-6D...400/2										
1000	6	3~400	Axis-FP 1000-6D/1.5-6/23/AL	1.5	960	6	23	103.5	550	①
			Axis-FP 1000-6D/2.2-6/29/AL	2.2	960	6	29	116	550	②
			Axis-FP 1000-6D/3-6/35/AL	3	960	6	35	158	600	③
			Axis-FP 1000-6D/4-6/41/AL	4	960	6	41	162	600	④
			Axis-FP 1000-6D/5.5-6/48/AL	5.5	960	6	48	175	600	⑤

Standard size: 1000
 Number of poles: 4
 Fire resistance rating: 400/2

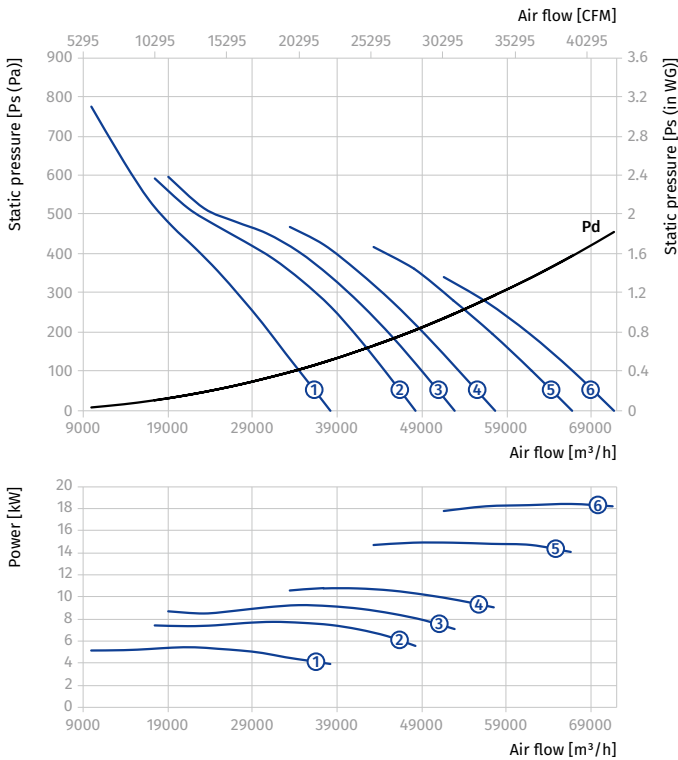

Standard size: 1000
 Number of poles: 6
 Fire resistance rating: 400/2

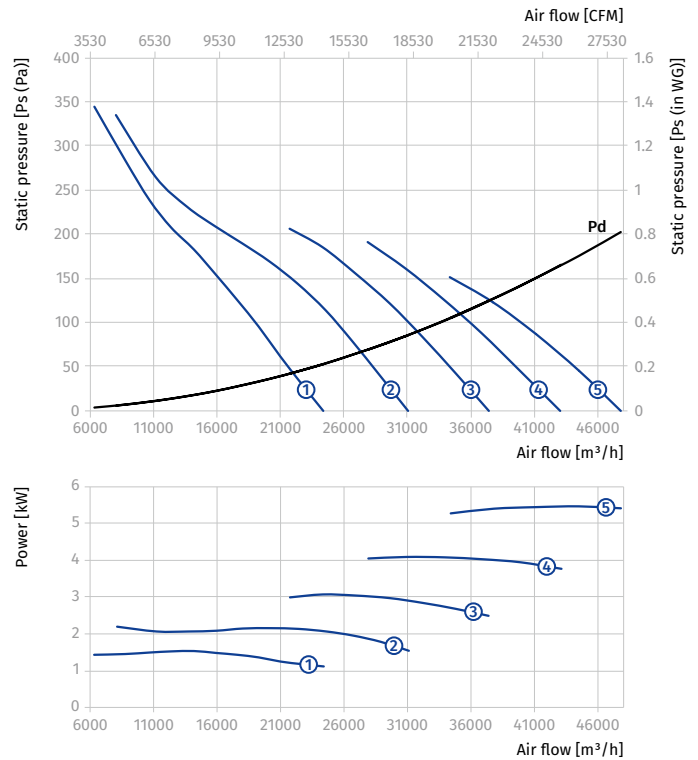

AXIS-FP 1000...400/2

Size	Number of poles	Voltage [V/50 Hz]	Fan model	Installed motor power Ny [kW]	RPM [min ⁻¹]	Number of blades	Blade setting angle [°]	Weight [kg]	Length L [mm]	Curve number on graph
Axis-FP 1000-4/6D...400/2										
1000	4/6	3~400	Axis-FP 1000-4/6D/4.5/1.5-6/20/AL	4.5/1.5	1440/960	6	20	171	600	①
			Axis-FP 1000-4/6D/6/2.2-6/25/AL	6/2.2	1440/960	6	25	182	600	②
			Axis-FP 1000-4/6D/10/3.3-6/34/AL	10/3.3	1440/960	6	34	247	750	③
			Axis-FP 1000-4/6D/14/4.5-6/41/AL	14/4.5	1440/960	6	41	262	750	④
			Axis-FP 1000-4/6D/16/6.5-6/45/AL	16/6.5	1440/960	6	45	330.5	800	⑤

Standard size: 1000
Number of poles: 4
Fire resistance rating: 400/2

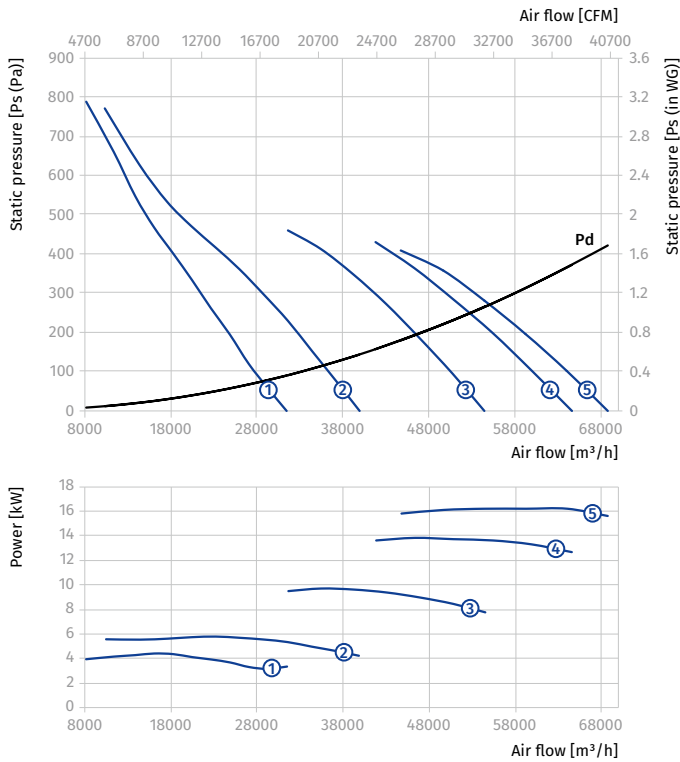

Standard size: 1000
Number of poles: 6
Fire resistance rating: 400/2

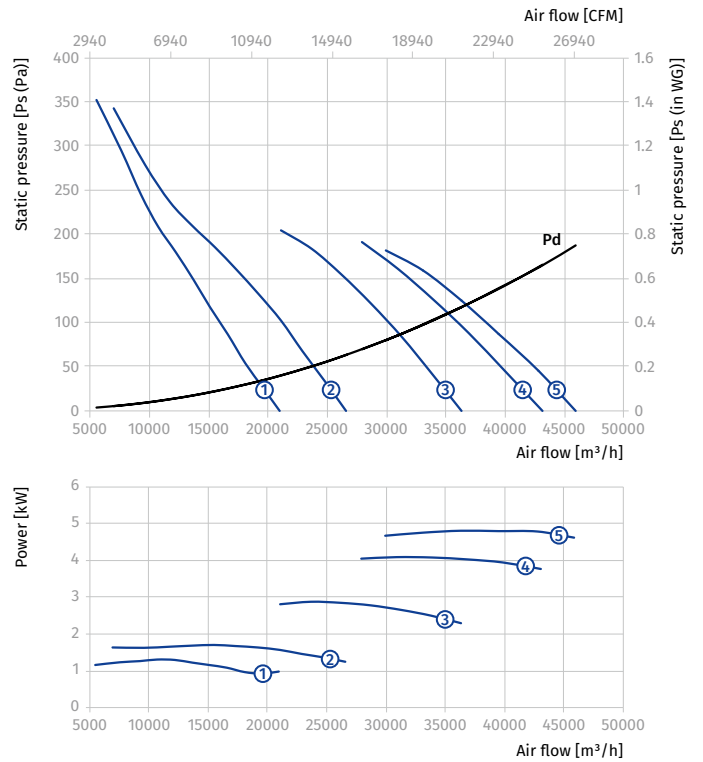

AXIAL SMOKE EXTRACTION FANS

AXIS-FP 1000...400/2

Size	Number of poles	Voltage [V/50 Hz]	Fan model	Installed motor power N_y [kW]	RPM [min^{-1}]	Number of blades	Blade setting angle [°]	Weight [kg]	Length L [mm]	Curve number on graph
Axis-FP 1000-4/8D...400/2										
1000	4/8	3~400	Axis-FP 1000-4/8D/5/1.3-6/23/AL	5/1.3	1440/720	6	23	171	600	①
			Axis-FP 1000-4/8D/7.2/1.8-6/29/AL	7.2/1.8	1440/720	6	29	183	600	②
			Axis-FP 1000-4/8D/11/3-6/36/AL	11/3	1440/720	6	36	246	750	③
			Axis-FP 1000-4/8D/14/3.5-6/41/AL	14/3.5	1440/720	6	41	262	750	④
			Axis-FP 1000-4/8D/17/4.3-6/46/AL	17/4.3	1440/720	6	46	297.5	800	⑤

Standard size: 1000
 Number of poles: 4
 Fire resistance rating: 400/2

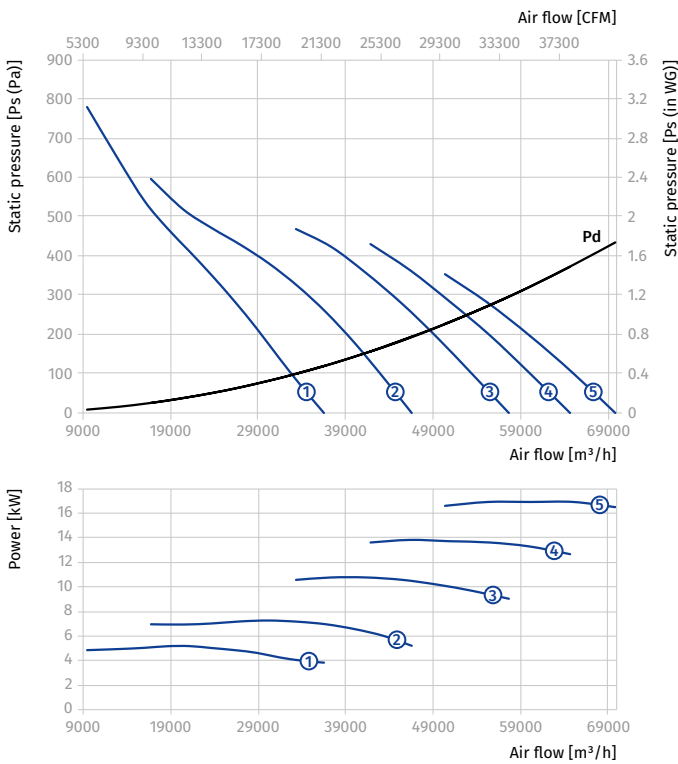

Standard size: 1000
 Number of poles: 8
 Fire resistance rating: 400/2

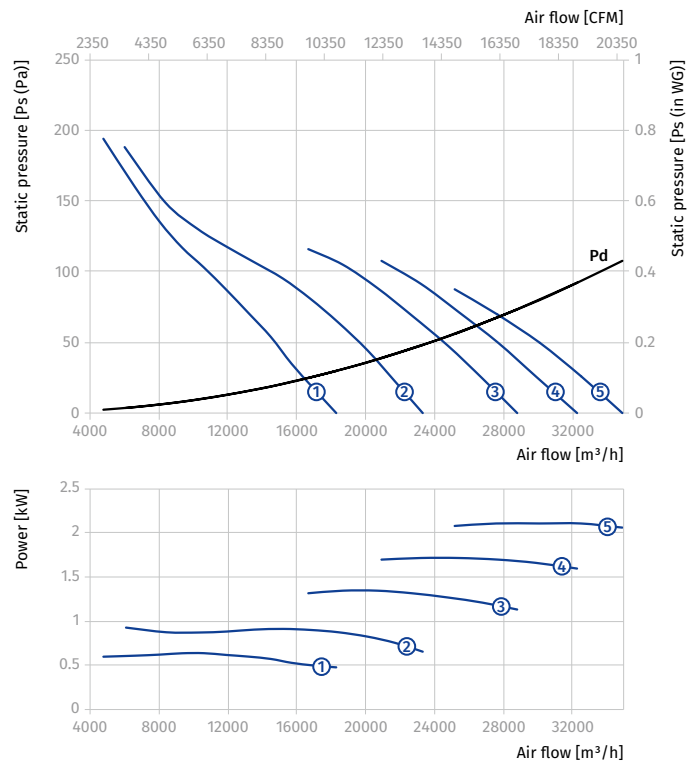

AXIS-FP 1120...400/2

Size	Number of poles	Voltage [V/50 Hz]	Fan model	Installed motor power Ny [kW]	RPM [min ⁻¹]	Number of blades	Blade setting angle [°]	Weight [kg]	Length L [mm]	Curve number on graph
Axis-FP 1120-4D...400/2										
1120	4	3~400	Axis-FP 1120-4D/7.5-6/23/AL	7.5	1440	6	23	186	600	①
			Axis-FP 1120-4D/9.2-6/27/AL	9.2	1440	6	27	191	600	②
			Axis-FP 1120-4D/11-6/31/AL	11	1440	6	31	204	600	③
			Axis-FP 1120-4D/15-6/35/AL	15	1440	6	35	299	750	④
			Axis-FP 1120-4D/18.5-6/40/AL	18.5	1440	6	40	314	750	⑤
			Axis-FP 1120-4D/22-6/43/AL	22	1440	6	43	355	800	⑥
Axis-FP 1120-6D...400/2										
1120	6	3~400	Axis-FP 1120-6D/2.2-6/23/AL	2.2	960	6	23	149	550	①
			Axis-FP 1120-6D/3-6/29/AL	3	960	6	29	176	600	②
			Axis-FP 1120-6D/4-6/34/AL	4	960	6	34	180	600	③
			Axis-FP 1120-6D/5.5-6/40/AL	5.5	960	6	40	193	600	④
			Axis-FP 1120-6D/7.5-6/46/AL	7.5	960	6	46	282	750	⑤
			Axis-FP 1120-6D/9.2-6/50/AL	9.2	960	6	50	292	750	⑥

Standard size: 1120
Number of poles: 4
Fire resistance rating: 400/2

Standard size: 1120
Number of poles: 6
Fire resistance rating: 400/2

AXIAL SMOKE EXTRACTION FANS

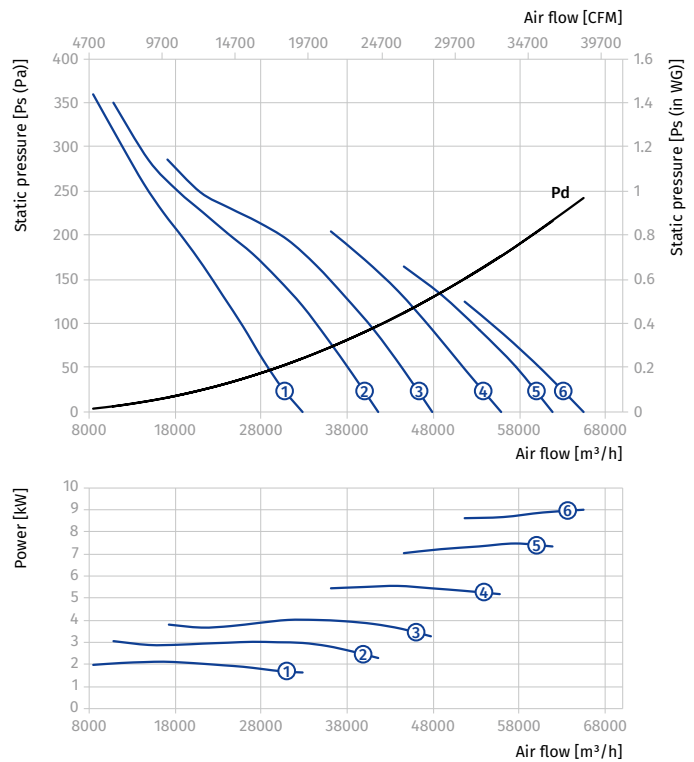
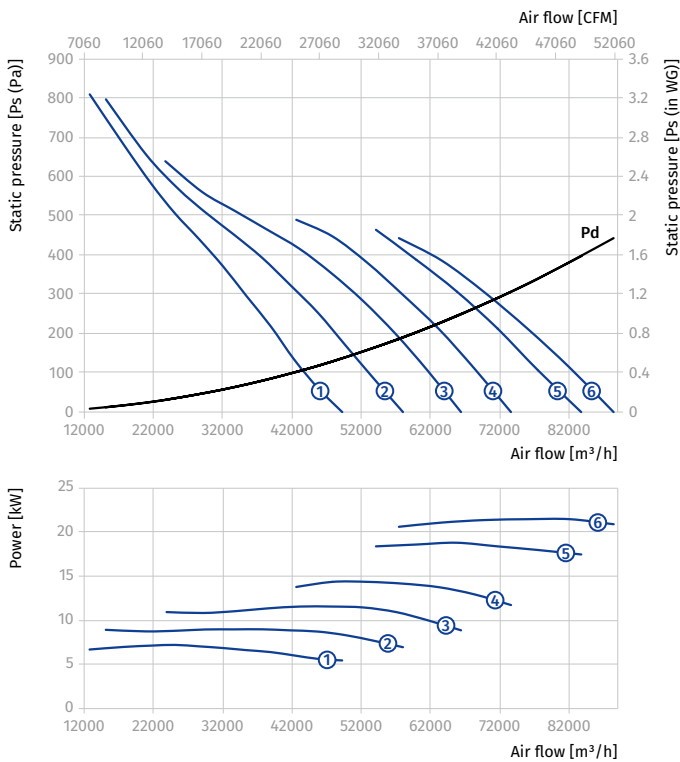

AXIS-FP 1120...400/2

Size	Number of poles	Voltage [V/50 Hz]	Fan model	Installed motor power N_y [kW]	RPM [min ⁻¹]	Number of blades	Blade setting angle [°]	Weight [kg]	Length L [mm]	Curve number on graph
Axis-FP 1120-4/6D...400/2										
1120	4/6	3~400	Axis-FP 1120-4/6D/6/2.2-5/24/AL	6/2.2	1440/960	5	24	198	600	①
			Axis-FP 1120-4/6D/10/3.3-6/29/AL	10/3.3	1440/960	6	29	299	750	②
			Axis-FP 1120-4/6D/14/4.5-6/34/AL	14/4.5	1440/960	6	34	314	750	③
			Axis-FP 1120-4/6D/16/6.5-6/37/AL	16/6.5	1440/960	6	37	386	800	④
			Axis-FP 1120-4/6D/20/8.5-6/41/AL	20/8.5	1440/960	6	41	389	800	⑤

Standard size: 1120
 Number of poles: 4
 Fire resistance rating: 400/2

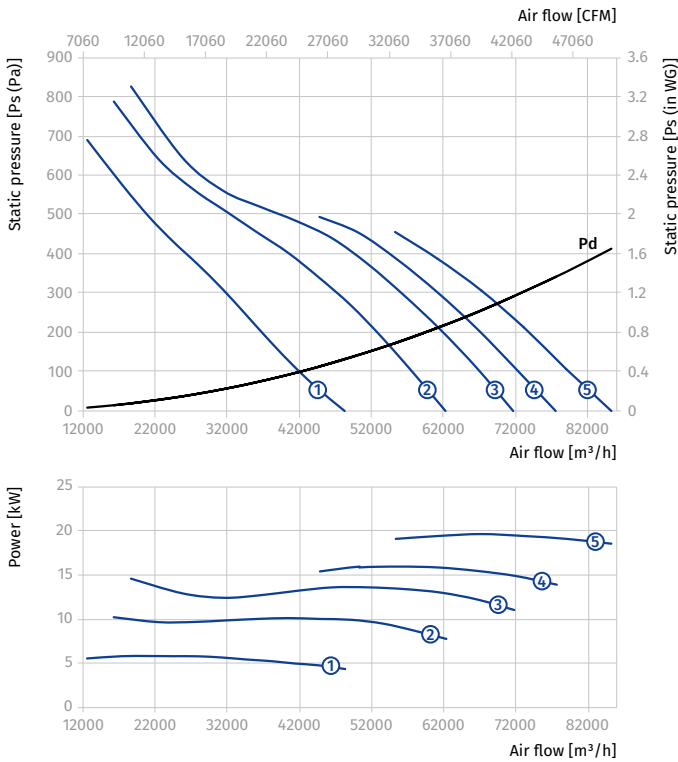

Standard size: 1120
 Number of poles: 6
 Fire resistance rating: 400/2

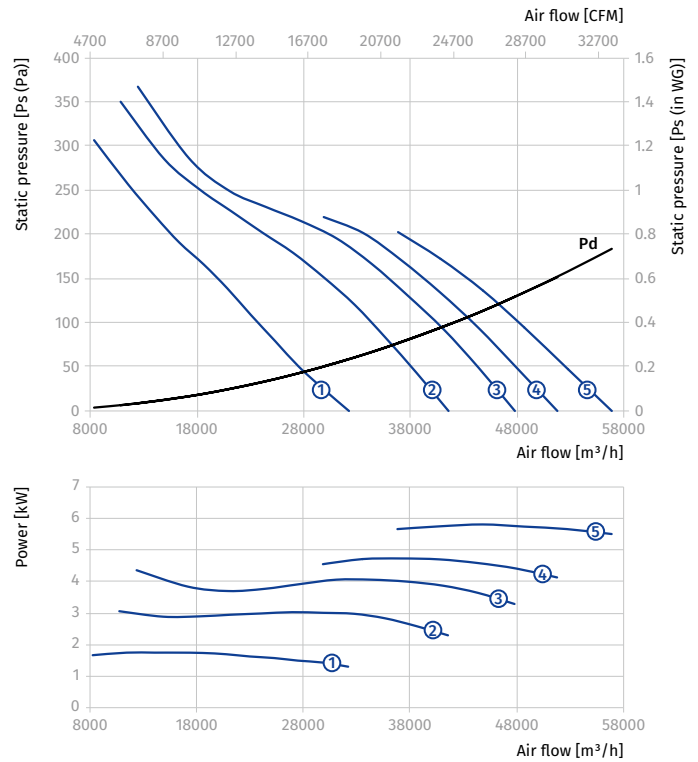

AXIAL SMOKE EXTRACTION FANS

AXIS-FP 1120...400/2

Size	Number of poles	Voltage [V/50 Hz]	Fan model	Installed motor power Ny [kW]	RPM [min ⁻¹]	Number of blades	Blade setting angle [°]	Weight [kg]	Length L [mm]	Curve number on graph
Axis-FP 1120-4/8D...400/2										
1120	4/8	3~400	Axis-FP 1120-4/8D/7.2/1.8-6/23/AL	7.2/1.8	1440/720	6	23	201	600	①
			Axis-FP 1120-4/8D/11/3-6/31/AL	11/3	1440/720	6	31	298	750	②
			Axis-FP 1120-4/8D/14/3.5-6/34/AL	14/3.5	1440/720	6	34	314	750	③
			Axis-FP 1120-4/8D/17/4.3-6/38/AL	17/4.3	1440/720	6	38	353	800	④
			Axis-FP 1120-4/8D/20/5-6/41/AL	20/5	1440/720	6	41	381	800	⑤

Standard size: 1120
Number of poles: 4
Fire resistance rating: 400/2

Standard size: 1120
Number of poles: 8
Fire resistance rating: 400/2

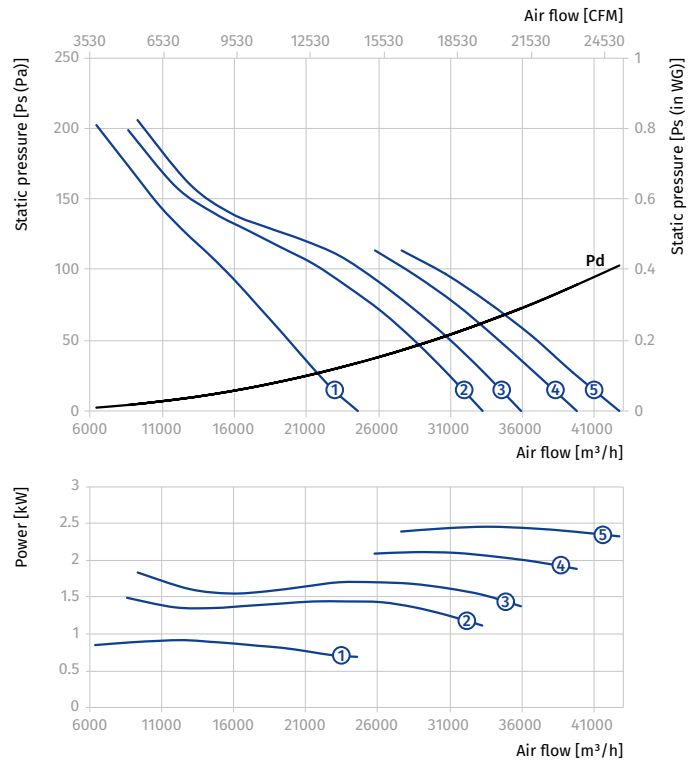
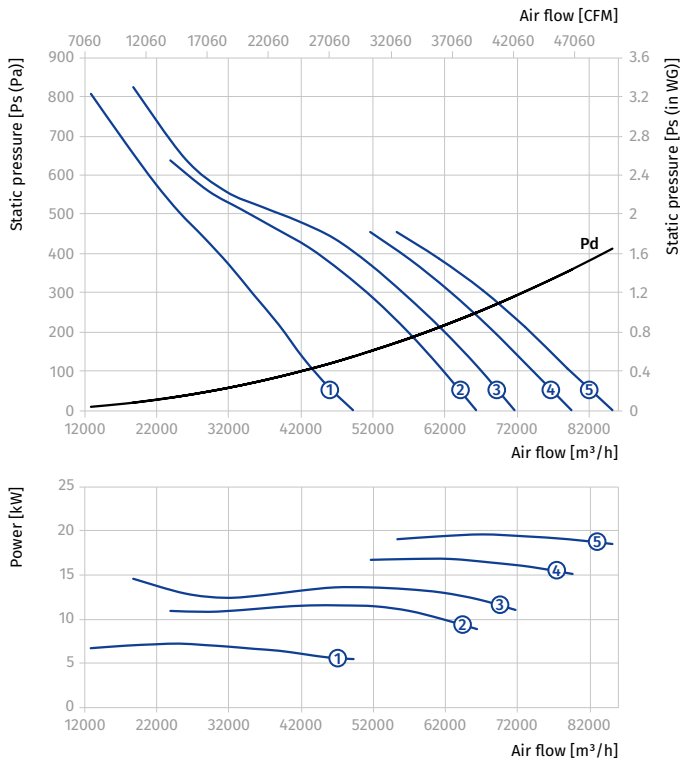

AXIAL SMOKE EXTRACTION FANS

AXIS-FP 1250...400/2

Size	Number of poles	Voltage [V/50 Hz]	Fan model	Installed motor power N_y [kW]	RPM [min^{-1}]	Number of blades	Blade setting angle [°]	Weight [kg]	Length L [mm]	Curve number on graph
Axis-FP 1250-4D...400/2										
1250	4	3~400	Axis-FP 1250-4D/18.5-8/23/AL	18.5	1440	8	23	340	750	①
			Axis-FP 1250-4D/22-8/28/AL	22	1440	8	28	382	800	②
			Axis-FP 1250-4D/30-8/34/AL	30	1440	8	34	408	800	③
Axis-FP 1250-6D...400/2										
1250	6	3~400	Axis-FP 1250-6D/5.5-8/23/AL	5.5	960	8	23	236	600	①
			Axis-FP 1250-6D/7.5-8/30/AL	7.5	960	8	30	308	750	②
			Axis-FP 1250-6D/9.2-8/34/AL	9.2	960	8	34	318	750	③
			Axis-FP 1250-6D/11-8/38/AL	11	960	8	38	332	750	④

Standard size: 1250
 Number of poles: 4
 Fire resistance rating: 400/2

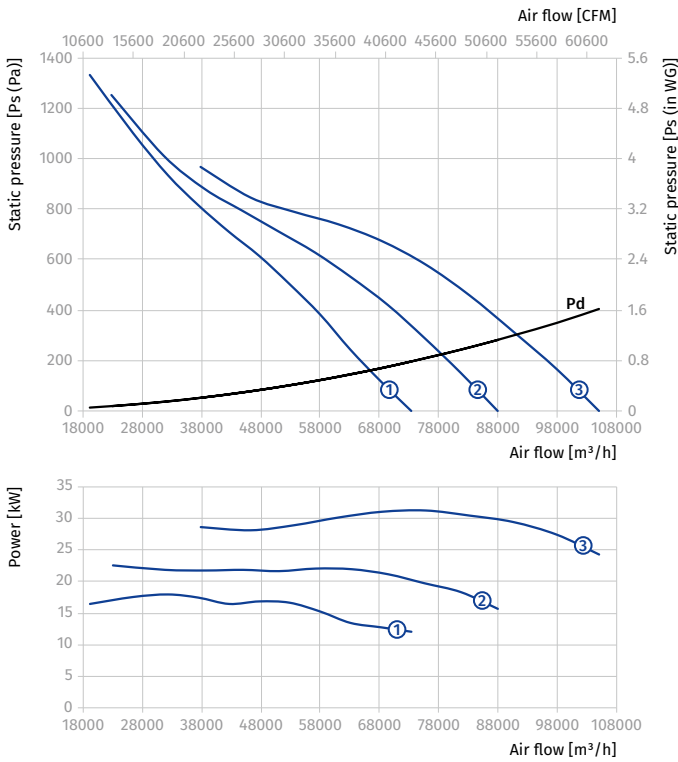

Standard size: 1250
 Number of poles: 6
 Fire resistance rating: 400/2

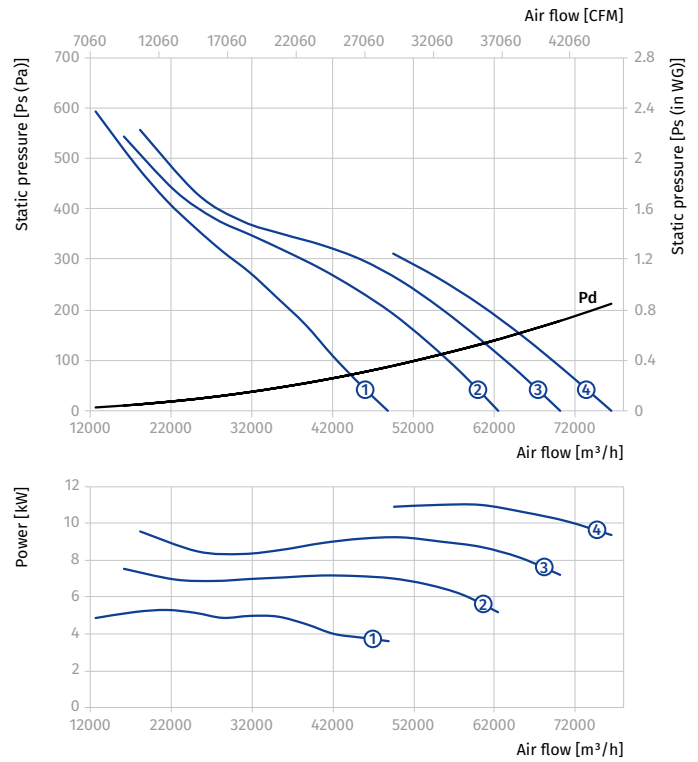

AXIAL SMOKE EXTRACTION FANS

AXIS-FP 1250...400/2

Size	Number of poles	Voltage [V/50 Hz]	Fan model	Installed motor power Ny [kW]	RPM [min ⁻¹]	Number of blades	Blade setting angle [°]	Weight [kg]	Length L [mm]	Curve number on graph
Axis-FP 1250-4/6D...400/2										
1250	4/6	3~400	Axis-FP 1250-4/6D/16/6.5-8/20/AL	16/6.5	1440/960	8	20	413.2	800	①
			Axis-FP 1250-4/6D/20/8.5-8/25/AL	20/8.5	1440/960	8	25	416	800	②
			Axis-FP 1250-4/6D/26/9-8/31/AL	26/9	1440/960	8	31	514	850	③

Standard size: 1250
Number of poles: 4
Fire resistance rating: 400/2

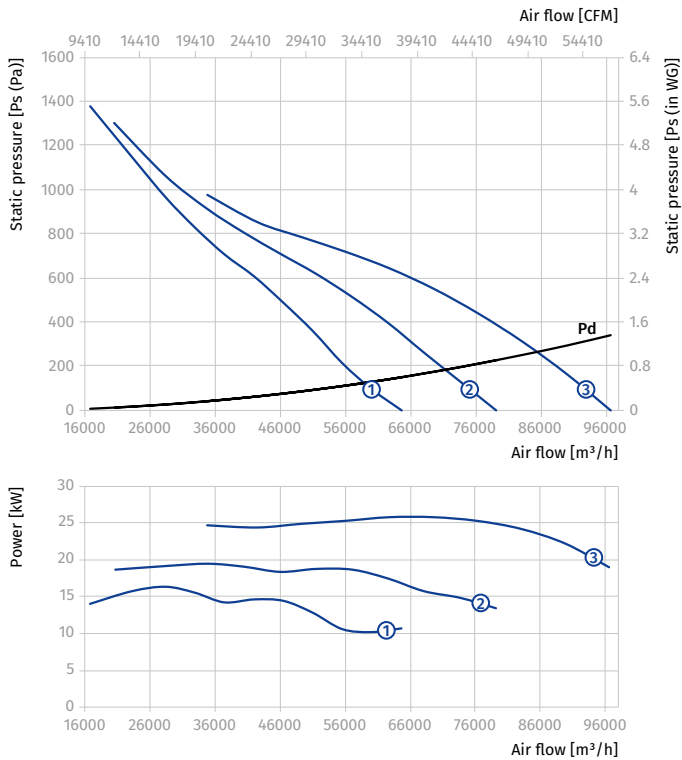

Standard size: 1250
Number of poles: 6
Fire resistance rating: 400/2

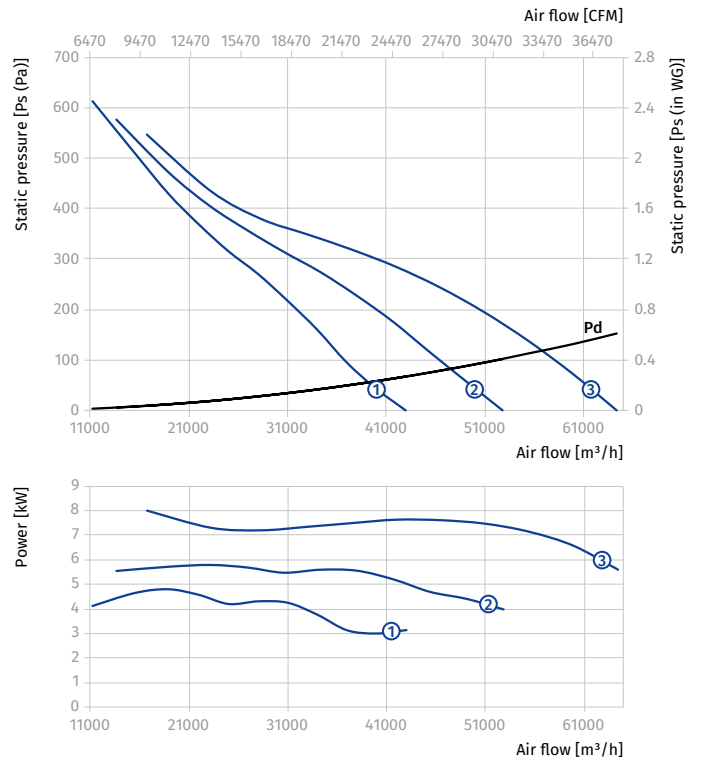

AXIS-FP 1250...400/2

Size	Number of poles	Voltage [V/50 Hz]	Fan model	Installed motor power N_y [kW]	RPM [min^{-1}]	Number of blades	Blade setting angle [°]	Weight [kg]	Length L [mm]	Curve number on graph
Axis-FP 1250-4/8D...400/2										
1250	4/8	3~400	Axis-FP 1250-4/8D/17/4.3-8/21/AL	17/4.3	1440/720	8	21	380	800	①
			Axis-FP 1250-4/8D/20/5-8/25/AL	20/5	1440/720	8	25	408	800	②
			Axis-FP 1250-4/8D/28/6.5-8/32/AL	28/6.5	1440/720	8	32	469	850	③

Standard size: 1250
 Number of poles: 4
 Fire resistance rating: 400/2

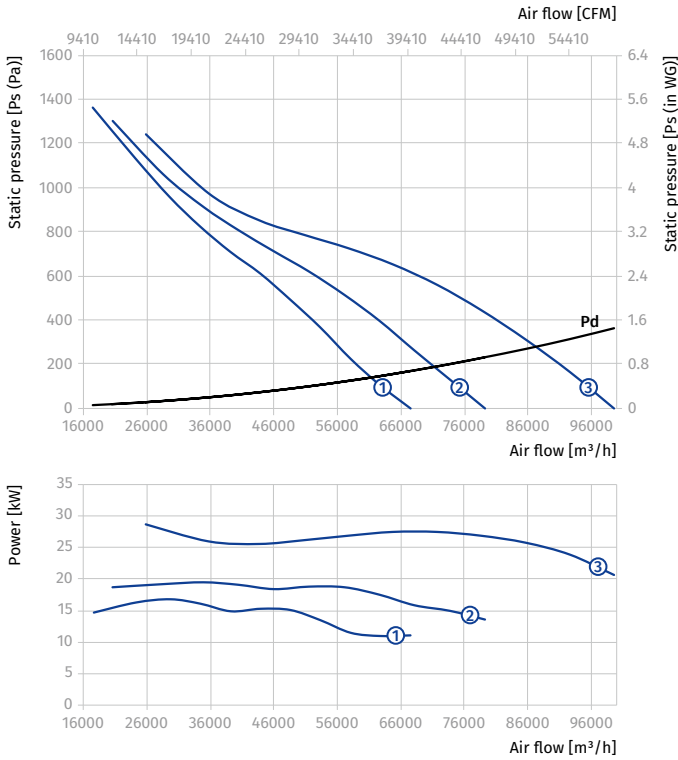

Standard size: 1250
 Number of poles: 8
 Fire resistance rating: 400/2

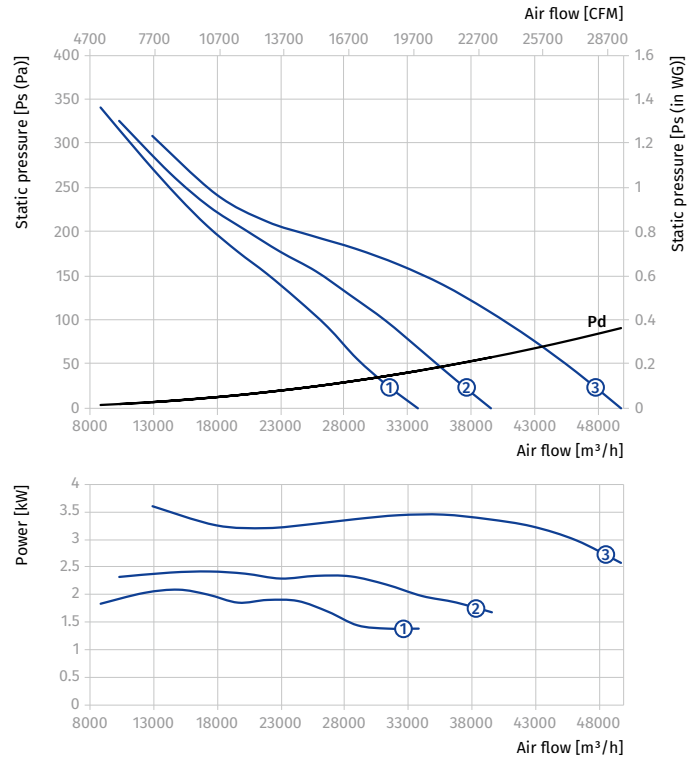

AXIAL SMOKE EXTRACTION FANS