

Axis-F

Axial inline fans

Use

- Supply and extract ventilation systems installed in various premises.
- Ideal solution for boosting large air volumes at low aerodynamic resistance in the ventilation system.



Air flow:
up to 25000 m³/h
6945 l/s



Power:
from 50 W



Noise level:
from 38 dBA



Design

- Compact steel casing and impeller with a special polymer coating.
- Casing is equipped with connecting flanges for easy mounting into air duct.
- The fan is equipped with a terminal block for connection to power mains.

Motor

- Two-, four- or six-pole asynchronous motor with external rotor and axial impeller.
- Single-phase (E) or three-phase (D) motor modifications.
- Equipped with ball bearings for longer service life.
- Integrated thermal protection with automatic restart.

Speed control

- Smooth speed control with an external thyristor controller or step speed control with an external auto transformer (both available upon separate order).

Mounting

- The fan is installed in air ducts by connecting flanges on the fan casing.
- Power is supplied through an external terminal box.

Designation key

Series	Dimension type	Motor Number of poles	Phase
Axis-F	200; 250; 300; 350; 400; 450; 500; 550; 630; 710; 800	2; 4; 6	E: single-phase D: three-phase

Accessories

Flexible antivibration connectors

Speed controllers



EVAF



CDT E1.8

Overall dimensions [mm]

Type	Ø D	Ø D1	Ø D2	Ø d	B	L	Weight [kg]
Axis-F 200 2E	205	235	255	7.0	290	120	3.0
Axis-F 250 2E	260	286	306	7.0	340	150	3.9
Axis-F 250 4E	260	286	306	7.0	340	150	4.0
Axis-F 300 2E	310	356	382	7.0	410	160	6.2
Axis-F 300 4E	310	356	382	7.0	410	160	6.2
Axis-F 350 4E	362	395	421	9.5	450	160	7.7
Axis-F 400 4E	412	438	465	9.5	500	170	8.1
Axis-F 450 4E	462	487	515	9.5	550	200	9.1
Axis-F 500 4E	515	541	570	9.5	600	220	11.0
Axis-F 550 4E	565	605	636	11.5	660	230	13.9
Axis-F 630 4E	645	674	715	11.5	740	250	16.4
Axis-F 250 2D	260	286	306	7.0	340	150	3.9
Axis-F 250 4D	260	286	306	7.0	340	150	4.0
Axis-F 300 2D	310	356	382	7.0	410	160	5.7
Axis-F 300 4D	310	356	382	7.0	410	160	6.2
Axis-F 350 4D	362	395	421	9.5	450	160	7.7
Axis-F 400 4D	412	438	465	9.5	500	170	8.1
Axis-F 450 4D	462	487	515	9.5	550	200	9.1
Axis-F 500 4D	515	541	570	9.5	600	220	11.0
Axis-F 550 4D	565	605	636	11.5	660	230	13.9
Axis-F 630 4D	645	674	715	11.5	740	250	16.4
Axis-F 710 6D	725	767	805	11.5	835	250	30.0
Axis-F 800 6D	800	845	880	11.5	910	280	40.0

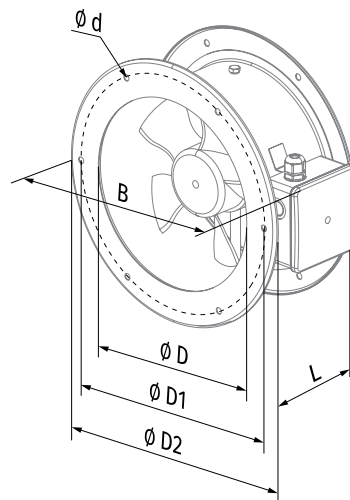

Technical data

Parameters	Axis-F 200 2E		Axis-F 250 2E		Axis-F 250 4E		Axis-F 300 2E		Axis-F 300 4E		Axis-F 350 4E		Axis-F 400 4E	
Voltage [V]	1 ~ 230		1 ~ 230		1 ~ 230		1 ~ 230		1 ~ 230		1 ~ 230		1 ~ 230	
Frequency [Hz]	50	60	50	60	50	60	50	60	50	60	50	60	50	60
Power [W]	55	61	80	91	50	56	145	178	75	92	140	147	180	240
Current [A]	0.26	0.28	0.4	0.42	0.22	0.24	0.66	0.79	0.35	0.4	0.65	0.66	0.82	1.08
Maximum air flow [m³/h (l/s)]	860 (239)	875 (243)	1050 (292)	1150 (319)	800 (222)	865 (240)	2230 (619)	2280 (633)	1340 (372)	1475 (410)	2500 (695)	2650 (736)	3580 (995)	3890 (1081)
RPM [min ⁻¹]	2300	2550	2400	2990	1380	1730	2300	2410	1350	1405	1380	1700	1380	1655
Sound pressure at 3 m [dBA]	48	49	50	51	38	39	53	54	44	45	46	47	53	54
Transported air temperature [°C]	-30...+60		-30...+50		-30...+60		-30...+50		-30...+60		-30...+50		-30...+60	
IP rating	IPX4		IPX4		IPX4		IPX4		IPX4		IPX4		IPX4	
Motor IP rating	IP44		IP44		IP44		IP44		IP44		IP54		IP54	

AXIS-F 200 2E

Sound power level, A-weighted	Total	Octave frequency bands [Hz]								LpA 3 m	LpA 1 m
		63	125	250	500	1000	2000	4000	8000		
LWA to environment [dBA]	68	28	39	52	58	66	62	57	50	48	58

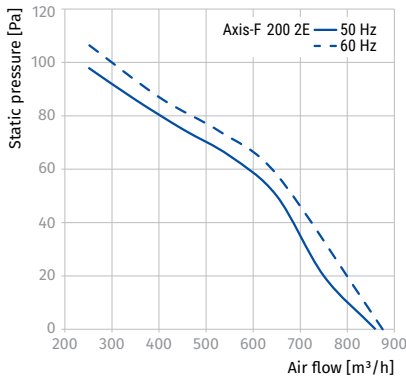

AXIS-F 250 2E, AXIS-F 250 4E

Sound power level, A-weighted	Total	Octave frequency bands [Hz]								LpA 3 m	LpA 1 m
		63	125	250	500	1000	2000	4000	8000		
LWA to environment [dBA]	70	29	40	54	60	68	64	59	52	50	60
LWA to environment [dBA]	59	25	39	43	49	54	54	49	43	38	48

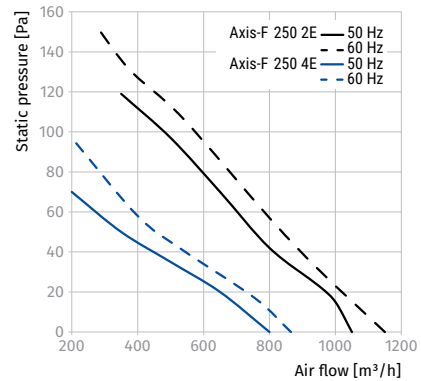

AXIS-F 300 2E, AXIS-F 300 4E

Sound power level, A-weighted	Total	Octave frequency bands [Hz]								LpA 3 m	LpA 1 m
		63	125	250	500	1000	2000	4000	8000		
LWA to environment [dBA]	74	40	49	63	63	71	67	60	56	53	63
LWA to environment [dBA]	64	41	52	47	54	60	60	52	44	44	54

AXIS-F 300 2E

η [%]	MC	EC	N	VSD	[kW]	[A]	[m³/h]	[Pa]	[RPM]	SR
30.5	A	Static	42.2	No	0.141	0.64	1380	110	2350	1

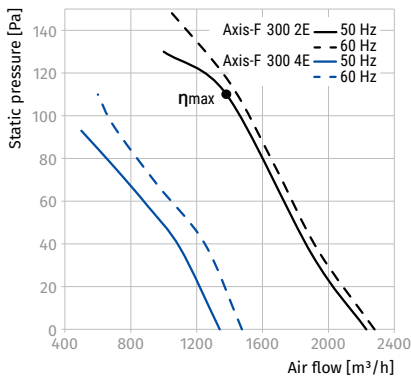

AXIS-F 350 4E, AXIS-F 400 4E

Sound power level, A-weighted	Total	Octave frequency bands [Hz]								LpA 3 m	LpA 1 m
		63	125	250	500	1000	2000	4000	8000		
LWA to environment [dBA]	67	26	43	49	60	62	62	53	46	46	56
LWA to environment [dBA]	73	46	52	58	65	68	68	65	57	53	63

AXIS-F 350 4E

η [%]	MC	EC	N	VSD	[kW]	[A]	[m³/h]	[Pa]	[RPM]	SR
29.9	A	Static	41.8	No	0.130	0.6	1717	80	1375	1

AXIS-F 400 4E

η [%]	MC	EC	N	VSD	[kW]	[A]	[m³/h]	[Pa]	[RPM]	SR
33.8	A	Static	44.8	No	0.187	0.86	2787	80	1355	1

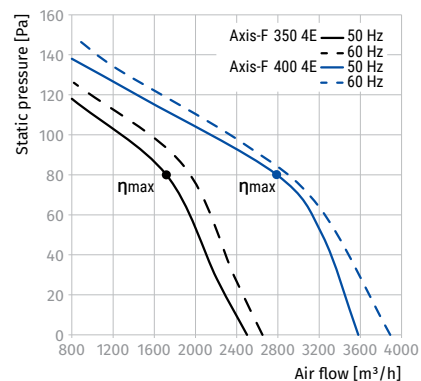

Parameters	Axis-F 450 4E		Axis-F 500 4E		Axis-F 550 4E		Axis-F 630 4E	
Voltage [V]	1 ~ 230		1 ~ 230		1 ~ 230		1 ~ 230	
Frequency [Hz]	50	60	50	60	50	60	50	60
Power [W]	250	325	420	455	550	654	750	979
Current [A]	1.2	1.46	1.95	2.05	2.55	2.88	3.5	4.26
Maximum air flow [m³/h (l/s)]	4680 (1300)	4790 (1331)	7060 (1961)	7130 (1981)	8800 (2445)	8970 (2492)	11900 (3306)	12100 (3361)
RPM [min⁻¹]	1350	1600	1300	1630	1300	1580	1360	1625
Sound pressure at 3 m [dBA]	56	57	58	59	62	63	67	68
Transported air temperature [°C]	-30...+60		-30...+60		-30...+60		-30...+60	
IP rating	IPX4		IPX4		IPX4		IPX4	
Motor IP rating	IP54		IP54		IP54		IP54	

AXIS-F 450 4E

Sound power level, A-weighted	Total	Octave frequency bands [Hz]								LpA 3 m	LpA 1 m
		63	125	250	500	1000	2000	4000	8000		
LWA to environment [dBA]	76	46	57	64	70	72	70	66	58	56	66
η [%]	MC	EC	N	VSD	[kW]	[A]	[m³/h]	[Pa]	[RPM]	SR	
32.0	A	Static	41.8	No	0.288	1.31	3610	90	1270	1	

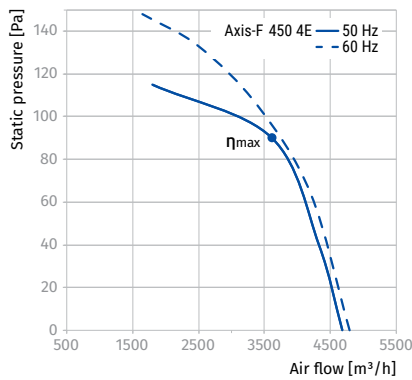

AXIS-F 500 4E

Sound power level, A-weighted	Total	Octave frequency bands [Hz]								LpA 3 m	LpA 1 m
		63	125	250	500	1000	2000	4000	8000		
LWA to environment [dBA]	79	49	60	67	73	74	73	68	60	58	68
η [%]	MC	EC	N	VSD	[kW]	[A]	[m³/h]	[Pa]	[RPM]	SR	
32.1	A	Static	40.7	No	0.440	2.01	4987	100	1285	1	

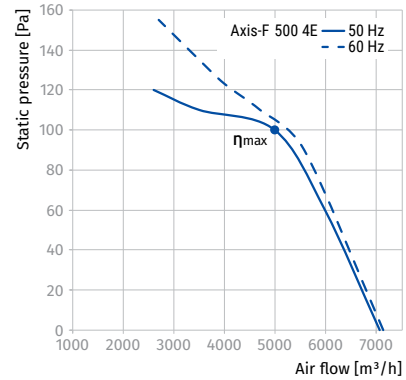

AXIS-F 550 4E

Sound power level, A-weighted	Total	Octave frequency bands [Hz]								LpA 3 m	LpA 1 m
		63	125	250	500	1000	2000	4000	8000		
LWA to environment [dBA]	83	52	64	71	77	78	77	72	64	62	72
η [%]	MC	EC	N	VSD	[kW]	[A]	[m³/h]	[Pa]	[RPM]	SR	
34.7	A	Static	42.6	No	0.581	2.64	5919	120	1240	1	

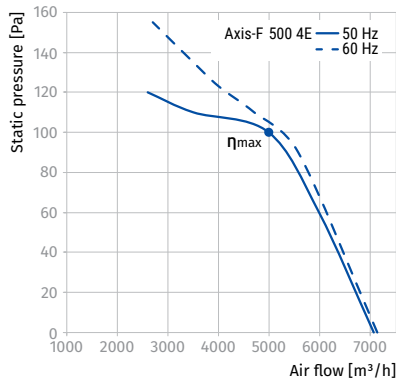

AXIS-F 630 4E

Sound power level, A-weighted	Total	Octave frequency bands [Hz]								LpA 3 m	LpA 1 m
		63	125	250	500	1000	2000	4000	8000		
LWA to environment [dBA]	88	57	68	76	81	83	82	77	69	67	77
η [%]	MC	EC	N	VSD	[kW]	[A]	[m³/h]	[Pa]	[RPM]	SR	
37.5	A	Static	44.4	No	0.800	3.76	7095	149	1290	1	

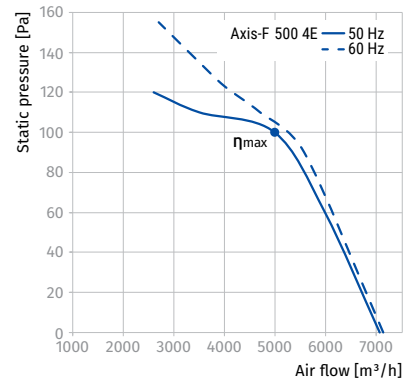

AXIAL FANS

Parameters	Axis-F 250 2D		Axis-F 250 4D		Axis-F 300 2D		Axis-F 300 4D	
Voltage [V]	3 ~ 400		3 ~ 400		3 ~ 400		3 ~ 400	
Frequency [Hz]	50	60	50	60	50	60	50	60
Power [W]	80	92	60	89	145	165	75	94
Current [A]	0.22	0.24	0.17	0.22	0.25	0.29	0.22	0.25
Maximum air flow [m ³ /h (l/s)]	1060 (294)	1150 (319)	850 (236)	885 (246)	2310 (642)	2390 (664)	1310 (364)	1530 (425)
RPM [min ⁻¹]	2600	3030	1400	1750	2350	2570	1380	1640
Sound pressure at 3 m [dBA]	51	52	38	38	52	52	45	45
Transported air temperature [°C]	-30...+60		-30...+60		-30...+60		-30...+60	
IP rating	IPX4		IPX4		IPX4		IPX4	
Motor IP rating	IP44		IP44		IP44		IP44	

AXIS-F 250 2D, AXIS-F 250 4D

Sound power level, A-weighted	Total	Octave frequency bands [Hz]								LpA 3 m	LpA 1 m
		63	125	250	500	1000	2000	4000	8000		
Axis-F 250 2D											
LWA to environment [dBA]	71	29	41	55	61	69	65	60	52	51	61
Axis-F 250 4D											
LWA to environment [dBA]	59	25	39	43	49	54	54	49	43	38	48

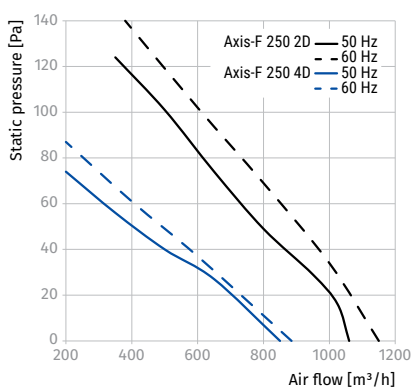
AXIS-F 300 2D, AXIS-F 300 4D

Sound power level, A-weighted	Total	Octave frequency bands [Hz]								LpA 3 m	LpA 1 m
		63	125	250	500	1000	2000	4000	8000		
Axis-F 300 2D											
LWA to environment [dBA]	73	39	48	62	62	70	66	60	55	52	62
Axis-F 300 4D											
LWA to environment [dBA]	65	42	53	46	55	61	61	53	44	45	55

AXIS-F 300 2D

η [%]	MC	EC	N	VSD	[kW]	[A]	[m ³ /h]	[Pa]	[RPM]	SR
30.3	A	Static	42	No	0.141	0.25	1367	110	2350	1

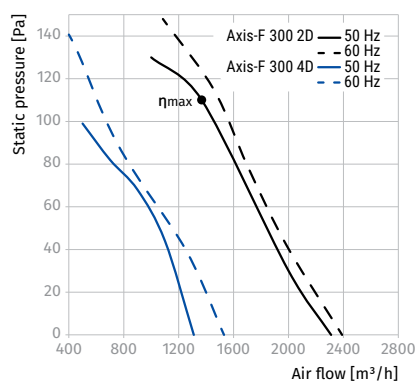

Parameters	Axis-F 350 4D		Axis-F 400 4D		Axis-F 450 4D	
Voltage [V]	3 ~ 400		3 ~ 400		3 ~ 400	
Frequency [Hz]	50	60	50	60	50	60
Power [W]	140	150	180	195	250	275
Current [A]	0.38	0.46	0.47	0.55	0.6	0.65
Maximum air flow [m³/h (l/s)]	2350 (653)	2660 (739)	3740 (1039)	3870 (1075)	5280 (1467)	5350 (1486)
RPM [min⁻¹]	1419	1638	1380	1625	1360	1620
Sound pressure at 3 m [dBA]	46	46	54	54	56	56
Transported air temperature [°C]	-30...+60		-30...+60		-30...+60	
IP rating	IPX4		IPX4		IPX4	
Motor IP rating	IP54		IP54		IP54	

AXIS-F 350 4D, AXIS-F 400 4D

Sound power level, A-weighted	Total	Octave frequency bands [Hz]								LpA 3 m	LpA 1 m
		63	125	250	500	1000	2000	4000	8000		
Axis-F 350 4D											
LWA to environment [dBA]	66	26	43	48	59	62	62	53	46	46	56
Axis-F 400 4D											
LWA to environment [dBA]	74	31	48	58	63	70	70	66	58	54	64

AXIS-F 350 4D

η [%]	MC	EC	N	VSD	[kW]	[A]	[m³/h]	[Pa]	[RPM]	SR
31.7	A	Static	43.7	No	0.129	0.37	1802	80	1400	1

AXIS-F 400 4D

η [%]	MC	EC	N	VSD	[kW]	[A]	[m³/h]	[Pa]	[RPM]	SR
34.3	A	Static	44.9	No	0.209	0.47	2807	90	1365	1

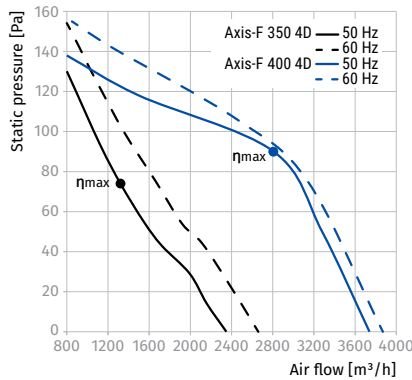

AXIS-F 450 4D

Sound power level, A-weighted	Total	Octave frequency bands [Hz]								LpA 3 m	LpA 1 m
		63	125	250	500	1000	2000	4000	8000		
LWA to environment [dBA]	77	48	60	67	70	71	72	67	59	56	66
η [%]	MC	EC	N	VSD	[kW]	[A]	[m³/h]	[Pa]	[RPM]	SR	
35.1	A	Static	44.8	No	0.296	0.59	3659	100	1310	1	

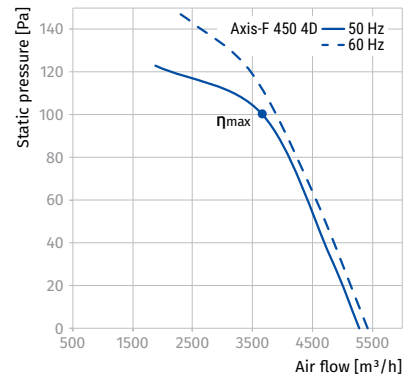

Parameters	Axis-F 500 4D		Axis-F 550 4D		Axis-F 630 4D		Axis-F 710 6D
Voltage [V]	3 ~ 400		3 ~ 400		3 ~ 400		3 ~ 400
Frequency [Hz]	50	60	50	60	50	60	50
Power [W]	450	370	750	600	800	910	1150
Current [A]	0.9	0.7	1.5	1.1	1.6	1.68	2.0
Maximum air flow [m³/h (l/s)]	6570 (1825)	6230 (1731)	9700 (2695)	7380 (2050)	12200 (3389)	12400 (3445)	15440 (4289)
RPM [min⁻¹]	1300	1605	1350	1605	1320	1585	830
Sound pressure at 3 m [dBA]	60		64		69		63
Transported air temperature [°C]	-30...+60		-30...+50		-30...+60		-30...+50
IP rating	IPX4		IPX4		IPX4		IPX4
Motor IP rating	IP54		IP54		IP54		IP54

AXIS-F 500 4D

Sound power level, A-weighted	Total	Octave frequency bands [Hz]								LpA 3 m	LpA 1 m
		63	125	250	500	1000	2000	4000	8000		
L _{WA} to environment [dBA]	81	51	63	70	74	75	76	71	62	60	70
η [%]	MC	EC	N	VSD	[kW]	[A]	[m³/h]	[Pa]	[RPM]	SR	
35.5	A	Static	43.9	No	0.478	0.9	4988	120	1305	1	

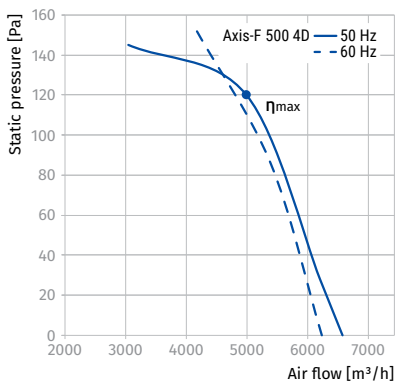

AXIS-F 550 4D

Sound power level, A-weighted	Total	Octave frequency bands [Hz]								LpA 3 m	LpA 1 m
		63	125	250	500	1000	2000	4000	8000		
L _{WA} to environment [dBA]	85	53	65	72	79	80	79	73	65	64	74
η [%]	MC	EC	N	VSD	[kW]	[A]	[m³/h]	[Pa]	[RPM]	SR	
38.8	A	Static	46.3	No	0.656	1.27	6400	140	1175	1	

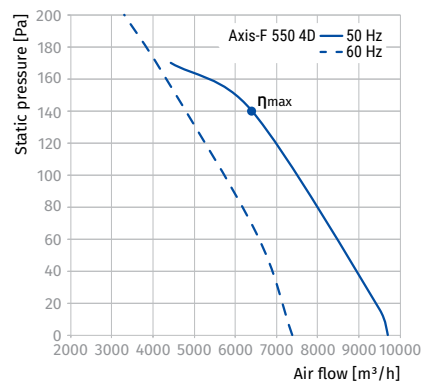

AXIS-F 630 4D

Sound power level, A-weighted	Total	Octave frequency bands [Hz]								LpA 3 m	LpA 1 m
		63	125	250	500	1000	2000	4000	8000		
L _{WA} to environment [dBA]	90	58	69	78	83	85	84	79	70	69	79
η [%]	MC	EC	N	VSD	[kW]	[A]	[m³/h]	[Pa]	[RPM]	SR	
41.2	A	Static	48.1	No	0.810	1.61	7743	152	1290	1	

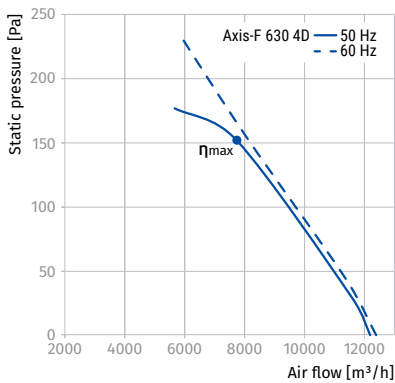

AXIS-F 710 6D

Sound power level, A-weighted	Total	Octave frequency bands [Hz]								LpA 3 m	LpA 1 m
		63	125	250	500	1000	2000	4000	8000		
L _{WA} to environment [dBA]	83	54	65	72	78	79	77	70	62	63	73
η [%]	MC	EC	N	VSD	[kW]	[A]	[m³/h]	[Pa]	[RPM]	SR	
35.6	A	Static	42	No	0.979	1.91	8777	140	830	1	

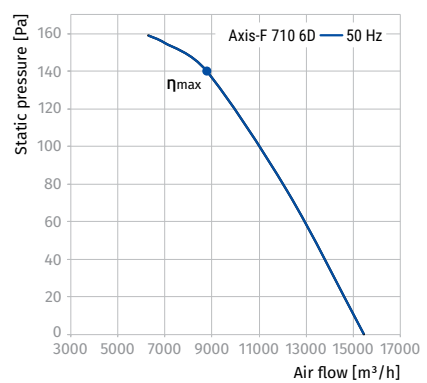

Parameters	Axis-F 800 6D
Voltage [V]	3 ~ 400
Frequency [Hz]	50
Power [W]	1850
Current [A]	3.7
Maximum air flow [m³/h (l/s)]	25000 (6945)
RPM [min ⁻¹]	915
Sound pressure at 3 m [dBA]	67
Transported air temperature [°C]	-30...+60
IP rating	IPX4
Motor IP rating	IP54

AXIS-F 800 6D

Sound power level, A-weighted	Total	Octave frequency bands [Hz]								LpA 3 m	LpA 1 m
		63	125	250	500	1000	2000	4000	8000		
L _{WA} to environment [dBA]	88	57	69	77	82	83	81	74	65	67	77

η [%]	MC	EC	N	VSD	[kW]	[A]	[m³/h]	[Pa]	[RPM]	SR
31.6	A	Static	36.6	No	1.650	3.6	17040	108	915	1

