

# *Aero*

---

*User's manual*



**BLAUBERG**  
*Ventilatoren*

**BLAUBERG Company is happy to offer your attention a new high-quality Blauberg Aero fan. The solid team of high-qualified professionals with many years of working experience, technological innovations in design and production, high-quality components and materials from the top worldwide producers have become the precondition for the best fan in its class.**

## **Introduction**

The present user's manual contains a technical description, technical data sheets, operation and mounting guidelines, safety precautions and warnings for safe and correct operation of the Aero fan.

## **Purpose**

The Aero fan is designed for ventilation of residential and public spaces heated during winter season. The fan is designed for wall or ceiling mounting (Fig. 3-5).

The fan is equipped with a non-return valve to prevent back air flow during the fan standby.

## **Delivery set**

- Fan – 1 pc.
- Screws and dowels – 4 pcs.
- Plastic screwdriver (for the models with a timer) – 1 pc.
- User's manual
- Packing box

*The fan design is regularly improved, so some models may slightly differ from those ones described herein.*

## Technical data

The fan designations, parameters, outer view, overall and connecting dimensions are shown in Tables 1, 2, 3 and in Fig. 1 and 2.

**Table 1**

Model	Maximum air flow [m <sup>3</sup> /h]	Rated power [W]	RPM [min <sup>-1</sup> ]	Noise level [dBA]
Aero 100	102	14	2300	38
Aero 125	193	16	2400	39
Aero 150	309	24	2400	40
Aero Still 100	84	5.5	1900	25
Aero Still 125	158	9.4	1900	31
Aero Still 150	254	19	1900	33

**Table 2**

Model	Switch	Timers	Humidity sensor	Motion sensor
Aero __				
Aero __ S	●			
Aero __ T		●		
Aero __ ST	●	●		
Aero __ H		●	●	
Aero __ SH	●	●	●	
Aero __ IR		●		●

**Switch (S)** – built-in pull cord switch.

**Timer (T)** – turn-off delay time from 2 to 30 minutes.

**Humidity sensor (H)** – threshold value from 60 % to 90 %.

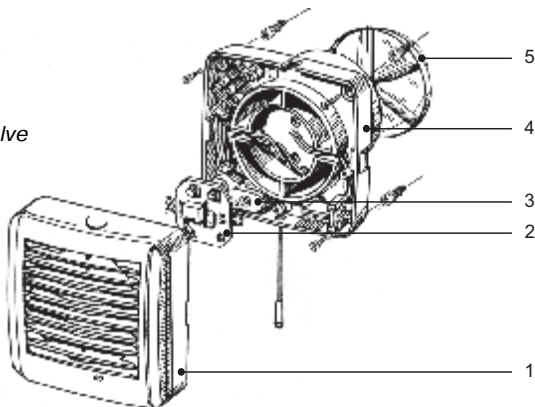
**Motion sensor (IR)** – detection area from 1 to 4 m and sensor viewing angle up to 100°.

The fan does not cause interference to radio, television or video equipment.

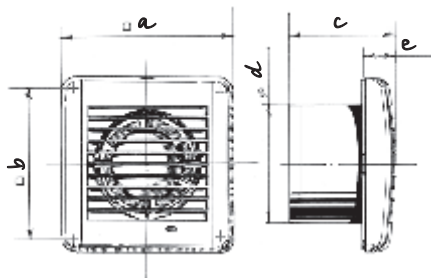
Service life is not less than 5 years.

**Figure 1**

- 1 – cover
- 2 – timer
- 3 – switch
- 4 – casing
- 5 – non-return valve

**Table 3**

Model	Dimensions [mm]					Weight [kg]
	a	b	c	d	e	
Aero 100	144	122	92,5	100	29,5	0,56
Aero 125	168	144	97	125	30	0,73
Aero 150	198	170	119	150	30	0,9

**Figure 2**

## **Operation guidelines**

The fan is connected to 220...240 V/50 Hz single-phase AC mains and is designed for continuous operation without disconnection from the electric mains.

Airflow direction must be in compliance with the direction of the arrow on the fan casing.

The fan is rated for operation at the ambient temperature ranging from +1 °C up to +45 °C.

The unit is rated as a Class II electrical appliance.

## **Safety requirements**

Disconnect the unit from power supply prior to any connection, servicing and repair operations.

All mounting and servicing operations should be performed by duly qualified electricians with valid electrical work permit for works with electrical devices powered from AC up to 1000 V and after careful study of the present User's manual.

Single-phase power mains must comply with the acting local electrical norms and standards. Fixed electrical wiring must be equipped with an automatic circuit breaker. The unit must be connected to power mains through an automatic circuit breaker integrated into the fixed wiring system.

The gap between the circuit breaker contacts on all poles must be not less than 3 mm.

Check the fan for any visible damages of the impeller and the casing before starting installation. The casing internals must be free of any foreign objects which can damage the impeller blades.

Misuse of the unit and any unauthorized modifications are not allowed.

The unit is not allowed for use by children and persons with reduced physical, mental or sensory capacities, without proper practical experience or expertise, unless they are controlled or instructed on the product operation by the person(s) responsible for their safety.

Supervise the children and do not let them play with the unit.

Take steps to prevent ingress of smoke, carbon monoxide, and other combustion products into the room through open chimney flues or other fire-protection devices. Sufficient air supply must be provided for proper combustion and exhaust of gases through the chimney of fuel burning equipment to prevent back drafting.

The transported air must not contain any dust or other solid impurities, sticky substances or fibrous materials.

The fan is not rated for operation in a media that contains hazardous or explosive materials and vapours, i.e. spirits, gasoline, insecticides, etc. Do not close or block the fan intake or extract vents in order to ensure the efficient air stream.

Do not sit on the unit and do not put objects on it.

Following the regulations stipulated herein will ensure a long and trouble-free operation of the unit.

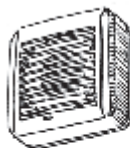
## Installation and set-up

The fan mounting sequence is shown in Fig. 8-9.  
The fan wiring diagrams are shown in Fig. 10-16.

**Figure 3**



**Figure 4**



**Figure 5**

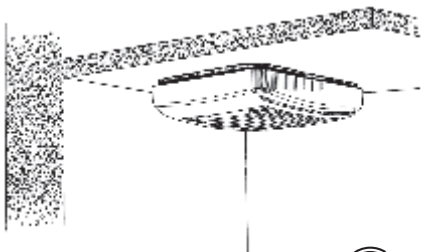


Figure 6

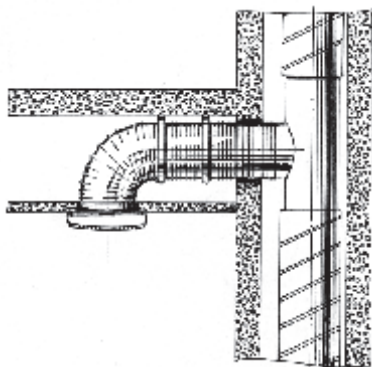


Figure 7

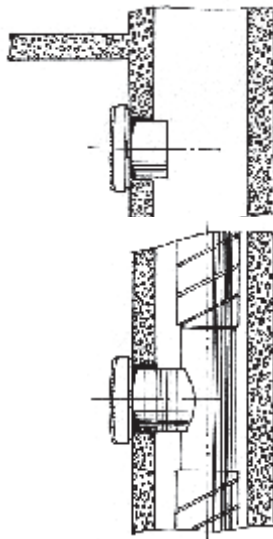


Figure 8

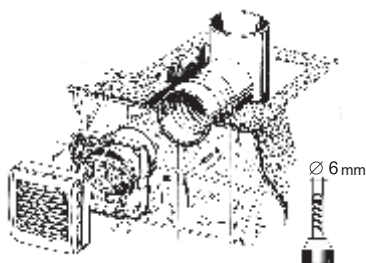
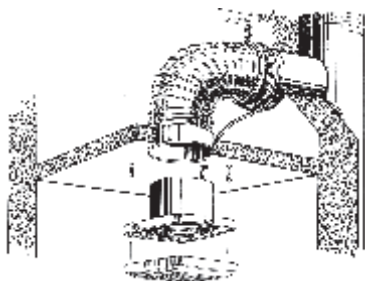


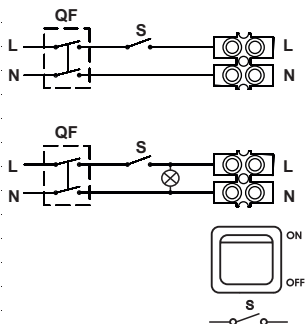
Figure 9





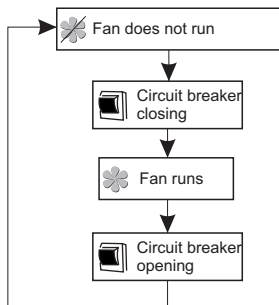
## Wiring diagrams and operation algorithms of the fan

Aero \_\_\_\_\_

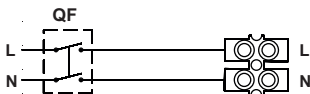


S – external switch  
 QF – automatic circuit breaker

Figure 10

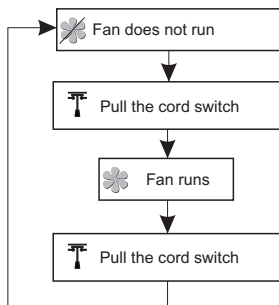


Aero \_\_\_\_\_ S

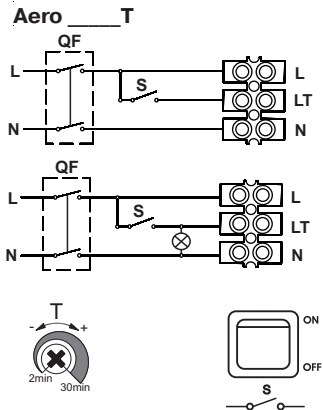


QF – automatic circuit breaker

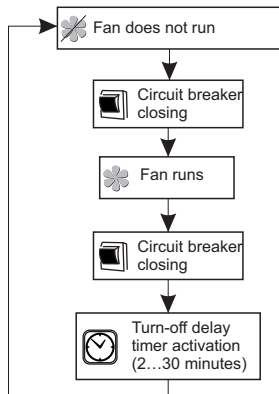
Figure 11



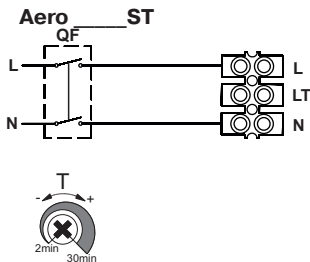
**Figure 12**



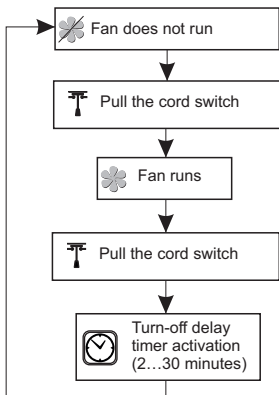
S – external switch  
QF – automatic circuit breaker

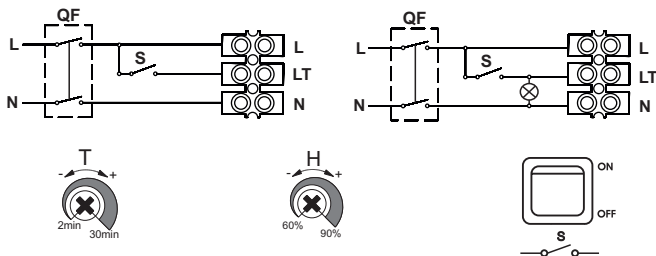


**Figure 13**



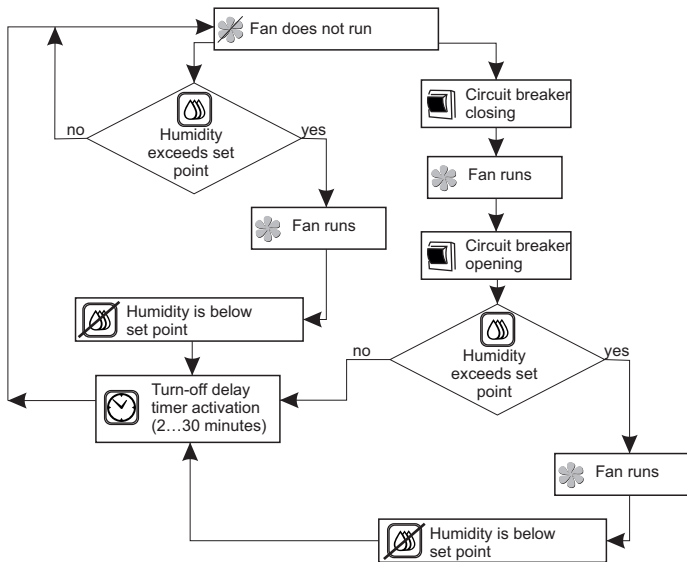
QF – automatic circuit breaker

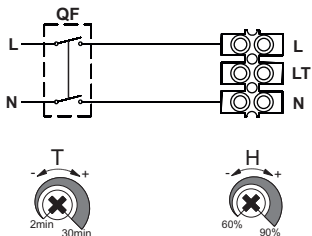




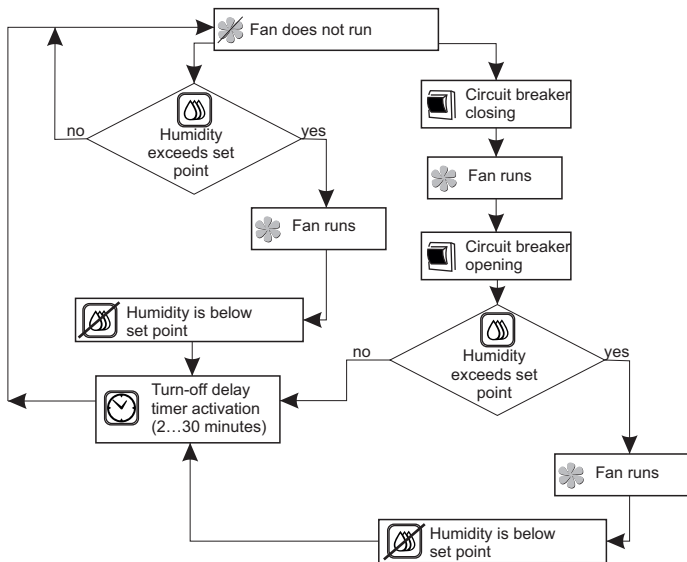
S – external switch

QF – automatic circuit breaker

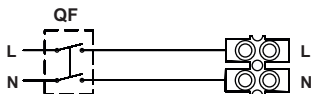




QF – automatic circuit breaker



## Aero \_\_\_ IR



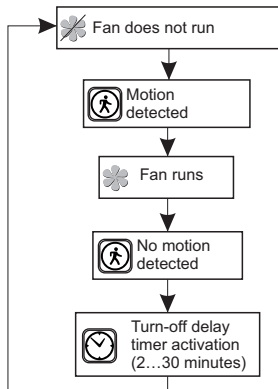
QF – automatic circuit breaker

### **WARNING!**

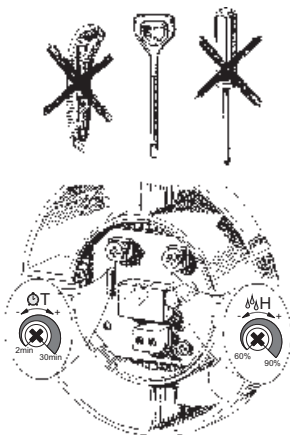
The timer circuit is live!  
Disconnect the fan from power supply prior to any adjustment operations. The fan delivery set includes a specially designed plastic screwdriver for fan settings adjustments. Use it to change the turn-off delay time or to set the humidity set point.

**Do not use a metal screwdriver, knife, etc. for adjustment operations not to damage the circuit board.**

**Figure 16**



**Figure 17**



## **Technical maintenance**

Disconnect the fan from power supply prior to maintenance and servicing operations. The technical maintenance includes periodic cleaning of the surfaces from accumulated dust and dirt.

To clean the fan, wipe its surfaces with a cloth or a brush wetted in a mild soap solution, then wipe the surfaces dry. Avoid penetration of water inside the electric motor and other electric parts.

## **Transportation and storage regulations**

Transportation with any transportation vehicle in the manufacturer's original package.

Store the fan in the manufacturer's original packing box in a dry ventilated premise at ambient temperatures from +5 °C up to + 40 °C and relative humidity below 80 %. Storage environment must not contain aggressive vapours and chemical mixtures provoking corrosion.



*THE PRODUCT MUST BE DISPOSED  
SEPARATELY AT THE END OF ITS SERVICE LIFE.*

*DO NOT DISPOSE THE UNIT AS UNSORTED  
DOMESTIC WASTE.*

**CAUTION!!!** To benefit from warranty repair, the user must provide the unit, the user's manual with the purchase date stamp, and the payment paperwork certifying the purchase. In the event that the sale date stamp is not available warranty period is calculated from the manufacturing date.

**By purchasing this product the customer confirms to have read and agreed to the terms, rules and requirements related to operation, storage, transportation, mounting, adjustment, connection, maintenance and repair as well as warranty obligations with respect to this product as set forth in the manufacturer's accompanying documentation to the product.**

### **Manufacturer's warranty**

The product is in compliance with EU norms and standards on low voltage guidelines and electromagnetic compatibility. We hereby declare that the following product complies with the essential protection requirements of Electromagnetic Compatibility (EMC) Directive 2014/30/EU of the European Parliament and of the Council and Low Voltage Directive (LVD) 2014/35/EU of the European Parliament and of the Council and CE-marking Council Directive 93/68/EEC. This certificate is issued following test carried out on samples of the product referred to above.

The manufacturer hereby warrants normal operation of the unit for 24 months after the retail sale date provided the user's observance of the transportation, storage, installation, and operation regulations. Should any malfunctions occur in the course of the unit operation through the Manufacturer's fault during the guaranteed period of operation, the user is entitled to get all the faults eliminated by the manufacturer by means of warranty repair at the factory free of charge. The warranty repair includes work specific to elimination of faults in the unit operation to ensure its intended use by the user within the guaranteed period of operation. The faults are eliminated by means of replacement or repair of the unit components or a specific part of such unit component.

### **The warranty repair does not include:**

- routine technical maintenance
- unit installation/dismantling
- unit setup

To benefit from warranty repair, the user must provide the unit, the user's manual with the purchase date stamp, and the payment paperwork certifying the purchase. The unit model must comply with the one stated in the user's manual. Contact the Seller for warranty service.

### **The manufacturer's warranty does not apply to the following cases:**

- User's failure to submit the unit with the entire delivery package as stated in the user's manual including submission with missing component parts previously dismantled by the user.
- Mismatch of the unit model and the brand name with the information stated on the unit packaging and in the user's manual.
- User's failure to ensure timely technical maintenance of the unit.
- External damage to the unit casing (excluding external modifications as required for installation) and internal components caused by the user.
- Redesign or engineering changes to the unit.
- Replacement and use of any assemblies, parts and components not approved by the manufacturer.
- Unit misuse.
- Violation of the unit installation regulations by the user.
- Violation of the unit control regulations by the user.
- Unit connection to power mains with a voltage different from the one stated in the user's manual.
- Unit breakdown due to voltage surges in power mains.
- Discretionary repair of the unit by the user.
- Unit repair by any persons without the manufacturer's authorization.
- Expiration of the unit warranty period.
- Violation of the unit transportation regulations by the user.
- Violation of the unit storage regulations by the user.
- Wrongful actions against the unit committed by third parties.
- Unit breakdown due to circumstances of insuperable force (fire,



flood, earthquake, war, hostilities of any kind, blockades).

- Missing seals if provided by the user's manual.
- Failure to submit the user's manual with the unit purchase date stamp.
- Missing payment paperwork certifying the unit purchase.







*Aero*

100

*Aero Still*

125

150

*S*

*T*

*H*

*ST*

*SH*

*IR*

PURCHASE DATE

MANUFACTURE DATE

SELLER

QUALITY INSPECTOR'S STAMP

The fan is recognized as serviceable.

We hereby declare that the product complies with the protection requirements of Electromagnetic Council Directive 2014/30/EU, Low Voltage Directive 2014/35/EU and CE-marking Directive 93/68/EEC on the approximation of the laws of the Member States relating to electromagnetic compatibility.

This certificate is issued following the test on the samples of the product referred to above.

